



E-Class

Coupe

Operator's Manual



2075845402

Order no. 6515 3856 13 Part no. 207 584 54 02 Edition C 2016

E-Class Coupe



Mercedes-Benz

Symbols

Registered trademarks:

- Bluetooth® is a registered trademark of Bluetooth SIG Inc.
- DTS™ is a registered trademark of DTS, Inc.
- Dolby® and MLP™ are registered trademarks of DOLBY Laboratories.
- BabySmart™, ESP® and PRE-SAFE® are registered trademarks of Daimler AG.
- HomeLink® is a registered trademark of Johnson Controls.
- iPod® and iTunes® are registered trademarks of Apple Inc.
- Logic7® is a registered trademark of Harman International Industries.
- Microsoft® and Windows media® are registered trademarks of Microsoft Corporation.
- SIRIUS® is a registered trademark of Sirius XM Radio Inc.
- HD Radio™ is a registered trademark of iBiquity Digital Corporation.
- Gracenote® is a registered trademark of Gracenote, Inc.
- ZAGAT Survey® and related brands are registered trademarks of Zagat Survey, LLC.

In this Operator's Manual you will find the following symbols:

WARNING

Warning notes make you aware of dangers which could pose a threat to your health or life, or to the health and life of others.

Environmental note

Environmental notes provide you with information on environmentally aware actions or disposal.

 Notes on material damage alert you to dangers that could lead to damage to your vehicle.

 Practical tips or further information that could be helpful to you.

- ▶ This symbol indicates an instruction that must be followed.
- ▶ Several of these symbols in succession indicate an instruction with several steps.

 This symbol tells you where you can find more information about a topic.

 This symbol indicates a warning or an instruction that is continued on the next page.

 **Display** This text indicates a message on the multifunction display/multimedia display.

 This symbol tells you that you can find further information in the Digital Operator's Manual.

Publication details

Internet

Further information about Mercedes-Benz vehicles and about Daimler AG can be found on the following websites:

<http://www.mbusa.com> (USA only)

<http://www.mercedes-benz.ca> (Canada only)

Editorial office

©Daimler AG: not to be reprinted, translated or otherwise reproduced, in whole or in part, without written permission from Daimler AG.

Vehicle manufacturer

Daimler AG
Mercedesstraße 137
70327 Stuttgart
Germany

Welcome to the world of Mercedes-Benz

We urge you to read this Operator's Manual carefully and familiarize yourself with the vehicle before driving. For your own safety and a longer vehicle life, follow the instructions and warning notices in this manual. Ignoring them could result in damage to the vehicle or personal injury to you or others.

Vehicle damage caused by failure to follow instructions is not covered by the Mercedes-Benz Limited Warranty.

The equipment or product designation of your vehicle may vary depending on:

- Model
- Order
- Country specification
- Availability

Mercedes-Benz therefore reserves the right to introduce changes in the following areas:

- Design
- Equipment
- Technical features

The equipment in your vehicle may therefore differ from that shown in the descriptions and illustrations.

The following are integral components of the vehicle:

- Digital Operator's Manual
- Printed Operator's Manual
- Maintenance Booklet
- Equipment-dependent supplements

Keep these documents in the vehicle at all times. If you sell the vehicle, always pass all documents on to the new owner.

Your Operator's Manual:

Digital form inside the vehicle

The Digital Operator's Manual provides comprehensive and specifically adapted information on your vehicle's equipment and multimedia system. It contains informative animations, individual language settings and an intuitive search function.

Booklet inside the vehicle

In addition to this manual and the aforementioned digital media, you also have the option to obtain a comprehensive printed version of the Supplement for your multimedia system from your authorized Mercedes-Benz Center.

Digital form via the Internet

The Operator's Manual on the Internet provides easy access to all information regarding your vehicle and multimedia system. It also provides helpful animations, interesting background information and a wide array of search options.

Digital form as an App

Using the Mercedes-Benz Guides App, you can view all the information on your vehicle and multimedia system via mobile Internet or download it independently of network access. Available for smartphones or tablets.



Apple® iOS



Android™

Please note that the Mercedes-Benz Guides App may not yet be available in your country.

Mercedes-Benz USA, LLC
Mercedes-Benz Canada, Inc.
A Daimler Company

Index 3

Digital Operator's Manual 22

Introduction 24

At a glance 32

Safety 40

Opening and closing 73

Seats, steering wheel and mirrors 91

Lights and windshield wipers 103

Climate control 111

Driving and parking 121

On-board computer and displays 184

Multimedia system 229

Stowage and features 235

Maintenance and care 254

Breakdown assistance 266

Wheels and tires 281

Technical data 306

1, 2, 3 ...

| | |
|---|-----|
| 4ETS (Electronic Traction System) | |
| see ETS/4ETS (Electronic Traction System) | |
| 4MATIC (permanent all-wheel drive) | |
| Function/notes | 157 |
| 12 V socket | |
| see Sockets | |
| 360° camera | |
| Cleaning | 262 |
| Display in the multimedia system .. | 171 |
| Function/notes | 169 |

A

| | |
|--|-----|
| ABS (Anti-lock Braking System) | |
| Display message | 198 |
| Function/notes | 62 |
| Important safety notes | 62 |
| Warning lamp | 222 |
| Accident | |
| Automatic measures after an accident | 56 |
| Activating media mode | |
| General notes | 234 |
| Activating/deactivating cooling with air dehumidification | 115 |
| Active Blind Spot Assist | |
| Activating/deactivating (on-board computer) | 193 |
| Display message | 210 |
| Function/information | 178 |
| Active Driving Assistance package .. | 178 |
| Active Lane Keeping Assist | |
| Activating/deactivating (on-board computer) | 193 |
| Display message | 210 |
| Function/information | 181 |
| Active Parking Assist | |
| Detecting parking spaces | 162 |
| Display message | 211 |
| Exiting a parking space | 164 |
| Function/notes | 161 |
| Important safety notes | 161 |
| Parking | 163 |
| ADAPTIVE BRAKE | 69 |
| Adaptive Brake Assist | |
| Function/notes | 66 |
| Adaptive Highbeam Assist | |
| Display message | 206 |
| Function/notes | 105 |
| Switching on/off | 106 |
| Additives (engine oil) | 311 |
| Address book | |
| see also Digital Operator's Manual | 229 |
| Adjusting the volume | |
| Audio 20 | 230 |
| COMAND | 230 |
| Air bags | |
| Deployment | 52 |
| Display message | 204 |
| Front air bag (driver, front passenger) | 46 |
| Important safety notes | 45 |
| Introduction | 45 |
| Knee bag | 47 |
| Occupant Classification System (OCS) | 48 |
| PASSENGER AIR BAG OFF indicator lamp | 41 |
| Pelvis air bag | 47 |
| Side impact air bag | 47 |
| Window curtain air bag | 48 |
| Air vents | |
| Glove box | 120 |
| Important safety notes | 120 |
| Setting | 120 |
| Setting the side air vents | 120 |
| Air-conditioning system | |
| see Climate control | |
| Alarm | |
| ATA (Anti-Theft Alarm system) | 72 |
| Switching off (ATA) | 72 |
| Switching the function on/off (ATA) | 72 |
| Alarm system | |
| see ATA (Anti-Theft Alarm system) | |
| Anti-lock braking system | |
| see ABS (Anti-lock Braking System) | |
| Anti-Theft Alarm system | |
| see ATA (Anti-Theft Alarm system) | |
| Ashtray | 241 |

- Assistance display (on-board computer)** 191
- Assistance menu (on-board computer)** 191
- ASSYST PLUS**
- Displaying a service message 258
 - Hiding a service message 258
 - Resetting the service interval display 258
 - Service message 257
 - Special service requirements 258
- ATA (Anti-Theft Alarm system)**
- Activating/deactivating 72
 - Function 72
 - Switching off the alarm 72
- ATTENTION ASSIST**
- Activating/deactivating 192
 - Display message 209
 - Function/notes 172
- Audio 20**
- Switching on/off 230
- Audio system**
- see separate operating instructions
- Authorized Mercedes-Benz Center**
- see Qualified specialist workshop
- Authorized workshop**
- see Qualified specialist workshop
- AUTO lights**
- Display message 206
 - see Lights
- Automatic car wash (care)** 259
- Automatic engine start (ECO start/stop function)** 125
- Automatic engine switch-off (ECO start/stop function)** 125
- Automatic headlamp mode** 103
- Automatic transmission**
- Accelerator pedal position 130
 - Automatic drive program 132
 - Changing gear 130
 - DIRECT SELECT lever 128
 - Display message 215
 - Drive program display 128
 - Driving tips 130
 - Emergency running mode 135
 - Engaging drive position 129
 - Engaging neutral 129
 - Engaging park position automatically 129
 - Engaging reverse gear 129
 - Engaging the park position 128
 - Kickdown 131
 - Manual drive program 132
 - Manual drive program (vehicles with Sports package AMG) 133
 - Overview 128
 - Problem (malfunction) 135
 - Program selector button 131
 - Pulling away 124
 - Starting the engine 124
 - Steering wheel paddle shifters 132
 - Transmission position display (DIRECT SELECT lever) 128
 - Transmission positions 130
- Automatic transmission emergency mode** 135
- B**
- Back button** 230
- Bag hook** 238
- BAS (Brake Assist System)** 63
- BAS PLUS (Brake Assist System PLUS) with Cross-Traffic Assist**
- Function/notes 63
- BAS PLUS with Cross-Traffic Assist (Brake Assist PLUS with Cross-Traffic Assist)**
- Important safety notes 63
- Battery (SmartKey)**
- Checking 76
 - Important safety notes 75
 - Replacing 76
- Battery (vehicle)**
- Charging 272
 - Display message 208
 - Important safety notes 270
 - Jump starting 274
- Belt**
- see Seat belts
- Blind Spot Assist**
- Activating/deactivating (on-board computer) 193
 - Display message 210
 - Notes/function 175

- see Active Blind Spot Assist
 - Bluetooth®**
 - Connecting another mobile phone 234
 - Searching for a mobile phone 233
 - see also Digital Operator's Manual 229
 - Telephony 232
 - Brake Assist**
 - see BAS (Brake Assist System)
 - Brake fluid**
 - Display message 200
 - Notes 311
 - Brake force distribution**
 - see EBD (electronic brake force distribution)
 - Brake lamps**
 - Display message 206
 - Brakes**
 - ABS 62
 - Adaptive Brake Assist 66
 - BAS 63
 - BAS PLUS with Cross-Traffic Assist 63
 - Brake fluid (notes) 311
 - Display message 198
 - HOLD function 156
 - Important safety notes 142
 - Maintenance 143
 - Parking brake 139
 - Riding tips 142
 - Warning lamp 221
 - Breakdown**
 - Where will I find...? 266
 - see Flat tire
 - Brightness control (instrument cluster lighting)** 33
 - Bulbs**
 - see Replacing bulbs
- C**
- California**
 - Important notice for retail customers and lessees 25
 - Calling up a malfunction**
 - see Display messages
 - Car**
 - see Vehicle
 - Care**
 - 360° camera 262
 - Car wash 259
 - Carpets 265
 - Display 263
 - Exhaust pipe 263
 - Exterior lights 262
 - Gear or selector lever 263
 - Interior 263
 - Matte finish 261
 - Notes 259
 - Paint 260
 - Plastic trim 263
 - Power washer 260
 - Rear view camera 262
 - Roof lining 265
 - Seat belt 264
 - Seat cover 264
 - Sensors 262
 - Steering wheel 263
 - Trim pieces 264
 - Washing by hand 260
 - Wheels 261
 - Windows 261
 - Wiper blades 261
 - Wooden trim 264
 - Cargo tie down rings** 238
 - CD**
 - see also Digital Operator's Manual 229
 - CD player (on-board computer)** 189
 - Center console**
 - Lower section 37
 - Upper section 36
 - Central locking**
 - Automatic locking (on-board computer) 195
 - Locking/unlocking (SmartKey) 73
 - Changing bulbs**
 - High-beam headlamps 108
 - Child**
 - Restraint system 58
 - Child seat**
 - Forward-facing restraint system 60
 - LATCH-type (ISOFIX) child seat anchors 59

- On the front-passenger seat 60
- Rearward-facing restraint system 60
- Top Tether 59
- Child-proof locks**
- Important safety notes 61
- Children**
- Special seat belt retractor 57
- Cigarette lighter** 242
- Cleaning**
- Mirror turn signal 262
- Climate control**
- Automatic climate control (3-zone) 113
- Controlling automatically 115
- Cooling with air dehumidification .. 115
- Defrosting the windows 118
- Defrosting the windshield 117
- Dual-zone automatic climate control 112
- General notes 111
- Indicator lamp 115
- Information about using automatic climate control 114
- Maximum cooling 117
- Overview of systems 111
- Problem with the rear window defroster 119
- Problems with cooling with air dehumidification 115
- Rear control panel 113
- Refrigerant 313
- Refrigerant filling capacity 313
- Setting the air distribution 116
- Setting the air vents 120
- Setting the airflow 117
- Setting the climate mode 116
- Setting the temperature 116
- Setting the temperature with 3-zone automatic climate control 116
- Setting the temperature with dual-zone automatic climate control 116
- Switching air-recirculation mode on/off 119
- Switching on/off 114
- Switching residual heat on/off 119
- Switching the rear window defroster on/off 118
- Switching the ZONE function on/off 117
- Cockpit**
- Overview 32
- see Instrument cluster
- COLLISION PREVENTION ASSIST PLUS**
- Activating/deactivating 192
- Display message 200
- Operation/notes 65
- COMAND**
- Switching on/off 230
- COMAND display**
- Cleaning 263
- Combination switch** 104
- Connecting a USB device**
- see also Digital Operator's Manual 229
- Consumption statistics (on-board computer)** 187
- Controller** 230
- Convenience closing feature** 84
- Convenience opening feature** 83
- Coolant (engine)**
- Checking the level 256
- Display message 207
- Filling capacity 312
- Important safety notes 312
- Temperature gauge 184
- Warning lamp 225
- Cooling**
- see Climate control
- Copyright** 31
- Cornering light function**
- Display message 206
- Function/notes 105
- Cruise control**
- Activation conditions 145
- Cruise control lever 145
- Deactivating 146
- Display message 213
- Driving system 145
- Function/notes 145
- Important safety notes 145
- Setting a speed 146
- Storing and maintaining current speed 145

- Cup holder**
 - Center console 240
 - Important safety notes 240
 - Rear compartment 240
 - Customer Assistance Center (CAC)** 28
 - Customer Relations Department** 28
- D**
- Dashboard**
 - see Instrument cluster
 - Data**
 - see Technical data
 - Data carrier**
 - Selecting 189
 - Daytime running lamps**
 - Display message 206
 - Function/notes 103
 - Switching on/off (on-board computer) 194
 - Declarations of conformity** 27
 - Delayed switch-off**
 - Exterior lighting (on-board computer) 194
 - Interior lighting 195
 - Diagnostics connection** 28
 - Digital Operator's Manual**
 - Help 22
 - Introduction 22
 - Digital speedometer** 187
 - DIRECT SELECT lever**
 - Automatic transmission 128
 - Display messages**
 - ASSYST PLUS 257
 - Calling up (on-board computer) 197
 - Driving systems 209
 - Engine 207
 - General notes 197
 - Hiding (on-board computer) 197
 - KEYLESS-GO 218
 - Lights 206
 - Safety systems 198
 - SmartKey 218
 - Tires 214
 - Vehicle 215
 - Distance recorder** 186
 - Distance warning (warning lamp)** 227
 - Distance warning function**
 - Function/notes 65
 - DISTRONIC PLUS**
 - Activating 149
 - Activation conditions 149
 - Deactivating 152
 - Display message 211
 - Displays in the multifunction display 152
 - Function/notes 147
 - Important safety notes 147
 - Setting the specified minimum distance 151
 - Stopping 150
 - Doors**
 - Automatic locking (on-board computer) 195
 - Automatic locking (switch) 79
 - Central locking/unlocking (SmartKey) 73
 - Control panel 39
 - Display message 217
 - Emergency locking 80
 - Emergency unlocking 80
 - Important safety notes 78
 - Opening (from inside) 78
 - Drinking and driving** 141
 - Drive program**
 - Automatic 132
 - Display (DIRECT SELECT lever) 128
 - Manual 132
 - Manual (vehicles with Sports package AMG) 133
 - Driver's door**
 - see Doors
 - Driving abroad**
 - Mercedes-Benz Service 258
 - Driving on flooded roads** 144
 - Driving safety systems**
 - ABS (Anti-lock Braking System) 62
 - ADAPTIVE BRAKE 69
 - Adaptive Brake Assist 66
 - BAS (Brake Assist System) 63
 - BAS PLUS with Cross-Traffic Assist 63
 - COLLISION PREVENTION ASSIST PLUS 65
 - Distance warning function 65

- EBD (electronic brake force distribution) 69
- ESP® (Electronic Stability Program) 67
- Important safety information 62
- Overview 62
- PRE-SAFE® Brake 69
- STEER CONTROL 71
- Driving systems**
- 360° camera 169
- Active Blind Spot Assist 178
- Active Driving Assistance package 178
- Active Lane Keeping Assist 181
- Active Parking Assist 161
- ATTENTION ASSIST 172
- Blind Spot Assist 175
- Cruise control 145
- Display message 209
- DISTRONIC PLUS 147
- DISTRONIC PLUS with Steering Assist and Stop&Go Pilot 154
- Dynamic handling package with sports mode 157
- HOLD function 156
- Lane Keeping Assist 177
- Lane Tracking package 175
- PARKTRONIC 158
- Rear view camera 165
- Traffic Sign Assist 174
- Driving tips**
- Automatic transmission 130
- Brakes 142
- Break-in period 121
- Downhill gradient 142
- Drinking and driving 141
- Driving in winter 144
- Driving on flooded roads 144
- Driving on wet roads 143
- Exhaust check 141
- Fuel 140
- General 140
- Hydroplaning 143
- Icy road surfaces 144
- Limited braking efficiency on salted roads 143
- Snow chains 283
- Wet road surface 142
- DVD video**
- Operating (on-board computer) 189
- see also Digital Operator's Manual 229
- Dynamic handling package with sports mode** 157
- E**
- E10**
- see Fuel
- EASY-ENTRY feature**
- Activating/deactivating 195
- Function/notes 98
- EASY-EXIT feature**
- Crash-responsive 99
- Function/notes 98
- Switching on/off 195
- EBD (electronic brake force distribution)**
- Display message 199
- Function/notes 69
- ECO display**
- Function/notes 141
- On-board computer 187
- ECO start/stop function**
- Automatic engine start 125
- Automatic engine switch-off 125
- Deactivating/activating 126
- General information 125
- Important safety notes 125
- Introduction 125
- Electronic Stability Program**
- see ESP® (Electronic Stability Program)
- Emergency**
- Automatic measures after an accident 56
- Emergency release**
- Driver's door 80
- Trunk 82
- Vehicle 80
- Emergency spare wheel**
- General notes 304
- Important safety notes 304
- Removing 305
- Storage location 305
- Stowing 305
- Technical data 304

- Emergency Tensioning Devices**
 - Activation 52
 - Emissions control**
 - Service and warranty information 25
 - Engine**
 - Check Engine warning lamp 225
 - Display message 207
 - ECO start/stop function 125
 - Engine number 308
 - Irregular running 127
 - Jump-starting 274
 - Starting problems 127
 - Starting the engine with the SmartKey 124
 - Starting with KEYLESS-GO 124
 - Switching off 139
 - Tow-starting (vehicle) 278
 - Engine electronics**
 - Problem (malfunction) 127
 - Engine jump starting**
 - see Jump starting (engine)
 - Engine oil**
 - Adding 256
 - Additives 311
 - Checking the oil level 255
 - Checking the oil level using the dipstick 255
 - Display message 208
 - Filling capacity 311
 - Notes about oil grades 311
 - Notes on oil level/consumption 255
 - Entering an address**
 - see also Digital Operator's Manual 229
 - ESP® (Electronic Stability Program)**
 - Characteristics 68
 - Deactivating/activating 191
 - Deactivating/activating (notes) 68
 - Display message 198
 - Function/notes 67
 - General notes 67
 - Important safety information 67
 - Trailer stabilization 69
 - Warning lamp 222
 - ETS/4ETS (Electronic Traction System)** 67
 - Exhaust check** 141
 - Exhaust pipe (cleaning instructions)** 263
 - Exterior lighting**
 - Setting options 103
 - see Lights
 - Exterior mirrors**
 - Adjusting 99
 - Dipping (automatic) 100
 - Folding in when locking (on-board computer) 196
 - Folding in/out (automatically) 100
 - Folding in/out (electrically) 100
 - Out of position (troubleshooting) ... 100
 - Setting 100
 - Storing settings (memory function) 102
 - Storing the parking position 101
- F**
- Favorites**
 - Overview 231
 - Filler cap**
 - see Refueling
 - Flat tire**
 - MOExtended tires 266
 - Preparing the vehicle 266
 - TIREFIT kit 267
 - see Emergency spare wheel
 - Floormats** 253
 - Frequencies**
 - Mobile phone 306
 - Two-way radio 306
 - Fuel**
 - Consumption statistics 187
 - Displaying the current consumption 187
 - Displaying the range 187
 - Driving tips 140
 - Flexible fuel vehicles 310
 - Fuel gauge 33
 - Grade (gasoline) 309
 - Important safety notes 309
 - Problem (malfunction) 138
 - Refueling 135
 - Tank content/reserve fuel 309

- Fuel filler flap**
Opening 136
- Fuel level**
Calling up the range (on-board computer) 187
- Fuel tank**
Capacity 309
Problem (malfunction) 138
- Fuse allocation chart (vehicle tool kit)** 266
- Fuses**
Allocation chart 279
Before changing 279
Dashboard fuse box 279
Fuse box in the engine compartment 280
Fuse box in the trunk 280
Important safety notes 279
- G**
- Garage door opener**
Clearing the memory 253
General notes 250
Important safety notes 250
Opening/closing the garage door .. 252
Problems when programming 252
Programming (button in the rear-view mirror) 250
Synchronizing the rolling code 251
- Gasoline** 309
- Genuine parts** 24
- Glove box** 236
- Google™ Local Search**
see also Digital Operator's Manual 229
- H**
- Handbrake**
see Parking brake
- Hazard warning lamps** 105
- Head bags**
Display message 203
- Head restraints**
Adjusting 93
Adjusting (electrically) 93
see NECK-PRO head restraints
- Headlamps**
Fogging up 106
see Automatic headlamp mode
- Heating**
see Climate control
- High beam flasher** 104
- High-beam headlamps**
Adaptive Highbeam Assist 105
Changing bulbs 108
Display message 206
Switching on/off 104
- Hill start assist** 124
- HOLD function**
Activating 156
Deactivating 156
Display message 209
Function/notes 156
- Home address**
see also Digital Operator's Manual 229
- Hood**
Closing 255
Display message 217
Important safety notes 254
Opening 254
- Horn** 32
- Hydroplaning** 143
- I**
- Ignition lock**
see Key positions
- Immobilizer** 72
- Indicator and warning lamps**
COLLISION PREVENTION ASSIST PLUS 227
- Indicator lamps**
see Warning and indicator lamps
- Indicators**
see Turn signals
- Instrument cluster**
Overview 33
Settings 193
Warning and indicator lamps 33
- Instrument cluster lighting** 194
- Interior lighting**
Automatic control 107

- Delayed switch-off (on-board computer) 195
 Overview 107
 Reading lamp 107
 Setting the brightness of the display/switch (on-board computer) .. 194
- iPod®**
 see also Digital Operator's Manual 229
- J**
- Jack**
 Storage location 266
 Using 301
- Jump starting (engine)** 274
- K**
- Key positions**
 KEYLESS-GO 122
 SmartKey 122
- KEYLESS-GO**
 Convenience closing feature 84
 Deactivation 73
 Display message 218
 Locking 73
 Removing the Start/Stop button ... 123
 Start/Stop button 122
 Starting the engine 124
 Unlocking 73
- Kickdown**
 Driving tips 131
 Manual drive program 134
- Knee bag** 47
- L**
- Lamps**
 see Warning and indicator lamps
- Lane Keeping Assist**
 Activating/deactivating 193
 Display message 210
 Function/information 177
- Lane Tracking package** 175
- LATCH-type (ISOFIX) child seat anchors** 59
- License plate lamp (display message)** 206
- Light function, active**
 Display message 206
- Light sensor (display message)** 206
- Lights**
 Activating/deactivating the interior lighting delayed switch-off 195
 Adaptive Highbeam Assist 105
 Automatic headlamp mode 103
 Cornering light function 105
 Hazard warning lamps 105
 High beam flasher 104
 High-beam headlamps 104
 Light switch 103
 Low-beam headlamps 104
 Parking lamps 104
 Rear fog lamp 104
 Setting the brightness of the display/switch (on-board computer) .. 194
 Standing lamps 104
 Switching the daytime running lamps on/off (on-board computer) 194
 Switching the exterior lighting delayed switch-off on/off (on-board computer) 194
 Switching the surround lighting on/off (on-board computer) 194
 Turn signals 104
 see Interior lighting
 see Replacing bulbs
- Loading guidelines** 235
- Locking**
 see Central locking
- Locking (doors)**
 Automatic 79
 Emergency locking 80
 From inside (central locking button) 79
- Locking centrally**
 see Central locking
- Locking verification signal (on-board computer)** 195
- Low-beam headlamps**
 Display message 206
 Switching on/off 104
- Lumbar support**
 Adjusting the 4-way lumbar support 94

- M**
- M+S tires** 283
 - Malfunction message**
 - see Display messages
 - Matte finish (cleaning instructions)** 261
 - mbrace**
 - Call priority 246
 - Display message 200
 - Downloading destinations (COMAND) 246
 - Downloading routes 249
 - Emergency call 244
 - General notes 243
 - Geo fencing 250
 - Locating a stolen vehicle 248
 - MB info call button 246
 - Remote fault diagnosis 248
 - Remote vehicle locking 248
 - Roadside Assistance button 245
 - Search & Send 247
 - Self-test 243
 - Speed alert 249
 - System 243
 - Triggering the vehicle alarm 250
 - Vehicle remote unlocking 248
 - Mechanical key**
 - Function/notes 75
 - General notes 75
 - Inserting 75
 - Locking vehicle 80
 - Removing 75
 - Unlocking the driver's door 80
 - Media Interface**
 - USB port in the armrest of the center console 236
 - see Separate operating instructions
 - Memory card (audio)** 189
 - Memory function** 102
 - Mercedes-Benz Intelligent Drive**
 - 360° camera 169
 - Active Blind Spot Assist 178
 - Active Lane Keeping Assist 181
 - Active Parking Assist 161
 - ATTENTION ASSIST 172
 - Blind Spot Assist 175
 - Cruise control 145
 - DISTRONIC PLUS 147
 - DISTRONIC PLUS with Steering Assist and Stop&Go Pilot 154
 - General notes 144
 - Lane Keeping Assist 177
 - PARKTRONIC 158
 - PRE-SAFE® (anticipatory occupant protection) 55
 - PRE-SAFE® PLUS (anticipatory occupant protection PLUS) 56
 - Rear view camera 165
 - Traffic Sign Assist 174
 - Message memory (on-board computer)** 197
 - Messages**
 - see Display messages
 - Mirrors**
 - see Exterior mirrors
 - see Rear-view mirror
 - see Vanity mirror (in the sun visor)
 - Mobile phone**
 - Connecting (Bluetooth® interface) 232
 - Connecting another mobile phone 234
 - Frequencies 306
 - Installation 306
 - Menu (on-board computer) 190
 - Transmission output (maximum) 306
 - Modifying the programming (SmartKey)** 74
 - MOExtended tires** 266
 - Mounting wheels**
 - Lowering the vehicle 303
 - Mounting a new wheel 302
 - Preparing the vehicle 300
 - Raising the vehicle 301
 - Removing a wheel 302
 - Securing the vehicle against rolling away 300
 - MP3**
 - Operation 189
 - see also Digital Operator's Manual 229
 - Multicontour seat**
 - Adjusting (on the seat) 94

- Multifunction display**
 Function/notes 186
 Permanent display 193
- Multifunction steering wheel**
 Operating the on-board computer .. 185
 Overview 34
- Multimedia system**
 see Separate operating instructions
- Music files**
 see also Digital Operator's Manual 229
- N**
- Navigation**
 Menu (on-board computer) 188
 see also Digital Operator's Manual 229
- NECK-PRO head restraints**
 Important safety notes 54
 Operation 54
 Resetting triggered 55
- Notes on breaking-in a new vehicle** 121
- O**
- Occupant Classification System (OCS)**
 Conditions 49
 Faults 52
 Operation 49
 System self-test 51
- Occupant safety**
 Air bags 45
 Automatic measures after an accident 56
 Children in the vehicle 56
 Important safety notes 40
 Introduction to the restraint system 40
 Occupant Classification System (OCS) 48
 PASSENGER AIR BAG indicator lamps 41
 Pets in the vehicle 62
 PRE-SAFE® (anticipatory occupant protection) 55
 PRE-SAFE® PLUS (anticipatory occupant protection PLUS) 56
 Restraint system warning lamp 40
- OCS**
 Conditions 49
 Faults 52
 Operation 49
 System self-test 51
- Odometer** 186
- Oil**
 see Engine oil
- On-board computer**
 Assistance menu 191
 Audio menu 189
 Convenience submenu 195
 Display messages 197
 Displaying a service message 258
 DISTRONIC PLUS 152
 Factory settings submenu 196
 Important safety notes 184
 Instrument cluster submenu 193
 Lighting submenu 194
 Menu overview 186
 Message memory 197
 Navigation menu 188
 Operation 185
 Service menu 193
 Settings menu 193
 Standard display 186
 Telephone menu 190
 Trip menu 186
 Vehicle submenu 195
 Video DVD operation 189
- Operating safety**
 Declaration of conformity 27
 Important safety notes 27
- Operating system**
 see On-board computer
- Operation**
 Digital Operator's Manual 22
- Operator's Manual**
 Vehicle equipment 25
- Outside temperature display** 184
- Overhead control panel** 38
- Override feature**
 Rear side windows 61

- P**
- Paint code number** 307
- Paintwork (cleaning instructions)** ... 260
- Panic alarm** 40
- Panorama roof with power tilt/
sliding panel**
- Important safety notes 86
 - Operating 87
 - Operating the roller sunblinds for
the sliding sunroof 87
 - Problem (malfunction) 90
 - Reversing feature 87
- Parking**
- Important safety notes 138
 - Parking brake 139
 - Position of exterior mirror, front-
passenger side 101
 - Rear view camera 165
 - see PARKTRONIC
- Parking aid**
- Active Parking Assist 161
 - see Exterior mirrors
 - see PARKTRONIC
- Parking assistance**
see PARKTRONIC
- Parking brake**
- Display message 199
 - Notes/function 139
 - Warning lamp 221
- Parking lamps**
- Switching on/off 104
- PARKTRONIC**
- Deactivating/activating 160
 - Driving system 158
 - Function/notes 158
 - Important safety notes 158
 - Problem (malfunction) 161
 - Range of the sensors 158
 - Warning display 159
- PASSENGER AIR BAG**
- Display message 204
- PASSENGER AIR BAG OFF**
- Indicator lamp 41
 - Problems (malfunctions) 204
- Pets in the vehicle** 62
- Phone book**
see also Digital Operator's Man-
ual 229
- Plastic trim (cleaning instruc-
tions)** 263
- Power washers** 260
- Power windows**
see Side windows
- PRE-SAFE® (anticipatory occupant
protection)**
- Display message 200
 - Operation 55
- PRE-SAFE® Brake**
- Activating/deactivating 192
 - Display message 201
 - Function/notes 69
 - Important safety notes 70
 - Warning lamp 227
- PRE-SAFE® PLUS (anticipatory
occupant protection PLUS)**
- Display message 201
 - Operation 56
- Program selector button** 131
- Protection against theft**
- ATA (Anti-Theft Alarm system) 72
 - Immobilizer 72
- Protection of the environment**
- General notes 24
- Pulling away**
- Automatic transmission 124
 - General notes 124
- Q**
- QR code**
- Mercedes-Benz Guide App 1
 - Rescue card 29
- Qualified specialist workshop** 28
- R**
- Radio**
- Selecting a station 189
 - see separate operating instructions
- Radio mode**
see also Digital Operator's Man-
ual 229

- Radio-wave reception/transmission in the vehicle**
 Declaration of conformity 27
- Reading lamp** 107
- Rear compartment**
 Setting the temperature 116
- Rear fog lamp**
 Display message 206
 Switching on/off 104
- Rear seats**
 Display message 217
- Rear view camera**
 Cleaning instructions 262
 Display in the multimedia system .. 166
 Function/notes 165
 Switching on/off 166
- Rear window blind** 241
- Rear window defroster**
 Problem (malfunction) 119
 Switching on/off 118
- Rear-view mirror**
 Anti-glare (manual) 99
 Dipping (automatic) 100
- Refrigerant (air-conditioning system)**
 Important safety notes 313
- Refueling**
 Fuel gauge 33
 Important safety notes 135
 Refueling process 136
 see Fuel
- Remote control**
 Garage door opener 250
 Programming (garage door opener) 250
- Replacing bulbs**
 Important safety notes 107
 Overview of bulb types 108
- Reporting safety defects** 28
- Rescue card** 29
- Reserve (fuel tank)**
 see Fuel
- Reserve fuel**
 Display message 208
 Warning lamp 225
 see Fuel
- Residual heat (climate control)** 119
- Restraint system**
 Display message 202
 Introduction 40
 Problem (malfunction) 224
 Warning lamp (function) 40
- Reversing feature**
 Panorama sliding sunroof 87
 Roller sunblinds 88
 Side windows 82
 Sliding sunroof 87
- Reversing lamps (display message)** 206
- Roadside Assistance (breakdown)** 26
- Roller sunblind**
 Panorama roof with power tilt/sliding panel 87
 Rear window 241
- Roof lining and carpets (cleaning guidelines)** 265
- Roof load (maximum)** 313
- Route guidance**
 see also Digital Operator's Manual 229

S

Safety

- Children in the vehicle 56
 see Occupant safety

Safety system

- see Driving safety systems

SD memory card

- Ejecting 234
 Inserting 234
 Inserting/removing 234
 see also Digital Operator's Manual 229
 Selecting 189

Search & Send

- see also Digital Operator's Manual 229

Seat belts

- Adjusting the driver's and front-passenger seat belt 45
 Automatic comfort-fit feature 44
 Cleaning 264
 Correct usage 43
 Fastening 43

- Important safety guidelines 42
- Introduction 41
- Releasing 44
- Switching belt adjustment on/off
(on-board computer) 196
- Warning lamp 220
- Warning lamp (function) 45
- Seats**
 - Adjusting (electrically) 92
 - Adjusting the 4-way lumbar support 94
 - Adjusting the head restraint 93
 - Adjusting the multicontour seat 94
 - Cleaning the cover 264
 - Correct driver's seat position 91
 - Folding the backrests forward/
back 93
 - Important safety notes 91
 - Overview 91
 - Seat backrest display message 217
 - Seat heating 95
 - Seat heating problem 96
 - Storing settings (memory function) 102
 - Switching seat heating on/off 95
 - Switching seat ventilation on/
off 95
- Section**
 - Trunk 80
- Securing cargo** 238
- Selector lever**
 - Cleaning 263
- Sensors (cleaning instructions)** 262
- Service menu (on-board computer)** 193
- Service message**
 - see ASSYST PLUS
- Service products**
 - Brake fluid 311
 - Coolant (engine) 312
 - Engine oil 311
 - Fuel 309
 - Important safety notes 308
 - Refrigerant (air-conditioning system) 313
 - Washer fluid 312
- Setting the air distribution** 116
- Setting the airflow** 117
- Setting the date/time format**
 - see also Digital Operator's Manual 229
- Setting the language**
 - see also Digital Operator's Manual 229
- Setting the time**
 - see also Digital Operator's Manual 229
- Settings**
 - Factory (on-board computer) 196
 - On-board computer 193
- Side impact air bag** 47
- Side marker lamp (display message)** 206
- Side windows**
 - Cleaning 261
 - Convenience closing feature 84
 - Convenience opening feature 83
 - Important safety information 82
 - Opening/closing 83
 - Problem (malfunction) 86
 - Resetting 85
 - Reversing feature 82
- SIRIUS services**
 - see also Digital Operator's Manual 229
- Sliding sunroof**
 - see Panorama roof with power tilt/sliding panel
- SmartKey**
 - Changing the battery 76
 - Changing the programming 74
 - Checking the battery 76
 - Convenience closing feature 84
 - Convenience opening feature 83
 - Display message 218
 - Door central locking/unlocking 73
 - Important safety notes 73
 - Loss 77
 - Mechanical key 75
 - Overview 73
 - Positions (ignition lock) 122
 - Problem (malfunction) 77
 - Starting the engine 124

- SMS**
 see also Digital Operator's Manual 229
 snow 283
- Sockets**
 General notes 243
 Rear compartment 243
- Sound**
 Switching on/off 230
- Special seat belt retractor** 57
- Specialist workshop** 28
- Speed, controlling**
 see Cruise control
- Speedometer**
 Digital 187
 In the Instrument cluster 33
 Segments 184
 Selecting the display unit 193
- Standing lamps**
 Display message 206
 Switching on/off 104
- Start/stop function**
 see ECO start/stop function
- Starting (engine)** 123
- STEER CONTROL** 71
- Steering**
 Display message 218
- Steering Assist and Stop&Go Pilot (DISTRONIC PLUS)**
 Activating/deactivating 192
 Display message 213
- Steering assistant STEER CONTROL**
 see STEER CONTROL
- Steering wheel**
 Adjusting (electrically) 96
 Button overview 34
 Buttons (on-board computer) 185
 Cleaning 263
 Important safety notes 96
 Paddle shifters 132
 Steering wheel heating 96
 Storing settings (memory function) 102
- Steering wheel heating**
 Problem (malfunction) 98
 Switching on/off 96
- Steering wheel paddle shifters** 132
- Stowage areas** 235
- Stowage compartments**
 Armrest (under) 236
 Center console 236
 Cup holders 240
 Glove box 236
 Important safety information 235
 Stowage net 237
 Under driver's seat/front-passenger seat 236
- Stowage net** 237
- Stowage well beneath the trunk floor** 239
- Summer tires** 283
- Sun visor** 240
- Surround lighting (on-board computer)** 194
- Switching air-recirculation mode on/off** 119
- Switching on media mode**
 Via the device list 234

T

- Tachometer** 184
- Tail lamps**
 Display message 206
- Tank**
 see Fuel tank
- Tank content**
 Fuel gauge 33
- Technical data**
 Capacities 308
 Emergency spare wheel 304
 Information 306
 Tires/wheels 303
 Vehicle data 313
- Telephone**
 Accepting a call (multifunction steering wheel) 190
 Authorizing a mobile phone (connecting) 233
 Connecting a mobile phone (general information) 232
 Display message 217
 Menu (on-board computer) 190
 Number from the phone book 190

- Redialing 191
- Rejecting/ending a call 190
- see also Digital Operator's Manual 229
- Switching between mobile phones 234
- Temperature**
- Coolant 184
- Outside temperature 184
- Setting (climate control) 116
- Tire pressure**
- Calling up (on-board computer) 287
- Checking manually 287
- Display message 214
- Maximum 287
- Not reached (TIREFIT) 269
- Notes 286
- Reached (TIREFIT) 269
- Recommended 284
- Tire pressure monitor**
- Checking the tire pressure electronically 289
- Function/notes 287
- General notes 287
- Important safety notes 288
- Restarting 289
- Warning lamp 228
- Warning message 289
- Tire-change tool kit** 266
- TIREFIT kit** 267
- Important safety notes 267
- Tire pressure not reached 269
- Tire pressure reached 269
- Tires**
- Aspect ratio (definition) 298
- Average weight of the vehicle occupants (definition) 297
- Bar (definition) 297
- Changing a wheel 299
- Characteristics 297
- Checking 281
- Curb weight (definition) 298
- Definition of terms 297
- Direction of rotation 300
- Display message 214
- Distribution of the vehicle occupants (definition) 299
- DOT (Department of Transportation) (definition) 297
- DOT, Tire Identification Number (TIN) 297
- GAWR (Gross Axle Weight Rating) (definition) 298
- GVW (Gross Vehicle Weight) (definition) 298
- GVWR (Gross Vehicle Weight Rating) (definition) 298
- Important safety notes 281
- Increased vehicle weight due to optional equipment (definition) 298
- Information on driving 281
- Kilopascal (kPa) (definition) 298
- Labeling (overview) 294
- Load bearing index (definition) 299
- Load index 296
- Load index (definition) 298
- Maximum load on a tire (definition) 298
- Maximum loaded vehicle weight (definition) 298
- Maximum permissible tire pressure (definition) 298
- Maximum tire load 296
- Maximum tire load (definition) 298
- MOExtended tires 283
- Optional equipment weight (definition) 299
- PSI (pounds per square inch) (definition) 298
- Replacing 299
- Service life 282
- Sidewall (definition) 299
- Speed rating (definition) 298
- Storing 300
- Structure and characteristics (definition) 297
- Temperature 294
- TIN (Tire Identification Number) (definition) 299
- Tire bead (definition) 299
- Tire pressure (definition) 299
- Tire pressures (recommended) 298
- Tire size (data) 303
- Tire size designation, load-bearing capacity, speed rating 294

- Tire tread 282
 - Tire tread (definition) 299
 - Total load limit (definition) 299
 - Traction 293
 - Traction (definition) 299
 - Tread wear 293
 - Uniform Tire Quality Grading Standards 293
 - Uniform Tire Quality Grading Standards (definition) 297
 - Wear indicator (definition) 299
 - Wheel and tire combination 303
 - Wheel rim (definition) 298
 - see Flat tire
 - Top Tether** 59
 - Tow-starting**
 - Emergency engine starting 278
 - Important safety notes 276
 - Towing a trailer**
 - ESP® (Electronic Stability Program) 69
 - Towing away**
 - Important safety guidelines 276
 - Installing the towing eye 277
 - Removing the towing eye 277
 - Transporting the vehicle 278
 - With both axles on the ground 277
 - With the rear axle raised 278
 - Towing eye** 266
 - Traffic reports**
 - see also Digital Operator's Manual 229
 - Traffic Sign Assist**
 - Display message 209
 - Function/notes 174
 - Important safety notes 174
 - Instrument cluster display 174
 - Transfer case** 135
 - Transmission**
 - see Automatic transmission
 - Transmission position display** 128
 - Transmission position display (DIRECT SELECT lever)** 128
 - Transporting the vehicle** 278
 - Trim pieces (cleaning instructions)** 264
 - Trip computer (on-board computer)** 187
 - Trip odometer**
 - Calling up 186
 - Resetting (on-board computer) 187
 - Trunk**
 - Emergency release 81
 - Important safety notes 80
 - Locking separately 81
 - Opening (automatically from inside) 81
 - Opening/closing (manually from outside) 80
 - Trunk lid**
 - Display message 217
 - Opening dimensions 313
 - Trunk load (maximum)** 313
 - Turn signals**
 - Display message 206
 - Switching on/off 104
 - Two-way radio**
 - Frequencies 306
 - Installation 306
 - Transmission output (maximum) 306
 - Type identification plate**
 - see Vehicle identification plate
- ## U
- Unlocking**
 - Emergency unlocking 80
 - From inside the vehicle (central unlocking button) 79
 - USB devices**
 - Connecting to the Media Interface 234
- ## V
- Vanity mirror (in the sun visor)** 241
 - Vehicle**
 - Correct use 28
 - Data acquisition 29
 - Display message 215
 - Equipment 25
 - Individual settings 193
 - Limited Warranty 29
 - Loading 290

- Locking (in an emergency) 80
 - Locking (SmartKey) 73
 - Lowering 303
 - Maintenance 26
 - Parking for a long period 140
 - Pulling away 124
 - Raising 301
 - Reporting problems 28
 - Securing from rolling away 300
 - Towing away 276
 - Transporting 278
 - Unlocking (in an emergency) 80
 - Unlocking (SmartKey) 73
 - Vehicle data 313
 - Vehicle data** 313
 - Vehicle dimensions** 313
 - Vehicle emergency locking** 80
 - Vehicle identification number**
see VIN
 - Vehicle identification plate** 307
 - Vehicle tool kit** 266
 - Video**
Operating the DVD 189
see also Digital Operator's Manual 229
 - VIN**
Seat 308
Type plate 307
 - Voice Control System**
see Separate operating instructions
- W
- Warning and indicator lamps**
ABS 222
Brakes 221
Check Engine 225
Coolant 225
Distance warning 227
ESP® 222
ESP® OFF 223
Fuel tank 225
General notes 219
Overview 33
PASSENGER AIR BAG OFF 41
Reserve fuel 225
Restraint system 224
Seat belt 220
 - Tire pressure monitor 228
 - Warranty** 25
 - Washer fluid**
Display message 218
 - Wheel and tire combinations**
Tires 303
 - Wheel bolt tightening torque** 303
 - Wheel chock** 300
 - Wheels**
Changing a wheel 299
Checking 281
Cleaning 261
Emergency spare wheel 304
Important safety notes 281
Information on driving 281
Interchanging/changing 299
Mounting a new wheel 302
Mounting a wheel 300
Removing a wheel 302
Storing 300
Tightening torque 303
Wheel size/tire size 303
 - Window curtain air bag**
Operation 48
 - Windows**
see Side windows
 - Windshield**
Defrosting 117
 - Windshield washer fluid**
see Windshield washer system
 - Windshield washer system**
Adding washer fluid 257
Important safety notes 312
 - Windshield wipers**
Problem (malfunction) 110
Replacing the wiper blades 109
Switching on/off 108
 - Winter driving**
Important safety notes 283
Slippery road surfaces 144
Snow chains 283
 - Winter tires**
M+S tires 283
 - Wiper blades**
Cleaning 261
Important safety notes 109
Replacing 109

Wooden trim (cleaning instructions) 264

Workshop

see Qualified specialist workshop

Z

ZONE function

Switching on/off 117

Introduction

The printed Operator's Manual provides information about the safe operation of your vehicle. The Digital Operator's Manual additionally describes further functions and equipment installed in your vehicle. The functions of the vehicle and multimedia system are described in the Digital Operator's Manual. You can call up the Digital Operator's Manual via the multimedia system.

- i** You will not incur any costs when calling up the Digital Operator's Manual. The Digital Operator's Manual works without connecting to the Internet.

There are three ways to access the topics of the Digital Operator's Manual:

• Visual search

The visual search allows you to explore your vehicle "virtually". Starting from either the vehicle exterior view or interior view, you can access many of the different topics covered by the Digital Operator's Manual. To access the vehicle interior section, select the "Vehicle interior" view.

• Keyword search

The keyword search allows you to search for a keyword by entering characters. Further information can be found in the Digital Operator's Manual in the "Audio 20" or "COMAND" section under the "Character entry (telephony)" keyword.





• Contents

You can select individual sections in the contents.

- i** The Digital Operator's Manual is deactivated for safety reasons while driving.

Operation

Calling up the Digital Operator's Manual

- ▶ Press the  button in the center console. The overview relating to the vehicle appears.
- ▶ Select the "Operator's Manual" menu item by turning  or pressing  the controller.
- ▶ Confirm  the message about the warning and safety notes. The basic menu for the Digital Operator's Manual appears.

Operating the Digital Operator's Manual









General notes







Please observe the information about the operation of the controller (▶ page 230).

Content pages

The content pages can be accessed by means of a visual search, a keyword search or using the contents.



- ▶ **To scroll forwards/backwards:** turn  the controller.
- ▶ **To display in full-screen or animation:** slide  the controller to the left .
- ▶ **To select information texts or save bookmarks:** slide  the controller to the right .
- ▶ **To select a link:** slide  the controller downwards .
- ▶ **To exit a content page:** select the  symbol .

- ▶ **To call up the basic menu of the Digital Operator's Manual:** select  symbol .
- ▶ **To switch functions to the multimedia system using the buttons on the center console:** press the , ,  or  button.
The selected menu appears. The Digital Operator's Manual remains open in the background.

Protection of the environment**General notes****🌱 Environmental note**

Daimler's declared policy is one of comprehensive environmental protection.

The objectives are for the natural resources that form the basis of our existence on this planet to be used sparingly and in a manner that takes the requirements of both nature and humanity into account.

You too can help to protect the environment by operating your vehicle in an environmentally responsible manner.

Fuel consumption and the rate of engine, transmission, brake and tire wear are affected by these factors:

- operating conditions of your vehicle
- your personal driving style

You can influence both factors. You should bear the following in mind:

Operating conditions:

- avoid short trips as these increase fuel consumption.
- always make sure that the tire pressures are correct.
- do not carry any unnecessary weight.
- remove roof racks once you no longer need them.
- a regularly serviced vehicle will contribute to environmental protection. You should therefore adhere to the service intervals.
- always have service work carried out at a qualified specialist workshop.

Personal driving style:

- do not depress the accelerator pedal when starting the engine.
- do not warm up the engine when the vehicle is stationary.
- drive carefully and maintain a safe distance from the vehicle in front.
- avoid frequent, sudden acceleration and braking.

- change gear in good time and use each gear only up to $\frac{2}{3}$ of its maximum engine speed.
- switch off the engine in stationary traffic.
- keep an eye on the vehicle's fuel consumption.

Environmental concerns and recommendations

Wherever the operating instructions require you to dispose of materials, first try to regenerate or re-use them. Observe the relevant environmental rules and regulations when disposing of materials. In this way you will help to protect the environment.

Genuine Mercedes-Benz parts**🌱 Environmental note**

Daimler AG also supplies reconditioned major assemblies and parts which are of the same quality as new parts. They are covered by the same Limited Warranty entitlements as new parts.

! Air bags and Emergency Tensioning Devices, as well as control units and sensors for these restraint systems, may be installed in the following areas of your vehicle:

- doors
- door pillars
- door sills
- seats
- cockpit
- instrument cluster
- center console

Do not install accessories such as audio systems in these areas. Do not carry out repairs or welding. You could impair the operating efficiency of the restraint systems.

Have aftermarket accessories installed at a qualified specialist workshop.

You could jeopardize the operating safety of your vehicle if you use parts, tires and wheels as well as accessories relevant to safety which have not been approved by Mercedes-Benz. This could lead to malfunctions in safety-relevant

systems, e.g. the brake system. Use only genuine Mercedes-Benz parts or parts of equal quality. Only use tires, wheels and accessories that have been specifically approved for your vehicle.

Genuine Mercedes-Benz parts are subject to strict quality control. Every part has been specifically developed, manufactured or selected for and adapted to Mercedes-Benz vehicles. Only genuine Mercedes-Benz parts should therefore be used.

More than 300,000 different genuine Mercedes-Benz parts are available for Mercedes-Benz models.

All authorized Mercedes-Benz Centers maintain a supply of genuine Mercedes-Benz parts for necessary service and repair work. In addition, strategically located parts delivery centers provide quick and reliable parts service.

Always specify the vehicle identification number (VIN) when ordering genuine Mercedes-Benz parts (> page 307).

Operator's Manual

Vehicle equipment

i This Operator's Manual describes all models and all standard and optional equipment of your vehicle available at the time of going to print. Country-specific differences are possible. Bear in mind that your vehicle may not feature all functions described here. This also applies to safety-relevant systems and functions. The equipment in your vehicle may therefore differ from that shown in the descriptions and illustrations.

The original purchase agreement lists all systems installed in your vehicle.

Should you have any questions concerning equipment and operation, please consult an authorized Mercedes-Benz Center.

The Operator's Manual and Maintenance Booklet are important documents and should be kept in the vehicle.

Service and vehicle operation

Warranty

The implied warranty for your vehicle applies in accordance with the warranty terms and condi-

tions in the Service and Warranty Information booklet.

Your authorized Mercedes-Benz Center will replace and repair all factory-installed parts in accordance with the following warranty terms and conditions:

- New Vehicle Limited Warranty
- Emission System Warranty
- Emission Performance Warranty
- California, Connecticut, Maine, Massachusetts, New York, Pennsylvania, Rhode Island and Vermont Emission Control System Warranty
- State warranty enforcement laws (lemon laws)

Replacement parts and accessories are covered by the Mercedes-Benz Parts and Accessories warranties. These are available at any authorized Mercedes-Benz Center.

i Should you lose your Service and Warranty Information booklet, have an authorized Mercedes-Benz Center arrange for a replacement. The new Service and Warranty Information booklet will be posted to you.

Information for customers in California

Under California law you may be entitled to a replacement of your vehicle or a refund of the purchase price or lease price, if after a reasonable number of repair attempts Mercedes-Benz USA, LLC and/or its authorized repair or service facilities fail to fix one or more substantial defects or malfunctions in the vehicle that are covered by its express warranty.

During the period of 18 months from original delivery of the vehicle or the accumulation of 18,000 miles (approximately 29,000 km) on the odometer of the vehicle, whichever occurs first, a reasonable number of repair attempts is presumed for a retail buyer or lessee if one or more of the following occurs:

- (1) the same substantial defect or malfunction results in a condition that is likely to cause death or serious bodily injury if the vehicle is driven, that defect or malfunction has been subject to repair two or more times, and you

- have directly notified Mercedes-Benz USA, LLC in writing of the need for its repair.
- (2) the same substantial defect or malfunction of a less serious nature than category (1) has been subject to repair four or more times and you have directly notified Mercedes-Benz in writing of the need for its repair.
 - (3) the vehicle is out of service by reason of repair of the same or different substantial defects or malfunctions for a cumulative total of more than 30 calendar days.

Please send your written notice to:
 Mercedes-Benz USA, LLC
 Customer Assistance Center
 One Mercedes Drive
 Montvale, NJ 07645-0350

Maintenance

The Service and Warranty Booklet describes all the necessary maintenance work which should be done at regular intervals.

Always have the Service and Warranty Booklet with you when you bring the vehicle to an authorized Mercedes-Benz Center. The service advisor will record every service for you in the Service and Warranty Booklet.

Roadside Assistance

The Mercedes-Benz Roadside Assistance Program offers technical help in the event of a breakdown. Calls to the toll-free Roadside Assistance Hotline are answered by our agents 24 hours a day, 365 days a year.

1-800-FOR-MERCEdes (1-800-367-6372) (USA)

1-800-387-0100 (Canada)

For additional information, refer to the Mercedes-Benz Roadside Assistance Program brochure (USA) or the "Roadside Assistance" section in the Service and Warranty booklet (Canada). You will find both in your vehicle literature portfolio.

Change of address or change of ownership

In the event of a change of address, please send us the "Notification of Address Change" in the Service and Guarantee booklet or simply call the Mercedes-Benz Customer Assistance Center (USA) at the hotline number 1-800-FOR-MERCEdes(1-800-367-6372) or Customer Service Center (Canada) at 1-800-387-0100. This will assist us in contacting you in a timely manner should the need arise.

If you sell your Mercedes, please leave the entire literature in the vehicle so that it is available to the next owner.

If you have purchased a used car, please send us the "Notification of Used Car Purchase" in the Service and Guarantee booklet or simply call the Mercedes-Benz Customer Assistance Center (USA) at the hotline number 1-800-FOR-MERCEdes(1-800-367-6372) or Customer Service (Canada) at 1-800-387-0100.

Vehicle operation outside the USA and Canada

If you plan to operate your vehicle in foreign countries, please be aware that:

- service facilities or replacement parts may not be readily available.
- unleaded fuel for vehicles with a catalytic converter may not be available. Leaded fuel may cause damage to the catalytic converter.
- the fuel may have a considerably lower octane rating. Unsuitable fuel can cause engine damage.

Some Mercedes-Benz models are available for delivery in Europe through our European Delivery Program. For details, consult an authorized Mercedes-Benz Center or write to one of the following addresses.

In the USA

Mercedes-Benz USA, LLC
 European Delivery Department
 One Mercedes Drive
 Montvale, NJ 07645-0350

In Canada

Mercedes-Benz Canada, Inc.
 European Delivery Department
 98 Vanderhoof Avenue
 Toronto, Ontario M4G 4C9

Operating safety

Important safety notes

WARNING

If you do not have the prescribed service/maintenance work or any required repairs carried out, this can result in malfunctions or system failures. There is a risk of an accident. Always have the prescribed service/maintenance work as well as any required repairs carried out at a qualified specialist workshop.

WARNING

Flammable material such as leaves, grass or twigs may ignite if they come into contact with hot parts of the exhaust system. There is a risk of fire.

When driving off road or on unpaved roads, check the vehicle's underside regularly. In particular, remove parts of plants or other flammable materials which have become trapped. In the case of damage, contact a qualified specialist workshop.

WARNING

Modifications to electronic components, their software as well as wiring can impair their function and/or the function of other networked components. In particular, systems relevant to safety could also be affected. As a result, these may no longer function as intended and/or jeopardize the operating safety of the vehicle. There is an increased risk of an accident and injury.

Never tamper with the wiring as well as electronic components or their software. You should have all work to electrical and electronic equipment carried out at a qualified specialist workshop.

! There is a risk of damage to the vehicle if:

- the vehicle becomes stuck, e.g. on a high curb or an unpaved road
- you drive too fast over an obstacle, e.g. a curb or a hole in the road
- a heavy object strikes the undercarriage or parts of the chassis

In situations like this, the body, the undercarriage, chassis parts, wheels or tires could be damaged without the damage being visible. Components damaged in this way can unexpectedly fall or, in the case of an accident, no longer withstand the strain they are designed to.

If the underbody paneling is damaged, combustible materials such as leaves, grass or twigs can gather between the underbody and the underbody paneling. If these materials come in contact with hot parts of the exhaust system, they can catch fire.

In such situations, have the vehicle checked and repaired immediately at a qualified specialist workshop. If on continuing your journey you notice that driving safety is impaired, pull over and stop the vehicle immediately, paying attention to road and traffic conditions. In such cases, consult a qualified specialist workshop.

Declarations of conformity

Vehicle components which receive and/or transmit radio waves

USA: "The wireless devices of this vehicle comply with Part 15 of the FCC Rules. Operation is subject to the two following two conditions: 1) These devices may not cause harmful interference, and 2) These devices must accept any interference received, including interference that may cause undesired operation. Changes or modifications not expressly approved by the party responsible for compliance could void the user's authority to operate the equipment."

Canada: "The wireless devices of this vehicle comply with Industry Canada license-exempt RSS standard(s). Operation is subject to the following two conditions: (1) These devices may not cause interference, and (2) These devices must accept any interference, including interference that may cause undesired operation of the device."

Diagnostics connection

The diagnostics connection is only intended for the connection of diagnostic equipment at a qualified specialist workshop.

WARNING

If you connect equipment to the diagnostics connection in the vehicle, it may affect the operation of the vehicle systems. As a result, the operating safety of the vehicle could be affected. There is a risk of an accident.

Do not connect any equipment to a diagnostics connection in the vehicle.

WARNING

Objects in the driver's footwell can restrict the pedal travel or obstruct a depressed pedal. The operating and road safety of the vehicle is jeopardized. There is a risk of an accident.

Make sure that all objects in the vehicle are stowed correctly, and that they cannot enter the driver's footwell. Install the floor mats securely and as specified in order to ensure sufficient clearance for the pedals. Do not use loose floor mats and do not place floor mats on top of one another.

! If the engine is switched off and equipment on the diagnostics connection is used, the starter battery may discharge.

Connecting equipment to the diagnostics connection can lead to emissions monitoring information being reset, for example. This may lead to the vehicle failing to meet the requirements of the next emissions test during the main inspection.

Qualified specialist workshop

An authorized Mercedes-Benz Center is a qualified specialist workshop. It has the necessary specialist knowledge, tools and qualifications to correctly carry out the work required on your vehicle. This is especially the case for work relevant to safety.

Observe the notes in the Maintenance Booklet.

Always have the following work carried out at an authorized Mercedes-Benz Center:

- work relevant to safety
- service and maintenance work
- repair work
- alterations, installation work and modifications
- work on electronic components

Correct use

If you remove any warning stickers, you or others could fail to recognize certain dangers.

Leave warning stickers in position.

Observe the following information when driving your vehicle:

- the safety notes in this manual
- the vehicle technical data
- traffic rules and regulations
- laws and safety standards pertaining to motor vehicles

Problems with your vehicle

If you should experience a problem with your vehicle, particularly one that you believe may affect its safe operation, we urge you to contact an authorized Mercedes-Benz Center immediately to have the problem diagnosed and rectified. If the problem is not resolved to your satisfaction, please discuss the problem again with a Mercedes-Benz Center or contact us at one of the following addresses.

In the USA

Customer Assistance Center
Mercedes-Benz USA, LLC
One Mercedes Drive
Montvale, NJ 07645-0350

In Canada

Customer Relations Department
Mercedes-Benz Canada, Inc.
98 Vanderhoof Avenue
Toronto, Ontario M4G 4C9

Reporting safety defects

USA only:

The following text is published as required of manufacturers under Title 49, Code of U.S. Federal Regulations, Part 575 pursuant to the "National Traffic and Motor Vehicle Safety Act of 1966".

If you believe that your vehicle has a defect which could cause a crash or could cause injury or death, you should immediately inform the National Highway Traffic Safety Administration (NHTSA) in addition to notifying Mercedes-Benz USA, LLC.

If NHTSA receives similar complaints, it may open an investigation, and if it finds that a safety defect exists in a group of vehicles, it may order a recall and remedy campaign. However, NHTSA cannot become involved in individual problems between you, your dealer, or Mercedes-Benz USA, LLC.

To contact NHTSA, you may call the Vehicle Safety Hotline toll-free at 1-888-327-4236 (TTY: 1-800-424-9153); go to <http://www.safercar.gov>; or write to: Administrator, NHTSA, 400 Seventh Street, SW., Washington, DC 20590.

You can also obtain other information about motor vehicle safety from

<http://www.safercar.gov>

Limited Warranty

I Follow the instructions in this manual about the proper operation of your vehicle as well as about possible vehicle damage. Damage to your vehicle that arises from culpable contraventions against these instructions is not covered either by the Mercedes-Benz Limited Warranty or by the New or Used-Vehicle Warranty.

QR codes for the rescue card

The QR codes are secured in the fuel filler flap and on the opposite side on the B-pillar. In the event of an accident, rescue services can use the QR code to quickly find the appropriate rescue card for your vehicle. The current rescue card contains the most important information about your vehicle in a compact form, e.g. the routing of the electric cables.

You can find more information under <http://portal.aftersales.i.daimler.com/public/>

content/asportal/en/communication/informationen_fuer/QRCode.html.

Data stored in the vehicle

Data storage

A wide range of electronic components in your vehicle contain data memories.

These data memories temporarily or permanently store technical information about:

- vehicle's operating state
- incidents
- malfunctions

In general, this technical information documents the state of a component, a module, a system or the surroundings.

These include, for example:

- operating conditions of system components, e.g. fluid levels
- the vehicle's status messages and those of its individual components, e.g. number of wheel revolutions/speed, deceleration in movement, lateral acceleration, accelerator pedal position
- malfunctions and defects in important system components, e.g. lights, brakes
- vehicle reactions and operating conditions in special driving situations, e.g. air bag deployment, intervention of stability control systems
- ambient conditions, e.g. outside temperature

This data is of an exclusively technical nature and can be used to:

- assist in recognizing and rectifying malfunctions and defects
- analyze vehicle functions, e.g. after an accident
- optimize vehicle function

The data cannot be used to trace the vehicle's movements.

When your vehicle is serviced, technical information can be read from the event data memory and malfunction data memory.

Services include, for example:

- repair services
- service processes
- warranties
- quality assurance

The vehicle is read out by employees of the service network (including the manufacturer) using special diagnostic testers. More detailed information is obtained from it, if required.

After a malfunction has been rectified, the information is deleted from the malfunction memory or is continually overwritten.

When operating the vehicle, situations are conceivable in which this technical data, in connection with other information (if necessary, under consultation with an authorized expert), could be traced to a person.

Examples include:

- accident reports
- damage to the vehicle
- witness statements

Further additional functions that have been contractually agreed upon with the customer allow certain vehicle data to be conveyed by the vehicle as well. The additional functions include, for example, vehicle location in case of an emergency.

COMAND/mbrace

If the vehicle is equipped with COMAND or mbrace, additional data about the vehicle's operation, the use of the vehicle in certain situations, and the location of the vehicle may be compiled through COMAND or the mbrace system.

For additional information please refer to the COMAND User Manual or the Digital Operator's Manual and/or the mbrace Terms and Conditions.

Event data recorders

This vehicle is equipped with an event data recorder (EDR). This vehicle is equipped with an event data recorder (EDR). The main purpose of an EDR is to record, in certain crash or near crash-like situations, such as an air bag deployment or hitting a road obstacle, data that will assist in understanding how a vehicle's systems performed. The EDR is designed to record data related to vehicle dynamics and safety systems for a short period of time, typically 30 seconds or less.

The EDR in this vehicle is designed to record such data as:

- How various systems in your vehicle were operating
- Whether or not the driver and passenger safety belts were buckled/fastened
- How far (if at all) the driver was depressing the accelerator and/or brake pedal and
- How fast the vehicle was traveling.

These data can help provide a better understanding of the circumstances in which accidents and injuries occur. NOTE: EDR data are recorded by your vehicle only if a non-trivial crash situation occurs; no data is recorded by the EDR under normal driving conditions and no personal data (e.g. name, gender, age and accident location) are recorded. However, other parties, such as law enforcement could combine EDR data with the type of personally identifying data routinely acquired during a crash investigation.

Access to the vehicle and/or the EDR is needed to read data that is recorded by the EDR, and special equipment is required. In addition to the vehicle manufacturer, other parties that have the special equipment, such as law enforcement, can read the information by accessing the vehicle or the EDR.

EDR data may be used in civil and criminal matters as a tool in accident reconstruction, accident claims and vehicle safety. Since the Crash Data Retrieval CDR tool that is used to extract data from the EDR is commercially available, Mercedes-Benz USA, LLC ("MBUSA") expressly disclaims any and all liability arising from the extraction of this information by unauthorized Mercedes-Benz personnel.

MBUSA will not share EDR data with others without the consent of the vehicle owners or, if the vehicle is leased, without the consent of the lessee. Exceptions to this representation include responses to subpoenas by law enforcement; by federal, state or local government; in connection with or arising out of litigation involving MBUSA or its subsidiaries and affiliates; or, as required by law.

Warning: The EDR is a component of the Restraint System Module. Tampering with, altering, modifying or removing the EDR component may result in a malfunction of the Restraint System Module and other systems.

State laws or regulations regarding EDRs that conflict with federal regulation are pre-empted.

This means that in the event of such conflict, the federal regulation governs. As of February 2013, 13 states have enacted laws relating to EDRs.

Information on copyright

General information

Information on license for free and open-source software used in your vehicle and its electronic components is available on the following website:

<http://www.mercedes-benz.com/opensource>

Cockpit

At a glance

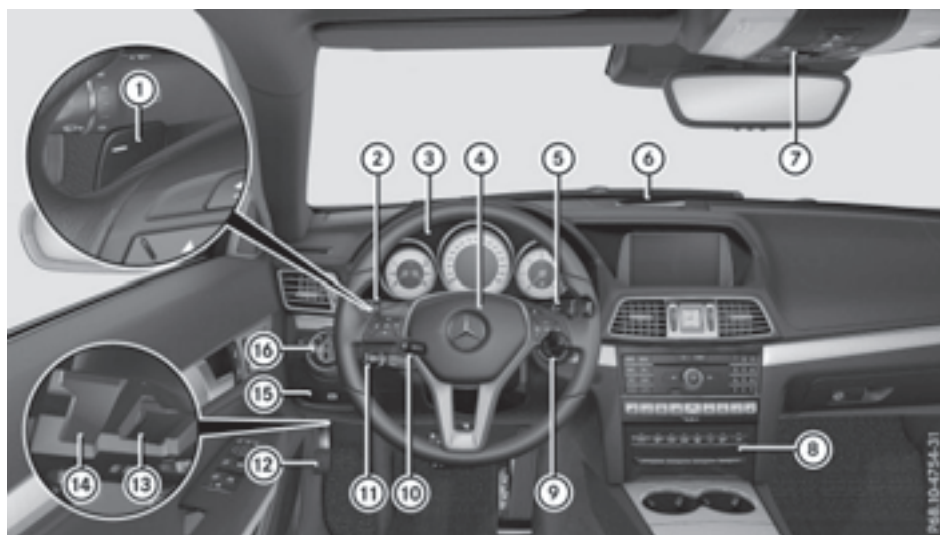

| | Function | Page |
|---|------------------------------------|------------|
| ① | Steering wheel paddle shifters | 132 |
| ② | Combination switch | 104 |
| ③ | Instrument cluster | 33 |
| ④ | Horn | |
| ⑤ | DIRECT SELECT lever | 128 |
| ⑥ | PARKTRONIC warning display | 158 |
| ⑦ | Overhead control panel | 38 |
| ⑧ | Climate control systems | 111 |
| ⑨ | Ignition lock Start/Stop button | 122 122 |

| | Function | Page |
|---|--|----------|
| ⑩ | Adjusts the steering wheel Steering wheel heating | 96 96 |
| ⑪ | Cruise control lever | 145 |
| ⑫ | Parking brake | 139 |
| ⑬ | Diagnostics connection | 28 |
| ⑭ | Opens the hood | 254 |
| ⑮ | Releases the parking brake | 139 |
| ⑯ | Light switch | 103 |

Instrument cluster

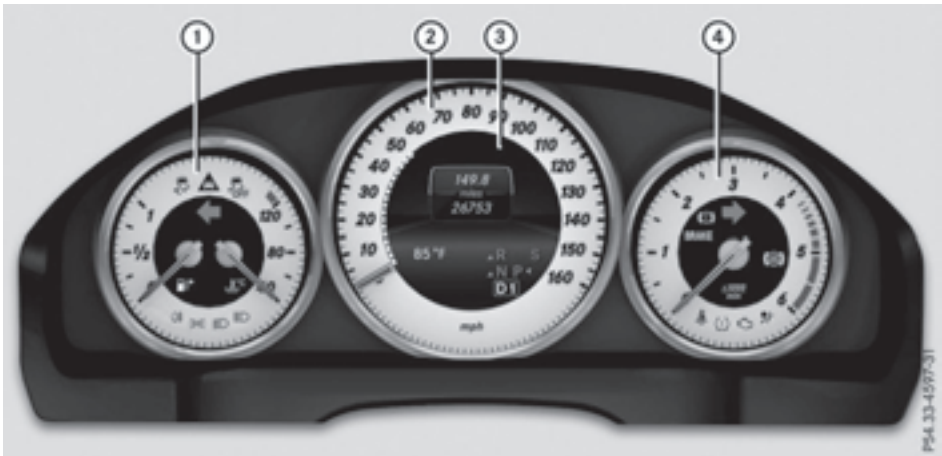







| | Function | Page | | Function | Page | | | |
|---|---|------|---|---------------------------|-----------------------|------------|------------------------------|-----|
| ① | Fuel gauge (left) | 184 | ② | Speedometer with segments | 184 | | | |
| | Coolant temperature (right) | | | ③ | Multifunction display | 186 | | |
| | Warning and indicator lamps: | | | | ④ | Tachometer | 184 | |
| | ESP® | | | | | 222 | Warning and indicator lamps: | |
| | Distance warning | | | | | 227 | Brakes (USA only) | 221 |
| | ESP® OFF | | | | | 222 | Brakes (Canada only) | 221 |
| | Turn signal, left | | | | | 104 | Turn signal, right | 104 |
| | Coolant | | | | | 225 | ABS | 222 |
| | High-beam headlamps | | | | | 104 | Restraint system | 40 |
| | Low-beam headlamps | | | | | 104 | Check Engine | 225 |
| | Parking lamps | | | | | 104 | Tire pressure monitor | 228 |
| | This lamp has no function | | | | | 104 | Seat belts | 220 |
| | Reserve fuel | | | | | 225 | | |
| | Fuel filler flap location indicator: the fuel filler cap is on the right-hand side. | | | | | | | |







Information on the display of the outside temperature in the multifunction display can be found under "Outside temperature display" (▷ page 184).

Set the lighting in the instrument cluster, in the displays and the controls in the vehicle interior using the on-board computer (▷ page 194).

Multifunction steering wheel



| | Function | Page |
|---|--|------|
| ① | Multifunction display | 186 |
| ② | Multimedia system display | |
| ③ |  Switches on voice-operated navigation or the Voice Control System | |
| ④ |  Rejects or ends a call Exits the telephone book/redial memory  Makes or accepts a call Switches to the redial memory   Adjusts the volume  Mute | 190 |

| | Function | Page |
|---|---|--------------------------|
| ⑤ |   Selects a menu   Selects a submenu or scrolls through lists  Confirms a selection Hides display messages | 185 185 185 197 |
| ⑥ |  Back Switches off voice-operated navigation or the Voice Control System | 185 |

i In vehicles with the COMAND multimedia system you can find further information:





- on the multimedia system in the Digital Operator's Manual
- on the Voice Control System in the separate operating instructions



- i** In vehicles with the Audio 20 multimedia system you can find further information:
- on the multimedia system in the Digital Operator's Manual
 - on the voice-operated control of the navigation in the manufacturer's operating instructions

Center console

Center console, upper section





| | Function | Page |
|---|---|------|
| ① | Multimedia system (see the separate operating instructions) | |
| ② |  Seat heating | 95 |
| ③ |  Seat ventilation | 95 |
| ④ |  PARKTRONIC | 158 |
| ⑤ |  ECO start/stop function | 125 |

| | Function | Page |
|---|---|------|
| ⑥ |  Hazard warning lamps | 105 |
| ⑦ |  Indicator lamp | 49 |
| ⑧ | ATA indicator lamp | 72 |
| ⑨ | Moves the seat-belt extender forwards | 43 |
| ⑩ |  Rear window roller sunblind | 241 |

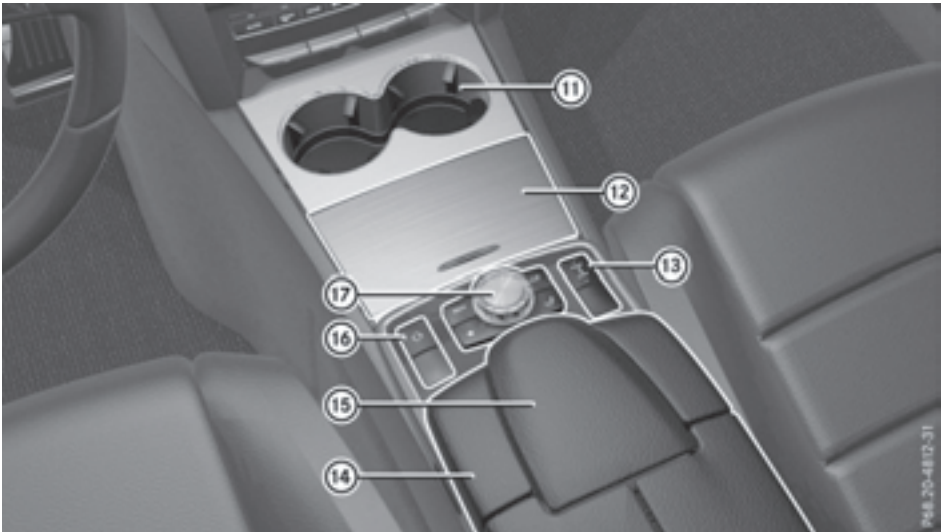
Center console, lower section



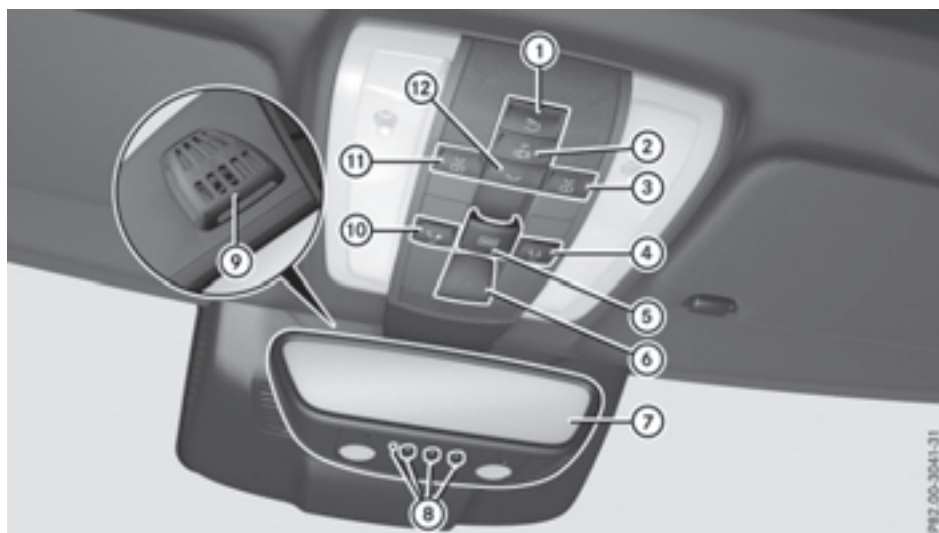

| | Function | Page | | Function | Page |
|---|---|------------|---|---|------|
| ⑪ | Cup holder | 240 | ⑮ | Stowage compartment | 235 |
| ⑫ | Stowage compartment Cup holder | 235 240 | ⑯ |  Selects the drive program | 131 |
| ⑬ |  Dynamic handling package with sports mode | 157 | ⑰ | Multimedia system controller (see the separate operating instructions) | |
| ⑭ | Stowage compartment with Media Interface | 236 | | | |

Overhead control panel



| | Function | Page |
|---|--|------|
| ① |  Switches the rear interior lighting on/off | 107 |
| ② |  Switches the automatic interior lighting control on/off | 107 |
| ③ |  Switches the right-hand reading lamp on/off | 107 |
| ④ |  Opens/closes the panorama roof with power tilt/sliding panel with roller sunblind | 87 |
| ⑤ |  MB Info call button (mbrace system) | 246 |
| ⑥ |  SOS button (mbrace system) | 244 |

| | Function | Page |
|---|---|------|
| ⑦ | Rear-view mirror | 100 |
| ⑧ | Buttons for the garage door opener | 250 |
| ⑨ | Microphone for mbrace (emergency call system), telephone and Voice Control System (see the separate operating instructions) | |
| ⑩ |  Roadside Assistance call button (mbrace system) | 245 |
| ⑪ |  Switches the left-hand reading lamp on/off | 107 |
| ⑫ |  Switches the front interior lighting on/off | 107 |

Door control panel

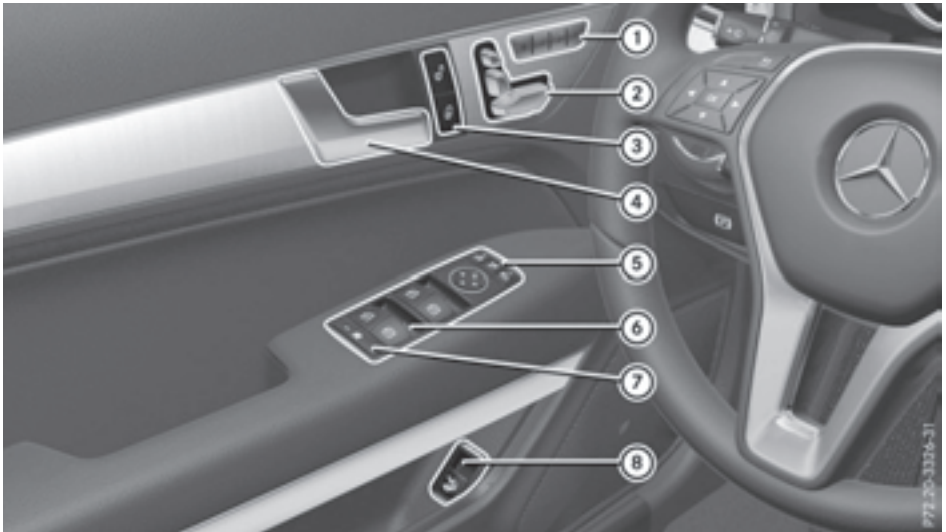

At a glance

| | Function | Page |
|---|---|------|
| ① | Stores settings for the seat, exterior mirrors and steering wheel | 102 |
| ② | Adjusts the seats electrically | 92 |
| ③ | Unlocks/locks the vehicle | 79 |
| ④ | Opens the door | 78 |
| ⑤ | Adjusts and folds the exterior mirrors in/out electrically | 99 |

| | Function | Page |
|---|---|------|
| ⑥ | Opens/closes the side windows | 83 |
| ⑦ | Activates/deactivates the override feature for the side windows in the rear compartment | 61 |
| ⑧ | Opens the trunk lid | 81 |

Panic alarm



▶ **To activate:** press the **PANIC** button ① for approximately one second.
A visual and audible alarm is triggered if the alarm system is armed.

▶ **To deactivate:** press the **PANIC** button ① again.

or

▶ Insert the SmartKey into the ignition lock.

or, on vehicles with KEYLESS-GO:

▶ Press the Start/Stop button.

The SmartKey must be in the vehicle.

Occupant safety

Introduction to the restraint system

The restraint system can reduce the risk of vehicle occupants coming into contact with parts of the vehicle's interior in the event of an accident. Furthermore, the restraint system may also reduce the forces exerted on the vehicle occupants when an accident occurs.

The restraint system includes:

- Seat belt system
- Air bags
- Child restraint system
- Child seat securing system

The components of the restraint system work in conjunction with each other. They can only offer the intended level of protection if all vehicle occupants:

- are correctly wearing their seat belts. (▷ page 43)
- adjust their seat and head restraint properly (▷ page 91).

The driver is also responsible for ensuring that the steering wheel has been correctly positioned. Observe the information relating to the correct driver's seat position (▷ page 91).

Always ensure the air bag can inflate properly if deployed (▷ page 45).

An air bag supplements a correctly fastened seat belt. As an additional safety device, the air bag increases the level of protection for vehicle occupants in the event of an accident. For example, if the protection already provided by a correctly fastened seat belt will suffice, the air bags are not deployed. Furthermore, only the air bags that would increase the degree of protection afforded to the vehicle occupants in the event of an accident are deployed. Seat belts and air bags generally do not protect against objects penetrating the vehicle from the outside.

Information on restraint system operation can be found under "Triggering of Emergency Tensioning Devices and air bags" (▷ page 52).

See "Children in the vehicle" for information on children traveling with you as well as vehicle restraint systems (▷ page 56).

Important safety notes

WARNING

Modifications to the restraint system may cause it to no longer work as intended. The restraint system may then not perform its intended protective function and may fail in an accident or trigger unexpectedly, for example. This poses an increased risk of injury or even fatal injury.

Never modify parts of the restraint system. Never tamper with the wiring, the electronic components or their software.

If it is necessary to modify an air bag system to accommodate a person with disabilities, contact an authorized Mercedes-Benz Center for details. USA only: for further information contact our Customer Assistance Center at 1-800-FOR-MERCEdes (1-800-367-6372).

Restraint system warning lamp

The functions of the restraint system are checked after the ignition is switched on and at

regular intervals while the engine is running. Therefore, malfunctions can be detected in good time.

The  restraint system warning lamp in the instrument cluster lights up when the ignition is switched on. It goes out no later than a few seconds after the vehicle is started. The components of the restraint system are in operational readiness.

A malfunction has occurred if the  restraint system warning lamp:

- does not light up after the ignition is switched on
- does not go out after a few seconds with the engine running
- lights up again while the engine is running

WARNING

If restraint system is malfunctioning, restraint system components may be triggered unintentionally or might not be triggered at all in the event of an accident with a high rate of vehicle deceleration. This can affect the Emergency Tensioning Device or air bag, for example. This poses an increased risk of injury or even fatal injury.

Have the restraint system checked and repaired in a qualified specialist workshop as soon as possible.

PASSENGER AIR BAG OFF indicator lamp



PASSENGER AIR BAG OFF indicator lamp ① is part of the Occupant Classification System (OCS).

The PASSENGER AIR BAG OFF indicator lamp informs you about the status of the front-passenger front air bag.

If the PASSENGER AIR BAG OFF indicator lamp:

- **is lit:** the front-passenger front air bag is deactivated. It will then not be deployed in the event of an accident.
- **is not lit:** the front-passenger front air bag is enabled. If, in the event of an accident, all deployment criteria are met, the front-passenger front air bag is deployed.

Depending on the person in the front-passenger seat, the front-passenger front air bag must either be deactivated or enabled; see the following points. You must make sure of this both before and during a journey.

- **Children in a child restraint system:** whether the front-passenger front air bag is enabled or deactivated depends on the installed child restraint system, and the age and size of the child. Therefore, be sure to observe the notes on the "Occupant Classification System (OCS)" (▷ page 48) and on "Children in the vehicle" (▷ page 56). There you will also find instructions on rearward and forward-facing child restraint systems on the front-passenger seat.
- **All other persons:** depending on the classification of the person in the front-passenger seat, the front-passenger front air bag is enabled or deactivated (▷ page 48). Be sure to observe the notes on "Seat belts" (▷ page 41) and "Air bags" (▷ page 45). There you can also find information on the correct seat position.

Seat belts

Introduction

Seat belts are the most effective means of restricting the movement of vehicle occupants in the event of an accident or the vehicle rolling over. This reduces the risk of vehicle occupants coming into contact with parts of the vehicle interior or being ejected from the vehicle. Furthermore, the seat belt helps to keep the vehicle occupant in the best position in relation to the air bag.

The seat belt system comprises:

- Seat belts
- Emergency Tensioning Devices for the front seat belts and the outer seat belts in the rear
- Seat belt force limiters for the front seat belts and the outer seat belts in the rear

If the seat belt is pulled by the seat belt extender quickly or with a jerky movement, the belt retractor locks. The belt strap cannot be extracted any further.

The Emergency Tensioning Device tightens the seat belt in an accident, pulling the belt close against the body. However it does not pull the vehicle occupant back in the direction of the backrest.

The Emergency Tensioning Device does not correct an incorrect seat position or the routing of an incorrectly fastened seat belt.

When triggered, a seat belt force limiter helps to reduce the force exerted by the seat belt on the vehicle occupant.

The seat belt force limiters for the front seats are synchronized with the front air bags, which absorb part of the deceleration force. This can reduce the force exerted on the vehicle occupants during an accident.

! If the front-passenger seat is not occupied, do not engage the seat belt tongue in the buckle on the front-passenger seat. Otherwise, in the event of an accident, the Emergency Tensioning Device and front-passenger front air bag may be triggered and would need to be replaced.

Important safety notes

The use of seat belts and child restraint systems is required by law in:

- all 50 states
- the U.S. territories
- the District of Columbia
- all Canadian provinces

Even where this is not required by law, all vehicle occupants should correctly fasten their seat belts before starting the journey.

WARNING

If the seat belt is incorrectly fastened, it cannot protect as intended. Furthermore, an incorrectly fastened seat belt can cause additional injury, for example, in an accident, dur-

ing braking or when abruptly changing direction. This poses an increased risk of injury or even fatal injury.

Make sure that all vehicle occupants are seated properly with a correctly fastened seat belt.

WARNING

The seat belt does not offer the intended level of protection if you have not moved the backrest to an almost vertical position. When braking or in the event of an accident, you could slide underneath the seat belt and sustain abdomen or neck injuries, for example. This poses an increased risk of injury or even fatal injury.

Adjust the seat properly before beginning your journey. Always ensure that the backrest is in an almost vertical position and that the shoulder section of your seat belt is routed across the center of your shoulder.

WARNING

Persons under 5 ft (1.50 m) in height cannot fasten the seat belt correctly without an additional suitable restraint system. If the seat belt is incorrectly fastened, it cannot protect as intended. Furthermore, an incorrectly fastened seat belt can cause additional injury, for example, in an accident, during braking or an abrupt change of direction. This poses an increased risk of injury or even fatal injury.

For this reason, always secure persons under 5 ft (1.50 m) in height in suitable restraint systems.

If a child younger than twelve years old and under 5 ft (1.50 m) in height is traveling in the vehicle:

- always secure the child in a child restraint system suitable for this Mercedes-Benz vehicle. The child restraint system must be appropriate to the age, weight and size of the child
- always observe the instructions and safety notes on "Children in the vehicle" (▷ page 56) in addition to the child restraint

system manufacturer's installation and operating instructions

- be sure to observe the instructions and safety notes on the "Occupant classification system (OCS)" (▷ page 48)

WARNING

The seat belts may not perform their intended protective function if:

- they are damaged, modified, extremely dirty, bleach or dyed
- the seat belt buckle is damaged or extremely dirty
- the Emergency Tensioning Devices, belt anchorages or inertia reels have been modified

Seat belts may sustain non-visible damage in an accident, e.g. due to glass splinters. Modified or damaged seat belts may tear or fail, e.g. in an accident. Modified Emergency Tensioning Devices could accidentally trigger or fail to deploy when necessary. This poses an increased risk of injury or even fatal injury.

Never modify the seat belts, Emergency Tensioning Devices, belt anchorages or inertia reels. Make sure that the seat belts are undamaged, not worn out and clean. Following an accident, have the seat belts checked immediately at a qualified specialist workshop.

Only use seat belts that have been approved for your vehicle by Mercedes-Benz.

Proper use of the seat belts

Pay attention to the safety notes about the seat belt (▷ page 42).

All vehicle occupants must fasten the seat belt correctly before setting off. Make sure that all occupants are wearing their seat belts correctly for the entire journey.

When fastening the seat belt, make sure that:

- The seat belt tongue is inserted into the belt buckle that belongs to the seat.
- The seat belt is tightened across your body. Avoid wearing bulky clothing, e.g. a winter coat.
- The seat belt is not twisted.

Only then can the forces produced in the event of an accident be evenly distributed across the belt.

- The shoulder section of the belt must always be routed across the center of the shoulder. The shoulder section of the belt should not come into contact with your neck and must not be routed under the arm.
- The lap belt must be taut and as low as possible over your lap. The lap belt must always pass across your hip joints and never across your stomach or abdomen. Pregnant women must take particular care. If necessary, the lap belt can be pushed down across the hip joints and pulled tight using the shoulder section.
- The seat belt is not routed over sharp, pointed or fragile objects.

If these items are on or in your clothing, e.g. eyeglasses, pens, keys, etc., stow these items in a more suitable location.

- Only one person should use each seat belt at any one time.

On no account should babies or children travel sitting on the lap of another vehicle occupant. During an accident, they could be crushed between the occupant and seat belt.

- Objects are not secured with a seat belt if the seat belt is being used by one of the vehicle's occupants.

Also make sure that there are no objects, e.g. cushions, between the occupant and the seat.

Seat belts are solely intended for the protection and restraint of the vehicle occupants. To secure objects, luggage or loads, always observe the "Loading guidelines" (▷ page 235).

Fastening a seat belt

Observe the safety notes on the seat belt (▷ page 42) and the notes on correct use of seat belts (▷ page 43).

WARNING

If the seat-belt extender is extended during the journey, the seat belt is not fitted properly on the body. The seat belt can then no longer perform its intended protective function. This poses an increased risk of injury or even fatal injury.

Always make sure that the seat-belt extender is retracted during a journey.

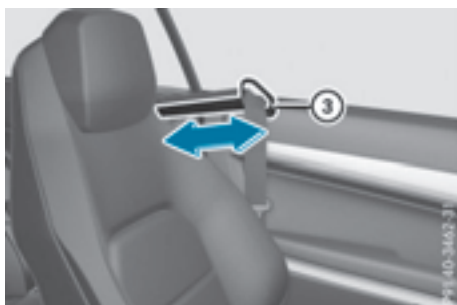

The seat-belt extender for the driver and front passenger helps you fasten your seat belt. Seat-belt extender (3) is extended when the respective door is closed and the SmartKey is turned to position 1 or 2 in the ignition lock.



You can also extend seat-belt extender (3) with seat-belt extender button (4).

- ▶ Press seat-belt extender button (4).
Seat-belt extender (3) extends.

Seat-belt extender (3) is retracted again if:

- the belt tongue is engaged in the seat belt buckle.
- the belt tongue is not engaged in the seat belt buckle within 60 seconds.
- the respective door is opened.
- the SmartKey is turned to position 0 in the ignition lock.
- you release the seat backrest and fold it forwards.
- the front-passenger seat is unoccupied after approximately five seconds.

If you press seat-belt extender button (4) after this, seat-belt extender (3) will not extend.



Basic illustration

- ▶ Adjust the seat (▷ page 91).
The seat backrest must be in an almost vertical position.
- ▶ Pull the seat belt smoothly out of seat-belt extender (3) and engage belt tongue (2) into belt buckle (1).
The seat belt on the driver's seat and the front-passenger seat may be tightened automatically, see "Belt adjustment" (▷ page 45).
- ▶ If necessary, pull upwards on the shoulder section of the seat belt to tighten the belt across your body.

In order to attach the child restraint system securely in the vehicle, the seat belts in the rear are equipped with a special seat belt retractor. Further information can be found under "Special seat belt retractor" (▷ page 57).

Automatic comfort-install feature

The front seat belts have an automatic comfort-install feature. The automatic comfort-fit feature reduces the retraction force of the seat belts. The seat belts are thus routed more comfortably for the driver and front passenger.

Releasing seat belts

- ❗ Make sure that the seat belt is fully rolled up. Otherwise, the seat belt or belt tongue will be trapped in the door or in the seat mechanism. This could damage the door, the door trim panel and the seat belt. Damaged seat belts

can no longer fulfill their protective function and must be replaced. Visit a qualified specialist workshop.

- ▶ Press the release button in the belt buckle, hold the belt tongue firmly and guide the belt back.

Seat belt adjustment

The seat-belt adjustment is an integral part of the PRE-SAFE® convenience function. This function adjusts the driver's and front-passenger seat belt to the upper body of the occupants.

The belt strap is tightened slightly when:



- the belt tongue is engaged in the buckle when the seat-belt extender is retracted and
- the ignition is switched on

The seat-belt adjustment will apply a certain retraction force if any slack is detected between the vehicle occupant and the seat belt. Do not hold on to the seat belt tightly while it is adjusting.

You can switch the seat-belt adjustment on and off in the on-board computer (▷ page 196).

Belt warning for the driver and front passenger

The  seat belt warning lamp in the instrument cluster is a reminder that all vehicle occupants must wear their seat belts. It may light up continuously or flash. In addition, there may be a warning tone.

Regardless of whether the driver's seat belt has already been fastened, the  seat belt warning lamp lights up for six seconds each time the engine is started. If, after six seconds, the driver or front-passenger seat belt has not been fastened and the doors are closed, the  seat belt warning lamp lights up. As soon as the driver's and front-passenger seat belts are fastened or a front door is opened again, the  seat belt warning lamp goes out.

If the driver's seat belt is not fastened after the engine is started, an additional warning tone will sound. The warning tone switches off after six seconds or once the driver's seat belt is fastened.

If the vehicle's speed exceeds 15 mph (25 km/h) once and the driver's and front-passenger seat belts are not fastened, a warning tone sounds. A warning tone also sounds with

increasing intensity for 60 seconds or until the driver or front passenger have fastened their seat belts.

If the driver or front passenger unfasten their seat belts during the journey, the seat belt warning is activated again.

- ❗ More information on the  seat belt warning lamp can be found under "Warning and indicator lamps in the instrument cluster, seat belt" (▷ page 220).

Air bags

Introduction

The air bag installation point is identified by the label AIR BAG.

An air bag supplements a correctly fastened seat belt. However, it is not intended as a substitute for the seat belt. Air bags provide additional protection in the event of an accident.

Not all air bags are deployed in an accident. The various air bag systems work independently of each other (▷ page 52).

There is, however, no system available today that can completely rule out injury or death.

It is also not possible to rule out a risk of injury caused by an air bag due to the high speed at which the air bag must be deployed.

Important safety notes

WARNING

If you do not sit in the correct seat position, the air bag cannot protect as intended and could even cause additional injury when deployed. This poses an increased risk of injury or even fatal injury.

To avoid hazardous situations, always make sure that all of the vehicle's occupants:

- have fastened their seat belts correctly, including pregnant women
- are sitting correctly and maintain the greatest possible distance to the air bags
- follow the following instructions

Always make sure that there are no objects between the air bag and the vehicle's occupants.

- Adjust the seats properly before beginning your journey. Always make sure that the seat is in an almost upright position. The center of the head restraint must support the head at about eye level.
- Move the driver's and front-passenger seats as far back as possible. The driver's seat position must allow the vehicle to be driven safely.
- Only hold the steering wheel on the outside. This allows the air bag to be fully deployed.
- Always lean against the backrest while driving. Do not lean forwards or lean against the door or side window. You may otherwise be in the deployment area of the air bags.
- Always keep your feet in the footwell in front of the seat. Do not put your feet on the dashboard, for example. Your feet may otherwise be in the deployment area of the air bag.
- For this reason, always secure persons less than 5 ft (1.50 m) tall in suitable restraint systems. Up to this height, the seat belt cannot be worn correctly.

If a child is traveling in your vehicle, also observe the following notes:

- Always secure children under twelve years of age and less than 5 ft (1.50 m) tall in suitable child restraint systems.
- Child restraint systems should be installed on the rear seats.
- Only secure a child in a rearward-facing child restraint system on the front-passenger seat when the front-passenger front air bag is deactivated. If the PASSENGER AIR BAG OFF indicator lamp is permanently lit, the front-passenger front air bag is deactivated (▷ page 41).
- Always observe the instructions and safety notes on the "Occupant Classification System (OCS)" (▷ page 48) and on "Children in the vehicle" (▷ page 56) in addition to the child restraint system manufacturer's installation and operating instructions.

Objects in the vehicle interior may prevent an air bag from functioning correctly. Before starting your journey and to avoid risks resulting from the speed of the air bag as it deploys, make sure that:

- there are no people, animals or objects between the vehicle occupants and an air bag.
- there are no objects between the seat, door and B-pillar.

- no hard objects, e.g. coat hangers, hang on the grab handles or coat hooks.
- no accessories, such as cup holders, are attached to the vehicle within the deployment area of an air bag, e.g. to doors, side windows, rear side trim or side walls.
- no heavy, sharp-edged or fragile objects are in the pockets of your clothing. Store such objects in a suitable place.

WARNING

If you modify the air bag cover or affix objects such as stickers to it, the air bag can no longer function correctly. There is an increased risk of injury.

Never modify an air bag cover or affix objects to it.

WARNING

Sensors to control the air bags are located in the doors. Modifications or work not performed correctly to the doors or door paneling, as well as damaged doors, can lead to the function of the sensors being impaired. The air bags might therefore not function properly anymore. Consequently, the air bags cannot protect vehicle occupants as they are designed to do. There is an increased risk of injury.

Never modify the doors or parts of the doors. Always have work on the doors or door paneling carried out at a qualified specialist workshop.

Front air bags



Driver's air bag ① deploys in front of the steering wheel. Front-passenger front air bag ② deploys in front of and above the glove box. When deployed, the front air bags offer additional head and thorax protection for the occupants in the front seats.

The PASSENGER AIR BAG OFF indicator lamp informs you about the status of the front-passenger front air bag (▷ page 41).

The front-passenger front air bag will only deploy if:

- the system, based on the OCS weight sensor readings, detects that the front-passenger seat is occupied (▷ page 48)
- the PASSENGER AIR BAG OFF indicator lamp does not light up (▷ page 49)
- the restraint system control unit predicts a high accident severity

Driver's knee bag



Driver's knee bag ① deploys under the steering column. The driver's knee bag is triggered together with the front air bag.

The driver's knee bag offers additional thigh, knee and lower leg protection for the occupant in the driver's seat.

Side impact air bags

WARNING

Unsuitable seat covers could restrict or even prevent the deployment of the air bags integrated into the seats. Consequently, the air bags cannot protect vehicle occupants as they are designed to do. In addition, the function of the Occupant Classification System (OCS) could be restricted. This poses an increased risk of injury or even fatal injury.

You should only use seat covers that have been approved for the respective seat by Mercedes-Benz.

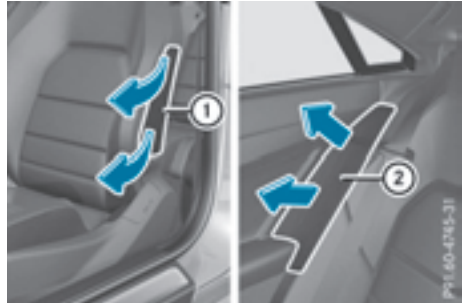

Front side impact air bags ① and rear side impact air bags ② deploy next to the outer bolster of the seat backrest.

When deployed, the side impact air bag offers additional thorax protection. However, it does not protect the:

- head
- neck
- arms

In the event of a side impact, the side impact air bag is deployed on the side on which the impact occurs.

The side impact air bag on the front-passenger side (front) deploys under the following conditions:

- the OCS system detects that the front-passenger seat is occupied or
- the belt tongue is engaged in the belt buckle of the front-passenger seat

If the belt tongue is engaged in the belt buckle, the side impact air bag on the front-passenger side deploys if an appropriate accident situation occurs. In this case, deployment is independent of whether the front-passenger seat is occupied or not.

Pelvis air bags

WARNING

Unsuitable seat covers could restrict or even prevent the deployment of the air bags integrated into the seats. Consequently, the air bags cannot protect vehicle occupants as they are designed to do. In addition, the func-

tion of the Occupant Classification System (OCS) could be restricted. This poses an increased risk of injury or even fatal injury. You should only use seat covers that have been approved for the respective seat by Mercedes-Benz.



Pelvis air bags ① deploy below next to the outer seat cushions.

When activated, the pelvis air bag enhances the level of protection of the vehicle occupants on the side of the vehicle on which the impact occurs.

The pelvis air bag is deployed on the side of the impact.

The pelvis air bag on the front-passenger side does not deploy under the following conditions:

- OCS has detected that the front-passenger seat is unoccupied.
- the front-passenger seat belt is not fastened.

If the belt tongue is engaged in the belt buckle, the pelvis air bag on the front-passenger side deploys if an appropriate accident situation occurs. In this case, deployment is independent of whether the front-passenger seat is occupied or not.

Window curtain air bags

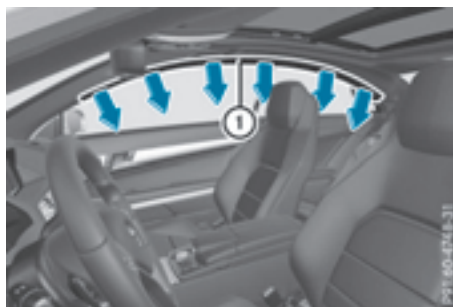

Window curtain air bags ① are integrated into the side of the roof frame and deployed in the area from the A-pillar to the C-pillar.

When deployed, the window curtain air bag enhances the level of protection for the head. However, it does not protect the chest or arms.

In the event of a side impact, the window curtain air bag is deployed on the side on which the impact occurs.

If the system determines that they can offer additional protection to that provided by the seat belt, a window curtain air bag may be deployed in other accident situations (> page 52).

Occupant Classification System (OCS)

Introduction

The Occupant Classification System (OCS) categorizes the person in the front-passenger seat. Depending on that result, the front-passenger front air bag is either enabled or deactivated.

The system does not deactivate:

- the side impact air bag
- the pelvis air bag
- the window curtain air bag
- the Emergency Tensioning Devices

Prerequisites

To be classified correctly, the front passenger must sit:

- with the seat belt fastened correctly
 - in an almost upright position with their back against the seat backrest
 - with their feet resting on the floor, if possible
- If the front passenger does not observe these conditions, OCS may produce a false classification, e.g. because the front passenger:
- transfers their weight by supporting themselves on a vehicle armrest
 - sits in such a way that their weight is raised from the seat cushion

If it is absolutely necessary to install a child restraint system on the front-passenger seat, be sure to observe the correct positioning of the child restraint system. Never place objects under or behind the child restraint system, e.g. cushions. The entire base of the child restraint system must always rest on the seat cushion of the front-passenger seat. The backrest of the forward-facing child restraint system must lie as flat as possible against the backrest of the front-passenger seat.

The child restraint system must not touch the roof or be subjected to a load by the head restraint. Adjust the angle of the seat backrest and the head restraint position accordingly.

Only then can OCS be guaranteed to function correctly. Always observe the child restraint system manufacturer's installation instructions.

Occupant Classification System operation (OCS)



PASSENGER AIRBAG OFF indicator lamp ① indicates whether the front-passenger front air bag is disabled.

- ▶ Turn the SmartKey to position **1** or **2** in the ignition lock, or in vehicles with KEYLESS-GO, press the start/stop button once or twice. The system carries out a self-diagnosis test.

The PASSENGER AIR BAG OFF indicator lamp must light up for about six seconds.

The PASSENGER AIR BAG OFF indicator lamp then shows the status of the front-passenger front air bag. If the status of the front-passenger front air bag changes whilst the vehicle is in motion, an air bag display message may appear in the instrument cluster (▷ page 204). Always observe the PASSENGER AIR BAG OFF indicator lamp when the front-passenger seat is occupied. Make sure that the status of the front-passenger front air bag is correct before and during a journey.

If the PASSENGER AIRBAG OFF indicator lamp:

- **lights up**, the front-passenger front air bag is disabled. It will then not be deployed in the event of an accident.
- **does not light up**, the front-passenger front air bag is enabled. If, in the case of an accident, all deployment criteria are met, the front-passenger front air bag is deployed.

⚠ WARNING

If the PASSENGER AIR BAG OFF indicator lamp is lit, the front-passenger front air bag is disabled. It will not be deployed in the event of an accident and cannot perform its intended protective function. A person in the front-passenger seat could then, for example, come into contact with the vehicle's interior, especially if the person is sitting too close to the dashboard. This poses an increased risk of injury or even fatal injury.

When the front-passenger seat is occupied, always ensure that:

- the classification of the person in the front-passenger seat is correct and the front-passenger front air bag is enabled or disa-

bled in accordance with the person in the front-passenger seat

- the front-passenger seat has been moved back as far back as possible.
- the person is seated correctly.

Make sure, both before and during the journey, that the status of the front-passenger front air bag is correct.

WARNING

If you secure a child in a child restraint system on the front-passenger seat and the PASSENGER AIR BAG OFF indicator lamp is off, the front-passenger front air bag can deploy in the event of an accident. The child could be struck by the air bag. This poses an increased risk of injury or even fatal injury.

Make sure that the front-passenger front air bag has been disabled. The PASSENGER AIR BAG OFF indicator lamp must be lit.

WARNING

If you secure a child in a forward-facing child restraint system on the front-passenger seat and you position the front-passenger seat too close to the dashboard, in the event of an accident, the child could:

- come into contact with the vehicle's interior if the PASSENGER AIR BAG OFF indicator lamp is lit, for example
- be struck by the air bag if the PASSENGER AIR BAG OFF indicator lamp is off

This poses an increased risk of injury or even fatal injury.

Move the front-passenger seat as far back as possible. Always make sure that the shoulder belt strap is correctly routed from the vehicle seat-belt extender to the shoulder belt guide on the child restraint system. The shoulder belt strap must be routed forwards and downwards from the retracted vehicle seat-belt extender. If necessary, adjust the front-passenger seat accordingly. Always observe the child restraint system manufacturer's installation instructions.

If OCS detects that:

- the front-passenger seat is not occupied, the PASSENGER AIR BAG OFF indicator lamp lights up continuously after the system's self-diagnosis test. This indicates that the front-passenger front air bag is deactivated.
- the front-passenger seat is occupied by a child aged up to twelve months in a standard child restraint system, the PASSENGER AIR BAG OFF indicator lamp lights up continuously after the system's self-diagnosis test. This indicates that the front-passenger front air bag is deactivated.

In the case of a twelve-month-old child in a standard child restraint system, the PASSENGER AIR BAG OFF indicator lamp may go out after the system's self-diagnosis test. This indicates that the front-passenger front air bag is activated. Categorization is dependent on the type of child restraint system and the stature of the child, for example. In this case, always install the child restraint system on a suitable rear seat.

- the front-passenger seat is occupied by a person of smaller stature (e.g. a teenager or a small adult), the PASSENGER AIR BAG OFF indicator lamp lights up continuously or goes off after the system's self-diagnosis test depending on the categorization.
 - If the PASSENGER AIR BAG OFF indicator lamp is off, position the front-passenger seat as far back as possible. Alternatively, a person of smaller stature can sit on a rear seat.
 - If the PASSENGER AIR BAG OFF indicator lamp lights up, a person of smaller stature should not sit on the front-passenger seat.
- the front-passenger seat is occupied by an adult or a person of an appropriate size, the PASSENGER AIR BAG OFF indicator lamp goes out after the system's self-diagnosis test. This indicates that the front-passenger front air bag is activated.

If children are traveling in the vehicle, be sure to observe the notes on "Children in the vehicle" (> page 56).

If the OCS is malfunctioning, both the red  restraint system warning lamp in the instrument cluster and the PASSENGER AIR BAG OFF indicator lamp light up simultaneously. In this case, the front-passenger air bag is deactivated and does not deploy during an accident. Have the system checked by qualified technicians as

soon as possible. Consult an authorized Mercedes-Benz Center. Only have the front-passenger seat repaired at an authorized Mercedes-Benz Center.

If the front-passenger seat, the seat cover or the seat cushion are damaged, have the necessary repair work carried out at an authorized Mercedes-Benz Center.

For safety reasons, Mercedes-Benz recommends that you only use seat accessories that have been approved by Mercedes-Benz.

If the driver's air bag deploys, this does not mean that the front-passenger front air bag will also deploy. The Occupant Classification System (OCS) categorizes the occupant on the front-passenger seat. Depending on the result, the front-passenger air bag is activated or deactivated.

System self-test

DANGER

If the PASSENGER AIR BAG OFF indicator lamp does not light up during the system self-test, then the system is malfunctioning. The front-passenger front air bag might be triggered unintentionally or might not be triggered at all in the event of an accident with high deceleration. This poses an increased risk of injury or even fatal injury.

In this case the front-passenger seat may not be used. Do not install a child restraint system on the front-passenger seat. Have the Occupant Classification System (OCS) checked and repaired immediately at a qualified specialist workshop.

WARNING

If the PASSENGER AIR BAG OFF indicator lamp remains lit after the system self-test, the front-passenger front air bag is disabled. It will not be deployed in the event of an accident. In this case, the front-passenger front air bag cannot perform its intended protective function, e.g. when a person is seated in the front-passenger seat.

That person could, for example, come into contact with the vehicle's interior, especially if the person is sitting too close to the dash-

board. This poses an increased risk of injury or even fatal injury.

When the front-passenger seat is occupied, always ensure that:

- the classification of the person in the front-passenger seat is correct and the front-passenger front air bag is enabled or disabled in accordance with the person in the front-passenger seat
- the person is seated properly with a correctly fastened seatbelt
- the front-passenger seat has been moved as far back as possible

If the PASSENGER AIR BAG OFF indicator lamp remains lit when it should not, the front-passenger seat may not be used. Do not install a child restraint system on the front-passenger seat. Have the Occupant Classification System (OCS) checked and repaired immediately at a qualified specialist workshop.

WARNING

Objects between the seat surface and the child restraint system could affect OCS operation. This could result in the front-passenger air bag not functioning as intended during an accident. This poses an increased risk of injury or even fatal injury.

Do not place any objects between the seat surface and the child restraint system. The entire base of the child restraint system must always rest on the seat cushion of the front-passenger seat. The backrest of the forward-facing child restraint system must, as far as possible, be resting on the backrest of the front-passenger seat. Always comply with the child restraint system manufacturer's installation instructions.

After the system self-test, the PASSENGER AIR BAG OFF indicator lamp displays the status of the front-passenger front air bag (> page 49). For more information about the OCS, see "Problems with the Occupant Classification System" (> page 52).

Problems with the Occupant Classification System (OCS)

Be sure to observe the notes on "System self-test" (▷ page 51).

| Problem | Possible causes/consequences and ► Solutions |
|--|--|
| The PASSENGER AIR BAG OFF indicator lamp lights up and remains lit, even though the front-passenger seat is occupied by an adult or a person of a stature corresponding to that of an adult. | <p>The classification of the person on the front-passenger seat is incorrect.</p> <ul style="list-style-type: none"> ► Make sure the conditions for a correct classification of the person on the front-passenger seat are met (▷ page 49). ► If the PASSENGER AIR BAG OFF indicator lamp remains lit, the front-passenger seat may not be used. ► Have OCS checked as soon as possible at an authorized Mercedes-Benz Center. |
| <p>The PASSENGER AIR BAG OFF indicator lamp does not light up and/or does not stay on.</p> <p>The front-passenger seat is:</p> <ul style="list-style-type: none"> • unoccupied • occupied with the weight of a child up to twelve months old in a child restraint system | <p>OCS is malfunctioning.</p> <ul style="list-style-type: none"> ► Make sure there is nothing between the seat cushion and the child seat. ► Make sure that the entire base of the child restraint system rests on the seat cushion of the front-passenger seat. The backrest of the forward-facing child restraint system must lie as flat as possible against the backrest of the front-passenger seat. If necessary, adjust the position of the front-passenger seat. ► When installing the child restraint system, make sure that the seat belt is tight. Do not pull the seat belt tight using the front-passenger seat adjustment. This could result in the seat belt and the child restraint system being pulled too tightly. ► Check for correct installation of the child restraint system. Make sure that the head restraint does not apply a load to the child restraint system. If necessary, adjust the head restraint accordingly. ► Make sure that no objects are applying additional weight onto the seat. ► If the PASSENGER AIR BAG OFF indicator lamp remains off, do not install a child restraint system on the front-passenger seat. It is recommended that you install the child restraint system on a suitable rear seat. ► Have OCS checked as soon as possible at an authorized Mercedes-Benz Center. |

Deployment of Emergency Tensioning Devices and air bags

Important safety notes

WARNING

The air bag parts are hot after an air bag has been deployed. There is a risk of injury.

Do not touch the air bag parts. Have a deployed air bag replaced at a qualified specialist workshop as soon as possible.

WARNING

A deployed air bag no longer offers any protection and cannot provide the intended protection in an accident. There is an increased risk of injury.

Have the vehicle towed to a qualified specialist workshop in order to have a deployed air bag replaced.

It is important for your safety and that of your passenger to have deployed air bags replaced and to have any malfunctioning air bags repaired. This will help to make sure the air bags continue to perform their protective function for the vehicle occupants in the event of a crash.

WARNING

Pyrotechnic Emergency Tensioning Devices that have been deployed are no longer operational and are unable to perform their intended protective function. This poses an increased risk of injury or even fatal injury.

Therefore, have pyrotechnic Emergency Tensioning Devices which have been triggered immediately replaced at a qualified specialist workshop.

An electric motor is used by PRE-SAFE® to trigger the tightening of the seat belt in hazardous situations. This procedure is reversible.

If Emergency Tensioning Devices are triggered or air bags are deployed, you will hear a bang, and a small amount of powder may also be released. The  restraint system warning lamp lights up.

Only in rare cases will the bang affect your hearing. The powder that is released generally does not constitute a health hazard, but it may cause short-term breathing difficulties in people with asthma or other respiratory problems. Provided it is safe to do so, you should leave the vehicle immediately or open the window in order to prevent breathing difficulties.

Air bags and pyrotechnic Emergency Tensioning Devices (ETDs) contain perchlorate material, which may require special handling and regard for the environment. National guidelines must be observed during disposal. In California, see www.dtsc.ca.gov/HazardousWaste/Perchlorate/index.cfm.

Method of operation

During the first stage of a collision, the restraint system control unit evaluates important physical data relating to vehicle deceleration or acceleration, such as:

- duration
- direction
- intensity

Based on the evaluation of this data, the restraint system control unit triggers the Emergency Tensioning Devices during a frontal or rear collision.

An Emergency Tensioning Device can only be triggered, if:

- the ignition is switched on
- the components of the restraint system are operational. You can find further information under: "Restraint system warning lamp" (▷ page 40)
- the belt tongue is engaged in the buckle on the respective front-passenger seat

The Emergency Tensioning Devices in the rear compartment are triggered independently of the lock status of the seat belts.

If the restraint system control unit detects a more severe accident, further components of the restraint system are activated independently of each other in certain frontal collision situations:

- Front air bags and driver's knee bag
- Window curtain air bag, if the system determines that deployment can offer additional protection to that provided by the seat belt

The front-passenger front air bag is activated or deactivated depending on the person on the front-passenger seat. The front-passenger front air bag can only deploy in an accident if the PASSENGER AIR BAG OFF indicator lamp is off. Observe the information on the PASSENGER AIR BAG OFF indicator lamp (▷ page 41).

Your vehicle has two-stage front air bags. During the first deployment stage, the front air bag is filled with propellant gas to reduce the risk of injuries. The front air bag is fully deployed with the maximum amount of propellant gas if a second deployment threshold is reached within a few milliseconds.

The activation threshold of the Emergency Tensioning Devices and the air bag are determined by evaluating the rate of vehicle deceleration or acceleration which occurs at various points in

the vehicle. This process is pre-emptive in nature. Deployment should take place in good time at the start of the collision.

The rate of vehicle deceleration or acceleration and the direction of the force are essentially determined by:

- the distribution of forces during the collision
- the collision angle
- the deformation characteristics of the vehicle
- the characteristics of the object with which the vehicle has collided

Factors which can only be seen and measured after a collision has occurred do not play a decisive role in the deployment of an air bag. Nor do they provide an indication of air bag deployment.

The vehicle can be deformed considerably, without an air bag being deployed. This is the case if only parts which are relatively easily deformed are affected and the rate of deceleration is not high. Conversely, air bags may be deployed even though the vehicle suffers only minor deformation. This is the case if, for example, very rigid vehicle parts such as longitudinal body members are hit, and sufficient deceleration occurs as a result.

If the restraint system control unit detects a side impact, the applicable components of the restraint system are activated independently of each other.

- Side impact air bags and pelvis air bag on the side of impact, independently of the Emergency Tensioning Device and the use of the seat belt on the driver's seat and in the rear compartment seats

The side impact air bag on the front-passenger side (front) deploys under the following conditions:

- the OCS system detects that the front-passenger seat is occupied or
- the belt tongue is engaged in the belt buckle of the front-passenger seat
- Window curtain air bag on the side of impact, independently of the use of the seat belt and independently of whether the front-passenger seat is occupied
- Emergency Tensioning Devices, if the system determines that deployment can offer additional protection in this situation

i Not all air bags are deployed in an accident. The different air bag systems work independently of each other.

How the air bag system works is determined by the severity of the accident detected, especially the vehicle deceleration or acceleration and the apparent type of accident:

- Frontal collision
- Side impact

NECK-PRO head restraints

Important safety notes

WARNING

The function of the head restraint may be impaired if you:

- attach objects such as coat hangers to the head restraints, for example
- use head restraint covers

If you do so, the head restraints cannot fulfill their intended protective function in the event of an accident. In addition, objects attached to the head restraints could endanger other vehicle occupants. There is an increased risk of injury.

Do not attach any objects to the head restraints and do not use head restraint covers.

Method of operation

NECK-PRO head restraints reduce the likelihood of head and chest injuries. The NECK-PRO head restraints on the driver's and front-passenger seats are moved forwards and upwards in the event of a rear-end collision of a certain severity. This provides better head support.

If the NECK-PRO head restraints have been triggered in an accident, you must reset the NECK-PRO head restraints on the driver's and front-passenger seat (▷ page 55). Otherwise, the additional protection will not be available in the event of another rear-end collision. You can recognize when NECK-PRO head restraints have been triggered by the fact that they have moved forwards and can no longer be adjusted.

Mercedes-Benz recommends that you have the NECK-PRO head restraints checked for functionality at a qualified specialist workshop after a rear-end collision.

Resetting triggered NECK-PRO head restraints

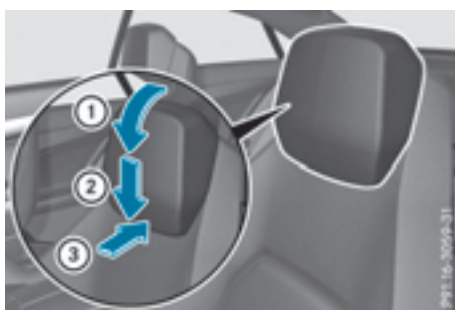

Do not insert your finger between the upholstery of the head restraint and the seat. Pay particular attention while resetting the NECK-PRO head restraints.

- ▶ Tilt the top of the NECK-PRO head restraint cushion forwards in the direction of arrow ①.
- ▶ Push the NECK-PRO head restraint cushion down as far as it will go in the direction of arrow ②.
- ▶ Firmly push the NECK-PRO head restraint cushion back in the direction of arrow ③ until the cushion engages.
- ▶ Repeat this procedure for the second NECK-PRO head restraint.

i Resetting the NECK-PRO head restraints requires a lot of strength. If you have difficulty resetting the NECK-PRO head restraints, have this work carried out at a qualified specialist workshop.

PRE-SAFE® (anticipatory occupant protection system)

Introduction

In certain hazardous situations, PRE-SAFE® takes pre-emptive measures to protect the vehicle occupants.

Important safety notes

! Make sure that there are no objects in the footwell or behind the seats. There is a danger that the seats and/or objects could be damaged when PRE-SAFE® is activated.

Although your vehicle is equipped with PRE-SAFE®, the possibility of injury in the event of an accident cannot be ruled out. Always adapt your driving style to suit the prevailing road and weather conditions and maintain a safe distance from the vehicle in front. Drive carefully.

Function

PRE-SAFE® intervenes:

- in emergency braking situations, e.g. when BAS is activated
- in critical driving situations, e.g. when physical limits are exceeded and the vehicle understeers or oversteers severely
- on vehicles with the Driving Assistance package: if BAS PLUS intervenes powerfully or the radar sensor system detects an imminent danger of collision in certain situations

PRE-SAFE® takes the following measures depending on the hazardous situation detected:

- the front seat belts are pre-tensioned.
- the front-passenger seat is adjusted if it is in an unfavorable position.
- if the vehicle skids, the front side windows and the panorama roof with power tilt/sliding panel are closed.
- the air pressure in the side bolsters of the seat backrests of the front multicontour seats is raised.

If the hazardous situation passes without resulting in an accident, PRE-SAFE® slackens the belt pre-tensioning. On vehicles with multicontour seats, the air pressure in the side bolsters is reduced again. All settings made by PRE-SAFE® can then be reversed.

If the seat belt pre-tensioning is not reduced:

- ▶ Move the seat backrest or seat back slightly when the vehicle is stationary.
The seat belt pre-tensioning is reduced and the locking mechanism is released.

The seat-belt adjustment is an integral part of the PRE-SAFE® convenience function. Information about the convenience function can be found under "Belt adjustment" (▷ page 45).

PRE-SAFE® PLUS (anticipatory occupant protection system PLUS)

Introduction

PRE-SAFE® PLUS is only available in vehicles with the Driving Assistance package.

Using the radar sensor system, PRE-SAFE® PLUS is able to detect that a head-on or rear-end collision is imminent. In certain hazardous situations, PRE-SAFE® PLUS takes pre-emptive measures to protect the vehicle occupants.

Important safety notes

The intervention of PRE-SAFE® PLUS cannot prevent an imminent collision.

The driver is not warned about the intervention of PRE-SAFE® PLUS.

PRE-SAFE® PLUS does not intervene if the vehicle is backing up.

When driving, or when parking or exiting a parking space with assistance from Active Parking Assist, PRE-SAFE® PLUS will not apply the brakes.

Function

PRE-SAFE® PLUS intervenes in certain situations if the radar sensor system detects an imminent head-on or rear-end collision.

PRE-SAFE® PLUS takes the following measures depending on the hazardous situation detected:

- if the radar sensor system detects that a head-on collision is imminent, the seat belts are pre-tensioned.
- if the radar sensor system detects that a rear-end collision is imminent:
 - the brake pressure is increased if the driver applies the brakes when the vehicle is stationary.
 - the seat belts are pre-tensioned.

The PRE-SAFE® PLUS braking application is canceled:

- if the accelerator pedal is depressed when a gear is engaged
- if the risk of a collision passes or is no longer detected
- if DISTRONIC PLUS indicates an intention to pull away

If the hazardous situation passes without resulting in an accident, the original settings are restored.

Automatic measures after an accident

Immediately after an accident, the following measures are implemented, depending on the type and severity of the impact:

- the hazard warning lamps are activated
- the emergency lighting is activated
- the vehicle doors are unlocked
- the front side windows are lowered
- vehicles with a memory function: the electrically adjustable steering wheel is raised
- the engine is switched off and the fuel supply is cut off
- vehicles with mbrace: automatic emergency call

Children in the vehicle

Important safety notes

Accident statistics show that children secured in the rear seats are safer than children secured in the front-passenger seat. For this reason, Mercedes-Benz strongly advises that you install a child restraint system on a rear seat. Children are generally better protected there.

If a child younger than twelve years old and under 5 ft (1.50 m) in height is traveling in the vehicle:

- always secure the child in a child restraint system suitable for Mercedes-Benz vehicles. The child restraint system must be appropriate to the age, weight and size of the child
- be sure to observe the instructions and safety notes in this section in addition to the child restraint system manufacturer's installation instructions
- be sure to observe the instructions and safety notes on the "Occupant classification system (OCS)" (▷ page 48)

⚠ WARNING

If you leave children unsupervised in the vehicle, they could set it in motion by, for example:

- release the parking brake.
- shift the automatic transmission out of the parking position **P**.
- start the engine.

In addition, they may operate vehicle equipment and become trapped. There is a risk of an accident and injury.

When leaving the vehicle, always take the SmartKey with you and lock the vehicle. Never leave children unsupervised in the vehicle.

⚠ WARNING

If persons, particularly children are subjected to prolonged exposure to extreme heat or cold, there is a risk of injury, possibly even fatal. Never leave children unattended in the vehicle.

⚠ WARNING

If the child restraint system is subjected to direct sunlight, parts may get very hot. Children may burn themselves on these parts, particularly on the metal parts of the child restraint system. There is a risk of injury.

If you leave the vehicle, taking the child with you, always ensure that the child restraint system is not exposed to direct sunlight. Protect it with a blanket, for example. If the child restraint system has been exposed to direct sunlight, let it cool down before securing the child in it. Never leave children unattended in the vehicle.

Always ensure that all vehicle occupants have their seat belts fastened correctly and are sitting properly. Particular attention must be paid to children.

Observe the safety notes on the seat belt (▷ page 42) and the notes on correct use of seat belts (▷ page 43).

A booster seat may be necessary to achieve proper seat belt positioning for children over 41 lbs (18 kg) until they reach a height where a

three-point seat belt can be properly fastened without a booster seat.

Special seat belt retractor**⚠ WARNING**

If the seat belt is released while driving, the child restraint system will no longer be secured properly. The special seat belt retractor is disabled and the inertia reel draws in a portion of the seat belt. The seat belt cannot be immediately refastened. There is an increased risk of injury, possibly even fatal. Stop the vehicle immediately, paying attention to road and traffic conditions. Reactivate the special seat belt retractor and secure the child restraint system properly.

All seat belts except the driver's seat belt are equipped with a special seat belt retractor. When activated, the special seat belt retractor ensures that the seat belt will not slacken once the child restraint system has been secured.

Installing a child restraint system:

- ▶ Always comply with the child restraint system manufacturer's installation instructions.
- ▶ Pull the front seat belt smoothly out of the seat-belt extender and the rear seat belt out of the belt outlet.
- ▶ Engage the seat belt tongue in the belt buckle.

Activating the special seat belt retractor:

- ▶ Pull the seat belt out fully and let the inertia reel retract it again. While the seat belt is retracting, you should hear a ratcheting sound. The special seat belt retractor is activated.
- ▶ Push the child seat restraint system down so that the seat belt is tight and does not loosen.

Removing a child restraint system and deactivating the special seat belt retractor:

- ▶ Always comply with the child restraint system manufacturer's installation instructions.
- ▶ Press the release button of the belt buckle, hold the belt tongue firmly and guide it back to the seat-belt extender in the front and the belt outlet in the rear. The special seat belt retractor is deactivated.

Child restraint system

The use of seat belts and child restraint systems is required by law in:

- all 50 states
- the U.S. territories
- the District of Columbia
- all Canadian provinces

You can obtain further information about the correct child restraint system from any authorized Mercedes-Benz Center.

WARNING

If the child restraint system is installed incorrectly on a suitable seat, it cannot protect as intended. The child cannot then be restrained in the event of an accident, heavy braking or sudden changes of direction. There is an increased risk of injury, possibly even fatal.

Make sure that you observe the child restraint system manufacturer's installation instructions and the notes on use. Please ensure, that the base of the child restraint system is always resting completely on the seat cushion. Never place objects, e.g. cushions, under or behind the child restraint system. Only use child restraint systems with the original cover designed for them. Only replace damaged covers with genuine covers.

WARNING

If the child restraint system is installed incorrectly or is not secured, it can come loose in the event of an accident, heavy braking or a sudden change in direction. The child restraint system could be thrown about, striking vehicle occupants. There is an increased risk of injury, possibly even fatal.

Always install child restraint systems properly, even if they are not being used. Make sure that you observe the child restraint system manufacturer's installation instructions.

You will find further information on stowing objects, luggage or loads under "Loading guidelines" (▷ page 235).

WARNING

Child restraint systems or their securing systems which have been damaged or subjected to a load in an accident can no longer protect as intended. The child cannot then be restrained in the event of an accident, heavy braking or sudden changes of direction. There is an increased risk of injury, possibly even fatal.

Replace child restraint systems which have been damaged or subjected to a load in an accident as soon as possible. Have the securing systems on the child restraint system checked at a qualified specialist workshop, before you install a child restraint system again.

The securing systems of child restraint systems are:

- the seat belt system
- the LATCH-type (ISOFIX) securing rings
- the Top Tether anchorages

If it is absolutely necessary to carry a child on the front-passenger seat, be sure to observe the information on the "Occupant Classification System (OCS)" (▷ page 48). There you will also find information on deactivating the front-passenger front air bag.

All child restraint systems must meet the following standards:

- U.S. Federal Motor Vehicle Safety Standards 213 and 225
- Canadian Motor Vehicle Safety Standards 213 and 210.2

Confirmation that the child restraint system corresponds to the standards can be found on an instruction label on the child restraint system. This confirmation can also be found in the installation instructions that are included with the child restraint system.

Observe the warning labels in the vehicle interior and on the child restraint system.

LATCH-type (ISOFIX) child seat securing system

WARNING

LATCH-type (ISOFIX) child restraint systems do not offer sufficient protective effect for children whose weight is greater than 48 lbs (22 kg) who are secured using the safety belt integrated in the child restraint system. In the event of an accident, a child might not be restrained correctly. This poses an increased risk of injury or even fatal injury.

If the child weighs more than 48 lbs (22 kg), only use LATCH-type (ISOFIX) child restraint systems with which the child is also secured with the vehicle seat belt. Also secure the child restraint system with the Top Tether belt, if available.

Always comply with the manufacturer's installation and operating instructions for the child restraint system used.

Before every trip, make sure that the LATCH-type (ISOFIX) child restraint system is engaged correctly in both LATCH-type (ISOFIX) securing rings



Installation indicator ① shows the installation location of securing rings ②.

- ▶ Press the upholstery over both slots above LATCH-type (ISOFIX) securing rings ② to the side.
- ▶ Install the LATCH-type (ISOFIX) child restraint system on both LATCH-type (ISOFIX) securing rings ①.

ISOFIX is a standardized securing system for specially designed child restraint systems on the rear seats. LATCH-type (ISOFIX) securing rings for two LATCH-type (ISOFIX) child restraint

systems are installed on the left and right of the rear seats.

Non-LATCH-type (ISOFIX) child seats may also be used and can be installed using the vehicle's seat belt system. Install the child seat according to the manufacturer's instructions.

Top Tether

Introduction

Top Tether provides an additional connection between the child restraint system secured with a LATCH-type (ISOFIX) system and the vehicle. This helps reduce the risk of injury even further. If the child restraint system is equipped with a Top Tether belt, this should always be used.

Important safety notes

WARNING

If the rear seat backrests are not locked, they could fold forwards in the event of an accident, heavy braking or sudden changes of direction. As a result, child restraint systems cannot perform their intended protective function. Rear seat backrests that are not locked can also cause additional injuries, e.g. in the event of an accident. This poses an increased risk of injury or even fatal injury.

Always lock rear seat backrests after installing a Top Tether belt. Observe the lock verification indicator. Adjust the rear seat backrests so that they are in an upright position.

If the rear seat backrest is not engaged and locked, this will be shown in the multifunction display in the instrument cluster. A warning tone also sounds.

Top Tether anchorages



The Top Tether anchorage points are installed in the rear compartment behind the head restraints.

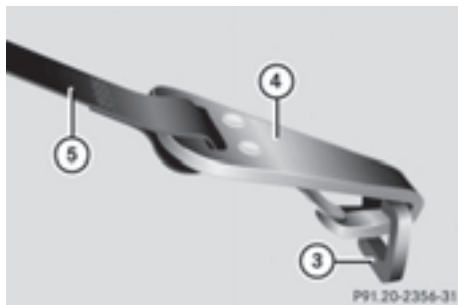

Example: Top Tether belt with one belt strap

- ▶ Press down the rear of cover ② in the direction of the arrow.
Cover ② is raised slightly at the front.
- ▶ Fold cover ② upwards.
- ▶ Install the LATCH-type (ISOFIX) child restraint system with Top Tether. Always comply with the child restraint system manufacturer's installation instructions when doing so.
- ▶ **Top Tether belt with one belt strap:** route Top Tether belt ⑤ centrally over head restraint ①.

or

- ▶ **Top Tether belt with two belt straps:** route one Top Tether belt ⑤ to the left and one to the right past the side of head restraint ①.
- ▶ Hook Top Tether hook ④ into Top Tether anchorage ③.
Make sure that Top Tether belt ⑤ is not twisted.
- ▶ Tension Top Tether belt ⑤. Always comply with the child restraint system manufacturer's installation instructions when doing so.

Child restraint system on the front-passenger seat

General notes

Accident statistics show that children secured in the rear seats are safer than children secured in the front-passenger seat. For this reason, Mercedes-Benz strongly advises that you install the child restraint system on a rear seat.

If it is absolutely necessary to install a child restraint system on the front-passenger seat, always observe the instructions and safety notes on the "Occupant Classification System (OCS)" (▷ page 48).

You can thus avoid the risks that could arise as a result of:

- an incorrectly categorized person in the front-passenger seat
- the unintentional deactivation of the front-passenger front air bag
- the unsuitable positioning of the child restraint system, e.g. too close to the dashboard

Rearward-facing child restraint system

If it is absolutely necessary to install a rearward-facing child restraint system on the front-passenger seat, always make sure that the front-passenger front air bag is deactivated. Only if the PASSENGER AIR BAG OFF indicator lamp is permanently lit (▷ page 41) is the front-passenger front air bag deactivated.

Always observe the child restraint system manufacturer's installation and operating instructions.

Forward-facing child restraint system

If you secure a child in a forward-facing child restraint system on the front-passenger seat, always move the front-passenger seat as far back as possible. The entire base of the child restraint system must always rest on the seat cushion of the front-passenger seat. The backrest of the child restraint system must lie as flat as possible against the backrest of the front-passenger seat. The child restraint system must not touch the roof or be subjected to a load by the head restraint. Adjust the angle of the seat backrest and the head restraint position accordingly. Always make sure that the shoulder belt strap is correctly routed from the seat-belt

extender of the front-passenger seat to the shoulder belt guide on the child restraint system. The shoulder belt strap must be routed forwards from the retracted seat-belt extender for the front-passenger seat.

Always observe the child restraint system manufacturer's installation and operating instructions.

Child-proof locks

Important safety notes

WARNING

If children are traveling in the vehicle, they could:

- open doors, thus endangering other people or road users
- exit the vehicle and be caught by oncoming traffic
- operate vehicle equipment and become trapped

There is a risk of an accident and injury.

Always activate the child-proof locks and override feature if children are traveling in the vehicle. When leaving the vehicle, always take the key with you and lock the vehicle. Never leave children unattended in the vehicle.

Override feature for the rear side windows (▷ page 61).

WARNING

If you leave children unsupervised in the vehicle, they could set it in motion by, for example:

- release the parking brake.
- shift the automatic transmission out of the parking position **P**.
- start the engine.

In addition, they may operate vehicle equipment and become trapped. There is a risk of an accident and injury.

When leaving the vehicle, always take the SmartKey with you and lock the vehicle. Never leave children unsupervised in the vehicle.

WARNING

If persons, particularly children are subjected to prolonged exposure to extreme heat or cold, there is a risk of injury, possibly even fatal. Never leave children unattended in the vehicle.

WARNING

If the child restraint system is subjected to direct sunlight, parts may get very hot. Children may burn themselves on these parts, particularly on the metal parts of the child restraint system. There is a risk of injury.

If you leave the vehicle, taking the child with you, always ensure that the child restraint system is not exposed to direct sunlight. Protect it with a blanket, for example. If the child restraint system has been exposed to direct sunlight, let it cool down before securing the child in it. Never leave children unattended in the vehicle.

Override feature for the rear side windows



- **To activate/deactivate:** press button ②. If indicator lamp ① is lit, operation of the rear side windows is disabled. Operation is only possible using the switches in the driver's door. If indicator lamp ① is off, operation is possible using the switches in the rear compartment.

Pets in the vehicle

WARNING

If you leave animals unattended or unsecured in the vehicle, they could press buttons or switches, for example.

As a result, they could:

- activate vehicle equipment and become trapped, for example
- activate or deactivate systems, thereby endangering other road users

Unsecured animals could also be flung around the vehicle in the event of an accident or sudden steering or braking, thereby injuring vehicle occupants. There is a risk of an accident and injury.

Never leave animals unattended in the vehicle. Always secure animals properly during the journey, e.g. use a suitable animal transport box.

Driving safety systems

Overview of driving safety systems

In this section, you will find information about the following driving safety systems:

- **ABS (Anti-lock Braking System)** (▷ page 62)
- **BAS (Brake Assist System)** (▷ page 63)
- **BAS PLUS (Brake Assist System PLUS)** with Cross-Traffic Assist (▷ page 63)
- **COLLISION PREVENTION ASSIST PLUS** (▷ page 65)
- **ESP® (Electronic Stability Program)** (▷ page 67)
- **EBD (Electronic Brake force Distribution)** (▷ page 69)
- **ADAPTIVE BRAKE** (▷ page 69)
- **PRE-SAFE® Brake** (▷ page 69)
- **STEER CONTROL** (▷ page 71)

Important safety notes

If you fail to adapt your driving style or if you are inattentive, the driving safety systems can nei-

ther reduce the risk of an accident nor override the laws of physics. Driving safety systems are merely aids designed to assist driving. You are responsible for maintaining the distance to the vehicle in front, for vehicle speed, for braking in good time, and for staying in lane. Always adapt your driving style to suit the prevailing road and weather conditions and maintain a safe distance from the vehicle in front. Drive carefully.

The driving safety systems described only work as effectively as possible when there is adequate contact between the tires and the road surface. Please pay special attention to the notes on tires, recommended minimum tire tread depths, etc. (▷ page 281).

In wintry driving conditions, always use winter tires (M+S tires) and if necessary, snow chains. Only in this way will the driving safety systems described in this section work as effectively as possible.

ABS (Anti-lock Braking System)

General information

ABS regulates brake pressure in such a way that the wheels do not lock when you brake. This allows you to continue steering the vehicle when braking.

The  ABS warning lamp in the instrument cluster lights up when the ignition is switched on. It goes out when the engine is running.

ABS works from a speed of about 5 mph (8 km/h), regardless of road-surface conditions. ABS works on slippery surfaces, even when you only brake gently.

Important safety notes

-  Observe the "Important safety notes" section (▷ page 62).

WARNING

If ABS is faulty, the wheels could lock when braking. The steerability and braking characteristics may be severely impaired. Additionally, further driving safety systems are deactivated. There is an increased danger of skidding and accidents.

Drive on carefully. Have ABS checked immediately at a qualified specialist workshop.

When ABS is malfunctioning, other systems, including driving safety systems, will also become inoperative. Observe the information on the ABS warning lamp (▷ page 222) and display messages which may be shown in the instrument cluster (▷ page 198).

Braking

- ▶ **If ABS intervenes:** continue to depress the brake pedal vigorously until the braking situation is over.
- ▶ **To make a full brake application:** depress the brake pedal with full force.

If ABS intervenes when braking, you will feel a pulsing in the brake pedal.

The pulsating brake pedal can be an indication of hazardous road conditions, and functions as a reminder to take extra care while driving.

BAS (Brake Assist System)

General information

BAS operates in emergency braking situations. If you depress the brake pedal quickly, BAS automatically boosts the braking force, thus shortening the stopping distance.

Important safety notes

- i** Observe the "Important safety notes" section (▷ page 62).

WARNING

If BAS is malfunctioning, the braking distance in an emergency braking situation is increased. There is a risk of an accident.

In an emergency braking situation, depress the brake pedal with full force. ABS prevents the wheels from locking.

Braking

- ▶ Keep the brake pedal firmly depressed until the emergency braking situation is over. ABS prevents the wheels from locking.

The brakes will function as usual once you release the brake pedal. BAS is deactivated.

BAS PLUS (Brake Assist PLUS) with Cross-Traffic Assist

General information

BAS PLUS can help you to minimize the risk of a collision with a vehicle or a pedestrian and reduce the effects of such a collision. If BAS PLUS detects a danger of collision, you are assisted when braking.

- i** Pay attention to the important safety notes in the "Driving safety systems" section (▷ page 62).

BAS PLUS is only available on vehicles with the Driving Assistance package.

For BAS PLUS to assist you when driving, the radar sensor system and the camera system must be operational.

With the help of a sensor system and a camera system, BAS PLUS can detect obstacles:

- that are in the path of your vehicle for an extended period of time
- that cross the path of your vehicle

In addition, pedestrians in the path of your vehicle can be detected.

BAS PLUS detects pedestrians by using typical characteristics such as the body contours and posture of a person standing upright.

If the radar sensor system or the camera system is malfunctioning, BAS PLUS functions are restricted or no longer available. The brake system is still available with complete brake boosting effect and BAS.

- i** Observe the restrictions described in the "Important safety notes" section (▷ page 63).

Important safety notes

WARNING

BAS PLUS cannot always clearly identify objects and complex traffic situations.

In such cases, BAS PLUS may:

- intervene unnecessarily
- not intervene

There is a risk of an accident.

Always pay careful attention to the traffic situation and be ready to brake. Terminate the intervention in a non-critical driving situation.

WARNING

BAS PLUS cannot always clearly identify people, this is especially the case if they are moving. BAS PLUS cannot intervene in these cases. There is a risk of an accident.

Always pay careful attention to the traffic situation and be ready to brake.

WARNING

BAS PLUS does not react:

- to small people, e.g. children
- to animals
- to oncoming vehicles
- when cornering

As a result, BAS PLUS may not intervene in all critical situations. There is a risk of an accident.

Always pay careful attention to the traffic situation and be ready to brake.

In the event of snowfall or heavy rain, the recognition can be impaired.

Recognition by the radar sensor system is also impaired if:

- there is dirt on the sensors or anything else covering the sensors
- there is interference by other radar sources
- there are strong radar reflections, for example in parking garages
- a narrow vehicle is traveling in front, e.g. a motorbike
- a vehicle is traveling in front on a different line
- vehicles quickly move into the radar sensor system detection range

Recognition by the camera system is also impaired in the event of:

- dirt on the camera or if the camera is covered
- glare on the camera system, e.g. from the sun being low in the sky

- darkness
- or if:
 - pedestrians move quickly, e.g. into the path of the vehicle
 - the camera system no longer recognizes a pedestrian as a person due to special clothing or other objects
 - a pedestrian is concealed by other objects
 - the typical outline of a person is not distinguishable from the background

Following damage to the front end of the vehicle, have the configuration and operation of the radar sensors checked at a qualified specialist workshop. This also applies to collisions at slow speeds where there is no visible damage to the front of the vehicle.

Following damage to the windshield, have the configuration and operation of the camera system checked at a qualified specialist workshop.

Function

To avoid a collision, BAS PLUS calculates the brake force necessary if:

- you approach an obstacle, and
- BAS PLUS has detected a risk of collision

When driving at a speed under 20 mph

(30 km/h): if you depress the brake pedal, BAS PLUS is activated. The increase in brake pressure will be carried out at the last possible moment.

When driving at a speed above 20 mph

(30 km/h): if you depress the brake pedal sharply, BAS PLUS automatically raises the brake pressure to a value adapted to the traffic situation.

BAS PLUS provides braking assistance in hazardous situations with vehicles in front within a speed range between 4 mph (7 km/h) and 155 mph (250 km/h).

Up to a speed of approximately 44 mph (70 km/h), BAS PLUS may react to:

- stationary objects in the path of your vehicle, e.g. stopped or parked vehicles
- pedestrians in the path of your vehicle
- obstacles crossing your path, which move in the detection range of the sensors and are recognized by them

 If BAS PLUS demands particularly high braking force, preventative passenger protection

measures (PRE-SAFE®) are activated simultaneously.

- ▶ Keep the brake pedal depressed until the emergency braking situation is over. ABS prevents the wheels from locking.

BAS PLUS is deactivated and the brakes function as usual, if:

- you release the brake pedal.
- there is no longer a risk of collision.
- no obstacle is detected in front of your vehicle.
- you depress the accelerator pedal.
- you activate kickdown.

COLLISION PREVENTION ASSIST PLUS

General information

- ❗ Observe the "Important safety notes" section (▷ page 62).

COLLISION PREVENTION ASSIST PLUS consists of a distance warning function with an autonomous braking function and adaptive Brake Assist.

COLLISION PREVENTION ASSIST PLUS can help you to minimize the risk of a front-end collision with a vehicle ahead or reduce the effects of such a collision.

If COLLISION PREVENTION ASSIST PLUS detects that there is a risk of a collision, you will be warned visually and acoustically. If you do not react to the visual and audible collision warning, autonomous braking can be initiated in critical situations. If you apply the brake yourself in a critical situation, the COLLISION PREVENTION ASSIST PLUS adaptive Brake Assist assists you.

Important safety notes

In particular, the detection of obstacles can be impaired if:

- there is dirt on the sensors or anything else covering the sensors
- there is snow or heavy rain
- there is interference by other radar sources
- there are strong radar reflections, for example in parking garages
- a narrow vehicle is traveling in front, e.g. a motorbike

- a vehicle is traveling in front on a different line
- new vehicles or after a service on the COLLISION PREVENTION ASSIST PLUS system

Observe the notes in the section on breaking-in (▷ page 121).

Following damage to the front end of the vehicle, have the configuration and operation of the radar sensor checked at a qualified specialist workshop. This also applies to collisions at slow speeds where there is no visible damage to the front of the vehicle.

Activating/deactivating

The COLLISION PREVENTION ASSIST PLUS is automatically active after switching on the ignition.

You can activate or deactivate COLLISION PREVENTION ASSIST PLUS in the on-board computer (▷ page 192). When deactivated, the distance warning function and the autonomous braking function are also deactivated.

If COLLISION PREVENTION ASSIST PLUS is deactivated, the  symbol appears in the assistance graphics display.

Distance warning function

General information

The distance warning function can help you to minimize the risk of a front-end collision with a vehicle ahead or reduce the effects of such a collision. If the distance warning function detects that there is a risk of a collision, you will be warned visually and acoustically.

Important safety notes

- ❗ Observe the "Important safety notes" section for driving safety systems (▷ page 62).

WARNING

The distance warning function does not react:

- to people or animals
- to oncoming vehicles
- to crossing traffic
- when cornering

Thus, the distance warning function cannot provide a warning in all critical situations. There is a risk of an accident.

Always pay careful attention to the traffic situation and be ready to brake.

WARNING

The distance warning function cannot always clearly identify objects and complex traffic situations.

In such cases, the distance warning function may:

- give an unnecessary warning
- not give a warning

There is a risk of an accident.

Always pay careful attention to the traffic situation and do not rely solely on the distance warning function.

Function

Starting at a speed of around 4 mph (7 km/h), the distance warning function warns you if you rapidly approach a vehicle in front. An intermittent warning tone will then sound, and the  distance warning lamp will light up in the instrument cluster.

- ▶ Brake immediately in order to increase the distance from the vehicle in front.

or

- ▶ Take evasive action, provided it is safe to do so.

Due to the nature of the system, particularly complicated but non-critical driving conditions may also cause the system to display a warning.

With the help of the radar sensor system, the distance warning function can detect obstacles that are in the path of your vehicle for an extended period of time.

Up to a speed of around 44 mph (70 km/h), the distance warning function can also react to stationary obstacles, such as stopped or parked vehicles.

Autonomous braking function

If the driver does not react to the distance warning signal in a critical situation, COLLISION PREVENTION ASSIST PLUS can assist with the autonomous braking function.

The autonomous braking function:

- gives the driver more time to react to critical driving situations
- can help the driver to avoid an accident or
- reduces the effects of an accident

The autonomous braking function is available in the following speed ranges:

- from 4 mph (7 km/h) to approx. 65 mph (105 km/h) for moving objects
- from 4 mph (7 km/h) to approx. 31 mph (50 km/h) for stationary objects

Due to the nature of the system, particularly complicated but non-critical driving conditions may also cause the Autonomous Braking Function to intervene.

If the autonomous braking function requires a particularly high braking force, preventative passenger protection measures (PRE-SAFE®) are activated simultaneously.

Adaptive Brake Assist

General information

-  Observe the "Important safety notes" section (▷ page 62).

With the help of adaptive Brake Assist, the distance warning signal can detect obstacles that are in the path of your vehicle for an extended period of time.

If adaptive Brake Assist detects a risk of collision with the vehicle in front, it calculates the braking force necessary to avoid a collision. If you apply the brakes forcefully, adaptive Brake Assist will automatically increase the braking force to a level suitable for the traffic conditions. Adaptive Brake Assist provides braking assistance in hazardous situations at speeds above 4 mph (7 km/h). It uses radar sensor technology to assess the traffic situation.

Up to a speed of approximately 155 mph (250 km/h), adaptive Brake Assist is capable of reacting to moving objects that have already been detected as such at least once over the period of observation.

Up to a speed of approximately 44 mph (70 km/h), adaptive Brake Assist reacts to stationary obstacles.

If adaptive Brake Assist demands particularly high braking force, preventative passenger protection measures (PRE-SAFE®) are activated simultaneously (▷ page 55).

- ▶ Keep the brake pedal depressed until the emergency braking situation is over. ABS prevents the wheels from locking.

The brakes will work normally again if:

- you release the brake pedal.
- there is no longer any danger of a collision.
- no obstacle is detected in front of your vehicle.

Adaptive Brake Assist is then deactivated.

Important safety notes

- i** Observe the "Important safety notes" section for driving safety systems (▷ page 62).

WARNING

Adaptive Brake Assist cannot always clearly identify objects and complex traffic situations.

In such cases, Adaptive Brake Assist can:

- intervene unnecessarily
- not intervene

There is a risk of an accident.

Always pay careful attention to the traffic situation and be ready to brake. Terminate the intervention in a non-critical driving situation.

WARNING

Adaptive Brake Assist does not react:

- to people or animals
- to oncoming vehicles
- to crossing traffic
- when cornering

As a result, the Adaptive Brake Assist may not intervene in all critical conditions. There is a risk of an accident.

Always pay careful attention to the traffic situation and be ready to brake.

Due to the nature of the system, particularly complicated but non-critical driving conditions may also cause Brake Assist to intervene.

If adaptive Brake Assist is not available due to a malfunction in the radar sensor system, the brake system remains available with full brake boosting effect and BAS.

ESP® (Electronic Stability Program)

General notes

- i** Observe the "Important safety notes" section (▷ page 62).

ESP® monitors driving stability and traction, i.e. power transmission between the tires and the road surface.

If ESP® detects that the vehicle is deviating from the direction desired by the driver, one or more wheels are braked to stabilize the vehicle. The engine output is also modified to keep the vehicle on the desired course within physical limits. ESP® assists the driver when pulling away on wet or slippery roads. ESP® can also stabilize the vehicle during braking.

ETS/4ETS (Electronic Traction System)

ETS traction control is part of ESP®. On vehicles with 4MATIC, 4ETS is part of ESP®.

Traction control brakes the drive wheels individually if they spin. This enables you to pull away and accelerate on slippery surfaces, for example if the road surface is slippery on one side. In addition, more drive torque is transferred to the wheel or wheels with traction.

Traction control remains active, even if you deactivate ESP®.

Important safety notes

- i** Observe the "Important safety notes" section (▷ page 62).

WARNING



If ESP® is malfunctioning, ESP® is unable to stabilize the vehicle. Additionally, further driving safety systems are deactivated. This increases the risk of skidding and an accident.

Drive on carefully. Have ESP® checked at a qualified specialist workshop.

- !** Vehicles with 4MATIC: function or performance tests may only be carried out on a 2-axle dynamometer. Before you operate the vehicle on such a dynamometer, please consult a qualified workshop. You could otherwise damage the drive train or the brake system.

Vehicles without 4MATIC: observe the notes on ESP® (▷ page 278) when towing the vehicle with a raised rear axle.

If the  ESP® OFF warning lamp lights up continuously, then ESP® is deactivated.

If the  ESP® warning lamp and the  ESP® OFF warning lamp are lit continuously, ESP® is not available due to a malfunction.

Observe the information on warning lamps (▷ page 222) and display messages which may be shown in the instrument cluster (▷ page 198).

i Only use wheels with the recommended tire sizes. Only then will ESP® function properly.

Characteristics of ESP®

General information

If the  ESP warning lamp goes out before beginning the journey, ESP® is automatically active.

If ESP® intervenes, the  ESP® warning lamp flashes in the instrument cluster.

If ESP® intervenes:

- ▶ Do not deactivate ESP® under any circumstances.
- ▶ Only depress the accelerator pedal as far as necessary when pulling away.
- ▶ Adapt your driving style to suit the prevailing road and weather conditions.

ECO start/stop function

The ECO start/stop function switches the engine off automatically when the vehicle stops moving. The engine starts automatically when the driver wants to pull away again. ESP® remains in its previously selected status. **Example:** if ESP® was deactivated before the engine was switched off, ESP® remains deactivated when the engine is switched on again.

Deactivating/activating ESP®

Important safety notes

You can select between the following states of ESP®:

- ESP® is activated.
- ESP® is deactivated.

WARNING

If you deactivate ESP®, ESP® no longer stabilizes the vehicle. There is an increased risk of skidding and an accident.

Only deactivate ESP® in the situations described in the following.

It may be best to deactivate ESP® in the following situations:

- when using snow chains
- in deep snow
- on sand or gravel

i Activate ESP® as soon as the situations described above no longer apply. ESP® will otherwise not be able to stabilize the vehicle if the vehicle starts to skid or a wheel starts to spin.

! Avoid spinning the driven wheels for an extended period with ESP® deactivated. You could otherwise damage the drivetrain.

Deactivating/activating ESP®

You can deactivate or activate ESP® via the on-board computer (▷ page 191).

ESP® deactivated:

The  ESP® OFF warning lamp in the instrument cluster lights up.

ESP® activated:

The  ESP® OFF warning lamp in the instrument cluster goes out.

Characteristics when ESP® is deactivated

If ESP® is deactivated and one or more wheels start to spin, the  ESP® warning lamp in the instrument cluster flashes. In such situations, ESP® will not stabilize the vehicle.

If you deactivate ESP®:

- ESP® no longer improves driving stability.
- Engine torque is no longer limited and the drive wheels are able to spin.

The spinning of the wheels results in a cutting action for better traction on loose surfaces.

- Traction control is still activated.
- COLLISION PREVENTION ASSIST is no longer available; nor is it activated if you brake firmly with assistance from ESP®.

- PRE-SAFE® is no longer available, nor is it activated if you brake firmly and ESP® intervenes.
- PRE-SAFE® Brake is no longer available, it is also not activated if you brake firmly and ESP® intervenes.
- ESP® still provides support when you brake firmly.

ESP® trailer stabilization

General information

If your vehicle/trailer combination begins to swerve, ESP® assists you in this situation. ESP® slows the vehicle down by braking and limiting the engine output until the vehicle/trailer combination has stabilized.

Important safety notes

WARNING

If road and weather conditions are poor, trailer stabilization will not be able to prevent the vehicle/trailer combination from swerving. Trailers with a high center of gravity can tip over before ESP® can detect this. There is a risk of an accident.

Always adapt your driving style to the prevailing road and weather conditions.

If your vehicle with trailer (vehicle/trailer combination) begins to lurch, you can only stabilize the vehicle/trailer combination by depressing the brake firmly.

ESP® trailer stabilization is active above speeds of about 65 km/h.

ESP® trailer stabilization does not work if ESP® is deactivated or disabled because of a malfunction.

EBD (electronic brake force distribution)

General information

EBD monitors and controls the brake pressure on the rear wheels to improve driving stability while braking.

Important safety notes

-  Observe the "Important safety notes" section for driving safety systems (> page 62).

WARNING

If EBD is malfunctioning, the rear wheels can lock, e.g. under full braking. This increases the risk of skidding and an accident.

You should therefore adapt your driving style to the different handling characteristics. Have the brake system checked at a qualified specialist workshop.

Observe information regarding indicator and warning lamps (> page 222) as well as display messages (> page 199).

ADAPTIVE BRAKE

-  Observe the "Important safety notes" section (> page 62).

ADAPTIVE BRAKE enhances braking safety and offers increased braking comfort. In addition to the braking function, ADAPTIVE BRAKE also has the HOLD function (> page 156) and hill start assist (> page 124).

PRE-SAFE® Brake

General information

PRE-SAFE® Brake can help you to minimize the risk of a collision with a vehicle ahead or a pedestrian, and reduce the effects of such a collision. If PRE-SAFE® Brake has detected a risk of collision, you will be warned visually and acoustically as well as by automatic braking.

-  Pay attention to the important safety notes in the "Driving safety systems" section (> page 62).

PRE-SAFE® Brake is only available in vehicles with the Driving Assistance Plus package.

For PRE-SAFE® Brake to assist you when driving, the radar sensor system and the camera system must be switched on and be operational.

With the help of the radar sensor system and the camera system, PRE-SAFE® Brake can detect obstacles that are in front of your vehicle for an extended period of time.

In addition, pedestrians in the path of your vehicle can be detected.

PRE-SAFE® Brake detects pedestrians using typical characteristics such as the body contours and posture of a person standing upright.

- i** Observe the restrictions described in the "Important safety notes" section (▷ page 70).

Important safety notes

WARNING

PRE-SAFE® Brake will initially brake your vehicle by a partial application of the brakes if a danger of collision is detected. There may be a collision unless you brake yourself. Even after subsequent full application of the brakes a collision cannot always be avoided, particularly when approaching at too high a speed. There is a risk of an accident.

Always apply the brakes yourself and try to take evasive action, provided it is safe to do so.

In the event of a partial application of the brakes, the vehicle is braked with up to 50% of the full braking pressure.

WARNING

PRE-SAFE® Brake cannot always clearly identify objects and complex traffic conditions.

In these cases, PRE-SAFE® Brake may:

- give an unnecessary warning and then brake the vehicle
- not give a warning or intervene

There is a risk of an accident.

Always pay particular attention to the traffic situation and be ready to brake, especially if PRE-SAFE® Brake warns you. Terminate the intervention in a non-critical driving situation.

WARNING

PRE-SAFE® Brake cannot always clearly identify people, especially if they are moving. In these cases, PRE-SAFE® Brake cannot intervene. There is a risk of an accident.

Always pay particular attention to the traffic situation and be ready to brake, especially if PRE-SAFE® Brake warns you.

In order to maintain the appropriate distance to the vehicle in front and thus prevent a collision, you must apply the brakes yourself.

WARNING

PRE-SAFE® Brake does not react:

- to small people, e.g. children
- to animals
- to oncoming vehicles
- to crossing traffic
- when cornering

As a result, PRE-SAFE® Brake may neither give warnings nor intervene in all critical situations. There is a risk of an accident.

Always pay careful attention to the traffic situation and be ready to brake.

In the event of snowfall or heavy rain, the recognition can be impaired.

Recognition by the radar sensor system is also impaired if:

- there is dirt on the sensors or anything else covering the sensors
- there is interference by other radar sources
- there are strong radar reflections, for example in parking garages
- a narrow vehicle is traveling in front, e.g. a motorbike
- a vehicle is traveling in front on a different line relative to the center of your vehicle

Recognition by the camera system is also impaired in the event of:

- dirt on the camera or if the camera is covered
- glare on the camera system, e.g. from the sun being low in the sky

- darkness
- or if:
 - pedestrians move quickly, e.g. into the path of the vehicle
 - the camera system no longer recognizes a pedestrian as a person due to special clothing or other objects
 - a pedestrian is concealed by other objects
 - the typical outline of a person is not distinguishable from the background

Following damage to the front end of the vehicle, have the configuration and operation of the radar sensors checked at a qualified specialist workshop. This also applies to collisions at slow speeds where there is no visible damage to the front of the vehicle.

Following damage to the windshield, have the configuration and operation of the camera system checked at a qualified specialist workshop.

Function

- ▶ **To activate/deactivate:** activate or deactivate PRE-SAFE® Brake in the on-board computer (▷ page 192).

If the PRE-SAFE® Brake is not activated, the  symbol appears in the multifunction display.

Starting at a speed of around 4 mph (7 km/h), this function warns you if you rapidly approach a vehicle in front. An intermittent warning tone will then sound and the  distance warning lamp will light up in the instrument cluster.

- ▶ Brake immediately to defuse the situation.
- or
- ▶ Take evasive action provided it is safe to do so.

PRE-SAFE® Brake can also brake the vehicle automatically under the following conditions:

- the driver and front-passenger have their seat belts fastened and
- the vehicle speed is between approximately 4 mph (7 km/h) and 124 mph (200 km/h)

At speeds of up to approximately 44 mph (70 km/h) PRE-SAFE® Brake can also detect:

- stationary objects in the path of your vehicle, e.g. stopped or parked vehicles
- pedestrians in the path of your vehicle

- ❗ If there is an increased risk of a collision, preventive passenger protection measures (PRE-SAFE®) are triggered (▷ page 55).

If the risk of collision with the vehicle in front remains and you do not brake, take evasive action or accelerate significantly, the vehicle may perform automatic emergency braking, up to the point of full brake application. Automatic emergency braking is not performed until immediately prior to an imminent accident.

You can prevent the intervention of the PRE-SAFE® Brake at any time by:

- depressing the accelerator pedal further.
- activating kickdown.
- releasing the brake pedal.

The braking action of PRE-SAFE® Brake is ended automatically if:

- you maneuver to avoid the obstacle.
- there is no longer a risk of collision.
- there is no longer an obstacle detected in front of your vehicle.

STEER CONTROL

General information

STEER CONTROL helps you by transmitting a noticeable steering force to the steering wheel in the direction required for vehicle stabilization. This steering assistance is provided in particular if:

- ESP® is deactivated
- both right wheels or both left wheels are on a slippery road surface when you brake heavily
- the vehicle starts to skid

Important safety notes

- ❗ Observe the "Important safety notes" section (▷ page 62).

No steering support is provided by STEER CONTROL, if:

- ESP® is malfunctioning.
- the lighting is faulty.

Power steering will, however, continue to function.

Protection against theft

Immobilizer

The immobilizer prevents your vehicle from being started without the correct SmartKey.

- ▶ **To activate with the SmartKey:** remove the SmartKey from the ignition lock.
- ▶ **To activate with KEYLESS-GO:** switch the ignition off and open the driver's door.
- ▶ **To deactivate:** switch on the ignition.

When leaving the vehicle, always take the SmartKey with you and lock the vehicle. Anyone can start the engine if a valid SmartKey has been left inside the vehicle.

i The immobilizer is always deactivated when you start the engine.

In the event that the engine cannot be started (yet the vehicle's battery is charged), the system is not operational. Contact an authorized Mercedes-Benz Center or call 1-800-FOR-MERCEdes (in the USA) or 1-800-387-0100 (in Canada).

ATA (anti-theft alarm system)



- ▶ **To arm:** lock the vehicle with the SmartKey or KEYLESS-GO.

Indicator lamp ① flashes. The alarm system is armed after approximately 15 seconds.

- ▶ **To deactivate:** unlock the vehicle with the SmartKey or KEYLESS-GO.



or

- ▶ Insert the SmartKey into the ignition lock.

A visual and audible alarm is triggered if the alarm system is armed and you open:

- a door
- the vehicle with the mechanical key

- the trunk lid
- the hood

- ▶ **To switch the alarm off with the SmartKey:** press the  or  button on the SmartKey.

The alarm is switched off.

or

- ▶ Remove the Start/Stop button from the ignition lock.

- ▶ Insert the SmartKey into the ignition lock. The alarm is switched off.

- ▶ **To stop the alarm using KEYLESS-GO:** grasp the outside door handle. The SmartKey must be outside the vehicle.

The alarm is switched off.

or

- ▶ Press the Start/Stop button on the dashboard. The SmartKey must be inside the vehicle.

The alarm is switched off.

The alarm is not switched off, even if you close the open door that triggered it, for example.

- i** If the alarm continues for more than 30 seconds, the mbrace emergency call system automatically notifies the Customer Assistance Center. This is done either by text message or data connection.

The emergency call system sends the message or data provided that:

- you have subscribed to the mbrace service.
- the mbrace service has been activated properly.
- the necessary mobile phone network is available.

SmartKey

Important safety notes

WARNING

If children are left unsupervised in the vehicle, they could:

- open the doors, thus endangering other people or road users.
- get out and disrupt traffic.
- operate the vehicle's equipment.

Additionally, children could set the vehicle in motion if, for example, they:

- release the parking brake.
- shifting the automatic transmission out of park position **P**
- Start the engine.

There is a risk of an accident and injury.

When leaving the vehicle, always take the SmartKey with you and lock the vehicle. Never leave children or animals unattended in the vehicle. Always keep the SmartKey out of reach of children.

WARNING

If you attach heavy or large objects to the SmartKey, the SmartKey could be unintentionally turned in the ignition lock. This could cause the engine to be switched off. There is a risk of an accident.

Do not attach any heavy or large objects to the SmartKey. Remove any bulky key rings before inserting the SmartKey into the ignition lock.

- I** Keep the SmartKey away from strong magnetic fields. Otherwise, the remote control function could be affected.

Strong magnetic fields can occur in the vicinity of powerful electrical installations.



Do not keep the SmartKey:

- with electronic devices, e.g. a mobile phone or another SmartKey.
- with metallic objects, e.g. coins or metal foil.
- inside metallic objects, e.g. a metal case.

This can affect the functionality of the SmartKey.

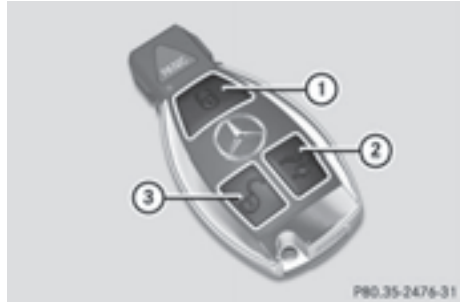
SmartKey functions



- ①  To lock the vehicle
- ②  To unlock the trunk lid
- ③  To unlock the vehicle

► **To unlock centrally:** press the  button.

If you do not open the vehicle within approximately 40 seconds of unlocking:

- the vehicle is locked again.
- anti-theft protection is reactivated.

► **To lock centrally:** press the  button.

The SmartKey centrally locks/unlocks:

- the doors
- the trunk lid
- the fuel filler flap

The turn signals flash once when unlocking and three times when locking.

You can also set an audible signal to confirm that the vehicle has been locked. The audible signal can be activated and deactivated using the on-board computer (▷ page 195).

When it is dark, the surround lighting also comes on if it is activated in the on-board computer (▷ page 194).

KEYLESS-GO

General notes

Bear in mind that the engine can be started by any of the vehicle occupants if there is a KEYLESS-GO key in the vehicle (▷ page 124).

Locking/unlocking centrally

You can start, lock or unlock the vehicle using KEYLESS-GO. To do this, you only need carry the SmartKey with you. You can combine the func-

tions of KEYLESS-GO with those of a conventional SmartKey. Unlock the vehicle by using KEYLESS-GO, for instance, and lock it using the  button on the SmartKey.

When locking or unlocking with KEYLESS-GO, the distance between the SmartKey and the corresponding door handle must not be greater than 3 ft (1 m).

A check which periodically establishes a radio connection between the vehicle and the SmartKey determines whether a valid SmartKey is in the vehicle. This occurs, for example:

- when the external door handles are touched
- when starting the engine
- while the vehicle is in motion



- ▶ **To unlock the vehicle:** touch the inner surface of the door handle.
- ▶ **To lock the vehicle:** touch sensor surface ①.
- ▶ **Convenience closing feature:** touch recessed sensor surface ② for an extended period.
Further information on the convenience closing feature (▷ page 84).



- ▶ **To unlock the trunk lid:** pull the handle on the trunk lid.
The vehicle only unlocks the trunk lid.

Deactivating and activating

If you do not intend to use a SmartKey for an extended period of time, you can deactivate the KEYLESS-GO function of the SmartKey. The SmartKey will then use very little power, thereby conserving battery power. For the purposes of activation/deactivation, the vehicle must not be nearby.



- ▶ **To deactivate:** press the  button on the SmartKey twice in rapid succession. The battery check lamp of the SmartKey (▷ page 76) flashes twice briefly and lights up once, then KEYLESS-GO is deactivated.
- ▶ **To activate:** press any button on the SmartKey.



or

- ▶ Insert the SmartKey into the ignition lock. KEYLESS-GO and all of its associated features are available again.

Changing the settings of the locking system

You can change the settings of the locking system. This means that only the driver's door and the fuel filler flap are unlocked when the vehicle is unlocked. This is useful if you frequently travel alone.

- ▶ **To change the setting:** simultaneously press the  and  buttons on the SmartKey for approximately six seconds until the battery check lamp flashes twice (▷ page 76).



If the setting of the locking system is changed within the signal range of the vehicle, pressing the  or  button:

- locks or
- unlocks the vehicle

The SmartKey now functions as follows:

- ▶ **To unlock:** press the  button once.
- ▶ **To unlock centrally:** press the  button twice.
- ▶ **To lock centrally:** press the  button.

The KEYLESS-GO function is changed as follows:

- ▶ **To unlock the driver's door:** touch the inner surface of the door handle on the driver's door.
- ▶ **To unlock centrally:** touch the inner surface of the front-passenger door handle.
- ▶ **To lock centrally:** touch the outer sensor surface on one of the door handles.
- ▶ **To restore the factory settings:** press and hold down the  and  buttons simultaneously for approximately six seconds until the battery check lamp flashes twice (▷ page 76).

Mechanical key

General notes

If the vehicle can no longer be locked or unlocked with the SmartKey, use the mechanical key.

If you use the mechanical key to unlock and open the driver's door or the trunk lid, the anti-theft alarm system will be triggered. Switch off the alarm (▷ page 72).

If you unlock the vehicle using the mechanical key, the fuel filler flap will not be unlocked automatically.

- ▶ **To unlock the fuel filler flap:** insert the SmartKey into the ignition lock.

Removing the mechanical key



- ▶ Push release catch ① in the direction of the arrow and at the same time remove mechanical key ② from the SmartKey.

For further information about:

- unlocking the driver's door (▷ page 80)
- unlocking the trunk (▷ page 81)
- locking the vehicle (▷ page 80)

Inserting the mechanical key

- ▶ Push mechanical key ② completely into the SmartKey until it engages and release catch ① is back in its basic position.

SmartKey battery

Important safety notes

WARNING

Batteries contain toxic and corrosive substances. If batteries are swallowed, it can result in severe health problems. There is a risk of fatal injury.

Keep batteries out of the reach of children. If a battery is swallowed, seek medical attention immediately.

Environmental note



Batteries contain dangerous substances. It is against the law to dispose of them with the household rubbish. They must be collected separately and recycled to protect the environment.





Dispose of batteries in an environmentally friendly manner. Take discharged batteries to a qualified specialist workshop or a special collection point for used batteries.

The SmartKey batteries contain perchlorate material, which may require special handling and regard for the environment. National guidelines must be observed during disposal. In California, see www.dtsc.ca.gov/HazardousWaste/Perchlorate/index.cfm.

Mercedes-Benz recommends that you have the batteries replaced at a qualified specialist workshop.



Checking the battery



- ▶ Press the  or  button. The battery is working properly if battery check lamp **1** lights up briefly.

The battery is discharged if battery check lamp **1** does not light up briefly.

- ▶ Change the battery (▷ page 76).

If the SmartKey battery is checked within the signal reception range of the vehicle, pressing the  or  button:

- locks or
- unlocks the vehicle

i You can get a battery at any qualified specialist workshop.

Replacing the battery

You require a CR 2025 3 V cell battery.

- ▶ Take the mechanical key out of the SmartKey (▷ page 75).



- ▶ Press mechanical key **2** into the SmartKey opening in the direction of the arrow until bat-

tery compartment cover **1** opens. Do not hold battery compartment cover **1** closed while doing so.

- ▶ Remove battery compartment cover **1**.

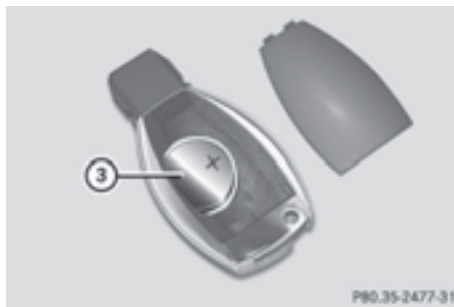

- ▶ Repeatedly tap the SmartKey against your palm until battery **3** falls out.
- ▶ Insert the new battery with the positive terminal facing upwards. Use a lint-free cloth to do so.
- ▶ Make sure that the surface of the battery is free of lint, grease and other contaminants.
- ▶ Insert the front tabs of battery compartment cover **1** into the housing and then press to close it.
- ▶ Insert mechanical key **2** into the SmartKey (▷ page 75).
- ▶ Check the function of all SmartKey buttons on the vehicle.

Problems with the SmartKey

| Problem | Possible causes/consequences and ► Solutions |
|---|---|
| <p>You can no longer lock or unlock the vehicle using the SmartKey.</p> | <p>The SmartKey battery is discharged or nearly discharged.</p> <ul style="list-style-type: none"> ► Check the SmartKey battery (▷ page 76) and replace it if necessary (▷ page 76). <p>If this does not work:</p> <ul style="list-style-type: none"> ► Unlock (▷ page 80) or lock (▷ page 80) the vehicle using the mechanical key. |
| | <p>There is interference from a powerful source of radio waves.</p> <ul style="list-style-type: none"> ► Unlock (▷ page 80) or lock (▷ page 80) the vehicle using the mechanical key. |
| | <p>The SmartKey is faulty.</p> <ul style="list-style-type: none"> ► Unlock (▷ page 80) or lock (▷ page 80) the vehicle using the mechanical key. ► Have the SmartKey checked at a qualified specialist workshop. |
| <p>You can no longer lock or unlock the vehicle using KEYLESS-GO.</p> | <p>KEYLESS-GO was deactivated.</p> <ul style="list-style-type: none"> ► Reactivate KEYLESS-GO (▷ page 73). |
| | <p>The SmartKey battery is discharged or nearly discharged.</p> <ul style="list-style-type: none"> ► Check the SmartKey battery (▷ page 76) and replace it if necessary (▷ page 76). <p>If this does not work:</p> <ul style="list-style-type: none"> ► Unlock (▷ page 80) or lock (▷ page 80) the vehicle using the mechanical key. |
| | <p>There is interference from a powerful source of radio waves.</p> <ul style="list-style-type: none"> ► Unlock (▷ page 80) or lock (▷ page 80) the vehicle using the mechanical key. |
| | <p>KEYLESS-GO is malfunctioning.</p> <ul style="list-style-type: none"> ► Lock/unlock the vehicle using the remote control function of the SmartKey. ► Have the vehicle and SmartKey checked at a qualified specialist workshop. <p>If the vehicle can also not be locked/unlocked using the remote control function:</p> <ul style="list-style-type: none"> ► Unlock (▷ page 80) or lock (▷ page 80) the vehicle using the mechanical key. ► Have the vehicle and SmartKey checked at a qualified specialist workshop. |

| Problem | Possible causes/consequences and ► Solutions |
|--|---|
| The engine cannot be started using the SmartKey. | <p>The on-board voltage is too low.</p> <ul style="list-style-type: none"> ► Switch off non-essential consumers, e.g. seat heating or interior lighting, and try to start the engine again. <p>If this does not work:</p> <ul style="list-style-type: none"> ► Check the starter battery and charge it if necessary (> page 272). or ► Jump-start the vehicle (> page 274). or ► Consult a qualified specialist workshop. |
| The engine cannot be started using KEYLESS-GO. The SmartKey is in the vehicle. | <p>The vehicle is locked.</p> <ul style="list-style-type: none"> ► Unlock the vehicle and try to start the vehicle again. <p>There is interference from a powerful source of radio waves.</p> <ul style="list-style-type: none"> ► Start your vehicle with the SmartKey in the ignition lock. |
| You have lost a SmartKey. | <ul style="list-style-type: none"> ► Have the SmartKey deactivated at a qualified specialist workshop. ► Report the loss immediately to the vehicle insurers. ► If necessary, have the locks changed as well. |
| You have lost the mechanical key. | <ul style="list-style-type: none"> ► Report the loss immediately to the vehicle insurers. ► If necessary, have the locks changed as well. |

Doors

Important safety notes

WARNING

If children are left unsupervised in the vehicle, they could:

- open the doors, thus endangering other people or road users.
- get out and disrupt traffic.
- operate the vehicle's equipment.

Additionally, children could set the vehicle in motion if, for example, they:

- release the parking brake.
- shifting the automatic transmission out of park position **P**
- Start the engine.

There is a risk of an accident and injury.

When leaving the vehicle, always take the SmartKey with you and lock the vehicle. Never

leave children or animals unattended in the vehicle. Always keep the SmartKey out of reach of children.

Unlocking and opening doors from the inside

- !** The side windows will not open/close if the battery is discharged or if the side windows have iced up. It will then not be possible to close the door. Do not attempt to force the door closed. You could otherwise damage the door or the side window.

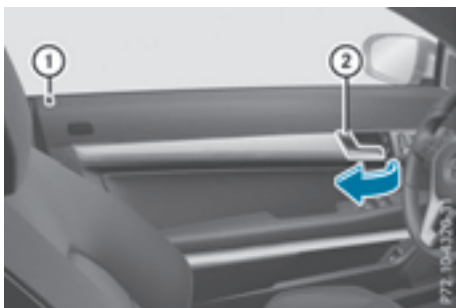

- ▶ **To unlock a front door:** pull door handle ②. Locking knob ① pops up. The door is unlocked and can be opened.
- ▶ **To open a front door:** pull door handle ②.
- ▶ **To unlock a rear door:** pull up locking knob ①. The door is unlocked and can be opened.
- ▶ **To open a rear door:** pull door handle ②.

When a door is opened, the side window on that side opens slightly. When the door is closed, the side window closes again.

Centrally locking and unlocking the vehicle from the inside

You can centrally lock or unlock the vehicle from the inside. The switches are on the driver's door.



- ▶ **To unlock:** press button ①.
- ▶ **To lock:** press button ②. If all the doors are closed, the vehicle locks.

Meanwhile, the fuel filler flap will not be locked or unlocked.

If the vehicle has been locked from the outside, it cannot be centrally unlocked from the inside.

You can open a door from inside the vehicle even if it has been locked.

If a locked door is opened from the inside, the previous unlock status of the vehicle will be taken into consideration if:

- the vehicle was locked using the locking button for the central locking, or
- if the vehicle was locked automatically

The vehicle will be fully unlocked if it had previously been fully unlocked. If only the driver's door had been previously unlocked, only the door which has been opened from the inside is unlocked.

Automatic locking feature



- ▶ **To deactivate:** press and hold button ① for about five seconds until a tone sounds.
- ▶ **To activate:** press and hold button ② for about five seconds until a tone sounds.

If you press one of the two buttons and do not hear a tone, the relevant setting has already been selected.

The vehicle is locked automatically when the ignition is switched on and the wheels are turning.

You could therefore lock yourself out if:

- the vehicle is being pushed.
- the vehicle is being towed.
- the vehicle is on a roller dynamometer.

You can also switch the automatic locking function on and off using the on-board computer (▷ page 195).

Unlocking/locking the driver's door using the mechanical key

- i** If you want to centrally lock the vehicle using the mechanical key, begin by pressing the locking button for the interior locking mechanism while the driver's door is open. Then lock the driver's door using the mechanical key.



- ▶ **To unlock:** turn the mechanical key counter-clockwise as far as it will go to position **1**.
- ▶ **To lock:** turn the mechanical key clockwise as far as it will go to position **1**.

If you use the mechanical key to unlock and open the driver's door, the anti-theft alarm system will be triggered. Switch off the alarm (> page 72).

Trunk

Important safety notes

WARNING

Combustion engines emit poisonous exhaust gases such as carbon monoxide. Exhaust gases can enter the vehicle interior if the trunk lid is open when the engine is running, especially if the vehicle is in motion. There is a risk of poisoning.

Always switch off the engine before opening the trunk lid. Never drive with the trunk lid open.

- !** The trunk lid swings upwards when opened. Therefore, make sure that there is sufficient clearance above the trunk lid.

The opening dimensions of the trunk lid can be found in the "Vehicle data" section (> page 313).

You should preferably place luggage or loads in the trunk. Observe the loading guidelines (> page 235).

Do not leave the SmartKey in the trunk. You could otherwise lock yourself out.

The trunk lid can be:

- opened and closed manually from outside
- opened automatically from inside
- locked separately
- opened with the emergency release button
- unlocked with the mechanical key

Opening/closing from outside

Opening



- ▶ Press the  button on the SmartKey .
- ▶ Pull handle **1**.
- ▶ Raise the trunk lid.

Closing



- ▶ Pull the trunk lid down using recess ①.
- ▶ If necessary, lock the vehicle with the  button on the SmartKey (> page 73) or with KEYLESS-GO (> page 73).

If a KEYLESS-GO key is detected in the trunk, the trunk lid cannot be locked and will open again.

Opening automatically from inside

Important safety notes

WARNING

Combustion engines emit poisonous exhaust gases such as carbon monoxide. Exhaust gases can enter the vehicle interior if the trunk lid is open when the engine is running, especially if the vehicle is in motion. There is a risk of poisoning.

Always switch off the engine before opening the trunk lid. Never drive with the trunk lid open.

Opening



- ▶ Pull remote operating switch for trunk lid ① until the trunk lid opens.

You can open the trunk lid from the driver's seat when the vehicle is stationary and unlocked.

The opening dimensions of the trunk lid can be found in the "Vehicle data" section (> page 313).

Locking the trunk separately

You can lock the trunk separately. If you then unlock the vehicle centrally, the trunk remains locked and cannot be opened.

- ▶ Close the trunk lid.
- ▶ Take the mechanical key out of the SmartKey (> page 75).

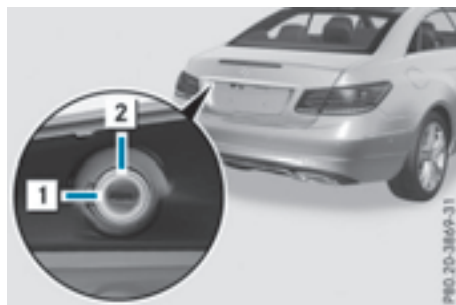

- ▶ Insert the mechanical key into the trunk lid lock as far as it will go.
- ▶ Turn the mechanical key clockwise from position ① to position ②.
- ▶ Remove the mechanical key.
- ▶ Insert the mechanical key into the SmartKey.

Unlocking the trunk (mechanical key)

- ! The trunk lid swings upwards when opened. Therefore, make sure that there is sufficient clearance above the trunk lid.

If the trunk cannot be unlocked with the SmartKey or KEYLESS-GO, use the mechanical key.

If you use the mechanical key to unlock and open the trunk lid, the anti-theft alarm system will be triggered. Switch off the alarm (> page 72).

- ▶ Take the mechanical key out of the SmartKey (> page 75).
- ▶ Insert the mechanical key into the trunk lid lock as far as it will go.

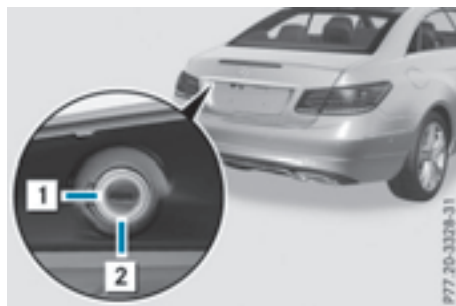

- ▶ Turn the mechanical key from position ① counter-clockwise as far as it will go to position ②. Simultaneously pull the trunk lid handle. The trunk is unlocked.
- ▶ Turn the mechanical key back to position ① and remove it.
- ▶ Insert the mechanical key into the SmartKey (> page 75).

Trunk emergency release

You can open the trunk lid from inside the vehicle with the emergency release button.

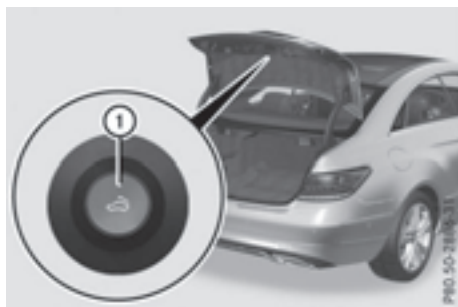

- ▶ Press emergency release button ① briefly. The trunk lid unlocks and opens.

The trunk lid can be unlocked and opened with the trunk lid emergency release when the vehicle is stationary or while driving.

The trunk lid emergency release does not open the trunk lid if the battery is disconnected or discharged.

Trunk lid emergency release light:

- Emergency release button ① flashes for 30 minutes after the trunk lid is opened.
- Emergency release button ① flashes for 60 minutes after the trunk lid is closed.

Side windows

Important safety notes

WARNING

While opening the side windows, body parts could become trapped between the side window and the door frame as the side window moves. There is a risk of injury.

Make sure that nobody touches the side window during the opening procedure. If somebody becomes trapped, release the switch or pull the switch to close the side window again.

WARNING

While closing the side windows, body parts in the closing area could become trapped. There is a risk of injury.

When closing make sure that no parts of the body are in the closing area. If somebody becomes trapped, release the switch or press the switch to open the side window again.

WARNING

If children operate the side windows they could become trapped, particularly if they are left unsupervised. There is a risk of injury.

Activate the override feature for the rear side windows. When leaving the vehicle, always take the SmartKey with you and lock the vehicle. Never leave children unsupervised in the vehicle.

Side window reversing feature

The side windows are equipped with an automatic reversing feature. If a solid object blocks or restricts a side window during the closing process, the side window opens again automatically. However, the automatic reversing feature is only an aid and is not a substitute for your attentiveness when closing a side window.

WARNING

The reversing feature does not react:

- to soft, light and thin objects, e.g. small fingers
- over the last 1/6 in(4 mm) of the closing movement
- during resetting
- when closing the side window again manually immediately after automatic reversing

This means that the reversing feature cannot prevent someone being trapped in these situations. There is a risk of injury.

Make sure that no body parts are in close proximity during the closing procedure. If someone becomes trapped, press the switch to open the side window again.

Opening and closing the side windows

The switches for all side windows are located on the driver's door. There is also a switch on the front-passenger door as well as on the doors in the rear compartment on the left and right-hand sides for the respective side window.

The switches on the driver's door take precedence.



- ① Front left
- ② Front right
- ③ Rear right
- ④ Rear left

- ▶ Turn the SmartKey to position **1** or **2** in the ignition lock.
- ▶ **To open manually:** press and hold the corresponding switch.
- ▶ **To open fully:** press the switch beyond the point of resistance and release it. Automatic operation is started.
- ▶ **To close manually:** pull and hold the corresponding switch.
- ▶ **To close fully:** pull the corresponding switch beyond the pressure point. Automatic operation is started.
- ▶ **To interrupt automatic operation:** press/pull the corresponding switch again.

You can start automatic operation when opening and closing the front door windows and when opening the rear door windows. To do so, briefly press or pull the switch to beyond the

point of resistance in the relevant direction. You can stop automatic operation by pressing or pulling again.

You can continue to operate the side windows after you switch off the engine or remove the SmartKey. This function is available for up to five minutes or until the driver's or front-passenger door is opened.

When the override feature for the side windows is activated, the side windows cannot be operated from the rear (> page 61).

Convenience opening

General notes



You can ventilate the vehicle before you start driving. To do this, the SmartKey is used to carry out the following functions simultaneously:

- unlock the vehicle
- open the side windows
- open the panorama roof with power tilt/sliding panel and the roller sunblind
- switch on the seat ventilation for the driver's seat

The convenience opening feature can only be operated using the SmartKey. The SmartKey must be in close proximity to the vehicle.

The "convenience opening" feature is also available when the vehicle is unlocked.

Convenience opening

- ▶ Press and hold the  button until the side windows and the panorama roof with power tilt/sliding panel are in the desired position. If the roller sunblind of the panorama roof with power tilt/sliding panel is closed, the roller sunblind is opened first.
- ▶ Press and hold the  button again until the panorama roof with power tilt/sliding panel is in the desired position.
- ▶ **To interrupt convenience opening:** release the  button.

Convenience closing feature

Important safety notes

Information on the side window reversing feature (▷ page 82).



WARNING

When the convenience closing feature is operating, parts of the body could become trapped in the closing area of the side window and the sliding sunroof. There is a risk of injury.

Observe the complete closing procedure when the convenience closing feature is operating. Make sure that no body parts are in close proximity during the closing procedure.

Proceed as follows if someone is trapped:

With the SmartKey:

- ▶ Release the  button.
- ▶ Press and hold the  button until the side windows and the sliding sunroof or the panorama roof with power tilt/sliding panel open again.

With KEYLESS-GO:

- ▶ Release the sensor surface on the door handle.
- ▶ Pull the door handle immediately and hold it. The side windows and the sliding sunroof or the panorama roof with power tilt/sliding panel open.

General notes

When you lock the vehicle, you can simultaneously:

- close the side windows
- close the panorama roof with power tilt/sliding panel



On vehicles with a panorama roof with power tilt/sliding panel, you can then close the roller sunblind.

Using the SmartKey

- ▶ **Vehicles without KEYLESS-GO:** point the tip of the SmartKey at the door handle on the driver's door.
- ▶ **Vehicles with KEYLESS-GO:** the SmartKey must be in close proximity to the vehicle.

- ▶ Press and hold the  button until the side windows and the panorama roof with power tilt/sliding panel are fully closed.
- ▶ Make sure that all the side windows and the panorama roof with power tilt/sliding panel are closed.

On vehicles with a panorama roof with power tilt/sliding panel:

- ▶ Press and hold the  button again until the roller sunblind of the panorama roof with power tilt/sliding panel closes.
- ▶ **To interrupt convenience closing:** release the  button.

Using KEYLESS-GO

The driver's door and the door at which the handle is used, must both be closed. The SmartKey must be outside the vehicle. The gap between the SmartKey and the corresponding door handle should not be greater than 3 ft (1 m).



- ▶ Touch recessed sensor surface ① on the door handle until the side windows and the panorama roof with power tilt/sliding panel are fully closed.
- ▶ **i** Make sure you only touch recessed sensor surface ①.
- ▶ Make sure that all the side windows and the panorama roof with power tilt/sliding panel are closed.

On vehicles with a panorama roof with power tilt/sliding panel:

- ▶ Touch recessed sensor surface ① on the door handle again until the roller sunblind of the panorama roof with power tilt/sliding panel closes.

- ▶ **To interrupt convenience closing:** release recessed sensor surface ① on the door handle.

Resetting the side windows

If a side window can no longer be closed fully, you must reset it.

- ▶ Close all the doors.
- ▶ Turn the SmartKey to position **1** or **2** in the ignition lock.
- ▶ Pull the corresponding switch on the door control panel until the side window is completely closed (▷ page 83).
- ▶ Hold the switch for an additional second.

If the side window opens again slightly:

- ▶ Immediately pull the corresponding switch on the door control panel until the side window is completely closed (▷ page 83).
- ▶ Hold the switch for an additional second.
- ▶ If the respective side window remains closed after the button is released, then it has been set correctly. If this is not the case, repeat the steps above again.

Problems with the side windows

WARNING

If you close a side window again immediately after it has been blocked or reset, the side window closes with increased or maximum force. The reversing feature is then not active. Parts of the body could be trapped in the closing area in the process. This poses an increased risk of injury or even fatal injury.

Make sure that no parts of the body are in the closing area. To stop the closing process, release the switch or push the switch again to reopen the side window.

| Problem | Possible causes/consequences and ► Solutions |
|---|--|
| A side window cannot be closed because it is blocked by objects, e.g. leaves in the window guide. | <ul style="list-style-type: none"> ► Remove the objects. ► Close the side window. |
| A side window cannot be closed and you cannot see the cause. | <p>If a side window is obstructed during closing and reopens again slightly:</p> <ul style="list-style-type: none"> ► Immediately after the window blocks, pull the corresponding switch again until the side window has closed. The side window is closed with increased force. <p>If a side window is obstructed again during closing and reopens again slightly:</p> <ul style="list-style-type: none"> ► Immediately after the window blocks, pull the corresponding switch again until the side window has closed. The side window is closed without the automatic reversing feature. |

Sliding sunroof

Important safety notes

In the following section, the term "sliding sunroof" refers to the panorama roof with power tilt/sliding panel.

WARNING

While opening and closing the sliding sunroof, body parts in close proximity could become trapped. There is a risk of injury.

Make sure that no body parts are in close proximity during the opening and closing procedures.

If somebody becomes trapped:

- release the switch immediately, or
- during automatic operation, push the switch briefly in any direction

The opening or closing procedure will be stopped.

WARNING

If children operate the sliding sunroof they could become trapped, particularly if they are left unsupervised. There is a risk of injury.

When leaving the vehicle, always take the SmartKey with you and lock the vehicle. Never leave children unsupervised in the vehicle.

- ❗ Only open the sliding sunroof if it is free of snow and ice. Otherwise, malfunctions may occur.

Do not allow anything to protrude from the sliding sunroof. Otherwise, the seals could be damaged.

- ❗ The weather can change abruptly. It could start to rain or snow. Make sure that the slid-

ing sunroof is closed when you leave the vehicle. The vehicle electronics can be damaged if water enters the vehicle interior.

Resonance noises can occur in addition to the usual airflow noises when the sliding sunroof is open. They are caused by minor pressure fluctuations in the vehicle interior. Change the position of the sliding sunroof or open a side window slightly to reduce or eliminate these noises.

Reversing feature for the panorama roof with power tilt/sliding panel

In the following section, the term "sliding sunroof" refers to the panorama roof with power tilt/sliding panel.

The sliding sunroof is equipped with an automatic reversing feature. If a solid object blocks or restricts the sliding sunroof during the closing process, the sliding sunroof opens again automatically. However, the automatic reversing feature is only an aid and is not a substitute for your attentiveness when closing the sliding sunroof.

WARNING

The reversing feature does not react:

- to soft, light and thin objects, e.g. small fingers
- over the last 1/6 in (4 mm) of the closing movement
- during resetting
- when closing the sliding sunroof again manually immediately after automatic reversing

This means that the reversing feature cannot prevent someone being trapped in these situations. There is a risk of injury.

Make sure that no body parts are in close proximity during the closing procedure.

If somebody becomes trapped:

- release the switch immediately, or
- press the switch in any direction during the automatic closing process

The closing process is stopped.

Operating the panorama roof with power tilt/sliding panel



- ① To raise
- ② To open
- ③ To close/lower

The panorama roof with power tilt/sliding panel can only be operated when the roller sunblind is open.

- ▶ **To open and close:** turn the SmartKey to position 1 or 2 in the ignition lock.
- ▶ Press or pull the  switch in the corresponding direction.

If you press the  switch beyond the point of resistance, an automatic opening/closing process is started in the corresponding direction. You can stop automatic operation by pressing/pulling the switch again.

Operating the roller sunblind for the panorama roof with power tilt/sliding panel

Important safety notes

WARNING

Parts of the body could become trapped between the roller sunblind and frame or sliding sunroof during automatic opening or closing. There is a risk of injury.

When opening or closing, make sure that no body parts are in the sweep of the roller sunblind.

If somebody becomes trapped:

- release the switch immediately, or
- during automatic operation, push the switch briefly in any direction

The opening or closing procedure will be stopped.

The roller sunblind shields the vehicle interior from sunlight. The roller sunblind can only be opened and closed when the panorama roof with power tilt/sliding panel is closed.

Roller sunblind reversing feature

The roller sunblind is equipped with an automatic reversing feature. If a solid object blocks or restricts the roller sunblind during the closing process, the roller sunblind opens again automatically. The automatic reversing feature is only an aid and is not a substitute for your attentiveness to the roller sunblind while it is closing.

WARNING

The reversing feature does not react in particular to soft, light and thin objects, e.g. small fingers. This means that the reversing feature cannot prevent someone being trapped in these situations. There is a risk of injury.

When closing the roller sunblind, make sure that no body parts are in the sweep area.

If somebody becomes trapped:

- release the switch immediately, or
- press the switch in any direction during the automatic closing process

The closing process is stopped.

Opening and closing



- ① To raise
- ② To open
- ③ To close/lower

- ▶ Turn the SmartKey to position **1** or **2** in the ignition lock.
- ▶ Press or pull the  switch in the corresponding direction.

If you press or pull the  switch beyond the point of resistance, an automatic opening/closing process is started in the corresponding direction. You can stop automatic operation by pressing or pulling again.





Resetting the panorama roof with power tilt/sliding panel and roller sunblind

- ❗ If the panorama roof with power tilt/sliding panel and the roller sunblind cannot be fully opened or closed after resetting, contact a qualified specialist workshop.

Reset the panorama roof with power tilt/sliding panel and the roller sunblind if the panorama roof with power tilt/sliding panel or the roller sunblind does not move smoothly.

- ▶ Turn the SmartKey to position **1** or **2** in the ignition lock.



- ▶ Pull the  switch repeatedly to the point of resistance in the direction of arrow ① until the panorama roof with power tilt/sliding panel is fully closed.
- ▶ Keep the  switch pulled for an additional second.
- ▶ Pull the  switch repeatedly to the point of resistance in the direction of arrow ① until the roller sunblind is fully closed.
- ▶ Keep the  switch pulled for an additional second.
- ▶ Make sure that the panorama roof with power tilt/sliding panel and the roller sunblind can be fully opened again.
- ▶ If this is not the case, repeat the steps above.

Problems with the sliding sunroof

In the following section, the term "sliding sunroof" refers to the panorama roof with power tilt/sliding panel.

WARNING

If you close the sliding sunroof again immediately after it has been blocked or reset, the sliding sunroof closes with increased or maximum force. The reversing feature is then not active. Parts of the body could be trapped in the closing area in the process. This poses an increased risk of injury or even fatal injury.



Make sure that no parts of the body are in the closing area.

If somebody becomes trapped:

- release the switch immediately, or
- press the switch in any direction during the automatic closing process

The closing process is stopped.

! If the sliding sunroof still cannot be opened or closed as a result of a malfunction, contact a qualified specialist workshop.

| Problem | Possible causes/consequences and ► Solutions |
|--|---|
| The sliding sunroof cannot be closed and you cannot see the cause. | <p>If the sliding sunroof is obstructed during closing and reopens again slightly:</p> <ul style="list-style-type: none"> ► Immediately after the sliding sunroof blocks, pull the  switch in the overhead control panel down to the point of resistance and hold it until the sliding sunroof is closed. The sliding sunroof is closed with increased force. <p>If the sliding sunroof is obstructed again during closing and then reopens slightly:</p> <ul style="list-style-type: none"> ► Immediately after the sliding sunroof blocks, pull the  switch in the overhead control panel down to the point of resistance and hold it until the sliding sunroof is closed. The sliding sunroof is closed without the anti-entrapment feature. |

Correct driver's seat position

WARNING

You could lose control of your vehicle if you do the following while driving:

- adjust the driver's seat, head restraint, steering wheel or mirrors
- fasten the seat belt

There is a risk of an accident.

Adjust the driver's seat, head restraint, steering wheel and mirror and fasten your seat belt before starting the engine.



Observe the following when adjusting steering wheel ①, seat belt ② and driver's seat ③:

- you are as far away from the driver's air bag as possible.
- you are sitting in a normal upright position.
- your thighs are slightly supported by the seat cushion.
- your legs are not entirely stretched and you can depress the pedals properly.
- the back of your head is supported at eye level by the center of the head restraint.
- you can hold the steering wheel with your arms slightly bent.
- you can move your legs freely.

- you can see all the displays in the instrument cluster clearly.
- you should have a good overview of traffic conditions.
- the seat belt is pulled snugly against the body and is routed across the center of your shoulder and across your hips in the pelvic area.

Further related subjects:

- Electrical seat adjustment (▷ page 92)
- Adjusting the steering wheel (▷ page 96)
- Fastening the seat belt correctly (▷ page 43).
- Adjusting the rear-view mirror and exterior mirrors (▷ page 99).
- Storing the seat, steering wheel and exterior mirror settings using the memory function (▷ page 102).

Seats

Important safety notes

WARNING

Children could become trapped if they adjust the seats, particularly when unattended. There is a risk of injury.

When leaving the vehicle, always take the SmartKey with you and lock the vehicle. Never leave children unsupervised in the vehicle.

The seats can still be adjusted when there is no SmartKey in the ignition lock.

WARNING

If the head restraints are not installed or not adjusted correctly, they cannot provide protection as intended. There is an increased risk of injury in the head and neck area, e.g. in the event of an accident or when braking.

Always drive with the head restraints installed. Before driving off, make sure for every vehicle occupant that the center of the head restraint supports the back of the head at about eye level.

Observe the safety notes on "Air bags" (▷ page 45) and "Children in the Vehicle" (▷ page 56).

⚠ WARNING

You could lose control of your vehicle if you do the following while driving:

- adjust the driver's seat, head restraint, steering wheel or mirrors
- fasten the seat belt

There is a risk of an accident.

Adjust the driver's seat, head restraint, steering wheel and mirror and fasten your seat belt before starting the engine.

⚠ WARNING

If you adjust the seat height carelessly, you or other vehicle occupants could be trapped and thereby injured. Children in particular could accidentally press the electrical seat adjustment buttons and become trapped. There is a risk of injury.

While moving the seats, make sure that your hands or other body parts do not get under the lever assembly of the seat adjustment system.

⚠ WARNING

When you adjust a seat, you or other vehicle occupants could become trapped, e.g. on the seat guide rail. There is a risk of injury.

Make sure when adjusting a seat that no one has any body parts in the sweep of the seat.

! To avoid damage to the seats and the seat heating, observe the following information:

- keep liquids from spilling on the seats. If liquid is spilled on the seats, dry them as soon as possible.
- if the seat covers are damp or wet, do not switch on the seat heating. The seat heating should also not be used to dry the seats.
- clean the seat covers as recommended; see "Interior care".
- do not transport heavy loads on the seats. Do not place sharp objects on the seat cushions, e.g. knives, nails or tools. The seats should only be occupied by passengers, if possible.
- when the seat heating is in operation, do not cover the seats with insulating materi-

als, e.g. blankets, coats, bags, seat covers, child seats or booster seats.

! Make sure that there are no objects in the footwell under or behind the seats when moving the seats back. There is a risk that the seats and/or the objects could be damaged.

i The head restraints in the front seats are installed with the NECK-PRO system (> page 54). For this reason, it is not possible to remove the head restraints from the front seats.

For more information, contact a qualified specialist workshop.

i Further related subjects:

- Through-loading feature in the rear bench seat (folding the rear bench seat forwards) (> page 45)

Adjusting the seats

- ① Head restraint height
- ② Seat cushion angle
- ③ Seat height
- ④ Seat fore-and-aft adjustment
- ⑤ Backrest angle

i If PRE-SAFE® is activated and the front-passenger seat is in an unfavorable position, it is moved to a better position.

i You can store the seat settings using the memory function (> page 102).

i Vehicles with the through-loading feature: if you fold down a rear seat backrest, the respective front seat is moved forwards slightly if necessary. This prevents the seats from colliding.

Adjusting the head restraints

Important safety notes

WARNING

You could lose control of your vehicle if you do the following while driving:

- adjust the driver's seat, head restraint, steering wheel or mirrors
- fasten the seat belt

There is a risk of an accident.

Adjust the driver's seat, head restraint, steering wheel and mirror and fasten your seat belt before starting the engine.

WARNING

If the head restraints are not installed or not adjusted correctly, they cannot provide protection as intended. There is an increased risk of injury in the head and neck area, e.g. in the event of an accident or when braking.

Always drive with the head restraints installed. Before driving off, make sure for every vehicle occupant that the center of the head restraint supports the back of the head at about eye level.

Do not rotate the head restraints of the front and rear seats. Otherwise, you cannot adjust the height and angle of the head restraints to the correct position.

Using the fore-and-aft adjustment, adjust the head restraint so that it is as close as possible to your head.

Observe the important safety notes regarding the seats (▷ page 91).

Adjusting the head restraint height electrically



- ▶ Slide switch for head restraint height adjustment ① up or down in the direction of the arrow.

Folding the front seat backrests forward/back

Important safety notes

WARNING

If the backrest is not engaged, it could fold forwards during a braking maneuver or in the event of an accident, for example. The seat backrest will then push the vehicle occupant against the seat belt. The seat belt can no longer offer the intended level of protection and could even cause injuries. There is an increased risk of injury.

Before each journey, make sure that the backrest engages fully as described.

WARNING

You could lose control of your vehicle if you do the following while driving:

- adjust the driver's seat, steering wheel or mirrors
- fasten the seat belt

There is a risk of an accident.

Adjust the driver's seat, steering wheel or mirrors and fasten your seat belt before starting the engine.

WARNING

When you adjust a seat, you or other vehicle occupants could become trapped, e.g. on the seat guide rail. There is a risk of injury.

Make sure when adjusting a seat that no one has any body parts in the sweep of the seat.

Folding the seat backrest forward



The seat moves forwards if you have folded the backrest forwards and the seat is in the rear half of the range. This makes it easier for passengers to get into and out of the rear compartment. The head restraint is lowered simultaneously.

- ▶ Pull seat release handle ① forwards and fold the backrest forwards as far as it will go. The seat automatically moves to the foremost position and the head restraint is lowered.

Folding the seat backrest back

- ▶ Swing back the seat backrest. The seat moves automatically to the stored position.

Adjusting the multicontour seat



- ① To adjust the thigh cushion
- ② To adjust the backrest contour in the lumbar region
- ③ To adjust the backrest contour in the upper back region
- ④ To adjust the side bolsters of the seat backrest

You can adjust the contour of the front seat individually so as to provide optimum support for your back and sides.

- ▶ Turn the SmartKey to position 2 in the ignition lock (> page 122).

Adjusting the 4-way lumbar support

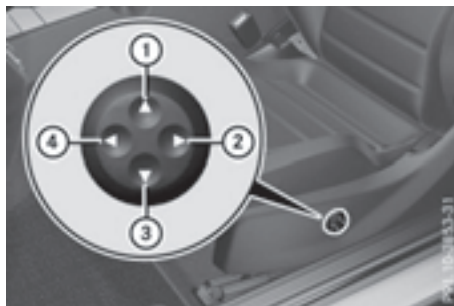

- ① To raise the backrest contour
- ② To soften the backrest contour
- ③ To lower the backrest contour
- ④ To harden the backrest contour

You can adjust the contour of the front seat backrests individually to provide optimum support for your back.

Seat heating and seat ventilation

Switching the seat heating on/off

WARNING

Repeatedly switching on the seat heating can cause the seat cushion and backrest pads to become very hot. The health of persons with limited temperature sensitivity or a limited ability to react to excessively high temperatures may be affected or they may even suffer burn-like injuries. There is a risk of injury.

Therefore, do not switch the seat heating on repeatedly.





Driver's and front-passenger seat

The three red indicator lamps in the button indicate the heating level you have selected.

The system automatically switches down from level **3** to level **2** after approximately eight minutes.

The system automatically switches down from level **2** to level **1** after approximately ten minutes.

The system automatically switches off approximately 20 minutes after it is set to level **1**.

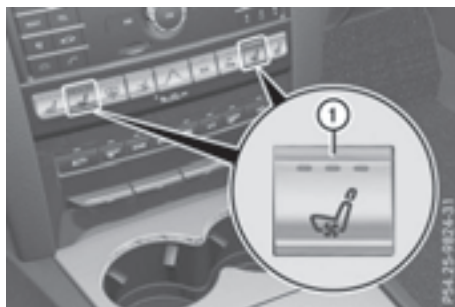

- ▶ Turn the SmartKey to position **1** or **2** in the ignition lock (▷ page 122).
- ▶ **To switch on:** press button  repeatedly until the desired heating level is set.
- ▶ **To switch off:** press button  repeatedly until all the indicator lamps go out.

Switching the seat ventilation on/off



Driver's and front-passenger seat

The three blue indicator lamps in the buttons indicate the ventilation level you have selected.

- ▶ Turn the SmartKey to position **1** or **2** in the ignition lock (▷ page 122).
- ▶ **To switch on:** press button  repeatedly until the desired ventilation level is set.
- ▶ **To switch off:** press button  repeatedly until all the indicator lamps go out.

 If the battery voltage is too low, the seat ventilation may switch off.

 You can open the side windows and the panorama roof with power tilt/sliding panel using the convenience opening feature (▷ page 83). The seat ventilation of the driver's seat automatically switches to the highest level.

Problems with the seat heating or seat ventilation

| Problem | Possible causes/consequences and ► Solutions |
|---|---|
| The seat heating or seat ventilation has switched off prematurely or cannot be switched on. | The on-board voltage is too low because too many electrical consumers are switched on. ► Switch off electrical consumers that you do not need, such as the rear window defroster or interior lighting. Once the battery is sufficiently charged, the seat heating or seat ventilation can be switched back on manually. |

Steering wheel

Important safety notes

⚠ WARNING

You could lose control of your vehicle if you do the following while driving:

- adjust the driver's seat, head restraint, steering wheel or mirrors
- fasten the seat belt

There is a risk of an accident.

Adjust the driver's seat, head restraint, steering wheel and mirror and fasten your seat belt before starting the engine.

⚠ WARNING

Children could injure themselves if they adjust the steering wheel. There is a risk of injury.

When leaving the vehicle, always take the SmartKey with you and lock the vehicle. Never leave children unsupervised in the vehicle.

The electrically adjustable steering wheel can still be adjusted when there is no SmartKey in the ignition lock.

Adjusting the steering wheel

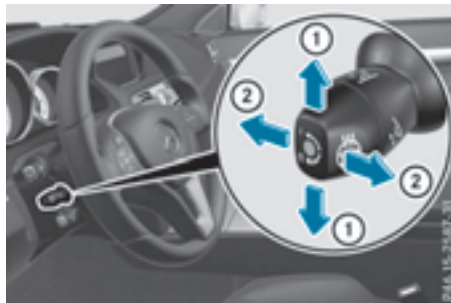

- ① To adjust the steering wheel height
- ② To adjust the steering wheel position (fore-and-aft adjustment)

i Further related subjects:

- EASY-ENTRY/EXIT feature (► page 98)
- Storing settings (► page 102)

Steering wheel heating

Switching on/off

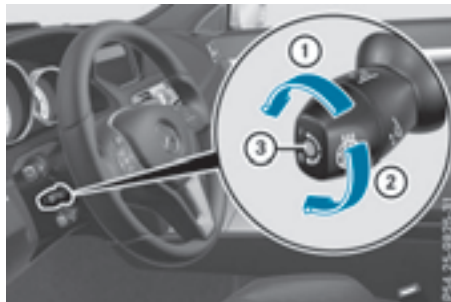

- ▶ Turn the SmartKey to position **2** in the ignition lock (▷ page 122).
- ▶ **To switch on/off:** turn the lever in the direction of arrow ① or ②.
Indicator lamp ③ lights up or goes out.

Vehicles without KEYLESS-GO: when you remove the SmartKey from the ignition lock, the steering wheel heating is deactivated.

Vehicles with KEYLESS-GO: when you switch off the ignition and open the driver's door, the steering wheel heating is deactivated.

- i** The steering wheel heating may switch off temporarily if:
 - the temperature in the vehicle interior is above 86 °F (30 °C)
 - the temperature of the steering wheel is above 95 °F (35 °C).
- Indicator lamp ③ remains on.

Problems with the steering wheel heating

| Problem | Possible causes/consequences and ► Solutions |
|---|---|
| The steering wheel heating has switched off prematurely or cannot be switched on. | <p>The on-board voltage is too low because too many electrical consumers are switched on.</p> <p>► Switch off electrical consumers that you do not need, such as the rear window defroster or interior lighting.</p> <p>Once the battery is sufficiently charged, the steering wheel heating will switch back on automatically.</p> |

EASY-ENTRY/EXIT feature

Important safety notes

WARNING

When the EASY-ENTRY/EXIT feature adjusts the steering wheel, you and other vehicle occupants – particularly children – could become trapped. There is a risk of injury.

While the EASY-ENTRY/EXIT feature is making adjustments, make sure that no one has any body parts in the sweep of the steering wheel.

Move the steering wheel adjustment lever if there is a risk of entrapment by the steering wheel. The adjustment process is stopped.

Vehicles with a memory function: if there is a risk of becoming trapped by the steering wheel, you can also use one of the memory function position buttons. The adjustment process is stopped.

WARNING

If children activate the EASY-ENTRY/EXIT feature, they can become trapped, particularly when unattended. There is a risk of injury.

When leaving the vehicle, always take the SmartKey with you and lock the vehicle. Never leave children unsupervised in the vehicle.

WARNING

If you drive off while the EASY-ENTRY/EXIT feature is making adjustments, you could lose control of the vehicle. There is a risk of an accident.

Always wait until the adjustment process is complete before driving off.

The EASY-ENTRY/EXIT feature makes getting in and out of your vehicle easier.

You can activate and deactivate the EASY-ENTRY/EXIT feature in the on-board computer (► page 195).

Position of the steering wheel when the EASY-ENTRY/EXIT feature is active

The steering wheel swings upwards when you:

- remove the SmartKey from the ignition lock
- **with KEYLESS-GO:** open the driver's door; KEYLESS-GO must be in position **1**
- **with the SmartKey:** open the driver's door; the SmartKey is in position **0** or **1** must be in the ignition lock (► page 122).

 The steering wheel only moves upwards if it has not already reached the upper stop.

Position of the steering wheel for driving

The steering wheel is moved to the last selected position when:

- the driver's door is closed
- **with KEYLESS-GO:** you press the Start/Stop button once
or
- **with the SmartKey:** you insert the SmartKey into the ignition lock

When you close the driver's door with the ignition switched on, the steering wheel is also automatically moved to the previously set position.

The last position of the steering wheel is stored when you switch off the ignition or when you store the setting with the memory function (▷ page 102).

Crash-responsive EASY-EXIT feature

If the crash-responsive EASY-EXIT feature is triggered in an accident, the steering column will move upwards when the driver's door is opened. This occurs irrespective of the position of the SmartKey in the ignition lock. This makes it easier to exit the vehicle and rescue the occupants. The crash-responsive EASY-EXIT feature is only operational if the EASY-EXIT/ENTRY feature is activated in the on-board computer (▷ page 195).

Mirrors

Rear-view mirror



- ▶ **Anti-glare mode:** flick anti-glare lever ① forwards or back.

Exterior mirrors

Adjusting the exterior mirrors

WARNING

You could lose control of your vehicle if you do the following while driving:

- adjust the driver's seat, head restraint, steering wheel or mirrors
- fasten the seat belt

There is a risk of an accident.

Adjust the driver's seat, head restraint, steering wheel and mirror and fasten your seat belt before starting the engine.

WARNING

The exterior mirror on the front-passenger side reduces the size of the image. Visible objects are actually closer than they appear. This means that you could misjudge the distance from road users traveling behind, e.g. when changing lane. There is a risk of an accident.

For this reason, always make sure of the actual distance from the road users traveling behind by glancing over your shoulder.



- ▶ Turn the SmartKey to position **1** or **2** in the ignition lock (▷ page 122).
- ▶ Press button ① for the left-hand exterior mirror or button ② for the right-hand exterior mirror. The indicator lamp in the corresponding button lights up in red. The indicator lamp goes out again after some time. You can adjust the selected mirror using adjustment button ③ as long as the indicator lamp is lit.
- ▶ Press adjustment button ③ up, down, or to the left or right until you have adjusted the exterior mirror to the correct position. You should have a good overview of traffic conditions.

The convex exterior mirrors provide a larger field of vision.

After the engine has been started, the exterior mirrors are automatically heated if the rear window defroster is switched on and the outside

temperature is low. Heating takes a maximum of ten minutes.

- You can also heat up the exterior mirrors manually by switching on the rear window defroster.

Folding the exterior mirrors in or out electrically



- ▶ Turn the SmartKey to position **1** or **2** in the ignition lock (▷ page 122).
- ▶ Briefly press button **①**. Both exterior mirrors fold in or out.
- Make sure that the exterior mirrors are always folded out fully while driving. They could otherwise vibrate.
- If you are driving faster than 30 mph (47 km/h), you can no longer fold in the exterior mirrors.

Setting the exterior mirrors

If the battery has been disconnected or completely discharged, the exterior mirrors must be reset. The exterior mirrors will otherwise not fold in when you select the "Fold in mirrors when locking" function in the on-board computer (▷ page 196).

- ▶ Turn the SmartKey to position **1** in the ignition lock (▷ page 122).
- ▶ Briefly press button **①**.

Folding the exterior mirrors in or out automatically

This function is only available in Canada.

If the "Fold in mirrors when locking" function is activated in the on-board computer (▷ page 196):

- the exterior mirrors fold in automatically as soon as you lock the vehicle from the outside.
- the exterior mirrors fold out again automatically as soon as you unlock the vehicle and then open the driver's or front-passenger door.

- If the exterior mirrors have been folded in manually, they do not fold out.

Exterior mirror pushed out of position

If an exterior mirror has been pushed out of position, proceed as follows:

- ▶ **Vehicles without electrically folding exterior mirrors:** move the exterior mirror into the correct position manually.
- ▶ **Vehicles with electrically folding exterior mirrors:** press and hold mirror-folding button until you hear a click and then the mirrors engage in position (▷ page 100). The mirror housing is engaged again and you can adjust the exterior mirrors as usual (▷ page 99).

Automatic anti-glare mirrors

WARNING

Electrolyte may escape if the glass in an automatic anti-glare mirror breaks. The electrolyte is harmful and causes irritation. It must not come into contact with your skin, eyes, respiratory organs or clothing or be swallowed. There is a risk of injury.

If you come into contact with the electrolyte, observe the following:

- Rinse off the electrolyte from your skin immediately with water.
- Immediately rinse the electrolyte out of your eyes thoroughly with clean water.
- If the electrolyte is swallowed, immediately rinse your mouth out thoroughly. Do not induce vomiting.
- If electrolyte comes into contact with your skin or hair or is swallowed, seek medical attention immediately.

- Immediately change out of clothing which has come into contact with electrolyte.
- If an allergic reaction occurs, seek medical attention immediately.

The rear-view mirror and the exterior mirror on the driver's side automatically go into anti-glare mode if the following conditions are met simultaneously:

- the ignition is switched on and
- incident light from headlamps strikes the sensor in the rear-view mirror

The mirrors do not go into anti-glare mode if reverse gear is engaged.

Parking position for the exterior mirror on the front-passenger side

Setting and storing the parking position

You can position the front-passenger side exterior mirror in such a way that you can see the rear wheel on that side as soon as you engage reverse gear. You can store this position.

Using reverse gear

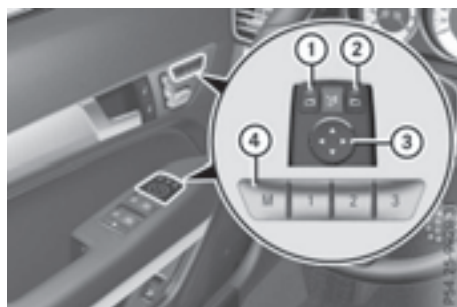

- ① Button for the driver's side exterior mirror
- ② Button for the front-passenger side exterior mirror
- ③ Adjustment button
- ④ Memory button **M**

- ▶ Stop the vehicle and turn the SmartKey to position **2** in the ignition lock (> page 122).
- ▶ Press button ② for the exterior mirror on the front-passenger side.

- ▶ Engage reverse gear. The exterior mirror on the front-passenger side moves to the preset parking position.
- ▶ Use adjustment button ③ to adjust the exterior mirror to a position that allows you to see the rear wheel and the curb. The parking position is stored.

i If you shift the transmission to another position, the exterior mirror on the front-passenger side returns to the driving position.

Using the memory button

You can store the parking position of the exterior mirror on the front-passenger side using memory button **M** ④. The reverse gear must not be engaged.

- ▶ Turn the SmartKey to position **2** in the ignition lock (> page 122).
- ▶ With the exterior mirror on the front-passenger side activated, use adjustment button ③ to adjust the exterior mirror. In the exterior mirror, the rear wheel and the curb should be visible.
- ▶ Press memory button **M** ④ and one of the arrows on adjustment button ③ within three seconds. The parking position is stored if the exterior mirror does not move.
- ▶ If the mirror moves out of position, repeat these steps.

Calling up a stored parking position setting

- ▶ Turn the SmartKey to position **2** in the ignition lock (> page 122).
- ▶ Adjust the exterior mirror on the front-passenger side using button ②.
- ▶ Engage reverse gear. The exterior mirror on the front-passenger side moves to the stored parking position. The exterior mirror on the front-passenger side moves back to its original position:
 - as soon as you exceed a speed of 9 mph (15 km/h)
 - if you press button ① for the exterior mirror on the driver's side

Memory function

Storing settings

WARNING

If you use the memory function on the driver's side while driving, you could lose control of the vehicle as a result of the adjustments being made. There is a risk of an accident. Only use the memory function on the driver's side when the vehicle is stationary.

WARNING

Children could become trapped if they activate the memory function, particularly when unattended. There is a risk of injury. When leaving the vehicle, always take the SmartKey with you and lock the vehicle. Never leave children unsupervised in the vehicle.

WARNING

When the memory function adjusts the seat or steering wheel, you and other vehicle occupants – particularly children – could become trapped. There is a risk of injury.

While the memory function is making adjustments, make sure that no one has any body parts in the sweep of the seat or steering wheel. If somebody becomes trapped, immediately release the memory function position button. The adjustment process is stopped.

The memory function can be used at any time, e.g. even when the SmartKey isn't in the ignition lock.

With the memory function, you can store up to three different settings, e.g. for three different people.



- ▶ Adjust the seat (▷ page 92).
- ▶ On the driver's side, adjust the steering wheel (▷ page 96) and the exterior mirrors (▷ page 99).
- ▶ Press memory button **M** and one of the storage position buttons **1**, **2** or **3** within three seconds. The settings are stored in the selected preset position. A tone sounds when the settings have been completed.

Calling up a stored setting

- ▶ Press and hold the relevant storage position button **1**, **2** or **3**, until the seat, steering wheel and exterior mirrors are in the stored position.
-  The setting procedure is interrupted as soon as you release the storage position button.

Exterior lighting

General notes

For reasons of safety, Mercedes-Benz recommends that you drive with the lights switched on even during the daytime. Therefore, your vehicle is equipped with special daytime running lamps. In some countries, operation of the headlamps varies due to legal requirements and self-imposed obligations.

If you wish to drive during the daytime without lights, switch off the daytime running lamps function in the on-board computer (▷ page 194).

Setting the exterior lighting

Setting options

Exterior lighting can be set using:

- the light switch
- the combination switch (▷ page 104)
- the on-board computer (▷ page 194)

Light switch

Operation

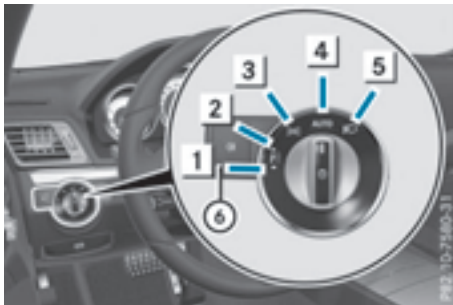

- | | | |
|---|-------------|--|
| 1 | | Left-hand standing lamps |
| 2 | | Right-hand standing lamps |
| 3 | | Parking lamps, license plate and instrument cluster lighting |
| 4 | AUTO | Automatic headlamp mode, controlled by the light sensor |
| 5 | | Low-beam/high-beam headlamps |
| 6 | | Rear fog lamp |

If you hear a warning tone when you leave the vehicle, the lights may still be switched on.

- ▶ Turn the light switch to **AUTO**.

The exterior lighting (except the parking/standing lamps) switches off automatically if you:

- remove the SmartKey from the ignition lock
- open the driver's door with the SmartKey in position **0** in the ignition lock

Automatic headlamp mode

WARNING

When the light switch is set to **AUTO**, the low-beam headlamps may not be switched on automatically if there is fog, snow or other causes of poor visibility due to the weather conditions such as spray. There is a risk of an accident.

In such situations, turn the light switch to



The automatic headlamp feature is only an aid. The driver is responsible for the vehicle's lighting at all times.

AUTO is the favored light switch setting. The light setting is automatically selected according to the brightness of the ambient light (exception: poor visibility due to weather conditions such as fog, snow or spray):

- SmartKey in position **1** in the ignition lock: the parking lamps are switched on or off automatically depending on the brightness of the ambient light.
- With the engine running: if you have activated the **Daytime Running Lights** function via the on-board computer, the daytime running lamps or the parking lamps and the low-beam headlamps are switched on or off automatically depending on the brightness of the ambient light.

- ▶ **To switch on automatic headlamp mode:** turn the light switch to **AUTO**.

Canada only:

The daytime running lamps improve the visibility of your vehicle during the day. The daytime running lamps function is required by law in Canada. It cannot therefore be deactivated.

When the engine is running and the vehicle is stationary: if you move the selector lever from a drive position to **P**, the daytime running lamps/



low-beam headlamps go out after three minutes.

When the engine is running, the vehicle is stationary and in bright ambient light: if you turn the light switch to , the daytime running lamps and parking lamps switch on.

If the engine is running and you turn the light switch to , the manual settings take precedence over the daytime running lamps.

USA only:

The daytime running lamps improve the visibility of your vehicle during the day. To do this, the daytime running lamps function must be switched on using the on-board computer (> page 194).

If the engine is running and you turn the light switch to  or , the manual settings take precedence over the daytime running lamps.



Low-beam headlamps

WARNING

When the light switch is set to , the low-beam headlamps may not be switched on automatically if there is fog, snow or other causes of poor visibility due to the weather conditions such as spray. There is a risk of an accident.







In such situations, turn the light switch to .

Even if the light sensor does not detect that it is dark, the parking lamps and low-beam headlamps switch on when the ignition is switched on and the light switch is set to the  position. This is a particularly useful function in the event of rain and fog.





- ▶ **To switch on the low-beam headlamps:** turn the SmartKey in the ignition lock to position **2** or start the engine.
- ▶ Turn the light switch to . The green  indicator lamp in the instrument cluster lights up.



Rear fog lamp

The rear fog lamp improves visibility of your vehicle for the traffic behind in the event of thick fog. Please take note of the country-specific regulations for the use of rear fog lamps.

- ▶ **To switch on the rear fog lamp:** turn the SmartKey in the ignition lock to position **2** or start the engine.
- ▶ Turn the light switch to  or .
- ▶ Press the  button. The yellow  indicator lamp in the instrument cluster lights up.
- ▶ **To switch off the rear fog lamp:** press the  button. The yellow  indicator lamp in the instrument cluster goes out.



Parking lamps

 If the battery charge is very low, the parking lamps or standing lamps are automatically switched off to enable the next engine start. Always park your vehicle safely and sufficiently lit according to legal standards. Avoid using the parking lamps  over a period of several hours. If possible, switch on the right-hand  or left-hand  standing lamp.

- ▶ **To switch on:** turn the light switch to . The green  indicator lamp in the instrument cluster lights up.

Standing lamps

Switching on the standing lamps ensures the corresponding side of the vehicle is illuminated.

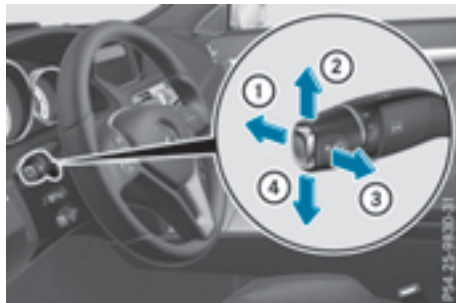

- ▶ **To switch on the standing lamps:** the SmartKey should not be in the ignition lock or it should be in position **0**.
- ▶ Turn the light switch to  (left-hand side of the vehicle) or  (right-hand side of the vehicle).

Combination switch



- ① High-beam headlamps
- ② Turn signal, right

- ③ High-beam flasher
- ④ Turn signal, left

- ▶ **To indicate briefly:** press the combination switch briefly to the pressure point in the direction of arrow ② or ④.
The corresponding turn signal flashes three times.
- ▶ **To indicate:** press the combination switch beyond the pressure point in the direction of arrow ② or ④.
- ▶ **To switch on the high-beam headlamps manually:** turn the SmartKey to position 2 in the ignition lock or start the engine.
- ▶ Vehicles without Adaptive Highbeam Assist: turn the light switch to  or **AUTO**.
- ▶ Vehicles with Adaptive Highbeam Assist: turn the light switch to .
- ▶ Press the combination switch beyond the pressure point in the direction of arrow ①.
In the **AUTO** position, the high-beam headlamps are only switched on when it is dark and the engine is running.
The blue  indicator lamp in the instrument cluster lights up when the high-beam headlamps are switched on.
- ▶ **To switch off the high-beam headlamps:** move the combination switch back to its normal position.
The blue  indicator lamp in the instrument cluster goes out.

Vehicles with Adaptive Highbeam Assist: if Adaptive Highbeam Assist is activated, it automatically controls activation and deactivation of the high-beam headlamps (▶ page 105).

Hazard warning lamps



- ▶ **To switch on the hazard warning lamps:** press button ①.
All turn signals flash. If you now switch on a turn signal using the combination switch, only the turn signal lamp on the corresponding side of the vehicle will flash.
- ▶ **To switch off the hazard warning lamps:** press button ①.

The hazard warning lamps automatically switch on if:

- an air bag is deployed or
- the vehicle decelerates rapidly from a speed of above 45 mph (70 km/h) and comes to a standstill

The hazard warning lamps switch off automatically if the vehicle reaches a speed of above 6 mph (10 km/h) again after a full brake application.

- i** The hazard warning lamps still operate if the ignition is switched off.

Cornering light function

The cornering light function improves the illumination of the road over a wide angle in the direction you are turning, enabling better visibility in tight bends, for example. It can only be activated when the low-beam headlamps are switched on.

Active:

- if you are driving at speeds below 25 mph (40 km/h) and switch on the turn signal or turn the steering wheel
- if you are driving at speeds between 25 mph (40 km/h) and 45 mph (70 km/h) and turn the steering wheel

The cornering lamp may remain lit for a short time, but is automatically switched off after no more than three minutes.

Adaptive Highbeam Assist

General notes

You can use this function to set the headlamps to change between low beam and high beam automatically. The system recognizes vehicles with their lights on, either approaching from the opposite direction or traveling in front of your

vehicle, and consequently switches the headlamps from high beam to low beam.

The system automatically adapts the low-beam headlamp range depending on the distance to the other vehicle. Once the system no longer detects any other vehicles, it reactivates the high-beam headlamps.

The system's optical sensor is located behind the windshield near the overhead control panel.

Important safety notes

WARNING

Adaptive Highbeam Assist does not recognize road users:

- who have no lights, e.g. pedestrians
- who have poor lighting, e.g. cyclists
- whose lighting is blocked, e.g. by a barrier

In very rare cases, Adaptive Highbeam Assist may fail to recognize other road users that have lights, or may recognize them too late. In this or similar situations, the automatic high-beam headlamps will not be deactivated or activated regardless. There is a risk of an accident.



Always carefully observe the traffic conditions and switch off the high-beam headlamps in good time.

Adaptive Highbeam Assist cannot take into account road, weather or traffic conditions. Adaptive Highbeam Assist is only an aid. You are responsible for adjusting the vehicle's lighting to the prevailing light, visibility and traffic conditions.

In particular, the detection of obstacles can be restricted if there is:

- poor visibility, e.g. due to fog, heavy rain or snow
- dirt on the sensors or the sensors are obscured

Switching Adaptive Highbeam Assist on/off



- **To switch on:** turn the light switch to .
- Press the combination switch beyond the pressure point in the direction of arrow . The  indicator lamp in the multifunction display lights up when it is dark and the light sensor activates the low-beam headlamps. If you are driving at speeds above approximately 16 mph (25 km/h):

The headlamp range is set automatically depending on the distance between the vehicle and other road users.

If you are driving at speeds above approximately 19 mph (30 km/h) and no other road users have been detected:

The high-beam headlamps are switched on automatically. The  indicator lamp in the instrument cluster also lights up.

If you are driving at speeds below approximately 16 mph (25 km/h) or other road users have been detected or the roads are adequately lit:

The high-beam headlamps are switched off automatically. The  indicator lamp in the instrument cluster goes out. The  indicator lamp in the multifunction display remains lit.

- **To switch off:** move the combination switch back to its normal position or move the light switch to another position. The  indicator lamp in the instrument cluster goes out.





Headlamps fogged up on the inside

Certain climatic and physical conditions may cause moisture to form in the headlamp. This moisture does not affect the functionality of the headlamp.

Interior lighting

Overview of interior lighting



- ①  Switches the rear interior lighting on/off
- ②  Switches the automatic interior lighting control on/off
- ③  Switches the right-hand reading lamp on/off
- ④  Switches the front interior lighting on/off
- ⑤  Switches the left-hand reading lamp on/off

Interior lighting control

General notes

In order to prevent the vehicle's battery from discharging, the interior lighting functions are automatically deactivated after some time except when the SmartKey is in position **2** in the ignition lock.

Automatic interior lighting control

- **To switch on/off:** press the  button.
When the automatic interior lighting control is activated, the button is flush with the overhead control panel.

The interior lighting automatically switches on if you:

- unlock the vehicle
- open a door
- remove the SmartKey from the ignition lock

The interior light is activated for a short while when the SmartKey is removed from the ignition lock. You can activate this delayed switch-off using the on-board computer (▷ page 195).

Replacing bulbs

Important safety notes

WARNING

Bulbs, lamps and connectors can get very hot when operating. If you change a bulb, you could burn yourself on these components. There is a risk of injury.

Allow these components to cool down before changing a bulb.

Vehicles with static LED headlamps:

Do not use a bulb that has been dropped or if its glass tube has been scratched.

The bulb may explode if:

- you touch it
- it is hot
- you drop it
- you scratch it

Only operate bulbs in enclosed lamps designed for that purpose. Only install spare bulbs of the same type and the specified voltage.

Marks on the glass tube reduce the service life of the bulbs. Do not touch the glass tube with your bare hands. If necessary, clean the glass tube when cold with alcohol or spirit and rub it off with a lint-free cloth.

Protect bulbs from moisture during operation. Do not allow bulbs to come into contact with liquids.

Only replace the bulbs listed (▷ page 108).

Have the bulbs that you cannot replace yourself replaced at a qualified specialist workshop.

If you require assistance replacing bulbs, consult a qualified specialist workshop.

If the new bulb still does not light up, consult a qualified specialist workshop.

Headlamps and lights are an important aspect of vehicle safety. You must therefore make sure that these function correctly at all times. Have the headlamp setting checked regularly.

Vehicles with static LED headlamps

The front and rear light clusters of your vehicle are equipped with LED light bulbs. Do not replace the bulbs yourself. Contact a qualified specialist workshop which has the necessary specialist knowledge and tools to carry out the work required.

Lamps are an important aspect of vehicle safety. You must therefore make sure that these function correctly at all times. Have the headlamp setting checked regularly.

Overview: changing bulbs/bulb types

You can replace the following bulbs. The bulb type can be found in the legend.



Static LED headlamps

① High-beam headlamp: H7 55 W

Changing the front bulbs

High-beam headlamps (static LED headlamps)

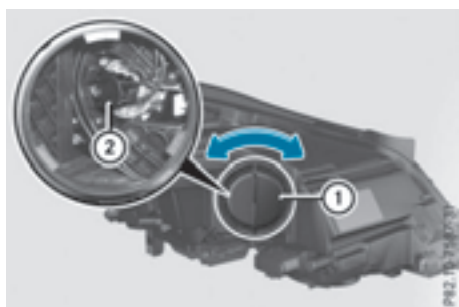

- ▶ Switch off the lights.
- ▶ Open the hood.
- ▶ Turn housing cover ① counter-clockwise and remove it.
- ▶ Turn bulb holder ② counter-clockwise and pull out.
- ▶ Pull the bulb out of bulb holder ②.
- ▶ Insert the new bulb into bulb holder ②.

- ▶ Insert bulb holder ② and turn it clockwise.
- ▶ Press on housing cover ① and turn it to the right.

Windshield wipers

Switching the windshield wipers on/off

❗ Do not operate the windshield wipers when the windshield is dry, as this could damage the wiper blades. Moreover, dust that has collected on the windshield can scratch the glass if wiping takes place when the windshield is dry.

If it is necessary to switch on the windshield wipers in dry weather conditions, always use washer fluid when operating the windshield wipers.



❗ If the windshield wipers leave smears on the windshield after the vehicle has been washed in an automatic car wash, wax or other residues may be the reason for this. Clean the windshield using washer fluid after washing the vehicle in an automatic car wash.

❗ Intermittent wiping with rain sensor: due to optical influences and the windshield becoming dirty in dry weather conditions, the windshield wipers may be activated inadvertently. This could then damage the windshield wiper blades or scratch the windshield.





For this reason, you should always switch off the windshield wipers in dry weather.



- ① 0 Windshield wiper off
- ② ... Intermittent wipe, low (rain sensor set to low sensitivity)
- ③ Intermittent wipe, high (rain sensor set to high sensitivity)
- ④ — Continuous wipe, slow

- 5  Continuous wipe, fast
- 6  Single wipe
-  To wipe with washer fluid

- ▶ Switch on the ignition.
- ▶ Turn the combination switch to the corresponding position.

In the  or  position, the appropriate wiping frequency is set automatically according to the intensity of the rain. In the  position, the rain sensor is more sensitive than in the  position, causing the windshield wiper to wipe more frequently.

If the wiper blades are worn, the windshield will no longer be wiped properly. This could prevent you from observing the traffic conditions.

Replacing the wiper blades

Important safety notes

WARNING

If the windshield wipers begin to move while you are changing the wiper blades, you could be trapped by the wiper arm. There is a risk of injury.

Always switch off the windshield wipers and ignition before changing the wiper blades.

-  To avoid damaging the wiper blades, make sure that you touch only the wiper arm of the wiper.

-  Never open the hood if a windshield wiper arm has been folded away from the windshield.

Never fold a windshield wiper arm without a wiper blade back onto the windshield.

Hold the windshield wiper arm firmly when you change the wiper blade. If you release the windshield wiper arm without a wiper blade and it falls onto the windshield, the windshield may be damaged by the force of the impact.

Mercedes-Benz recommends that you have the wiper blades changed at a qualified specialist workshop.

Replacing the wiper blades

Removing the wiper blades

- ▶ Remove the SmartKey from the ignition lock or turn it to position **0** (KEYLESS-GO).
- ▶ Fold the wiper arm away from the windshield.



- ▶ Firmly press release knob ① and pull wiper blade ② upwards from the wiper arm in the direction of the arrow.

Installing the wiper blades



- ▶ Position new wiper blade ① in the retainer on the wiper arm and slide it into place in the direction of the arrow. The wiper blade audibly engages.
- ▶ Make sure that the wiper blade is seated correctly.
- ▶ Fold the wiper arm back onto the windshield.

Problems with the windshield wipers

| Problem | Possible causes/consequences and ► Solutions |
|---|---|
| <p>The windshield wipers are jammed.</p> | <p>Leaves or snow, for example, may be obstructing the windshield wiper movement. The wiper motor has been deactivated.</p> <ul style="list-style-type: none"> ► For safety reasons, you should remove the SmartKey from the ignition lock. <p>or</p> <ul style="list-style-type: none"> ► Switch off the engine using the Start/Stop button and open the driver's door. ► Remove the cause of the obstruction. ► Switch the windshield wipers back on. |
| <p>The windshield wipers fail completely.</p> | <p>The windshield wiper drive is malfunctioning.</p> <ul style="list-style-type: none"> ► Select another wiper speed on the combination switch. ► Have the windshield wipers checked at a qualified specialist workshop. |

Overview of climate control systems

General notes

Observe the settings recommended on the following pages. The windows could otherwise fog up.

To prevent the windows from fogging up:

- switch off climate control only briefly
- switch on air-recirculation mode only briefly
- switch on the cooling with air dehumidification function
- switch on the defrost windshield function briefly, if required

Climate control regulates the temperature and the humidity in the vehicle interior and filters undesirable substances out of the air.

Climate control can only be operated when the engine is running. Optimum operation is only achieved with the side windows and roof closed.

The residual heat function can only be activated or deactivated with the ignition switched off (▷ page 119).

- i** Ventilate the vehicle for a brief period during warm weather, e.g. using the convenience opening feature (▷ page 83). This will speed up the cooling process and the desired interior temperature will be reached more quickly.
- i** The integrated filter filters out most particles of dust and soot and completely filters out pollen. It also reduces gaseous pollutants and odors. A clogged filter reduces the amount of air supplied to the vehicle interior. For this reason, you should always observe the interval for replacing the filter, which is specified in the Maintenance Booklet. As it depends on environmental conditions, e.g. heavy air pollution, the interval may be shorter than stated in the Maintenance Booklet.
- i** It is possible that the residual heat function may be activated automatically an hour after the SmartKey is removed. The vehicle is then ventilated for 30 minutes to dry the automatic climate control.

Control panel for dual-zone automatic climate control

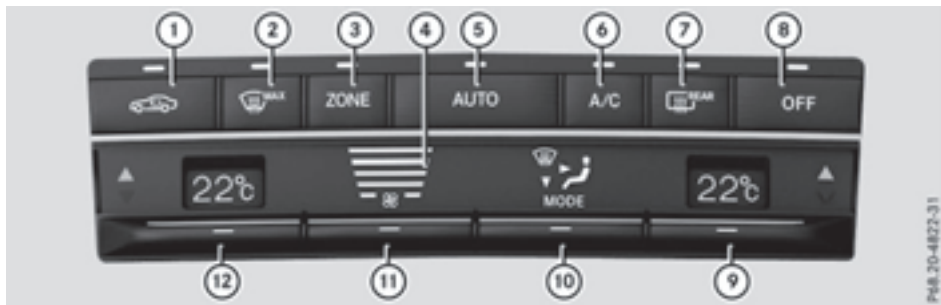

Canada only

- ① Switches air-recirculation mode on/off (▷ page 119)
- ② Defrosts the windshield (▷ page 117)
- ③ Switches the ZONE function on/off (▷ page 117)
- ④ Display
- ⑤ Sets climate control to automatic (▷ page 115)
- ⑥ Switches cooling with air dehumidification on/off (▷ page 115)
- ⑦ Switches the rear window defroster on/off (▷ page 118)
- ⑧ Activates/deactivates climate control (▷ page 114)
- ⑨ Sets the temperature, right (▷ page 116)
- ⑩ Sets the air distribution (▷ page 116)
- ⑪ Sets the airflow (▷ page 117)
- ⑫ Sets the temperature, left (▷ page 116)

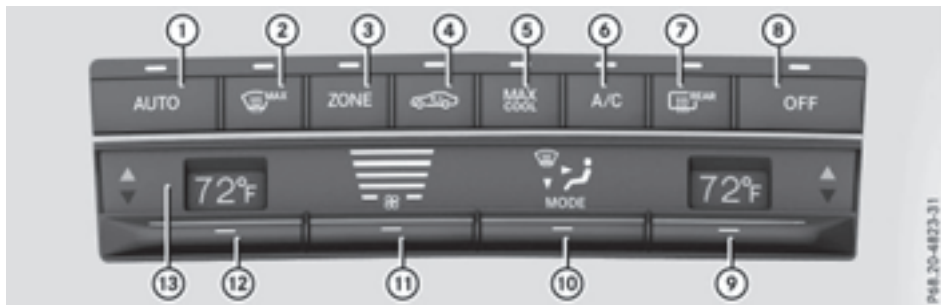

USA only

- ① Sets climate control to automatic (▷ page 115)
- ② Defrosts the windshield (▷ page 117)
- ③ Switches the ZONE function on/off (▷ page 117)
- ④ Switches air-recirculation mode on/off (▷ page 119)
- ⑤ Switches the maximum cooling MAX COOL on or off (▷ page 117)
- ⑥ Switches cooling with air dehumidification on/off (▷ page 115)
- ⑦ Switches the rear window defroster on/off (▷ page 118)
- ⑧ Activates/deactivates climate control (▷ page 114)
- ⑨ Sets the temperature, right (▷ page 116)
- ⑩ Sets the air distribution (▷ page 116)

- ⑪ Sets the airflow (▷ page 117)
- ⑫ Sets the temperature, left (▷ page 116)
- ⑬ Display

Control panel for 3-zone automatic climate control

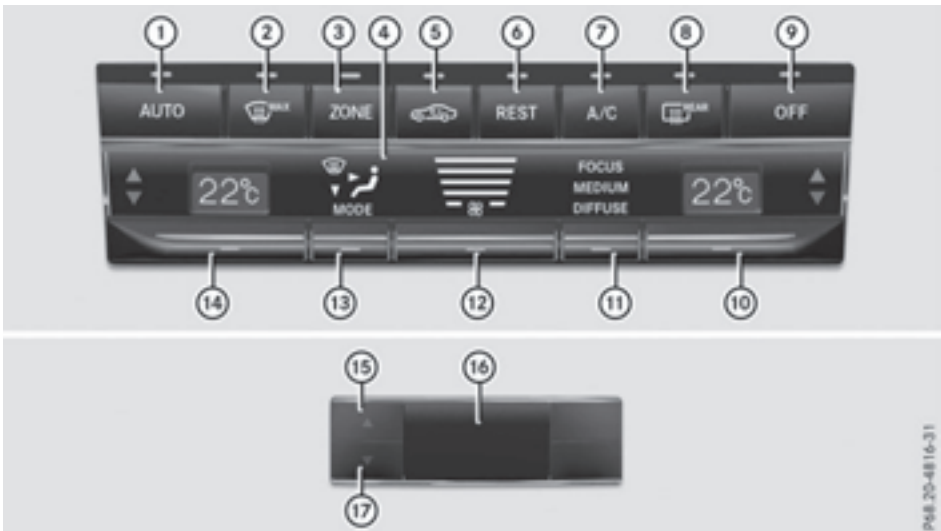

Canada only

Front control panel

- ① Sets climate control to automatic (▷ page 115)
- ② Defrosts the windshield (▷ page 117)
- ③ Switches the ZONE function on/off (▷ page 117)
- ④ Display
- ⑤ Switches air-recirculation mode on/off (▷ page 119)
- ⑥ Switches the residual heat on or off (▷ page 119)
- ⑦ Switches cooling with air dehumidification on/off (▷ page 115)
- ⑧ Switches the rear window defroster on/off (▷ page 118)
- ⑨ Activates/deactivates climate control (▷ page 114)
- ⑩ Sets the temperature, right (▷ page 116)
- ⑪ Adjusts the climate mode settings (▷ page 116)
- ⑫ Sets the airflow (▷ page 117)
- ⑬ Sets the air distribution (▷ page 116)
- ⑭ Sets the temperature, left (▷ page 116)

Rear control panel

- ⑮ Increases the temperature (▷ page 116)
- ⑯ Display
- ⑰ Reduces the temperature (▷ page 116)

Optimum use of automatic climate control

Climate control system

Below, you can find a number of notes and recommendations to help you use climate control optimally.

The 3-zone automatic climate control is only available on vehicles for Canada.

- Activate climate control using the **AUTO** and **A/C** buttons. The indicator lamps above the **A/C** and **A/C** buttons light up.
- Vehicles with 3-zone automatic climate control: in automatic mode, you can also set the climate mode (FOCUS, MEDIUM or DIFFUSE). The MEDIUM level is recommended.
- Set the temperature to 72 °F (22 °C).
- Only use the "Windshield defrosting" function briefly until the windshield is clear again.
- Only use air-recirculation mode briefly, e.g. if there are unpleasant outside odors or when in a tunnel. The windows could otherwise fog up, since no fresh air is drawn into the vehicle in air-recirculation mode.
- Use the ZONE function to adopt the temperature settings on the driver's side for the front-passenger side and the rear compartment as well. The indicator lamp above the **ZONE** button goes out.
- Vehicles with 3-zone automatic climate control: use the residual heat function if you want to heat or ventilate the vehicle interior when the ignition is switched off. The residual heat function can only be activated or deactivated with the ignition switched off.
- If you change the settings of the climate control system, the climate status display appears for approximately three seconds at the bottom of the screen in the multimedia system display. You will see the current settings of the various climate control functions.

ECO start/stop function

During automatic engine switch-off, the climate control system only operates at a reduced capacity. If you require the full climate control output, you can switch off the ECO start/stop function by pressing the ECO button (▷ page 126).

Operating the climate control systems

Activating/deactivating climate control

General notes

When the climate control is switched off, the air supply and air circulation are also switched off. The windows could fog up. Therefore, switch off climate control only briefly

- ❗ Activate climate control primarily using the **AUTO** button (▷ page 115).

Activating/deactivating

- ▶ Turn the SmartKey to position **2** in the ignition lock (▷ page 122).
- ▶ **To activate:** press the **AUTO** button. The indicator lamp above the **AUTO** button lights up. Airflow and air distribution are set to automatic mode.
- ▶ **To deactivate:** press the **OFF** button. The indicator lamp above the **OFF** button lights up.

Switching cooling with air dehumidification on/off





General notes

If you deactivate the "Cooling with air-dehumidification" function, the air inside the vehicle will not be cooled. The air inside the vehicle will also not be dehumidified. The windows can fog up more quickly. Therefore, deactivate the cooling with air-dehumidification function only briefly.

The "Cooling with air dehumidification" function is only available when the engine is running. The air inside the vehicle is cooled and dehumidified according to the temperature selected.

Condensation may drip from the underside of the vehicle when it is in cooling mode. This is normal and not a sign that there is a malfunction.

Switching on/off

- ▶ **To activate:** press the  button.
The indicator lamp above the  button lights up.
- ▶ **To deactivate:** press the  button.
The indicator lamp above the  button goes out. The "Cooling with air dehumidification" function has a delayed switch-off feature.

Problems with the "Cooling with air dehumidification" function

| Problem | Possible causes/consequences and ► Solutions |
|--|--|
| The indicator lamp over the  button flashes three times or remains off. The "Cooling with air dehumidification" function cannot be switched on. | Cooling with air dehumidification has been deactivated due to a malfunction. ► Visit a qualified specialist workshop. |



Setting climate control to automatic

General notes

In automatic mode, the set temperature is maintained automatically at a constant level. The system automatically regulates the temperature of the dispensed air, the airflow and the air distribution.

The "Cooling with air dehumidification" function is activated automatically in automatic mode.

Automatic control

- ▶ Turn the SmartKey to position **2** in the ignition lock (▷ page 122).
- ▶ Set the desired temperature.
- ▶ **To activate:** press the  button.
The indicator lamp above the  button lights up. Automatic air distribution and airflow are activated.
- ▶ **i** 3-zone automatic climate control: when automatic mode is activated, you can set the climate mode (▷ page 116).
- ▶ **To switch to manual mode:**
Dual-zone automatic climate control: press air distribution adjustment switch  (▷ page 112).

3-zone automatic climate control: press air distribution adjustment switch ⑬ (▷ page 113).

The indicator lamp above the **AUTO** button goes out.

or

▶ Dual-zone automatic climate control: press airflow adjustment switch ⑪ (▷ page 112).

3-zone automatic climate control: press air-flow adjustment switch ⑫ (▷ page 113).

The indicator lamp above the **AUTO** button goes out.

Adjusting the climate mode settings

The "Set climate mode" function is only available with 3-zone automatic climate control.

You can select the following climate mode settings in automatic mode:

- FOCUS high airflow, slightly cooler setting
- MEDIUM medium airflow, standard setting
- DIFFUSE low airflow, slightly warmer and draft-free setting

- ▶ Turn the SmartKey to position **2** in the ignition lock (▷ page 122).
- ▶ Press the **AUTO** button.
- ▶ Press climate mode selection button ⑪ up or down and select the desired level (▷ page 113).

Setting the temperature

Dual-zone automatic climate control

Different temperatures can be set for the driver's and front-passenger sides.

- ▶ Turn the SmartKey to position **2** in the ignition lock (▷ page 122).
- ▶ **To increase or reduce the temperature in the front compartment:** press temperature adjustment switch ⑨ or ⑫ up or down (▷ page 112).

Only change the temperature setting in small increments. Start at 72 °F (22 °C).

3-zone automatic climate control



You can select different temperature settings for the driver's and front-passenger sides as well as for the rear compartment.

- ▶ Turn the SmartKey to position **2** in the ignition lock (▷ page 122).
- ▶ **To increase or reduce the temperature in the front compartment:** press temperature adjustment switch ⑩ or ⑭ up or down (▷ page 113).

Only change the temperature setting in small increments. Start at 72 °F (22 °C).

- ▶ **To increase or reduce the temperature in the rear compartment using the front control panel:** press the **ZONE** button. The indicator lamp above the **ZONE** button goes out.





- ▶ Press temperature adjustment switch ⑩ or ⑭ up or down (▷ page 113). Only change the temperature setting in small increments. Start at 72 °F (22 °C).

- ▶ **To increase or reduce the temperature in the rear compartment using the rear control panel:** press the  or  button on the rear control panel.

Only change the temperature setting in small increments. Start at 72 °F (22 °C).

Setting the air distribution

Air distribution settings

-  Directs air through the center and side air vents
-  Directs air through the footwell air vents
-  Directs the airflow through the center and side air vents as well as the footwell air vents (Cabriolet only)
-  Directs air through the defroster vents
-  Directs air through the defroster and footwell vents

i Regardless of the air distribution setting, airflow is always directed through the side air vents. The side air vents can only be closed when the controls on the side air vents are turned downwards.

Setting the air distribution

- ▶ Turn the SmartKey to position **2** in the ignition lock (▷ page 122).
- ▶ Dual-zone automatic climate control: press air distribution adjustment switch **(10)** up or down, until the desired symbol appears in the display (▷ page 112).
- ▶ 3-zone automatic climate control: press air distribution adjustment switch **(13)** up or down, until the desired symbol appears in the display (▷ page 113).

Setting the airflow

Dual-zone automatic climate control





- ▶ Turn the SmartKey to position **2** in the ignition lock (▷ page 122).
- ▶ **To increase or reduce:** press airflow adjustment switch **(11)** up or down (▷ page 112).

3-zone automatic climate control

- ▶ Turn the SmartKey to position **2** in the ignition lock (▷ page 122).
- ▶ **To increase or reduce:** press airflow adjustment switch **(12)** up or down (▷ page 113).

If the battery is not sufficiently charged, blower output may be reduced. As soon as the battery is sufficiently charged, full blower output will be available.

Switching the ZONE function on/off



- ▶ **To activate:** press the  button. The indicator lamp above the  button lights up. Dual-zone automatic climate control: the temperature setting for the driver's side is not adopted for the front-passenger side. 3-zone automatic climate control: the temperature setting for the driver's side is not adopted for the front-passenger side and the rear compartment.
- ▶ **To deactivate:** press the  button. The indicator lamp above the  button goes out. Dual-zone automatic climate control: the temperature setting for the driver's side is adopted for the front-passenger side.

3-zone automatic climate control: the temperature setting for the driver's side is adopted for the front-passenger side and the rear compartment.



Defrosting the windshield

You can use this function to defrost the windshield or to clear a fogged up windshield or side windows on the inside.

Switch off the "Windshield defrosting" function as soon as the windshield is clear again.

- ▶ Turn the SmartKey to position **2** in the ignition lock (▷ page 122).
- ▶ **To activate:** press the  button. The indicator lamp above the  button lights up. The climate control system switches to the following functions:
 - high airflow
 - high temperature
 - air distribution to the windshield and front side windows
 - air-recirculation mode off





If the battery is not sufficiently charged, blower output may be reduced. Once the battery is sufficiently charged again, full blower output will be available again.

- ▶ **To deactivate:** press the  button. The indicator lamp above the  button goes out. The previously selected settings are restored. Air-recirculation mode remains deactivated.

MAX COOL maximum cooling

The MAX COOL function is only available in vehicles for the USA.



MAX COOL is only operational when the engine is running.

- ▶ **To activate:** press the  button. The indicator lamp in the  button lights up.
- ▶ **To deactivate:** press the  button. The indicator lamp in the  button goes out. The previously selected settings are restored.

When you activate MAX COOL, climate control switches to the following functions:



- maximum cooling
- maximum airflow
- air-recirculation mode on

Activating or deactivating







- ▶ Turn the SmartKey to position **2** in the ignition lock (▷ page 122).
- ▶ Press the  button. The indicator lamp above the  button lights up or goes out.

Defrosting the windows

Windows fogged up on the inside

- ▶ Activate the  cooling with air dehumidification function.
 - ▶ Activate automatic mode .
 - ▶ Adjust the side air vents so that the warmed air is directed to the side windows.
 - ▶ If the windows continue to fog up, activate the "windshield defrosting" function .
- i** You should only select this setting until the windshield is clear again.

Windows fogged up on the outside

- ▶ Climate control: press air distribution adjustment switch  up or down (▷ page 112), until the  or  symbol appears in the display.
- ▶ 3-zone automatic climate control: press air distribution adjustment switch  up or down (▷ page 113), until the  or  symbol appears in the display.
- ▶ Adjust the side air vents so that no air is directed to the side windows.

Rear window defroster

General notes

The rear window defroster has a high current draw. You should therefore switch it off as soon as the rear window is clear. Otherwise, the rear window defroster switches off automatically after several minutes.

If the battery voltage is too low, the rear window defroster may switch off.

Problems with the rear window defroster

| Problem | Possible causes/consequences and ► Solutions |
|---|---|
| The rear window defroster has deactivated prematurely or cannot be activated. | The battery has not been sufficiently charged. ► Switch off any consumers that are not required, e.g. reading lamps, interior lighting or the seat heating. When the battery is sufficiently charged, the rear window defroster can be activated again. |





Switching air-recirculation mode on/off

General notes

You can deactivate the flow of fresh air if unpleasant odors are entering the vehicle from outside. The air already inside the vehicle will then be recirculated.

If you switch on air-recirculation mode, the windows can fog up more quickly, in particular at low temperatures. Only use air-recirculation mode briefly to prevent the windows from fogging up.

Activating or deactivating

- Turn the SmartKey to position **2** in the ignition lock (► page 122).
- **To activate:** press the  button. The indicator lamp above the  button lights up.
- **To deactivate:** press the  button. The indicator lamp above the  button goes out.
- i** Air-recirculation mode deactivates automatically:
 - after approximately five minutes at outside temperatures below approximately 41 °F (5 °C)
 - after approximately five minutes if cooling with air dehumidification is deactivated
 - after approximately 30 minutes at outside temperatures above approximately 41 °F (5 °C) if the "Cooling with air dehumidification" function is activated





Switching the residual heat on or off

General notes

It is possible to make use of the residual heat of the engine to continue heating the vehicle for approximately 30 minutes after the engine has been switched off. The heating time depends on the set interior temperature.

The "residual heat" function only functions optimally with the side windows and panorama roof with power tilt/sliding panel closed.

Activating/deactivating

- Turn the SmartKey to position **0** in the ignition lock or remove it (► page 122).
 - **To activate:** press the  button. The indicator lamp above the  button lights up.
 - i** If the residual heat function is activated, the windows may fog up on the inside.
 - i** The blower will run at a low speed regardless of the airflow setting.
 - i** If you activate the residual heat function at high temperatures, only the ventilation will be activated. The blower runs at medium speed.
 - **To deactivate:** press the  button. The indicator lamp above the  button goes out.
- Residual heat is deactivated automatically:
- after approximately 30 minutes
 - when the ignition is switched on
 - if the battery voltage drops

Air vents

Important safety notes

WARNING

Very hot or very cold air can flow from the air vents. This could result in burns or frostbite in the immediate vicinity of the air vents. There is a risk of injury.

Make sure that all vehicle occupants always maintain a sufficient distance to the air outlets. If necessary, redirect the airflow to another area of the vehicle interior.

In order to ensure the direct flow of fresh air through the air vents into the vehicle interior, please observe the following notes:

- keep the air inlet between the windshield and the hood free of blockages, such as ice, snow or leaves.
- never cover the air vents or air intake grilles in the vehicle interior.

Setting the air vents

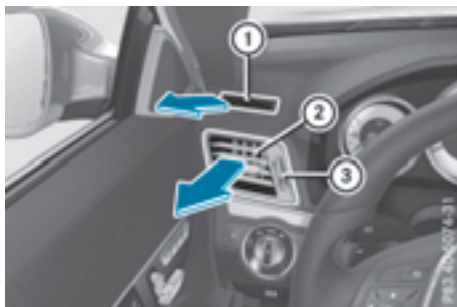

Example

- ① Defroster vent
- ② Side air vent
- ③ Thumbwheel for side air vent

► **To open or close:** turn thumbwheel ③ up or down.

Setting the glove box air vent

! Close the air vent when heating the vehicle. At high outside temperatures, open the air vent and activate the "cooling with air dehu-

midification" function. Otherwise, temperature-sensitive items stored in the glove box could be damaged.

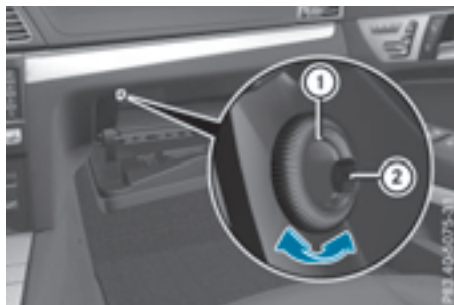

- ① Air vent control
- ② Air vent

When the climate control system is activated, the glove box can be ventilated, for instance to cool its contents. The level of airflow depends on the airflow and air distribution settings.

► **To open or close:** turn control ① to the clockwise or counter-clockwise.

Notes on breaking-in a new vehicle

Important safety notes

The sensor system of some driving and driving safety systems adjusts automatically while a certain distance is being driven after the vehicle has been delivered or after repairs. Full system effectiveness is not reached until the end of this teach-in procedure.

New and replaced brake pads and discs only reach their optimum braking effect after several hundred kilometers of driving. Compensate for this by applying greater force to the brake pedal.

The first 1000 miles (1500 km)

The more you look after the engine when it is new, the more satisfied you will be with its performance in the future.

- You should therefore drive at varying vehicle and engine speeds for the first 1000 miles (1500 km).
- Avoid heavy loads, e.g. driving at full throttle, during this period.
- Change gear in good time, before the tachometer needle is $\frac{2}{3}$ of the way to the red area of the tachometer.
- Try to avoid depressing the accelerator pedal beyond the point of resistance (kickdown).

After 1000 miles (1500 km), you can increase the engine speed gradually and accelerate the vehicle to full speed.

- i** You should also observe these notes on breaking in if the engine or parts of the drive train on your vehicle have been replaced.
- i** Always observe the respective maximum permissible speed.

Driving

Important safety notes

WARNING

Objects in the driver's footwell can restrict the pedal travel or obstruct a depressed pedal. The operating and road safety of the vehicle is jeopardized. There is a risk of an accident.

Make sure that all objects in the vehicle are stowed correctly, and that they cannot enter the driver's footwell. Install the floor mats securely and as specified in order to ensure sufficient clearance for the pedals. Do not use loose floor mats and do not place floor mats on top of one another.

WARNING

Unsuitable footwear can hinder correct usage of the pedals, e.g.:

- shoes with thick soles
- shoes with high heels
- slippers

There is a risk of an accident.

Wear suitable footwear to ensure correct usage of the pedals.

WARNING

If you switch off the ignition while driving, safety-relevant functions are only available with limitations, or not at all. This could affect, for example, the power steering and the brake boosting effect. You will require considerably more effort to steer and brake. There is a risk of an accident.

Do not switch off the ignition while driving.

WARNING

If the parking brake has not been fully released when driving, the parking brake can:

- overheat and cause a fire
- lose its hold function.

There is a risk of fire and an accident. Release the parking brake fully before driving off.

! Do not warm up the engine with the vehicle stationary. Drive off immediately. Avoid high engine speeds and driving at full throttle until the engine has reached its operating temperature.

Only shift the automatic transmission to the desired drive position when the vehicle is stationary.

Where possible, avoid spinning the drive wheels when pulling away on slippery roads. You could otherwise damage the drive train.

SmartKey positions

SmartKey



- 0 To remove the SmartKey (shift the transmission to position **P**)
 - 1 Power supply for some consumers, such as the windshield wipers
 - 2 Ignition (power supply for all consumers) and drive position
 - 3 To start the engine
- i** The SmartKey can be turned in the ignition lock even if it is not the correct SmartKey for the vehicle. The ignition is not switched on. The engine cannot be started.

KEYLESS-GO

General notes

Vehicles with KEYLESS-GO are equipped with Smartkeys featuring the integrated KEYLESS-GO function and a detachable Start/Stop button.

The Start/Stop button must be inserted in the ignition lock and the Smartkey must be in the vehicle.

When you insert the Start/Stop button into the ignition lock, the system needs approximately two seconds recognition time. You can then use the Start/Stop button.

Pressing the Start/Stop button several times in succession corresponds to the different key positions in the ignition lock. This is only the case if you are not depressing the brake pedal.

If you depress the brake pedal and press the Start/Stop button, the engine starts immediately.

A check which periodically establishes a radio connection between the vehicle and the Smartkey determines whether a valid Smartkey is in the vehicle. This occurs, for example, when starting the engine.

To start the vehicle without actively using the Smartkey:

- the Start/Stop button must be inserted in the ignition lock.
- the Smartkey must be in the vehicle.
- the vehicle must not be locked with the Smartkey or KEYLESS-GO (> page 73).

Do not keep the KEYLESS-GO key:

- with electronic devices, e.g. a mobile phone or another Smartkey.
 - with metallic objects, e.g. coins or metal foil.
 - inside metallic objects, e.g. a metal case.
- This can affect the functionality of KEYLESS-GO.

If you lock the vehicle with the Smartkey's remote control or with KEYLESS-GO, after a short time:

- you will not be able to switch on the ignition with the Start/Stop button.
- you will not be able to start the engine with the Start/Stop button until the vehicle is unlocked again.

If you lock the vehicle centrally using the button on the front door (> page 79), you can continue to start the engine with the Start/Stop button.

The engine can be switched off while the vehicle is in motion by pressing and holding the Start/Stop button for three seconds. This function operates independently of the ECO start/stop automatic engine switch-off function.

Key positions with KEYLESS-GO



- ① Start/Stop button
- ② Ignition lock

As soon as the ignition is switched on, all the indicator lamps in the instrument cluster light up. Further information on situations where an indicator lamp either fails to go out after starting the engine or lights up while driving (▷ page 221).

If Start/Stop button ① has not yet been pressed, this corresponds to the key being removed from the ignition.

► **To switch on the power supply:** press Start/Stop button ① once.
The power supply is switched on. You can now activate the windshield wipers, for example.

The power supply is switched off again if:

- the driver's door is opened and
- you press Start/Stop button ① twice when in this position

► **To switch on the ignition:** press Start/Stop button ① twice.
The ignition is switched on.

If you press Start/Stop button ① once when in this position, the ignition is deactivated again.

Removing the Start/Stop button

You can remove the Start/Stop button from the ignition lock and start the vehicle as normal using the Smartkey.

It is only possible to switch between Start/Stop button mode and Smartkey operation when the transmission is in position **P**.

- Remove Start/Stop button ① from ignition lock ②.

You do not have to remove the Start/Stop button from the ignition lock when you leave the vehicle. You should, however, always take the Smartkey with you when leaving the vehicle. As long as the Smartkey is in the vehicle:

- the vehicle can be started using the Start/Stop button
- the electrically powered equipment can be operated

Starting the engine

Important safety notes

⚠ WARNING

If children are left unsupervised in the vehicle, they could:

- open the doors, thus endangering other people or road users.
- get out and disrupt traffic.
- operate the vehicle's equipment.

Additionally, children could set the vehicle in motion if, for example, they:

- release the parking brake.
- shifting the automatic transmission out of park position **P**
- Start the engine.

There is a risk of an accident and injury.

When leaving the vehicle, always take the SmartKey with you and lock the vehicle. Never leave children or animals unattended in the vehicle. Always keep the SmartKey out of reach of children.

⚠ WARNING

Combustion engines emit poisonous exhaust gases such as carbon monoxide. Inhaling these exhaust gases leads to poisoning. There is a risk of fatal injury. Therefore never leave the engine running in enclosed spaces without sufficient ventilation.

 **WARNING**

Flammable materials introduced through environmental influence or by animals can ignite if in contact with the exhaust system or parts of the engine that heat up. There is a risk of fire.

Carry out regular checks to make sure that there are no flammable foreign materials in the engine compartment or in the exhaust system.

General notes

-  The catalytic converter is preheated for up to 30 seconds after a cold start. The sound of the engine may change during this time.

Automatic transmission

- ▶ Shift the transmission to position **P**. The transmission position display in the multifunction display shows **P**.
-  You can start the engine in transmission position **P** and **N**.

Starting procedure with the SmartKey

-  To start the engine using the SmartKey instead of KEYLESS-GO, pull the Start/Stop button out of the ignition lock.
- ▶ Turn the SmartKey to position **3** in the ignition lock and release it as soon as the engine is running (▷ page 122).

Using KEYLESS-GO to start the engine

-  The Start/Stop button can be used to start the vehicle manually without inserting the SmartKey into the ignition lock. The Start/Stop button must be inserted in the ignition lock and the SmartKey must be in the vehicle. This mode for starting the engine operates independently of the ECO start/stop automatic engine start function.
- ▶ Depress the brake pedal and keep it depressed.
- ▶ Press the Start/Stop button once (▷ page 122). The engine starts.

Pulling away**General notes** **WARNING**

If the engine speed is above the idling speed and you engage transmission position **D** or **R**, the vehicle could pull away suddenly. There is a risk of an accident.

When engaging transmission position **D** or **R**, always firmly depress the brake pedal and do not simultaneously accelerate.

-  If a warning tone sounds and the **Release Park. Brake** message appears in the multifunction display, the parking brake is still applied. Release the parking brake.

Depress the accelerator carefully when pulling away.

The vehicle locks centrally once you have pulled away. The locking knobs in the doors drop down. You can open the doors from the inside at any time.

You can also deactivate the automatic locking feature (▷ page 195).

It is only possible to shift the transmission from position **P** to the desired position if you depress the brake pedal. If you do not depress the brake pedal, the DIRECT SELECT lever can still be moved but the parking lock remains engaged.

-  Upshifts take place at higher engine speeds after a cold start. This helps the catalytic converter to reach its operating temperature more quickly.

Hill start assist

Hill start assist helps you when pulling away forwards or in reverse on an uphill gradient. It holds the vehicle for a short time after you have removed your foot from the brake pedal. This gives you enough time to move your foot from the brake pedal to the accelerator pedal and to depress it before the vehicle begins to roll.

 **WARNING**

After a short time, hill start assist will no longer brake your vehicle and it could roll away. There is a risk of an accident and injury.

Therefore, quickly move your foot from the brake pedal to the accelerator pedal. Never leave the vehicle when it is held by hill start assist.

Hill start assist is not active if:

- you are pulling away on a level road or on a downhill gradient.
- the transmission is in position **N**.
- the parking brake is applied.
- ESP® is malfunctioning.

ECO start/stop function

Introduction

The ECO start/stop function switches the engine off automatically if the vehicle is stopped under certain conditions.

The engine starts automatically when the driver wants to pull away again. The ECO start/stop function thereby helps you to reduce the fuel consumption and emissions of your vehicle.

Important safety notes

WARNING

If the engine is switched off automatically and you exit the vehicle, the engine is restarted automatically. The vehicle may begin moving. There is a risk of accident and injury.

If you wish to exit the vehicle, always turn off the ignition and secure the vehicle against rolling away.

General notes



① ECO start/stop display

The ECO start/stop function is activated whenever you start the engine using the Smartkey or the Start/Stop button.

If the engine has been switched off automatically by the ECO start/stop function, the **ECO** symbol is shown in the multifunction display.

Automatic engine switch-off

If the vehicle is braked to a standstill in **D** or **N**, the ECO start/stop function switches off the engine automatically.

The ECO start/stop function is operational when:

- the indicator lamp in the ECO button is lit green.
- the outside temperature is within the range that is suitable for the system.
- the engine is at normal operating temperature.
- the set temperature for the vehicle interior has been reached.
- the battery is sufficiently charged.
- the system detects that the windshield is not fogged up when the air-conditioning system is switched on.
- the hood is closed.
- the driver's door is closed and the driver's seat belt is fastened.

i All of the vehicle's systems remain active when the engine is stopped automatically.

i The HOLD function can also be activated if the engine has been switched off automatically. It is then not necessary to continue applying the brakes during the automatic stop phase. When you depress the accelerator pedal, the engine starts automatically and the braking effect of the HOLD function is deactivated.

i The engine can be switched off automatically a maximum of four times (first stop and three subsequent stops) in succession.

Automatic engine start

The engine starts automatically if:

- you switch off the ECO start/stop function by pressing the ECO button
- in transmission position **D** or **N** the brake pedal is released and the HOLD function is not active
- you depress the accelerator pedal
- you engage reverse gear **R**

- you move the transmission out of position **P**
- you unfasten your seat belt or open the driver's door
- the vehicle starts to roll
- the brake system requires this
- the temperature in the vehicle interior deviates from the set range
- the system detects moisture on the windshield when the air-conditioning system is switched on
- the battery's condition of charge is too low

i Shifting the transmission to position **P** does not start the engine.

Deactivating or activating the ECO start/stop function



- ▶ **To deactivate:** press ECO button ①. Indicator lamp ② goes out.
- ▶ **To activate:** press ECO button ①. Indicator lamp ② lights up.

If indicator lamp ② is off, the ECO start/stop function has been deactivated manually or as the result of a malfunction. The engine will then not be switched off automatically when the vehicle stops.

| Problems with the engine | |
|--|--|
| Problem | Possible causes/consequences and ► Solutions |
| The engine does not start. The starter motor can be heard. | <ul style="list-style-type: none"> • There is a malfunction in the engine electronics. • There is a malfunction in the fuel supply. <p>Before attempting to start the engine again:</p> <ul style="list-style-type: none"> ► Turn the Smartkey back to position 0 in the ignition lock. <p>or</p> <ul style="list-style-type: none"> ► Press the Start/Stop button repeatedly until all indicator lamps in the instrument cluster go out. ► Try to start the engine again (► page 123). Avoid excessively long and frequent attempts to start the engine as these will drain the battery. <p>If the engine does not start after several attempts:</p> <ul style="list-style-type: none"> ► Consult a qualified specialist workshop. |
| The engine does not start. You cannot hear the starter motor. | <p>The on-board voltage is too low because the battery is too weak or discharged.</p> <ul style="list-style-type: none"> ► Jump-start the vehicle (► page 274). <p>If the engine does not start despite attempts to jump-start it:</p> <ul style="list-style-type: none"> ► Consult a qualified specialist workshop. <p>The starter motor was exposed to a thermal load that was too high.</p> <ul style="list-style-type: none"> ► Allow the starter motor to cool down for approximately two minutes. ► Try to start the engine again. <p>If the engine still does not start:</p> <ul style="list-style-type: none"> ► Consult a qualified specialist workshop. |
| The engine is not running smoothly and is misfiring. | <p>There is a malfunction in the engine electronics or in a mechanical component of the engine management system.</p> <ul style="list-style-type: none"> ► Only depress the accelerator pedal slightly. Otherwise, non-combusted fuel may get into the catalytic converter and damage it. ► Have the cause rectified immediately at a qualified specialist workshop. |
| The coolant temperature gauge shows a value above 248 °F (120 °C). | <p>The coolant level is too low. The coolant is too hot and the engine is no longer being cooled sufficiently.</p> <ul style="list-style-type: none"> ► Stop as soon as possible and allow the engine and the coolant to cool down. ► Check the coolant level (► page 256). Observe the warning notes as you do so and add coolant if necessary. |

Automatic transmission

Important safety notes

WARNING

If the engine speed is above the idling speed and you engage transmission position **D** or **R**, the vehicle could pull away suddenly. There is a risk of an accident.

When engaging transmission position **D** or **R**, always firmly depress the brake pedal and do not simultaneously accelerate.

WARNING

The automatic transmission switches to neutral position **N** when you switch off the engine. The vehicle may roll away. There is a risk of an accident.

After switching off the engine, always switch to parking position **P**. Prevent the parked vehicle from rolling away by applying the parking brake.

DIRECT SELECT lever

Overview of transmission positions

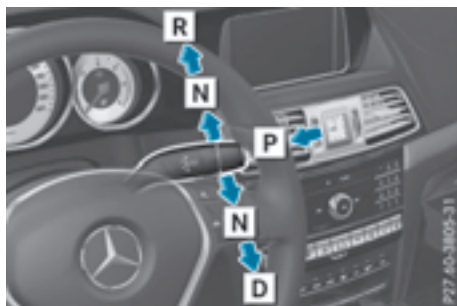

- P** Park position with parking lock
- R** Reverse gear
- N** Neutral
- D** Drive

The DIRECT SELECT lever is on the right of the steering column.

The DIRECT SELECT lever always returns to its original position. The current transmission position **P**, **R**, **N** or **D** appears in the transmission

position display in the multifunction display (> page 128).

Transmission position and drive program display

 If the transmission position display in the multifunction display is not working, you should pull away carefully to check whether the desired transmission position is engaged. Ideally, you should select transmission position **D** and drive program **E** or **S**.

The current transmission position and drive program appear in the multifunction display.

The arrows in the transmission position display show how and into which transmission positions you can change using the DIRECT SELECT lever.



- ① Transmission position display
- ② Drive program display

Engaging park position **P**

 If the engine speed is too high or the vehicle is moving, do not shift the automatic transmission directly from **D** to **R**, from **R** to **D** or directly to **P**. The automatic transmission could otherwise be damaged.

- ▶ Push the DIRECT SELECT lever in the direction of arrow **P**. Transmission position display **P** is shown in the multifunction display.

Depressing the brake and pushing the DIRECT SELECT lever up or down disengages the parking lock. The transmission is in **N** neutral.

In order to shift from park position **P** directly into **R** or **D**:

- depress the brake pedal and
- push the DIRECT SELECT lever up or down past the first point of resistance

Engaging park position P automatically

Park position **P** is automatically engaged if:

- you switch off the engine using the Smartkey and remove the Smartkey
- you switch off the engine using the Smartkey or using the Start/Stop button and open the driver's door or front-passenger door
- the driver's door is opened when the vehicle is stationary or driving at very low speed and the transmission is in position **D** or **R**

Under certain conditions, the automatic transmission shifts automatically to transmission position **P** if the HOLD function or DISTRONIC PLUS is activated. Observe the information on the HOLD function (▷ page 156) and on DISTRONIC PLUS (▷ page 150).

Engaging reverse gear R

! Only shift the automatic transmission to **R** when the vehicle is stationary.

- ▶ If the transmission is in position **D** or **N**: push the DIRECT SELECT lever up past the first point of resistance.
- ▶ If the transmission is in position **P**: depress the brake pedal and push the DIRECT SELECT lever up past the first point of resistance.

The ECO start/stop function is not available when reverse gear is engaged. Further information on the ECO start/stop function (▷ page 125).

Shifting to neutral N

WARNING

If children are left unsupervised in the vehicle, they could:

- open the doors, thus endangering other people or road users.
- get out and disrupt traffic.
- operate the vehicle's equipment.

Additionally, children could set the vehicle in motion if, for example, they:

- release the parking brake.
- shifting the automatic transmission out of park position **P**
- Start the engine.

There is a risk of an accident and injury.

When leaving the vehicle, always take the SmartKey with you and lock the vehicle. Never leave children or animals unattended in the vehicle. Always keep the SmartKey out of reach of children.

- ▶ If the transmission is in position **D** or **R**: push the DIRECT SELECT lever up or down to the first point of resistance.
- ▶ If the transmission is in position **P**: depress the brake pedal and push the DIRECT SELECT lever up or down to the first point of resistance.

If you switch the engine off with the transmission in position **R** or **D**, the automatic transmission shifts to **N** automatically.

With the Smartkey: if you then open the driver's door or the front-passenger door or remove the Smartkey from the ignition, the automatic transmission shifts to **P** automatically.

With KEYLESS-GO: if you then open the driver's or front-passenger door, the automatic transmission shifts to **P**.

If you want the automatic transmission to remain in neutral **N**, e.g. when having the vehicle cleaned in an automatic car wash with a towing system:

- ▶ **Vehicles with KEYLESS-GO:** remove the Start/Stop button from the ignition lock.
- ▶ Insert the Smartkey into the ignition lock.
- ▶ **All vehicles:** switch the ignition on.
- ▶ Depress the brake pedal and keep it depressed.
- ▶ Shift to neutral **N**.
- ▶ Release the brake pedal.
- ▶ Release the parking brake.
- ▶ Switch off the ignition and leave the Smartkey in the ignition lock.

Engaging drive position D

- ▶ If the transmission is in position **R** or **N**: push the DIRECT SELECT lever down past the first point of resistance.
- ▶ If the transmission is in position **P**: depress the brake pedal and push the DIRECT SELECT lever down past the first point of resistance.

Transmission positions

P

Park position

Only shift the transmission into position **P** when the vehicle is stationary (▷ page 138). The parking lock should not be used as a brake when parking. Always apply the parking brake in addition to the parking lock in order to secure the vehicle.

If the vehicle electronics are malfunctioning, the transmission may be locked in position **P**. Have the vehicle electronics checked immediately at a qualified specialist workshop.

Park position **P** is automatically engaged if:

- you switch off the engine using the Smartkey and remove the Smartkey
- you switch off the engine using the Smartkey or using the Start/Stop button and open the driver's door or front-passenger door
- the driver's door is opened when the vehicle is stationary or driving at very low speed and the transmission is in position **D** or **R**

R

Reverse gear

Only shift the transmission into position **R** when the vehicle is stationary.

N

Neutral

Do not shift the transmission to **N** while driving. Otherwise, the automatic transmission could be damaged.

No power is transmitted from the engine to the drive wheels.

Releasing the brakes will allow you to move the vehicle freely, e.g. to push it or tow it.

If ESP® is deactivated or faulty: shift the transmission only to position **N** if the vehicle is in danger of skidding, e.g. on icy roads.

If you switch the engine off with the transmission in position **R** or **D**, the automatic transmission shifts to **N** automatically.

! Rolling in neutral **N** can damage the drive train.

D

Drive

The automatic transmission changes gear automatically. All forward gears are available.

Driving tips

Changing gear

The automatic transmission shifts to the individual gears automatically when it is in transmission position **D**. This automatic gear shifting behavior is determined by:

- the selected drive program (▷ page 131)
- the position of the accelerator pedal (▷ page 130)
- the road speed

Accelerator pedal position

Your style of driving influences how the automatic transmission shifts gear:

- little throttle: early upshifts
- more throttle: late upshifts

Kickdown

Use kickdown for maximum acceleration:

- ▶ Depress the accelerator pedal beyond the pressure point.
The automatic transmission shifts to a lower gear depending on the engine speed.
- ▶ Ease off the accelerator pedal once the desired speed is reached.
The automatic transmission shifts back up.

Rocking the vehicle free

Rocking the vehicle free by shifting back and forth between transmission positions **D** and **R** can help to free a vehicle that has become stuck in mud or snow. The vehicle's engine management restricts switching between transmission positions **D** and **R** to speeds up to a maximum of 5 mph (9 km/h). To shift back and forth between transmission positions **D** and **R**, move the DIRECT SELECT lever up and down past the point of resistance.

Program selector button

The program selector button allows you to choose between different driving characteristics.



All vehicles (except vehicles with dynamic handling package or the AMG sports package)

- ▶ Press program selector button ①.
The selected drive program appears in the multifunction display.



Vehicles with dynamic handling package or the AMG sports package

- ▶ Press program selector button ①.
The selected drive program appears in the multifunction display.
- ❗ The permanent drive program **M** is available on the following vehicles:
 - Vehicles with the dynamic handling package
 - Vehicles with the AMG Sports package
 Further information about permanent drive program **M** (▷ page 133).
As well as this permanent drive program **M**, you can also activate temporary drive program **M** (▷ page 132).

| | |
|------------------|---------------------------------|
| E Economy | Comfortable, economical driving |
| S Sport | Sporty driving style |
| M Manual | Manual gear shifting |

- ❗ For further information on the automatic drive program, see (▷ page 132).
- ❗ The automatic transmission shifts to automatic drive program **E** each time the engine is started.

Steering wheel paddle shifters



In the manual drive program, you can change gears manually using steering wheel paddle shifters ① and ②.

Further information about permanent drive program **M** (▷ page 133).

Further information about temporary drive program **M** (▷ page 132).

- i** You can only change gear with the steering wheel paddle shifters when the transmission is in position **D**.

Automatic drive program

Automatic drive program **E**

Drive program **E** is characterized by the following:

- comfort-oriented engine settings.
- optimal fuel consumption resulting from the automatic transmission shifting up sooner.
- the vehicle pulling away more gently in forward and reverse gears, unless the accelerator pedal is depressed fully.
- increased sensitivity. This improves driving stability on slippery road surfaces, for example.
- the automatic transmission shifting up sooner. This results in the vehicle being driven at lower engine speeds and the wheels being less likely to spin.

Automatic drive program **S**

Drive program **S** is characterized by the following:

- sporty engine settings.
- the automatic transmission shifting up later. the fuel consumption possibly being higher as a result of the later automatic transmission shift points.

Manual drive program **M**

General notes

In this drive program, you can briefly change gear yourself by using the steering wheel paddle shifters. The transmission must be in position **D**. You can activate manual drive program **M** in the **E** and **S** automatic drive programs.

- i** As well as temporary drive program **M**, you can also activate permanent drive program **M** (▷ page 131).

Further information about permanent drive program **M** (▷ page 133).

Activating

- ▶ Shift the transmission to position **D**.
- ▶ Pull the left or right steering wheel paddle shifter (▷ page 132).
Manual drive program **M** is temporarily activated. The selected gear and **M** appear in the multifunction display.

Shifting gears

If you pull on the left or right steering wheel paddle shifter, the automatic transmission switches to manual drive program **M** for a limited amount of time. Depending on which paddle shifter is pulled, the automatic transmission immediately shifts into the next gear down or up, if permitted.

- ▶ **To shift up:** pull the right-hand steering wheel paddle shifter (▷ page 132).
The automatic transmission shifts up to the next gear.
- i** If the maximum engine speed on the currently engaged gear is reached and you continue to accelerate, the automatic transmis-

sion automatically shifts up in order to prevent engine damage.

- ▶ **To shift down:** pull on the left-hand steering wheel paddle shifter (▷ page 132). The automatic transmission shifts down to the next gear.

i If the engine exceeds the maximum engine speed when shifting down, the automatic transmission protects against engine damage by not shifting down.

i Automatic down shifting occurs when coasting.

Shift recommendation

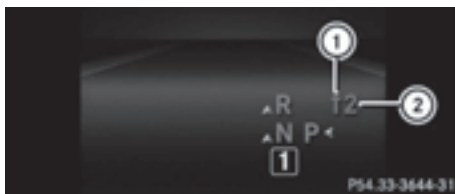

The gearshift recommendations assist you in adopting an economical driving style. The recommended gear is shown in the multifunction display.

- ▶ Shift to recommended gear ② according to gearshift recommendation ① when shown in the multifunction display of the instrument cluster.

Deactivating

If you have activated manual drive program **M**, it will remain active for a certain amount of time. Under certain conditions the minimum amount of time is extended, e.g. in the case of lateral acceleration, during an overrun phase or when driving on steep terrain.

If manual drive program **M** has been deactivated, the automatic transmission shifts into the automatic drive program that was last selected. You can also deactivate manual drive program **M** yourself:

- ▶ Pull on the right-hand steering wheel paddle shifter and hold it in place (▷ page 132).

or

- ▶ Use the DIRECT SELECT lever to switch the transmission position (▷ page 128).

or

- ▶ Use the program selector button to change the drive program (▷ page 131). Manual drive program **M** is deactivated. The automatic transmission switches into the automatic drive program that was last selected.

Manual drive program

General information

In this drive program, you can permanently change gear yourself by using the steering wheel paddle shifters. The transmission must be in position **D**.

- i** As well as this permanent drive program **M**, you can also activate temporary drive program **M** (▷ page 132).

Switching on the manual drive program

- ▶ Press the program selector button (▷ page 131) repeatedly until **M** appears in the multifunction display.

The manual drive program is only available on vehicles with the dynamic handling package or AMG sports package.

Manual drive program **M** is different from drive program **S** with regard to spontaneity, responsiveness and smoothness of gear changes.

Manual drive program **M** can be selected using the program selector button. In manual drive program **M**, you can change gear using the steering wheel paddle shifters if the transmission is in position **D**. The gear selected is shown in the multifunction display.

Upshifting

- ▶ Pull the right-hand steering wheel paddle shifter. The automatic transmission shifts up to the next gear.

Shift recommendation

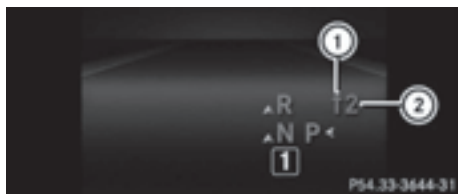

The gearshift recommendations assist you in adopting an economical driving style. The recommended gear is shown in the multifunction display.

- ▶ If corresponding gearshift recommendation ① appears in the multifunction display on the instrument cluster, pull on the right-hand steering wheel paddle shifter (▷ page 132).
The automatic transmission shifts to recommended gear ②.

Downshifting

- ▶ Pull the left-hand steering wheel paddle shifter.
The automatic transmission shifts down to the next gear.
- i** If you brake the vehicle or stop without shifting down, the automatic transmission will shift down to a gear that will allow the vehicle to accelerate or pull away again.
- i** To avoid overrevving the engine when downshifting, the automatic transmission does not shift to a lower gear if this would result in the maximum engine speed being exceeded.

Kickdown

You can also use kickdown for maximum acceleration in manual drive program **M**.

- ▶ Depress the accelerator pedal beyond the pressure point.
The automatic transmission shifts to a lower gear depending on the engine speed.

Switching off the manual drive program

- ▶ Press the program selector button (▷ page 131).

Problems with the transmission

| Problem | Possible causes/consequences and ► Solutions |
|--|--|
| The transmission has problems shifting gear. | The transmission is losing oil. ► Have the transmission checked at a qualified specialist workshop immediately. |
| The acceleration ability is deteriorating. The transmission no longer changes gear. | The transmission is in emergency mode. It is only possible to shift into second gear and reverse gear. ► Stop the vehicle. ► Shift the transmission to position P . ► Switch off the engine. ► Wait at least ten seconds before restarting the engine. ► Shift the transmission to position D or R . If D is selected, the transmission shifts into second gear; if R is selected, the transmission shifts into reverse gear. ► Have the transmission checked at a qualified specialist workshop immediately. |

Transfer case

This section is only valid for vehicles with 4-wheel drive (4MATIC). Power is always transmitted to both axles.

- ❗ Performance tests may only be carried out on a 2-axle dynamometer. The brake system or transfer case could otherwise be damaged. Contact a qualified specialist workshop for a performance test.
- ❗ If the parking brake is being tested on a brake dynamometer, the ignition must be switched off (SmartKey or Start/Stop button in position **0** or **1**), as ESP® will otherwise automatically intervene. The brake system could otherwise be damaged.
- ❗ Vehicles with 4MATIC must not be towed with either the front or the rear axle raised, as doing so will damage the transmission.

Refueling

Important safety notes

WARNING

Fuel is highly flammable. If you handle fuel incorrectly, there is a risk of fire and explosion.

You must avoid fire, open flames, creating sparks and smoking. Switch off the engine and, if applicable, the auxiliary heating before refueling.

WARNING

Fuel is poisonous and hazardous to health. There is a risk of injury.

You must make sure that fuel does not come into contact with your skin, eyes or clothing and that it is not swallowed. Do not inhale fuel vapors. Keep fuel away from children.

If you or others come into contact with fuel, observe the following:

- Wash away fuel from skin immediately using soap and water.
- If fuel comes into contact with your eyes, immediately rinse them thoroughly with clean water. Seek medical assistance without delay.
- If fuel is swallowed, seek medical assistance without delay. Do not induce vomiting.
- Immediately change out of clothing which has come into contact with fuel.

⚠ WARNING

Electrostatic buildup can create sparks and ignite fuel vapors. There is a risk of fire and explosion.

Always touch the vehicle body before opening the fuel filler flap or touching the fuel pump nozzle. Any existing electrostatic buildup is thereby discharged.

! Do not use diesel to refuel vehicles with a gasoline engine. Do not switch on the ignition if you accidentally refuel with the wrong fuel. Otherwise, the fuel will enter the fuel system. Even small amounts of the wrong fuel could result in damage to the fuel system and the engine. Notify a qualified specialist workshop and have the fuel tank and fuel lines drained completely.

! Overfilling the fuel tank could damage the fuel system.

! Take care not to spill any fuel on painted surfaces. You could otherwise damage the paintwork.

! Use a filter when refueling from a fuel can. Otherwise, the fuel lines and/or injection system could be blocked by particles from the fuel can.

Do not get into the vehicle again during the refueling process. Otherwise, electrostatic charge could build up again.

If you overfill the fuel tank, fuel could spray out when the fuel pump nozzle is removed.

i Flexible Fuel vehicles can be recognized by the **Ethanol up to E85** sticker on the inside of the fuel filler flap.

For further information on fuel and fuel quality (▷ page 309).

Refueling**General information**

Pay attention to the important safety notes (▷ page 135).

The fuel filler flap is unlocked or locked automatically when you unlock or lock the vehicle with the key or using KEYLESS-GO.

The position of the fuel filler cap is displayed  in the instrument cluster. The arrow next to the filling pump indicates the side of the vehicle.

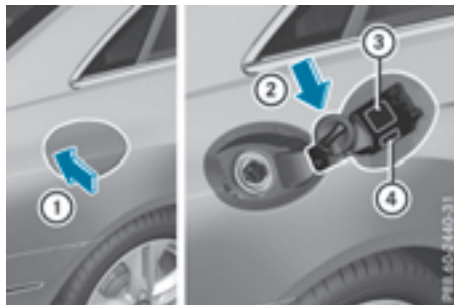
Opening the fuel filler flap

- ① To open the fuel filler flap
- ② To insert the fuel filler cap
- ③ Tire pressure table
- ④ Instruction label for fuel type to be refueled

- ▶ Switch off the engine.
- ▶ Remove the SmartKey from the ignition lock. or, on vehicles with KEYLESS-GO:
- ▶ Open the driver's door. The on-board electronics now have status **0**. This is the same as the SmartKey having been removed.
- ▶ Remove the Start/Stop button from the ignition lock (▷ page 122).
- ▶ Press the fuel filler flap in the direction of arrow ①. The fuel filler flap opens slightly.
- ▶ Open the fuel filler flap fully.
- ▶ Turn the fuel filler cap counterclockwise and remove it.
- ▶ Insert the fuel filler cap into the holder bracket on the inside of filler flap ②.
- ▶ Completely insert the filler neck of the fuel pump nozzle into the tank, hook in place and refuel.
- ▶ Only fill the tank until the pump nozzle switches off.

Do not add any more fuel after the pump stops filling for the first time. Otherwise, fuel may leak out.

Closing the fuel filler flap

- ▶ Replace the cap on the filler neck and turn clockwise until it engages audibly.
- ▶ Close the fuel filler flap.

Close the fuel filler flap before locking the vehicle. Otherwise, the locking pin of the central locking prevents the fuel filler flap from closing.

If you are driving with the fuel filler cap open, the  reserve fuel warning lamp flashes. A message appears in the multifunction display (▷ page 208).

Problems with fuel and the fuel tank

| Problem | Possible causes/consequences and ► Solutions |
|--|---|
| Fuel is leaking from the vehicle. | <p> WARNING</p> <p>The fuel line or the fuel tank is faulty. Risk of explosion or fire.</p> <ul style="list-style-type: none"> ► Apply the electric parking brake. ► Switch off the engine. ► Remove the SmartKey from the ignition lock. <p>or, on vehicles with KEYLESS-GO:</p> <ul style="list-style-type: none"> ► Open the driver's door. The on-board electronics now have status 0. This is the same as the SmartKey having been removed. ► Do not restart the engine under any circumstances. ► Consult a qualified specialist workshop. |
| The fuel filler flap cannot be opened. | <p>The fuel filler flap is not unlocked.</p> <ul style="list-style-type: none"> ► Unlock the vehicle (► page 73). |
| | <p>The SmartKey battery is discharged or nearly discharged.</p> <ul style="list-style-type: none"> ► Unlock the vehicle using the mechanical key (► page 75). |
| | <p>The fuel filler flap is unlocked, but the opening mechanism is jammed.</p> <ul style="list-style-type: none"> ► Consult a qualified specialist workshop. |

Parking

Important safety notes

 **WARNING**

Flammable material such as leaves, grass or twigs may ignite if they come into contact with hot parts of the exhaust system or exhaust gas flow. There is a risk of fire.

Park the vehicle so that no flammable materials come into contact with parts of the vehicle which are hot. Take particular care not to park on dry grassland or harvested grain fields.

 **WARNING**

If you leave children unsupervised in the vehicle, they could set it in motion by, for example:

- release the parking brake.
- shift the automatic transmission out of the parking position **P**.
- start the engine.

In addition, they may operate vehicle equipment and become trapped. There is a risk of an accident and injury.

When leaving the vehicle, always take the SmartKey with you and lock the vehicle. Never leave children unsupervised in the vehicle.

-  Always secure the vehicle correctly against rolling away. Otherwise, the vehicle or its drivetrain could be damaged.

To ensure that the vehicle is secured against rolling away unintentionally:

- the parking brake must be applied.
- the transmission must be in position **P** and the Smartkey must be removed from the ignition lock.
- the front wheels must be turned towards the curb on steep uphill or downhill gradients.

Switching off the engine

Important safety notes

WARNING

The automatic transmission switches to neutral position **N** when you switch off the engine. The vehicle may roll away. There is a risk of an accident.

After switching off the engine, always switch to parking position **P**. Prevent the parked vehicle from rolling away by applying the parking brake.

Vehicles with automatic transmission

- ▶ Apply the parking brake firmly.
- ▶ Shift the transmission to position **P**.
- ▶ **With the Smartkey:** turn the Smartkey to position **0** in the ignition lock and remove it. The immobilizer is activated.
- ▶ **With KEYLESS-GO:** press the KEYLESS-GO Start/Stop button (▷ page 122). The engine stops and all the indicator lamps in the instrument cluster go out. When the driver's door is closed, this corresponds to Smartkey position **1**. When the driver's door is open, this corresponds to Smartkey position **0**: "Smartkey removed".

If you switch the engine off with the transmission in position **R** or **D**, the automatic transmission shifts to **N** automatically.

With the Smartkey: if you then open the driver's door or the front-passenger door or remove the Smartkey from the ignition, the automatic transmission shifts to **P** automatically.

With KEYLESS-GO: if you then open the driver's or front-passenger door, the automatic transmission shifts to **P**.

If you want the automatic transmission to remain in neutral **N**, e.g. when having the vehicle cleaned in an automatic car wash with a towing system:

- ▶ **Vehicles with KEYLESS-GO:** remove the Start/Stop button from the ignition lock.
- ▶ Insert the Smartkey into the ignition lock.
- ▶ **All vehicles:** switch the ignition on.
- ▶ Depress the brake pedal and keep it depressed.
- ▶ Shift to neutral **N**.
- ▶ Release the brake pedal.
- ▶ Release the parking brake.
- ▶ Switch off the ignition and leave the Smartkey in the ignition lock.

Parking brake

WARNING

If you must brake the vehicle with the parking brake, the braking distance is considerably longer and the wheels could lock. There is an increased danger of skidding and accidents.

Only use the parking brake to brake the vehicle when the service brake is faulty. Do not apply the parking brake too firmly. If the wheels lock, release the parking brake until the wheels begin turning again.

WARNING

If you leave children unsupervised in the vehicle, they could set it in motion by, for example:

- release the parking brake.
- shift the automatic transmission out of the parking position **P**.
- start the engine.

In addition, they may operate vehicle equipment and become trapped. There is a risk of an accident and injury.

When leaving the vehicle, always take the SmartKey with you and lock the vehicle. Never leave children unsupervised in the vehicle.

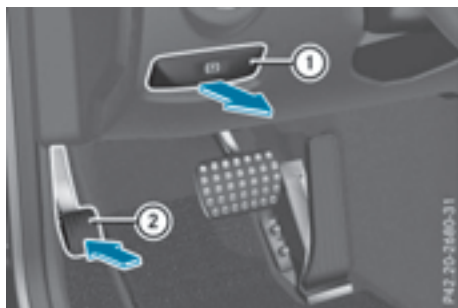

If you brake the vehicle with the parking brake, the brake lamps will not light up.

- ▶ **To apply:** depress parking brake ② firmly. When the engine is running, the **BRAKE** (USA only) or **(P)** (Canada only) indicator lamp lights up in the instrument cluster.
- ▶ **To release:** depress the brake pedal and keep it depressed.
- ▶ Pull release handle ①. When the ignition is switched on or the engine is running, the **BRAKE** (USA only) or **(P)** (Canada only) indicator lamp goes out in the instrument cluster.

Parking the vehicle for a long period

If you leave the vehicle parked for longer than four weeks, the battery may be damaged by exhaustive discharging.

If you leave the vehicle parked for longer than six weeks, the vehicle may suffer damage as a result of lack of use.

- ▶ Visit a qualified specialist workshop and seek advice.
- ▶ **i** You can obtain information about trickle chargers from a qualified specialist workshop.

Driving tips

General notes

Important safety notes

⚠ WARNING

If you switch off the ignition while driving, safety-relevant functions are only available

with limitations, or not at all. This could affect, for example, the power steering and the brake boosting effect. You will require considerably more effort to steer and brake. There is a risk of an accident.

Do not switch off the ignition while driving.

⚠ WARNING

If you operate mobile communication equipment while driving, you will be distracted from traffic conditions. You could also lose control of the vehicle. There is a risk of an accident.

Only operate this equipment when the vehicle is stationary.

Observe the legal requirements for the country in which you are driving. Some jurisdictions prohibit the driver from using a mobile phone while driving a vehicle.

If you make a call while driving, always use hands-free mode. Only operate the telephone when the traffic situation permits. If you are unsure, pull over to a safe location and stop before operating the telephone.

Bear in mind that at a speed of only 30 mph (approximately 50 km/h), the vehicle covers a distance of 44 ft (approximately 14 m) per second.

Drive sensibly – save fuel

Observe the following tips to save fuel:

- ▶ The tires should always be inflated to the recommended tire pressure.
- ▶ Remove unnecessary loads.
- ▶ Remove roof racks when they are not needed.
- ▶ Warm up the engine at low engine speeds.
- ▶ Avoid frequent acceleration or braking.
- ▶ Have all maintenance work carried out as indicated by the service intervals in the Maintenance Booklet or by the service interval display.

Fuel consumption also increases when driving in cold weather, in stop-start traffic and in hilly terrain.

Drinking and driving

WARNING

Drinking and driving and/or taking drugs and driving are very dangerous combinations. Even a small amount of alcohol or drugs can affect your reflexes, perceptions and judgment.

The possibility of a serious or even fatal accident is greatly increased when you drink or take drugs and drive.

Do not drink or take drugs and drive or allow anyone to drive who has been drinking or taking drugs.

Emission control

WARNING

Combustion engines emit poisonous exhaust gases such as carbon monoxide. Inhaling these exhaust gases leads to poisoning. There is a risk of fatal injury. Therefore never leave the engine running in enclosed spaces without sufficient ventilation.

Certain engine systems are designed to keep the level of poisonous components in exhaust fumes within legal limits.

These systems only work at peak efficiency if they are serviced exactly in accordance with the manufacturer's specifications. Always have work on the engine carried out at a qualified specialist workshop. Mercedes-Benz recommends that you use an authorized Mercedes-Benz Center for this purpose. In particular, work relevant to safety or on safety-related systems must be carried out at a qualified specialist workshop.

The engine settings must not be changed under any circumstances. Furthermore, all specific service work must be carried out at regular intervals and in accordance with the Mercedes-Benz service requirements. Details can be found in the Maintenance Booklet.

ECO display



The ECO display provides feedback on how economical your driving characteristics are. The ECO display assists you in achieving the most economical driving style for the selected settings and prevailing conditions. Your driving style can significantly influence the vehicle's consumption.

The ECO display consists of three bars:

- Acceleration
- Constant
- Coasting

The percent value is the average value of the three bars. The three bars and the mean value begin at the value of 50%. A higher percentage indicates a more economical driving style.

The ECO display does not indicate the actual fuel consumption. A fixed percentage count in the ECO display does not indicate a fixed consumption.

Apart from driving style, consumption is dependent on many factors such as, e.g.:

- load
- tire pressure
- cold start
- choice of route
- electrical consumers switched on

These factors are not included in the ECO display.

The evaluation of your driving style is carried out using the following three categories:

- **Acceleration** (evaluation of all acceleration processes):
 - The bar fills up: moderate acceleration, especially at higher speeds
 - The bar empties: sporty acceleration
- **Constant** (assessment of driving behavior at all times):
 - The bar fills up: constant speed and avoidance of unnecessary acceleration and deceleration
 - The bar empties: fluctuations in speed
- **Coasting** (assessment of all deceleration processes):
 - The bar fills up: anticipatory driving, keeping your distance and early release of the accelerator. The vehicle can coast without use of the brakes.
 - The bar empties: frequent braking

i An economical driving style specially requires driving at moderate engine speeds. To achieve a higher value in the categories **Acceleration** and **Constant**:

- observe the gearshift recommendations.
- drive in drive program **E**.

i On long journeys at a constant speed, e.g. on the highway, only the bar for **Constant** will change.

i The ECO display summarizes the driving characteristics from the start of the journey to its completion. For this reason, the bars change dynamically at the beginning of the journey. On longer journeys, there are fewer changes. For more dynamic changes, carry out a manual reset.

For further information on the ECO display, see (> page 187).

Braking

Important safety notes

WARNING

If you shift down on a slippery road surface in an attempt to increase the engine's braking effect, the drive wheels could lose their grip. There is an increased danger of skidding and accidents.

Do not shift down for additional engine braking on a slippery road surface.

Downhill gradients

! On long and steep gradients, you must reduce the load on the brakes by shifting to a lower gear in good time. This allows you to take advantage of the engine's braking effect. This helps you to avoid overheating the brakes and wearing them out excessively. When you take advantage of engine braking, a drive wheel may not turn for some time, e.g. on a slippery road surface. This could cause damage to the drive train. This type of damage is not covered by the Mercedes-Benz warranty.

Do not depress the brake pedal continuously while the vehicle is in motion, e.g. causing the brakes to rub by constantly applying light pressure to the pedal. This results in excessive and premature wear to the brake pads.

Heavy and light loads

WARNING

If you rest your foot on the brake pedal while driving, the braking system can overheat. This increases the stopping distance and can even cause the braking system to fail. There is a risk of an accident.

Never use the brake pedal as a footrest. Never depress the brake pedal and the accelerator pedal at the same time.

! Depressing the brake pedal constantly results in excessive and premature wear to the brake pads.

If the brakes have been subjected to a heavy load, do not stop the vehicle immediately, but drive on for a short while. This allows the airflow to cool the brakes more quickly.

Wet roads

If you have driven for a long time in heavy rain without braking, there may be a delayed reaction from the brakes when braking for the first time. This may also occur after the vehicle has been washed or driven through deep water.

You have to depress the brake pedal more firmly. Maintain a greater distance from the vehicle in front.

After driving on a wet road or having the vehicle washed, brake firmly while paying attention to the traffic conditions. This will warm up the brake discs, thereby drying them more quickly and protecting them against corrosion.

Limited braking performance on salt-treated roads

If you drive on salted roads, a layer of salt residue may form on the brake discs and brake pads. This can result in a significantly longer braking distance.

- In order to prevent any salt build-up, apply the brakes occasionally while paying attention to the traffic conditions.
- Carefully depress the brake pedal at the beginning and end of a journey.
- Maintain a greater distance to the vehicle ahead.

Servicing the brakes

! The brake fluid level may be too low, if:

- if the red brake warning lamp lights up in the instrument cluster and
- you hear a warning tone while the engine is running

Observe additional warning messages in the multifunction display.

The brake fluid level may be too low due to brake pad wear or leaking brake lines.

Have the brake system checked immediately. Consult a qualified specialist workshop to arrange this.

! **Vehicles with 4MATIC:** function or performance tests may only be carried out on a 2-axle dynamometer. If you wish to operate the vehicle on such a dynamometer, please consult a qualified specialist workshop in advance. You could otherwise damage the drive train or the brake system.

! **Vehicles with 4MATIC:** as the ESP® system operates automatically, the engine and the ignition must be switched off (SmartKey in position **0** or **1** in the ignition lock or Start/Stop button in position **0** or **1**) while the park-

ing brake is being tested on a brake dynamometer.

Braking maneuvers triggered automatically by ESP® may seriously damage the brake system.

! **Vehicles with 4MATIC:** as the ESP® system operates automatically, the engine and the ignition system must be switched off (SmartKey in position **0** or **1** in the ignition lock or Start/Stop button in position **0** or **1**) when:

- testing the parking brake on a brake dynamometer.
- you intend to have the vehicle towed with the front axle raised.

Braking maneuvers triggered automatically by ESP® may seriously damage the brake system.

All checks and maintenance work on the brake system must be carried out at a qualified specialist workshop.

Have brake pads installed and brake fluid replaced at a qualified specialist workshop.

If the brake system has only been subject to moderate loads, you should test the functionality of your brakes at regular intervals. To do so, press firmly on the brake pedal when driving at a high speed. This improves the grip of the brake pads.

You can find a description of Brake Assist (BAS) on (> page 63) or of BAS PLUS with Cross-Traffic Assist on (> page 63).

The braking characteristics of the vehicle can be seriously impaired if:

- brake pads other than those recommended are installed
 - the recommended brake fluid is not used
- Safe braking can no longer be guaranteed.

Driving on wet roads

Hydroplaning

If water has accumulated to a certain depth on the road surface, there is a danger of hydroplaning occurring, even if:

- you drive at low speeds.
- the tires have adequate tread depth.

For this reason, in the event of heavy rain or in conditions in which hydroplaning may occur, you must drive in the following manner:

- lower your speed.
- avoid ruts.
- avoid sudden steering movements.
- brake carefully.

Driving on flooded roads

! Do not drive through flooded areas. Check the depth of any water before driving through it. Drive slowly through standing water. Otherwise, water may enter the vehicle interior or the engine compartment. This can damage the electronic components in the engine or the automatic transmission. Water can also be drawn in by the engine's air suction nozzles and this can cause engine damage.

Winter driving

WARNING

If you shift down on a slippery road surface in an attempt to increase the engine's braking effect, the drive wheels could lose their grip. There is an increased danger of skidding and accidents.

Do not shift down for additional engine braking on a slippery road surface.

DANGER

If the exhaust pipe is blocked or adequate ventilation is not possible, poisonous gases such as carbon monoxide (CO) may enter the vehicle. This is the case, e.g. if the vehicle becomes trapped in snow. There is a risk of fatal injury.

If you leave the engine or the auxiliary heating running, make sure the exhaust pipe and area around the vehicle are clear of snow. To ensure an adequate supply of fresh air, open a window on the side of the vehicle that is not facing into the wind.

Have your vehicle winter-proofed at a qualified specialist workshop at the onset of winter.

Drive particularly carefully on slippery road surfaces. Avoid sudden acceleration, steering and braking maneuvers. Do not use the cruise control or DISTRONIC PLUS.

If the vehicle threatens to skid or cannot be stopped when moving at low speed:

► Shift the transmission to position **N**.

The outside temperature indicator is not designed to serve as an ice-warning device and is therefore unsuitable for that purpose. Changes in the outside temperature are displayed after a short delay.

Indicated temperatures just above the freezing point do not guarantee that the road surface is free of ice. The road may still be icy, especially in wooded areas or on bridges. The vehicle could skid if you fail to adapt your driving style. Always adapt your driving style and drive at a speed to suit the prevailing weather conditions.

You should pay special attention to road conditions when temperatures are around freezing point.

For more information on driving with snow chains, see (▷ page 283).

For more information on driving with summer tires, see (▷ page 283).

Observe the notes in the "Winter operation" section (▷ page 283).

Driving systems

Mercedes-Benz Intelligent Drive

Mercedes-Benz Intelligent Drive stands for innovative driver assistance and safety systems which enhance comfort and support the driver in critical situations. With these intelligent co-ordinated systems Mercedes-Benz has set a milestone on the path towards autonomous driving.

Mercedes-Benz Intelligent Drive embraces all elements of active and passive safety in one well thought out system – for the safety of the vehicle occupants and that of other road users.

Further information on driving safety systems (▷ page 62).

Cruise control

General notes

Cruise control maintains a constant road speed for you. It brakes automatically in order to avoid exceeding the set speed. On long and steep downhill gradients, especially if the vehicle is laden, you must shift to a lower gear in time. By doing so, you will make use of the braking effect of the engine. This relieves the load on the brake system and prevents the brakes from overheating and wearing too quickly.

Use cruise control only if road and traffic conditions make it appropriate to maintain a steady speed for a prolonged period. You can store any road speed above 20 mph (30 km/h).

Important safety notes

If you fail to adapt your driving style, cruise control can neither reduce the risk of an accident nor override the laws of physics. Cruise control cannot take into account the road, traffic and weather conditions. Cruise control is only an aid. You are responsible for the distance to the vehicle in front, for vehicle speed, for braking in good time and for staying in your lane.

Do not use cruise control:

- in road and traffic conditions which do not allow you to maintain a constant speed, e.g. in heavy traffic or on winding roads
- on slippery road surfaces. Braking or accelerating could cause the drive wheels to lose traction and the vehicle could then skid
- when there is poor visibility, e.g. due to fog, heavy rain or snow

If there is a change of drivers, advise the new driver of the speed stored.

Cruise control lever

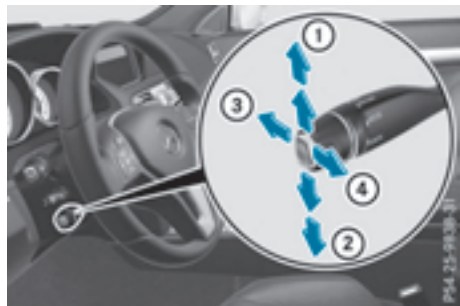

- ① To activate or increase speed
- ② To activate or reduce speed
- ③ To deactivate cruise control
- ④ To activate at the current speed/last stored speed

When you activate cruise control, the stored speed is shown in the multifunction display for five seconds.

Activation conditions

To activate cruise control, all of the following activation conditions must be fulfilled:

- the parking brake must be released.
- you are driving faster than 20 mph (30 km/h).
- ESP® must be active, but not intervening.
- the transmission must be in position **D**.

Storing and maintaining the current speed

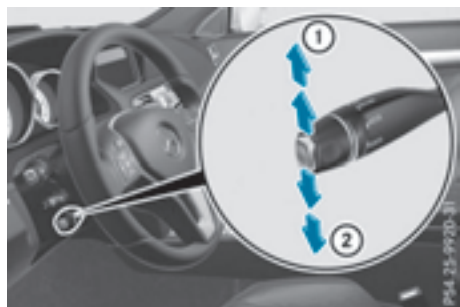

You can accept the current speed if you are driving faster than 20 mph (30 km/h).

- ▶ Accelerate the vehicle to the desired speed.
- ▶ Briefly press the cruise control lever up ① or down ②.
- ▶ Remove your foot from the accelerator pedal. Cruise control is activated. The vehicle automatically maintains the stored speed.

i Cruise control may be unable to maintain the stored speed on uphill gradients. The stored speed is resumed when the gradient evens out. Cruise control maintains the stored speed on downhill gradients by automatically applying the brakes.

Storing the current speed or calling up the last stored speed

WARNING

If you call up the stored speed and it is lower than the current speed, the vehicle decelerates. If you do not know the stored speed, the vehicle could decelerate unexpectedly. There is a risk of an accident.

Pay attention to the road and traffic conditions before calling up the stored speed. If you do not know the stored speed, store the desired speed again.



- ▶ Briefly pull the cruise control lever towards you ①.
- ▶ Remove your foot from the accelerator pedal. The first time cruise control is activated, it stores the current speed or regulates the speed of the vehicle to the previously stored speed.

Setting a speed

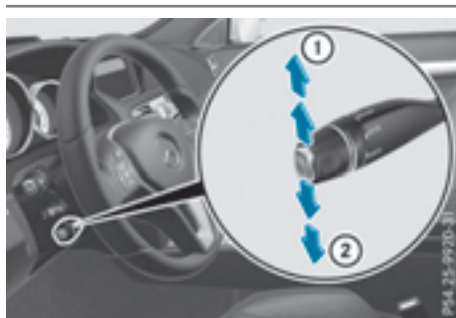

- ▶ Press the cruise control lever up ① for a higher speed or down ② for a lower speed.
- ▶ **To adjust the set speed in 1 mph increments (1 km/h increments):** briefly press the cruise control lever up ① or down ② to the pressure point. Every time the cruise control lever is pressed up ① or down ② the last speed stored is increased or reduced.
- ▶ **To adjust the set speed in 5 mph increments (10 km/h increments):** briefly press the cruise control lever up ① or down ② to the pressure point. Every time the cruise control lever is pressed up ① or down ② the last speed stored is increased or reduced.

i Cruise control is not deactivated if you depress the accelerator pedal. For example, if you accelerate briefly to overtake, cruise control adjusts the vehicle's speed to the last speed stored after you have finished overtaking.

Deactivating cruise control



There are several ways to deactivate cruise control:

► Briefly press the cruise control lever forwards ①.

or

► Brake.

Cruise control is automatically deactivated if:

- you depress the parking brake
- you are driving at less than 20 mph (30 km/h)
- ESP® intervenes or you deactivate ESP®
- you shift the transmission to position **N** while driving

If cruise control is deactivated, you will hear a warning tone. You will see the **Cruise Control Off** message in the multifunction display for approximately five seconds.

- ① When you switch off the engine, the last speed stored is cleared.

DISTRONIC PLUS

General notes

DISTRONIC PLUS regulates the speed and automatically helps you maintain the distance to the vehicle detected in front. Vehicles are detected with the aid of the radar sensor system.

DISTRONIC PLUS brakes automatically so that the set speed is not exceeded.

Change into a lower gear in good time on long and steep downhill gradients. This is especially important if the vehicle is laden. By doing so, you will make use of the braking effect of the engine. This relieves the load on the brake system and prevents the brakes from overheating and wearing too quickly.

If DISTRONIC PLUS detects that there is a risk of a collision, you will be warned visually and acoustically. DISTRONIC PLUS cannot prevent a collision without your intervention. An intermittent warning tone will then sound and the distance warning lamp will light up in the instrument cluster. Brake immediately in order to increase the distance to the vehicle in front or take evasive action provided it is safe to do so.

For DISTRONIC PLUS to assist you, the radar sensor system must be operational.

DISTRONIC PLUS operates in range between 0 mph (0 km/h) and 120 mph (200 km/h).

Do not use DISTRONIC PLUS while driving on roads with steep gradients.

As DISTRONIC PLUS transmits radar waves, it can resemble the radar detectors of the responsible authorities. You can refer to the relevant chapter in the Operator's Manual if questions are asked about this.

- ① USA only: This device has been approved by the FCC as a "Vehicular Radar System". The radar sensor is intended for use in an automotive radar system only. Removal, tampering, or altering of the device will void any warranties, and is not permitted by the FCC. Do not tamper with, alter, or use in any non-approved way.

Any unauthorized modification to this device could void the user's authority to operate the equipment.

- ① Canada only: This device complies with RSS-210 of Industry Canada. Operation is subject to the following two conditions:

1. This device may not cause harmful interference, and
2. This device must accept any interference received, including interference that may cause undesired operation of the device.

Removal, tampering, or altering of the device will void any warranties, and is not permitted. Do not tamper with, alter, or use in any non-approved way.

Any unauthorized modification to this device could void the user's authority to operate the equipment.

Important safety notes

WARNING

DISTRONIC PLUS does not react to:

- people or animals
- stationary obstacles on the road, e.g. stopped or parked vehicles
- oncoming and crossing traffic

As a result, DISTRONIC PLUS may neither give warnings nor intervene in such situations.

There is a risk of an accident.

Always pay careful attention to the traffic situation and be ready to brake.

⚠ WARNING

DISTRONIC PLUS cannot always clearly identify other road users and complex traffic situations.

In such cases, DISTRONIC PLUS may:

- give an unnecessary warning and then brake the vehicle
- neither give a warning nor intervene
- accelerate or brake unexpectedly

There is a risk of an accident.

Continue to drive carefully and be ready to brake, in particular when warned to do so by DISTRONIC PLUS.

⚠ WARNING

DISTRONIC PLUS brakes your vehicle with up to 50% of the maximum possible deceleration. If this braking force is insufficient, DISTRONIC PLUS warns you visually and audibly. There is a risk of an accident.

In such cases, apply the brakes yourself and try to take evasive action.

! If DISTRONIC PLUS or the HOLD function is activated, the vehicle brakes automatically in certain situations.

To prevent damage to the vehicle, deactivate DISTRONIC PLUS and the HOLD function in the following or other similar situations:

- when towing the vehicle
- in the car wash

If you fail to adapt your driving style, DISTRONIC PLUS can neither reduce the risk of accident nor override the laws of physics. DISTRONIC PLUS cannot take into account the road, traffic and weather conditions. DISTRONIC PLUS is only an aid. You are responsible for the distance to the vehicle in front, for vehicle speed, for braking in good time and for staying in your lane.

Do not use DISTRONIC PLUS:

- in road and traffic conditions which do not allow you to maintain a constant speed, e.g. in heavy traffic or on winding roads
- on slippery road surfaces. Braking or accelerating could cause the drive wheels to lose traction and the vehicle could then skid
- when there is poor visibility, e.g. due to fog, heavy rain or snow

DISTRONIC PLUS may not detect narrow vehicles driving in front, e.g. motorcycles, or vehicles driving on a different line.

In particular, the detection of obstacles can be impaired if:

- there is dirt on the sensors or anything else covering the sensors
- there is snow or heavy rain
- there is interference by other radar sources
- there are strong radar reflections, for example, in parking garages

If DISTRONIC PLUS no longer detects a vehicle in front, DISTRONIC PLUS may unexpectedly accelerate the vehicle to the stored speed.

This speed may:

- be too high if you are driving in a filter lane or an exit lane
- be so high in the right lane that you pass vehicles driving on the left (left-hand drive countries)
- be so high in the left lane that you pass vehicles driving on the right (right-hand drive countries)

If there is a change of drivers, advise the new driver of the speed stored.

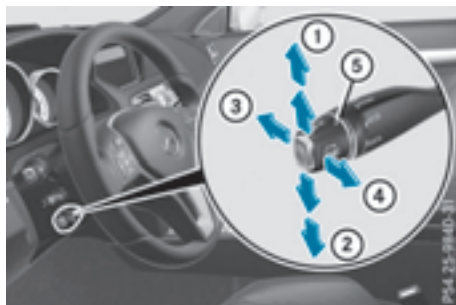
Cruise control lever

- ① To store the current speed or a higher speed
- ② To store the current speed or a lower speed

- ③ To deactivate DISTRONIC PLUS
- ④ To store the current speed or call up the last stored speed
- ⑤ To set the specified minimum distance

Activating DISTRONIC PLUS

Activation conditions

In order to activate DISTRONIC PLUS, the following conditions must be fulfilled:

- the engine must be started. It may take up to two minutes after pulling away before DISTRONIC PLUS is operational.
- the parking brake must be released.
- ESP® must be active, but not intervening.
- Active Parking Assist must not be activated.
- the transmission must be in position **D**.
- the driver's door must be closed when you shift from **P** to **D** or your seat belt must be fastened.
- the front-passenger door must be closed.
- the vehicle must not skid.

Activating

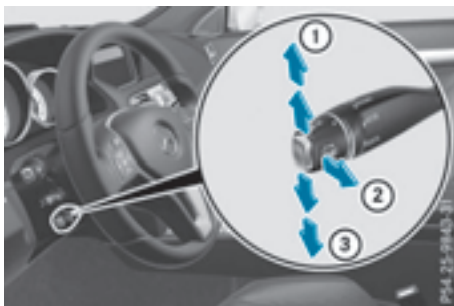

- ▶ Briefly pull the cruise control lever towards you ②, or press it up ① or down ③. DISTRONIC PLUS is selected.
- ▶ Press the cruise control lever repeatedly up ① or down ③ until the desired speed is set.
- ▶ Remove your foot from the accelerator pedal. Your vehicle adapts its speed to that of the vehicle in front, but only up to the desired stored speed.

If the vehicle in front of you is stationary, you can only activate DISTRONIC PLUS once your vehicle is stationary as well.

- ❗ If you do not fully release the accelerator pedal, the **DISTRONIC PLUS Override** message appears in the multifunction display. The set distance to a slower-moving vehicle in front will then not be maintained. You will be driving at the speed you determine by the position of the accelerator pedal.

You can also activate DISTRONIC PLUS when stationary. The lowest speed that can be set is 18 mph (30 km/h).

- ▶ Briefly pull the cruise control lever towards you ② up ① or down ③. DISTRONIC PLUS is selected.

To activate at the current speed/last stored speed

⚠ WARNING

If you call up the stored speed and it differs from the current speed, the vehicle accelerates or decelerates. If you do not know the stored speed, the vehicle could accelerate or brake unexpectedly. There is a risk of an accident.

Pay attention to the road and traffic conditions before calling up the stored speed. If you do not know the stored speed, store the desired speed again.

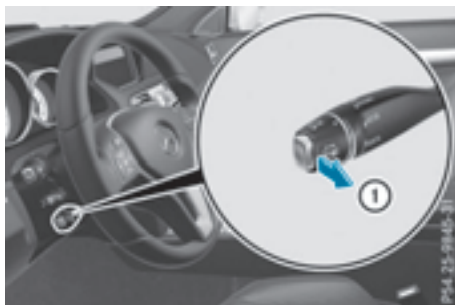

- ▶ Briefly pull the cruise control lever towards you ①.
- ▶ Remove your foot from the accelerator pedal. DISTRONIC PLUS is activated. The first time it is activated, the current speed is stored. Otherwise, it sets the vehicle cruise speed to the previously stored value.

Driving with DISTRONIC PLUS

Pulling away and driving

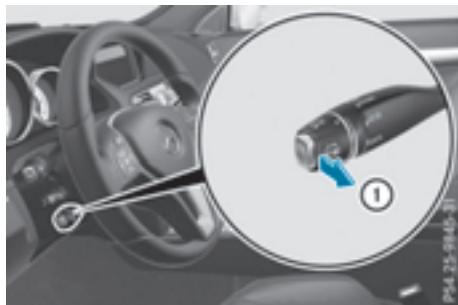

▶ If you want to pull away with **DISTRONIC PLUS**: remove your foot from the brake pedal.

▶ Briefly pull the cruise control lever towards you ①.

or

▶ Accelerate briefly.

Your vehicle pulls away and adapts its speed to that of the vehicle in front.

If no vehicle is detected in front, your vehicle accelerates to the set speed.

The vehicle can also pull away when it is facing an unidentified obstacle or is driving on a different line from another vehicle. The vehicle then brakes automatically.

If there is no vehicle in front, **DISTRONIC PLUS** operates in the same way as cruise control.

If **DISTRONIC PLUS** detects that the vehicle in front has slowed down, it brakes your vehicle. In this way, the distance you have selected is maintained.

If **DISTRONIC PLUS** detects a faster-moving vehicle in front, it increases the driving speed. However, the vehicle is only accelerated up to the speed you have stored.

Selecting the drive program

DISTRONIC Plus supports a sporty driving style when you have selected the **S** or **M** driving program (> page 131). Acceleration behind the vehicle in front or to the set speed is then noticeably more dynamic. If you have selected the **E** driving program, the vehicle accelerates more gently. This setting is recommended in stop-and-start traffic.

Changing lanes

If you change to the passing lane, **DISTRONIC PLUS** supports you when:

- you are driving faster than 45 mph (70 km/h)
- **DISTRONIC PLUS** is maintaining the distance to a vehicle in front
- you switch on the appropriate turn signal
- **DISTRONIC PLUS** does not detect a danger of collision

If these conditions are fulfilled, your vehicle is accelerated. Acceleration will be interrupted if changing lanes takes too long or if the distance between your vehicle and the vehicle in front becomes too small.

i When you change lanes, **DISTRONIC PLUS** monitors the left lane on left-hand-drive vehicles or the right lane on right-hand-drive vehicles.

Stopping

WARNING

When leaving the vehicle, even if it is braked only by **DISTRONIC PLUS**, it could roll away if:

- there is a malfunction in the system or in the voltage supply.
- **DISTRONIC PLUS** has been deactivated with the cruise control lever, e.g. by a vehicle occupant or from outside the vehicle.
- the electrical system in the engine compartment, the battery or the fuses have been tampered with.
- the battery is disconnected.
- the accelerator pedal has been depressed, e.g. by a vehicle occupant.

There is a risk of an accident.

If you wish to exit the vehicle, always turn off **DISTRONIC PLUS** and secure the vehicle against rolling away.

For further information on deactivating **DISTRONIC PLUS** (> page 152).

If **DISTRONIC PLUS** detects that the vehicle in front is stopping, it brakes your vehicle until it is stationary.

Once your vehicle is stationary, it remains stationary and you do not need to depress the brake.

Depending on the specified minimum distance, your vehicle will come to a standstill at a sufficient distance behind the vehicle in front. The specified minimum distance is set using the control on the cruise control lever.

When DISTRONIC PLUS is activated, the transmission is shifted automatically to position **P** if:

- the driver's door is open and the driver's seat belt is unfastened.
- the engine is switched off, unless it is automatically switched off by the ECO start/stop function.
- a system malfunction occurs.
- the power supply is not sufficient.

Setting a speed

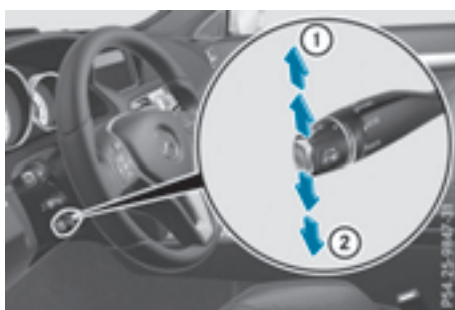

- ▶ Press the cruise control lever up ① for a higher speed or down ② for a lower speed.
- ▶ **To adjust the set speed in 1 mph increments (1 km/h increments):** briefly press the cruise control lever up ① or down ② to the pressure point. Every time the cruise control lever is pressed up ① or down ②, the last speed stored is increased or reduced.
- ▶ **To adjust the set speed in 5 mph increments (10 km/h increments):** briefly press the cruise control lever up ① or down ② to the pressure point. Every time the cruise control lever is pressed up ① or down ②, the last speed stored is increased or reduced.

i If you accelerate to overtake, DISTRONIC PLUS adjusts the vehicle's speed to the last speed stored after you have finished overtaking.

Setting a specified minimum distance

You can set the specified minimum distance for DISTRONIC PLUS by varying the time span between one and two seconds. With this function, you can set the minimum distance that DISTRONIC PLUS keeps to the vehicle in front, dependent on vehicle speed. You can see this distance in the multifunction display (▷ page 152).

- i** Make sure that you maintain a sufficient distance to the vehicle in front and comply with the minimum distance as required by law. Adjust the distance to the vehicle in front if necessary.



You can set the specified minimum distance for DISTRONIC PLUS by varying the time span between one and two seconds. With this function, you can set the minimum distance that DISTRONIC PLUS keeps to the vehicle in front, dependent on vehicle speed. You can see this distance in the multifunction display (▷ page 152).

- ▶ **To increase:** turn control ② in direction ③. DISTRONIC PLUS then maintains a greater distance between your vehicle and the vehicle in front.
- ▶ **To decrease:** turn control ② in direction ①. DISTRONIC PLUS then maintains a shorter distance between your vehicle and the vehicle in front.

DISTRONIC PLUS displays in the speedometer



Example: vehicles featuring automatic transmission with a DIRECT SELECT lever

When DISTRONIC PLUS is activated, one or two segments ② in the set speed range light up. If DISTRONIC PLUS detects a vehicle in front, segments ② between speed of the vehicle in front ① and stored speed ③ light up.

- ① For design reasons, the speed displayed in the speedometer may differ slightly from the speed set for DISTRONIC PLUS.

DISTRONIC PLUS displays in the multifunction display

General notes

In the Assistance menu (> page 191) of the on-board computer, you can select the assistance display.

Display when DISTRONIC PLUS is deactivated



- ① Vehicle in front, if detected
- ② Distance indicator, current distance to the vehicle in front
- ③ Specified minimum distance to the vehicle in front; adjustable
- ④ Own vehicle

- ▶ Select the **Assist. Graphic** function using the on-board computer (> page 191).

Display when DISTRONIC PLUS is activated



- ① Vehicle in front, if detected
- ② Specified minimum distance to the vehicle in front; adjustable
- ③ Own vehicle
- ④ DISTRONIC PLUS active (text only appears when the cruise control lever is actuated)

- ▶ Select the **Assist. Graphic** function using the on-board computer (> page 191).

- ① You will see the stored speed for about five seconds when you activate DISTRONIC PLUS.

Deactivating DISTRONIC PLUS



There are several ways to deactivate DISTRONIC PLUS:

- ▶ Briefly press the cruise control lever forwards ①.

or

- ▶ Brake, unless the vehicle is stationary

When you deactivate DISTRONIC PLUS, you will see the **DISTRONIC PLUS Off** message in the multifunction display for approximately five seconds.

- ① The last speed stored remains stored until you switch off the engine.

i DISTRONIC PLUS is not deactivated if you depress the accelerator pedal.

DISTRONIC PLUS is automatically deactivated if:

- you engage the parking brake
- ESP[®] intervenes or you deactivate ESP[®]
- the transmission is in the **P**, **R** or **N** position
- you pull the cruise control lever towards you in order to pull away and the front-passenger door is open
- the vehicle is skidding
- you activate Active Parking Assist

If DISTRONIC PLUS is deactivated, you will hear a warning tone. You will see the **DISTRONIC PLUS Off** message in the multifunction display for approximately five seconds.

Tips for driving with DISTRONIC PLUS

General notes

Pay particular attention in the following traffic situations:

- Cornering, going into and coming out of a bend
- Vehicles traveling on a different line
- Other vehicles changing lanes
- Narrow vehicles
- Obstructions and stationary vehicles
- Crossing vehicles

In such situations, brake if necessary. DISTRONIC PLUS is then deactivated.

Cornering, going into and coming out of a bend

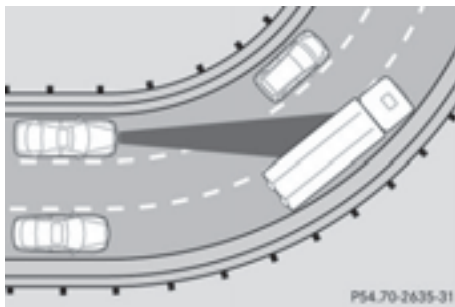

The ability of DISTRONIC PLUS to detect vehicles when cornering is limited. Your vehicle may brake unexpectedly or late.

Vehicles traveling on a different line

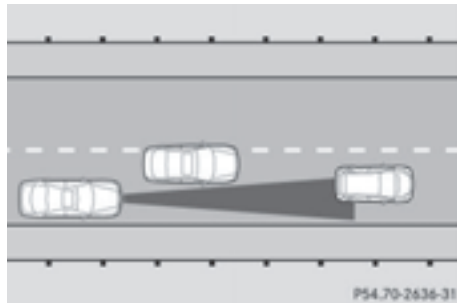

DISTRONIC PLUS may not detect vehicles traveling on a different line. The distance to the vehicle in front will be too short.

Other vehicles changing lanes

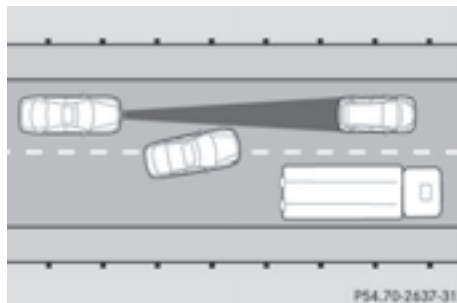

DISTRONIC PLUS has not detected the vehicle cutting in yet. The distance to this vehicle will be too short.

Narrow vehicles

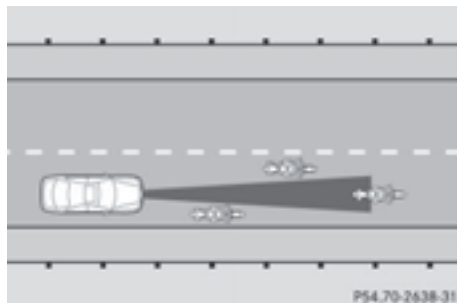

DISTRONIC PLUS has not yet detected the vehicle in front on the edge of the road, because of its narrow width. The distance to the vehicle in front will be too short.

P54.70-2635-31

P54.70-2636-31

P54.70-2637-31

P54.70-2638-31

Obstructions and stationary vehicles

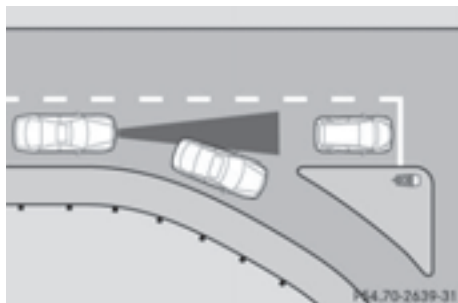

DISTRONIC PLUS does not brake for obstacles or stationary vehicles. If, for example, the detected vehicle turns a corner and reveals an obstacle or stationary vehicle, DISTRONIC PLUS will not brake for these.

Crossing vehicles

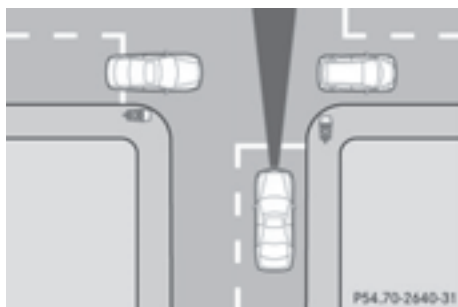

DISTRONIC PLUS may mistakenly detect vehicles that are crossing your lane. Activating DISTRONIC PLUS at traffic lights with crossing traffic, for example, could cause your vehicle to pull away unintentionally.

DISTRONIC PLUS with Steering Assist and Stop&Go Pilot

General notes



DISTRONIC PLUS with Steering Assist and Stop&Go Pilot aids you in keeping the vehicle in the center of the driving lane by means of moderate steering interventions in the speed range from 0 - 125 mph (0 - 200 km/h).

It monitors the area in front of your vehicle by means of multifunction camera ①, at the top of the windshield.

At speeds of 0 - 37 mph (0 - 60 km/h), Stop&Go Pilot focuses on the vehicle in front, taking into account lane markings, e.g. when following vehicles in a traffic jam.

At speeds of more than 37 mph (60 km/h) Steering Assist focuses on detected lane markings (left and right), and only on the vehicle in front if lane markings are missing.

If these conditions are not present, Steering Assist and Stop&Go Pilot cannot provide assistance.

DISTRONIC PLUS must be active in order for the function to be available.

Important safety notes

If you fail to adapt your driving style, DISTRONIC PLUS with Steering Assist and Stop&Go Pilot can neither reduce the risk of an accident nor override the laws of physics. It cannot take account of road, weather and traffic conditions. DISTRONIC PLUS with Steering Assist and Stop&Go Pilot is only an aid. You are responsible for the distance to the vehicle in front, for vehicle speed, for braking in good time and for staying in your lane.

DISTRONIC PLUS with Steering Assist and Stop&Go Pilot does not detect road and traffic conditions. If you are following a vehicle which is driving towards the edge of the road, your vehi-

cle could come into contact with the curb or other road boundaries. Be particularly aware of other road users, e.g. cyclists, that are directly next to your vehicle.

Obstacles such as building site huts on the lane or projecting out into the lane are not detected.

An inappropriate steering intervention, e.g. after intentionally driving over a lane marking, can be corrected at any time if you steer slightly in the opposite direction.

DISTRONIC PLUS with Steering Assist and Stop&Go Pilot cannot continuously keep your vehicle in lane. In some cases, the steering intervention is not sufficient to bring the vehicle back to the lane. In such cases, you must steer the vehicle yourself to ensure that it does not leave the lane.

The support provided by the system can be impaired if:

- there is poor visibility, e.g. due to insufficient illumination of the road, or due to snow, rain, fog or spray
- there is glare, e.g. from oncoming traffic, the sun or reflection from other vehicles (e.g. if the road surface is wet)
- the windshield is dirty, fogged up, damaged or covered, for instance by a sticker, in the vicinity of the camera
- no, or several, unclear lane markings are present for one lane, e.g. in a construction area
- the lane markings are worn away, dark or covered up, e.g. by dirt or snow
- the distance to the vehicle in front is too small and the lane markings thus cannot be detected
- the lane markings change quickly, e.g. lanes branch off, cross one another or merge
- the road is narrow and winding
- there are strong shadows cast on the road

The system is switched to passive and no longer assists you by performing steering interventions if:

- you actively change lanes
- you switch on the turn signal
- take your hands off the steering wheel or do not steer for a prolonged period of time

i After you have finished changing lanes, Steering Assist and Stop&Go Pilot are automatically active again.

DISTRONIC PLUS Steering Assist does not provide assistance:

- on very sharp corners
- when a loss of tire pressure or a defective tire has been detected and displayed

Pay attention also to the important safety notes for DISTRONIC PLUS (▷ page 147).

The steering interventions are carried out with a limited steering moment. The system requires the driver to keep his hands on the steering wheel and to steer himself.

If you do not steer yourself or if you take your hands off the steering wheel for a prolonged period of time, the system will first alert you with a visual warning. A steering wheel symbol appears in the multifunction display. If you have still not started to steer and have not taken hold of the steering wheel after five seconds at the latest, a warning tone also sounds to remind you to take control of the vehicle. Steering Assist and Stop&Go Pilot are switched to passive. DISTRONIC PLUS remains active.

Activating Steering Assist and Stop&Go Pilot

► Activate the DISTRONIC PLUS with Steering Assist and Stop&Go Pilot function using the on-board computer (▷ page 192).

The **DTR+: Steering Assistant On** message appears in the multifunction display. Steering Assist and Stop&Go Pilot are active.

Information in the multifunction display



If Steering Assist and Stop&Go Pilot are activated but not ready for a steering intervention, steering wheel symbol ① appears in gray. If the system provides you with support by means of steering interventions, symbol ① is shown in green.

Deactivating Steering Assist and Stop&Go Pilot

- ▶ Deactivate the DISTRONIC PLUS with Steering Assist and Stop&Go Pilot function using the on-board computer (▷ page 192). The **DTR+: Steering Assistant Off** message appears in the multifunction display. Steering Assist and Stop&Go Pilot are deactivated.

When DISTRONIC PLUS is deactivated or not available, Steering Assist and Stop&Go Pilot are deactivated automatically.

HOLD function

General notes

The HOLD function can assist the driver in the following situations:

- when pulling away, especially on steep slopes
- when maneuvering on steep slopes
- when waiting in traffic

The vehicle is kept stationary without the driver having to depress the brake pedal.

The braking effect is canceled and the HOLD function deactivated when you depress the accelerator pedal to pull away.

Important safety notes

WARNING

When leaving the vehicle, it can still roll away despite being braked by the HOLD function if:

- there is a malfunction in the system or in the voltage supply.
- the HOLD function has been deactivated by pressing the accelerator pedal or the brake pedal, e.g. by a vehicle occupant.
- the electrical system in the engine compartment, the battery or the fuses have been tampered with.
- the battery is disconnected

There is a risk of an accident.

If you wish to exit the vehicle, always turn off the HOLD function and secure the vehicle against rolling away.

- ❗ If DISTRONIC PLUS or the HOLD function is activated, the vehicle brakes automatically in certain situations.

To prevent damage to the vehicle, deactivate DISTRONIC PLUS and the HOLD function in the following or other similar situations:

- when towing the vehicle
- in the car wash

Activation conditions

You can activate the HOLD function if:

- the vehicle is stationary
- the engine is running or if it has been automatically switched off by the ECO start/stop function
- the driver's door is closed or your seat belt is fastened
- the parking brake is released
- the transmission is in position **D**, **R** or **N**
- DISTRONIC PLUS is deactivated

Activating the HOLD function

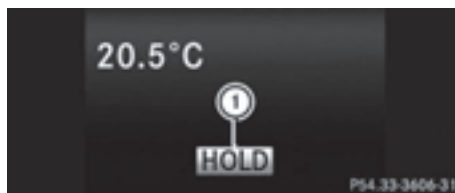

- ▶ Make sure that the activation conditions are met.
- ▶ Depress the brake pedal.
- ▶ Quickly depress the brake pedal further until **HOLD** ① appears in the multifunction display. The HOLD function is activated. You can release the brake pedal.

- ❗ If depressing the brake pedal the first time does not activate the HOLD function, wait briefly and then try again.

Deactivating the HOLD function

The HOLD function is deactivated automatically if:

- you accelerate and the transmission is in position **D** or **R**.
- you shift the transmission to position **P**.

- you depress the brake pedal again with a certain amount of pressure until **HOLD** disappears from the multifunction display.
- you activate DISTRONIC PLUS.

When the HOLD function is activated, the transmission is shifted automatically to position **P** if:

- the driver's door is open and the driver's seat belt is unfastened.
- the engine is switched off, unless it is automatically switched off by the ECO start/stop function.
- a system malfunction occurs.
- the power supply is not sufficient.

Dynamic handling package with sports mode

General notes

The most important part of the dynamic handling package with sports mode is the adjustable damping system. This automatically controls and adapts the suspension to the respective driving situation.

The calibration of the suspension depends on:

- your driving style
- the road surface conditions
- your individual selection; see the following description

Vehicles with dynamic handling package with sports mode: In addition to the drive programs **E** and **S**, there is also the manual drive program **M** (> page 132).

Sports tuning



Example: position of dynamic handling package with sports mode button

The firmer setting of the suspension tuning in sports mode ensures even better contact with the road. Select this mode when employing a sporty driving style, e.g. on winding country roads.

► Start the engine.

► **If indicator lamp ② is not lit:** press button ①.

Indicator lamp ② lights up. The sports suspension setting is selected.

❗ Your selection remains stored until you switch off the engine.

Comfort tuning



In comfort mode, the driving characteristics of your vehicle are more comfortable. Therefore, select this mode if you favor a more comfortable driving style. Select comfort mode also when driving fast on straight roads, e.g. on straight stretches of highway.

► **If indicator lamp ③ is not lit:** press button ①.

Indicator lamp ③ lights up. The comfortable suspension setting is selected.

4MATIC (permanent four-wheel drive)

If you fail to adapt your driving style, 4MATIC can neither reduce the risk of accident nor override the laws of physics. 4MATIC cannot take account of road, weather and traffic conditions. 4MATIC is only an aid. You are responsible for the distance to the vehicle in front, for vehicle speed, for braking in good time and for staying in your lane.

If a drive wheel spins due to insufficient grip:

- Only depress the accelerator pedal as far as necessary when pulling away.
- Accelerate less when driving.

! Never tow the vehicle with one axle raised. This may damage the transfer case. Damage of this sort is not covered by the Mercedes-Benz Limited Warranty. All wheels must remain either on the ground or be fully raised. Observe the instructions for towing the vehicle with all wheels in full contact with the ground.

i In wintry driving conditions, the maximum effect of 4MATIC can only be achieved if you use winter tires (M+S tires), with snow chains if necessary.

4MATIC ensures that all four wheels are permanently driven. Together with ESP®, it improves the traction of your vehicle whenever a drive wheel spins due to insufficient grip.

PARKTRONIC

Important safety notes

PARKTRONIC is an electronic parking aid with ultrasonic sensors. It monitors the area around your vehicle using six sensors in the front bumper and six sensors in the rear bumper. PARKTRONIC indicates visually and audibly the distance between your vehicle and an object. PARKTRONIC is only an aid. It is not a replacement for your attention to your immediate surroundings. You are always responsible for safe maneuvering, parking and exiting a parking space. When maneuvering, parking or pulling out of a parking space, make sure that there are no persons, animals or objects in the area in which you are maneuvering.

! When parking, pay particular attention to objects above or below the sensors, such as flower pots or trailer drawbars. PARKTRONIC does not detect such objects when they are in the immediate vicinity of the vehicle. You could damage the vehicle or the objects.

The sensors may not detect snow and other objects that absorb ultrasonic waves.

Ultrasonic sources such as an automatic car wash, the compressed-air brakes on a truck or a pneumatic drill could cause PARKTRONIC to malfunction.

PARKTRONIC may not function correctly on uneven terrain.

PARKTRONIC is activated automatically when you:

- switch on the ignition
- shift the transmission to position **D**, **R** or **N**
- release the parking brake

PARKTRONIC is deactivated at speeds above 11 mph (18 km/h). It is reactivated at lower speeds.

Range of the sensors

General notes

PARKTRONIC does not take objects into consideration that are:

- below the detection range, e.g. people, animals or objects.
- above the detection range, e.g. overhanging loads, truck overhangs or loading ramps.

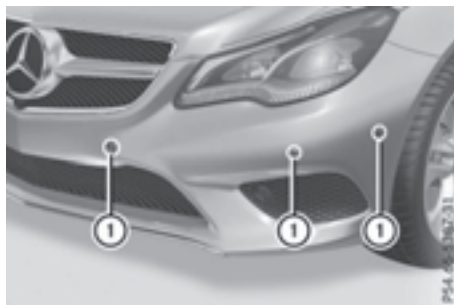

① Sensors in the front bumper, left-hand side (example)

The sensors must be free from dirt, ice or slush. They can otherwise not function correctly. Clean the sensors regularly, taking care not to scratch or damage them (> page 262).

Range

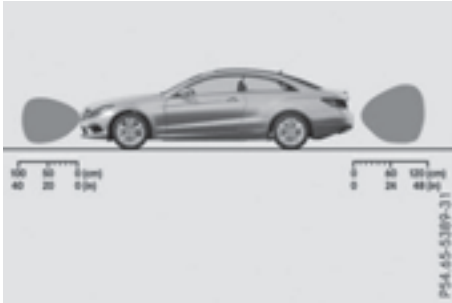

Example: side view

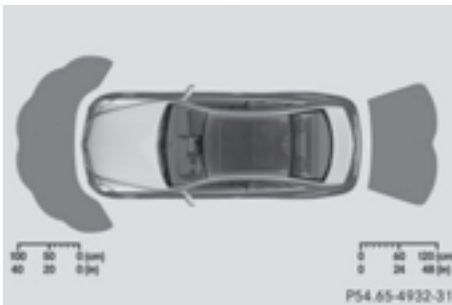

Example: top view

Front sensors

| | |
|---------|--------------------------------|
| Center | Approx. 40 in (approx. 100 cm) |
| Corners | Approx. 24 in (approx. 60 cm) |

Rear sensors

| | |
|---------|--------------------------------|
| Center | Approx. 48 in (approx. 120 cm) |
| Corners | Approx. 32 in (approx. 80 cm) |

Minimum distance

| | |
|---------|------------------------------|
| Center | Approx. 8 in (approx. 20 cm) |
| Corners | Approx. 6 in (approx. 15 cm) |

If there is an obstacle within this range, the relevant warning displays light up and a warning tone sounds. If the distance falls below the minimum, the distance may no longer be shown.

Warning displays



Warning display for the front area

- ① Segments on the left-hand side of the vehicle
- ② Segments on the right-hand side of the vehicle
- ③ Segments showing operational readiness

The warning displays show the distance between the sensors and the obstacle. The warning display for the front area is located on the dashboard above the center air vents. The warning display for the rear area is located on the headliner in the rear compartment.

The warning display for each side of the vehicle is divided into five yellow and two red segments. PARKTRONIC is operational if yellow segments showing operational readiness ③ light up.

The selected transmission position and the direction in which the vehicle is rolling determine which warning display is active when the engine is running.

| Transmission position | Warning display |
|-----------------------|--------------------------------|
| D | Front area activated |
| R or N | Rear and front areas activated |
| P | No areas activated |

One or more segments light up as the vehicle approaches an obstacle, depending on the vehicle's distance from the obstacle.

From the:

- sixth segment onwards, you will hear an intermittent warning tone for approximately two seconds.
- seventh segment onwards, you will hear a warning tone for approximately two seconds.

This indicates that you have now reached the minimum distance.

Deactivating/activating PARKTRONIC



- ① Deactivates/activates PARKTRONIC
- ② Indicator lamp

If indicator lamp ② lights up, PARKTRONIC is deactivated. Active Parking Assist is then also deactivated.

- i** PARKTRONIC is automatically activated when you turn the SmartKey to position **2** in the ignition lock.

Problems with PARKTRONIC

| Problem | Possible causes/consequences and ► Solutions |
|---|--|
| Only the red segments in the PARKTRONIC warning displays are lit. You also hear a warning tone for approximately two seconds. PARKTRONIC is then deactivated and the indicator lamp on the PARKTRONIC button lights up. | <p>PARKTRONIC has malfunctioned and has switched off.</p> <p>► If problems persist, have PARKTRONIC checked at a qualified specialist workshop.</p> |
| Only the red segments in the PARKTRONIC warning displays are lit. PARKTRONIC is then deactivated. | <p>The PARKTRONIC sensors are dirty or there is interference.</p> <p>► Clean the PARKTRONIC sensors (▷ page 262).</p> <p>► Switch the ignition back on.</p> <p>The problem may be caused by an external source of radio or ultrasound waves.</p> <p>► See if PARKTRONIC functions in a different location.</p> |

Active Parking Assist

General notes

Active Parking Assist is an electronic parking aid with ultrasound. It measures the road on both sides of the vehicle. A parking symbol indicates a suitable parking space. Active steering intervention and brake application can assist you during parking. You may also use PARKTRONIC (▷ page 158).

- ! The active braking application is only available on vehicles with automatic transmission.

Important safety notes

Active Parking Assist is merely an aid. It is not a replacement for your attention to your immediate surroundings. You are always responsible for safe maneuvering, parking and exiting a parking space. Make sure that no persons, animals or objects are in the maneuvering range. When PARKTRONIC is switched off, Active Parking Assist is also unavailable.

WARNING

While parking or pulling out of a parking space, the vehicle swings out and can drive

onto areas of the oncoming lane. This could result in a collision with another road user. There is a risk of an accident.

Pay attention to other road users. Stop the vehicle if necessary or cancel the Active Parking Assist parking procedure.

- ! If unavoidable, you should drive over obstacles such as curbs slowly and not at a sharp angle. Otherwise, you may damage the wheels or tires.

Active Parking Assist may possibly indicate parking spaces which are not suitable for parking, for example:

- where parking or stopping is prohibited
- in front of driveways or entrances and exits
- on unsuitable surfaces

Parking tips:

- On narrow roads, drive as close to the parking space as possible.
- Parking spaces that are littered or overgrown might be identified or measured incorrectly.
- Parking spaces that are partially occupied by trailer drawbars might not be identified as such or be measured incorrectly.

- Snowfall or heavy rain may lead to a parking space being measured inaccurately.
- Pay attention to the PARKTRONIC (▷ page 159) warning messages during the parking procedure.
- You can intervene in the steering procedure to correct it at any time. Active Parking Assist will then be canceled.
- When transporting a load which protrudes from your vehicle, you should not use Active Parking Assist.
- Never use Active Parking Assist when snow chains are installed.
- Make sure that the tire pressures are always correct. This has a direct influence on the parking characteristics of the vehicle.

Use Active Parking Assist for parking spaces:

- parallel or at right angles to the direction of travel
- that are on straight roads, not bends
- that are on the same level as the road, e.g. not on the sidewalk.

Detecting parking spaces

Objects located above the height range of Active Parking Assist will not be detected when the parking space is measured. These are not taken into account when the parking procedure is calculated, e.g. overhanging loads, tail sections or loading ramps of goods vehicles.

WARNING

If there are objects above the detection range:

- Active Park Assist may steer too early
- the vehicle may not stop in front of these objects

You may cause a collision as a result. There is a risk of an accident.

If objects are located above the detection range, stop and deactivate Active Parking Assist.

For further information on the detection range (▷ page 158).

Active Parking Assist does not assist you parking in spaces at right angles to the direction of travel if:

- two parking spaces are located directly next to one another
- the parking space is directly next to a low obstacle such as a low curb
- you park forwards

Active Parking Assist does not assist you parking in spaces that are parallel or at right angles to the direction of travel if:

- the parking space is on a curb
- the system reads the parking space as being blocked, for example by foliage or grass paving blocks
- the area is too small for the vehicle to maneuver into
- the parking space is bordered by an obstacle, e.g. a tree, a post or a trailer



Example: detected parking space

- ① Detected parking space on the left
- ② Parking symbol
- ③ Detected parking space on the right

Active Parking Assist is switched on automatically when driving forwards. The system is operational at speeds of up to approximately 22 mph (35 km/h). While in operation, the system independently locates and measures parking spaces on both sides of the vehicle.

Active Parking Assist will only detect parking spaces:

- parallel or at right angles to the direction of travel
- that are parallel to the direction of travel and at least 59 in (1.5 m) wide
- that are parallel to the direction of travel and at least 39.5 in (1.0 m) longer than your vehicle
- that are at right angles to the direction of travel and at least 39.5 in (1.0 m) wider than your vehicle

- i** Note that Active Parking Assist cannot measure the length of a parking space if it is at right angles to the direction of travel. You will need to judge whether your vehicle will fit into the parking space.

When driving at speeds below 19 mph (30 km/h), you will see the parking symbol as a status indicator in the instrument cluster. When a parking space has been detected, an arrow towards the right or the left also appears. By default, Active Parking Assist only displays parking spaces on the front-passenger side. Parking spaces on the driver's side are displayed as soon as the turn signal on the driver's side is activated. When parking on the driver's side, this must remain switched on until you acknowledge the use of Active Parking Assist by pressing the **OK** button on the multifunction steering wheel. The system automatically determines whether the parking space is parallel or at right angles to the direction of travel.

A parking space is displayed while you are driving past it, and until you are approximately 50 ft (15 m) away from it.

Parking

WARNING

If you leave the vehicle when it is only being braked by Active Parking Assist it could roll away if:

- there is a malfunction in the system or in the voltage supply.
- the electrical system in the engine compartment, the battery or the fuses have been tampered with.
- the battery is disconnected.
- the accelerator pedal has been depressed, e.g. by a vehicle occupant.

There is a risk of an accident.

Before leaving the vehicle, always secure it against rolling away.

- i** Vehicles with automatic transmission: When PARKTRONIC detects obstacles, Active Parking Assist brakes automatically during the parking process. You are responsible for braking in good time.

- ▶ Stop the vehicle when the parking space symbol shows the desired parking space in the instrument cluster.

- ▶ Shift the transmission to position **R**. The **Start Park Assist? Yes: OK No: ** message appears in the multifunction display.

- ▶ **To cancel the procedure:** press the **** button on the multifunction steering wheel or pull away.

or

- ▶ **To park using Active Parking Assist:** press the **OK** button on the multifunction steering wheel. The **Park Assist Active Accelerate and Brake Observe Surroundings** message appears in the multifunction display.

- ▶ Let go of the multifunction steering wheel.
- ▶ Back up the vehicle, being ready to brake at all times. When backing up, drive at a speed below approximately 6 mph (10 km/h). Otherwise Active Parking Assist will be canceled. Active Parking Assist brakes the vehicle to a standstill when the vehicle approaches the rear border of the parking space.

Maneuvering may be required in tight parking spaces.

The **Park Assist Active Select D Observe Surroundings** message appears in the multifunction display.

- ▶ Shift the transmission to position **D** while the vehicle is stationary. Active Parking Assist immediately steers in the other direction.

The **Park Assist Active Accelerate and Brake Observe Surroundings** message appears in the multifunction display.

- i** You will achieve the best results by waiting for the steering procedure to complete before pulling away.

- ▶ Drive forwards and be ready to brake at all times. Active Parking Assist brakes the vehicle to a standstill.

The **Park Assist Active Select R Observe Surroundings** message appears in the multifunction display.

Further transmission shifts may be necessary.

As soon as the parking procedure is complete, the **Park Assist Disabled** message appears in the multifunction display and you will hear a

tone. The vehicle is now parked. The vehicle is kept stationary without the driver having to depress the brake pedal. The braking effect is canceled when you depress the accelerator pedal.

Active Parking Assist no longer supports you with steering interventions and brake applications. When Active Parking Assist is finished, you must steer and brake again yourself. PARKTRONIC is still available.

- ▶ Maneuver if necessary.
- ▶ Always observe the warning messages displayed by PARKTRONIC (▷ page 159).

Parking tips:

- The way your vehicle is positioned in the parking space after parking is dependent on various factors. These include the position and shape of the vehicles parked in front and behind it and the conditions of the location. It may be the case that Active Parking Assist guides you too far into a parking space, or not far enough into it. In some cases, it may also lead you across or onto the curb. If necessary, you should cancel the parking procedure with Active Parking Assist.
- You can also select preselect transmission position **D**. The vehicle redirects and does not drive as far into the parking space. Should a gear be changed too early, the parking procedure will be canceled. A sensible parking position can no longer be achieved from this position.



Exiting a parking space

In order that Active Parking Assist can support you when exiting the parking space:

- the border of the parking space must be high enough at the front and the rear. A curb is too small, for example.
- the border of the parking space must not be too wide, as the position of the vehicle must not exceed an angle of 45° to the starting position as it is maneuvering into the parking space.
- a maneuvering distance of at least 3.3 ft (1.0 m) must be available.

- i** Vehicles with automatic transmission: If PARKTRONIC detects obstacles, Active Parking Assist brakes automatically whilst the vehicle exits the parking space. You are responsible for braking in good time.

Active Parking Assist can only assist you with exiting a parking space if you have parked the vehicle parallel to the direction of travel using Active Parking Assist.

- ▶ Start the engine.
- ▶ Release the parking brake.
- ▶ Switch on the turn signal in the direction you are pulling away.
- ▶ Shift the transmission to position **D** or **R**. The **Start Park Assist? Yes: OK No:**  message appears in the multifunction display.
- ▶ **To cancel the procedure:** press the  button on the multifunction steering wheel or pull away.

or

- ▶ **To exit a parking space using Active Parking Assist:** press the  button on the multifunction steering wheel. The **Park Assist Active Accelerate and Brake Observe Surroundings** message appears in the multifunction display.
- ▶ Let go of the multifunction steering wheel.
- ▶ Pull away, being ready to brake at all times. Do not exceed a maximum speed of approximately 6 mph (10 km/h) when exiting a parking space. Otherwise Active Parking Assist will be canceled.
- ▶ Shift the transmission to position **D** or **R** as required or according to the message while the vehicle is stationary. Active Parking Assist immediately steers in the other direction. The **Park Assist Active Accelerate and Brake Observe Surroundings** message appears in the multifunction display.

- i** You will achieve the best results by waiting for the steering procedure to complete before pulling away.

If you back up after activation, the steering wheel is moved to the straight-ahead position.

- ▶ Drive forwards and back up as instructed by the PARKTRONIC warning displays.

Once you have exited the parking space completely, the steering wheel is moved to the straight-ahead position. You hear a tone and the **Park Assist Finished** message appears in the multifunction display. You will then have to steer and merge into traffic on your own. PARKTRONIC is still available. You can take over

the steering, before the vehicle has exited the parking space completely. This is useful, for example when you recognize that it is already possible to pull out of the parking space.

Canceling Active Parking Assist

You can cancel Active Parking Assist at any time.

- ▶ Stop the movement of the multifunction steering wheel or steer yourself. Active Parking Assist will be canceled at once. The **Park Assist Canceled** message appears in the multifunction display and you hear a tone.

or

- ▶ Press the PARKTRONIC button on the center console (▷ page 160). PARKTRONIC is switched off and Active Parking Assist is immediately canceled. The **Park Assist Canceled** message appears in the multifunction display and you hear a tone.

Active Parking Assist is canceled automatically if:

- the transmission is shifted too early
- transmission position **P** is selected
- parking using Active Parking Assist is no longer possible
- you are driving faster than 6 mph (10 km/h)
- a wheel spins, ESP® intervenes or fails. In such cases the  warning lamp lights up in the instrument cluster.

A warning tone sounds. The parking symbol disappears and the multifunction display shows the **Park Assist Canceled** message.

When Active Parking Assist is canceled, you must steer and brake again yourself.

If a system malfunction occurs, the vehicle is braked to a standstill. To drive on, depress the accelerator again.

Rear view camera

General notes



Rear view camera ① is an optical parking and maneuvering aid. It shows the area behind your vehicle with guide lines in the multimedia system display.

The area behind the vehicle is displayed as a mirror image, as in the rear view mirror.

- ❗ The text shown in the multimedia system display depends on the language setting. The following are examples of rear view camera messages in the multimedia system display.

Important safety notes

The rear view camera is only an aid. It is not a replacement for your attention to your immediate surroundings. You are always responsible for safe maneuvering and parking. When maneuvering or parking, make sure that there are no persons, animals or objects in the area in which you are maneuvering.

Under the following circumstances, the rear view camera will not function, or will function in a limited manner:

- if the trunk lid is open
- in heavy rain, snow or fog
- at night or in very dark places
- if the camera is exposed to very bright light
- if the area is lit by fluorescent bulbs or LED lighting (the display may flicker)
- if there is a sudden change in temperature, e.g. when driving into a heated garage in winter

- if the camera lens is dirty or obstructed
Observe the notes on cleaning (▷ page 262)
- if the rear of your vehicle is damaged. In this event, have the camera position and setting checked at a qualified specialist workshop

The field of vision and other functions of the rear view camera may be restricted due to additional accessories on the rear of the vehicle (e.g. license plate holder, bicycle rack).

On vehicles with height-adjustable chassis, leaving the standard height can result in inaccuracies in the guide lines, depending on technical conditions.

- i** The rear view camera is protected from raindrops and dust by means of a flap. When the rear view camera is activated, this flap opens.

The flap closes again when:

- you have finished the maneuvering process
- you switch off the engine
- you open the trunk

Observe the notes on cleaning (▷ page 262).

For technical reasons, the flap may remain open briefly after the rear view camera has been deactivated.

Activating/deactivating the rear view camera

- ▶ **To activate:** make sure that the SmartKey is in position **2** in the ignition lock.
- ▶ Make sure that the **Activation by R gear** function is selected in the multimedia system (see the Digital Operator's Manual).
- ▶ Engage reverse gear.
The rear view camera flap opens. The area behind the vehicle is shown with guide lines in the multimedia system display.
The image from the rear view camera is available throughout the maneuvering process.

To deactivate: the rear view camera deactivates if you shift the transmission to **P** or after driving forwards a short distance.

Messages in the multimedia system display

The rear view camera may show a distorted view of obstacles, show them incorrectly or not at all. The rear view camera does not show objects in the following positions:

- very close to the rear bumper
- under the rear bumper
- in the area immediately above the tailgate handle

- !** Objects not at ground level may appear to be further away than they actually are, e.g.:

- the bumper of a parked vehicle
- the drawbar of a trailer
- the ball coupling of a trailer tow hitch
- the rear section of an HGV
- a slanted post

Use the guidelines only for orientation.

Approach objects no further than the bottom-most guideline.



- ① Yellow guide line at a distance of approximately 13 ft (4.0 m) from the rear of the vehicle
- ② White guide line without turning the steering wheel, vehicle width including the exterior mirrors (static)
- ③ Yellow guide line for the vehicle width including the exterior mirrors, for current steering wheel angle (dynamic)
- ④ Yellow lane marking tires at current steering wheel angle (dynamic)



- ⑤ Yellow guide line at a distance of approximately 3 ft (1.0 m) from the rear of the vehicle
- ⑥ Vehicle center axle (marker assistance)
- ⑦ Bumper
- ⑧ Red guide line at a distance of approximately 12 in (0.30 m) from the rear of the vehicle

The guide lines are shown when the transmission is in position **R**.

The distance specifications only apply to objects that are at ground level.



- ① Front warning display
- ② Additional PARKTRONIC measurement operational readiness indicator
- ③ Rear warning display

When PARKTRONIC is operational (▷ page 159), additional measurement operational readiness indicator ② appears in the multimedia system display. If the PARKTRONIC warning displays are active or light up, warning displays ① and ③ are also active or light up correspondingly.

"Reverse parking" function

Backing up straight into a parking space without turning the steering wheel



- ① White guide line without turning the steering wheel, vehicle width including the exterior mirrors (static)
- ② Yellow guide line for the vehicle width including the exterior mirrors, for current steering wheel angle (dynamic)
- ③ Yellow guide line at a distance of approximately 3 ft (1.0 m) from the rear of the vehicle
- ④ Red guide line at a distance of approximately 12 in (0.30 m) from the rear of the vehicle

- ▶ Make sure that the rear view camera is switched on (▷ page 166). The lane and the guide lines are shown.
- ▶ With the help of white guide line ①, check whether the vehicle will fit into the parking space.
- ▶ Using white guide line ① as a guide, carefully back up until you reach the end position. Red guide line ④ is then at the end of the parking space. The vehicle is almost parallel in the parking space.

Reverse perpendicular parking with the steering wheel at an angle



- ① Parking space marking
- ② Yellow guide line for the vehicle width including the exterior mirrors, for current steering wheel angle (dynamic)

- ▶ Drive past the parking space and bring the vehicle to a standstill.
- ▶ Make sure that the rear view camera is switched on (▶ page 166). The lane and the guide lines are shown.
- ▶ While the vehicle is at a standstill, turn the steering wheel in the direction of the parking space until yellow guide line ② reaches parking space marking ①.
- ▶ Keep the steering wheel in that position and back up carefully.



- ① Yellow guide line for the vehicle width including the exterior mirrors, for current steering wheel angle (dynamic)
- ▶ Stop the vehicle when it is almost exactly in front of the parking space. The white lane should be as close to parallel with the parking space marking as possible.



- ① White guide line at current steering wheel angle
- ② Parking space marking
- ▶ Turn the steering wheel to the center position while the vehicle is stationary.



- ① Red guide line at a distance of approximately 12 in (0.30 m) from the rear of the vehicle
- ② White guide line without turning the steering wheel
- ③ End of parking space
- ▶ Back up carefully until you have reached the final position. Red guide line ① is then at end of parking space ③. The vehicle is almost parallel in the parking space.

Wide-angle function



- ① Symbol for the wide-angle view function
- ② Own vehicle
- ③ PARKTRONIC warning displays

You can also use the rear view camera to select a wide-angle view.

When PARKTRONIC is operational (▷ page 159), a symbol for your own vehicle appears in the display of the multimedia system. If the PARKTRONIC warning displays are active, warning displays ③ light up in the multimedia system in yellow or red accordingly.

360° camera

General notes

The 360° camera is a system that consists of four cameras.

The system processes images from the following cameras:

- Rear view camera
- Front camera
- Two cameras in the exterior rear view mirrors

The cameras capture the immediate surroundings of the vehicle. The system supports you, e.g. when parking or if vision is restricted at an exit.

You can show pictures from the 360° camera in full-screen mode or in seven different split-screen views on the multimedia system display. A split-screen view also includes a top view of the vehicle. This view is calculated from the data supplied by the installed cameras (virtual camera).

The six split-screen views are:

- top view and picture from the rear view camera (130° viewing angle)
- top view and image from the front camera (130° viewing angle without displaying the maximum steering wheel angle)
- top view and enlarged rear view
- top view and enlarged front view
- top view and images from the rear-facing side cameras (rear wheel view)
- top view and images from the forward-facing side cameras (front wheel view)

When the function is active and you shift the transmission from **D** or **R** to **N**, the dynamic guidelines are hidden.

When you change between transmission positions **D** and **R**, you see the previously selected front or rear view.

Distances measured by PARKTRONIC will also be optically displayed:

- in split screen view as red or yellow brackets around the vehicle icon in the top view, or
- at the bottom right as red or yellow brackets around the vehicle symbol in full-screen mode

The line thickness and color of the brackets show how far the vehicle is from an object.

- yellow brackets with thin lines: PARKTRONIC is active
- yellow brackets with normal lines: an object is present in close range of the vehicle
- red line: an object is present in the immediate close range of the vehicle

Important safety notes

The 360° camera is only an aid and may show a distorted view of obstacles, show them incorrectly or not at all. The 360° camera is not a substitute for attentive driving.

You are always responsible for safe maneuvering and parking. When maneuvering or parking, make sure that there are no persons, animals or objects in the area in which you are maneuvering.

You are always responsible for safety, and must always pay attention to your surroundings when parking and maneuvering. This applies to the areas behind, in front of and beside the vehicle. You could otherwise endanger yourself and others.

The 360° camera will not function or will function in a limited manner:

- if the doors are open
- if the exterior mirrors are folded in
- if the trunk lid is open
- in heavy rain, snow or fog
- at night or in very dark places
- if the cameras are exposed to very bright light
- if the area is lit by fluorescent bulbs or LED lighting (the display may flicker)
- if there is a sudden change in temperature, e.g. when driving into a heated garage in winter
- if the camera lenses are dirty or covered
- if the vehicle components in which the cameras are installed are damaged. In this event, have the camera position and setting checked at a qualified specialist workshop

Do not use the 360° camera in this case. You can otherwise injure others or cause damage to objects or the vehicle.

Guide lines are always shown at road level.

The field of vision and other functions of the camera system may be restricted due to additional accessories on the rear of the vehicle (e.g. license plate holder, bicycle rack).

On vehicles with height-adjustable chassis, depending on technical conditions, leaving the standard height can result in:

- inaccuracies in the guide lines
- inaccuracies in the display of generated images (top view)

Activation conditions

The 360° camera image can be displayed if:



- your vehicle is equipped with a 360° camera
- the SmartKey is in position **2** in the ignition lock
- the multimedia system is switched on
- the **360° Camera** function is switched on

Switching on the 360° camera

- ▶ Press the  button in the center console for longer than two seconds. Depending on whether position **D** or **R** is engaged, the following is shown:

- a split screen with top view and the image from the front camera or
- a split screen with top view and the image from the rear view camera

or

- ▶ Press the  button in the center console. The vehicle menu is displayed.
- ▶ Select **360° Camera** and press  to confirm. Depending on whether position **D** or **R** is engaged, the following is shown:
 - a split screen with top view and the image from the front camera or
 - a split screen with top view and the image from the rear view camera

Activating the 360° camera using reverse gear





The 360° camera images can be automatically displayed by engaging reverse gear.

- ▶ Make sure that the SmartKey is in position **2** in the ignition lock.
- ▶ Make sure that the **Activation by R gear** function is selected in the multimedia system (see the separate operating instructions).
- ▶ **To show the 360° camera image:** engage reverse gear.

The area behind the vehicle is shown in the multimedia system display in split-screen mode. You see the top view of the vehicle and the image from the rear view camera.

Selecting the split-screen and full screen displays

Switching between split screen views

- ▶ To switch to the line with the vehicle icons: slide  the controller.
- ▶ To select one of the vehicle icons: turn  the controller.
- ▶ **To switch to 180° View:** turn  the controller to select **180° View** and press  to confirm.

i The **180° View** option is only available in the following views:

- Top view with picture from the rear view camera
- Top view with picture from the front camera

Messages in the multimedia system display

Important safety notes

The system may show a distorted view of obstacles or show them incorrectly or not at all. Obstacles are not shown by the system in the following locations:

- under the front and rear bumpers
- very close to the front and rear bumpers
- in close range above the handle on the trunk lid
- very close to the exterior mirrors
- in the transitional areas between the various cameras in the virtual top view

! Objects not at ground level may appear to be further away than they actually are, e.g.:

- the bumper of a parked vehicle
- the drawbar of a trailer
- the ball coupling of a trailer tow hitch
- the rear section of an HGV
- a slanted post

Use the guidelines only for orientation.

Approach objects no further than the bottom-most guideline.

Top view with picture from the rear view camera

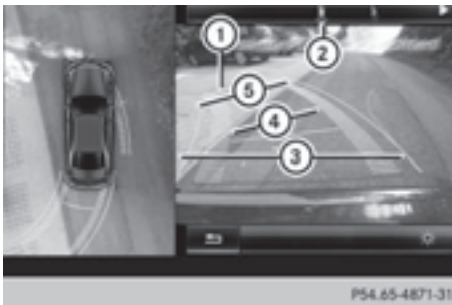

- ① Yellow guide line at a distance of approximately 13 ft (4 m) from the rear of the vehicle
- ② Symbol for the split screen setting with top view and rear view camera image
- ③ Guide line for the maximum steering angle

- ④ Yellow lane marking tires at current steering wheel angle (dynamic)
- ⑤ Yellow guide line for the vehicle width including the exterior mirrors, for current steering wheel angle (dynamic)



- ⑥ Vehicle center axle (marker assistance)
- ⑦ Yellow guide line at a distance of approximately 3 ft (1 m) from the rear of the vehicle
- ⑧ Bumper
- ⑨ Red guide line at a distance of approximately 12 in (0.3 m) from the rear of the vehicle

The guide lines are shown when the transmission is in position **R**.

The distance specifications only apply to objects that are at ground level.

Top view with picture from the front camera



- ① Symbol for the split screen setting with top view and front camera image
- ② Yellow guide line at a distance of approximately 13 ft (4 m) from the front of the vehicle
- ③ Yellow guide line for the vehicle width including the exterior mirrors, for current steering wheel angle (dynamic)
- ④ Yellow lane marking tires at current steering wheel angle (dynamic)

- ⑤ Red guide line at a distance of approximately 12 in (0.3 m) from the front of the vehicle
- ⑥ Yellow guide line at a distance of approximately 3 ft (1 m) from the front of the vehicle

Top view and enlarged rear view



- ① Symbol for the split screen setting with top view and rear view camera image enlarged
- ② Red guide line at a distance of approximately 12 in (0.3 m) from the rear of the vehicle

This view assists you in estimating the distance to the vehicle behind you.

- i** This setting can also be selected as an enlarged front view.

Top view with image from the side cameras

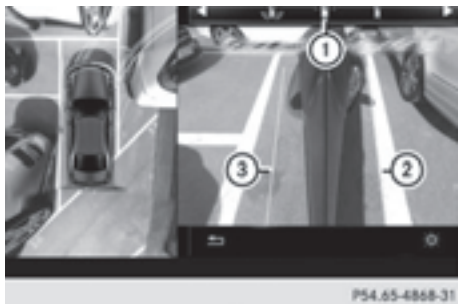

- ① Symbol for the top view and forward-facing side camera setting
- ② Yellow guide line for the vehicle width including the exterior mirrors (right side of vehicle)
- ③ Yellow guide line for the vehicle width including the exterior mirrors (left side of vehicle)

- i** You can also select the side camera setting for the rear-facing view.

180° view





- ① Symbol for the full screen setting with rear view camera image
- ② Own vehicle
- ③ PARKTRONIC warning displays
- i** 180° view can also be selected as front view.

Select this view when you are driving out of an exit and the view of crossing traffic is restricted, for example.

Exiting 360° camera display mode

The 360° camera display is stopped

- when you select transmission position **P**, or
- when you are driving at moderate speeds

The previous display appears on the multimedia system display. You can also switch the display by selecting the  symbol in the display and pressing  the controller to confirm.

ATTENTION ASSIST

General notes

ATTENTION ASSIST helps you during long, monotonous journeys, such as on highways. It is active in the 37 mph (60 km/h) to 125 mph (200 km/h) range. If ATTENTION ASSIST detects typical indicators of fatigue or increasing lapses in concentration on the part of the driver, it suggests taking a break.

Important safety notes

ATTENTION ASSIST is only an aid. It might not always recognize fatigue or increasing inattentiveness in time or fail to recognize them at all. The system is not a substitute for a well-rested and attentive driver.

The functionality of ATTENTION ASSIST is restricted and warnings may be delayed or not occur at all:

- if the length of the journey is less than approximately 30 minutes
- if the road condition is poor, e.g. if the surface is uneven or if there are potholes
- if there is a strong side wind
- if you have adopted a sporty driving style with high cornering speeds or high rates of acceleration
- if you are predominantly driving at a speed below 37 mph (60 km/h) or above 124 mph (200 km/h)
- if you are driving with the DISTRONIC PLUS Steering Assist activated
- if the time has been set incorrectly
- in active driving situations, such as when you change lanes or change your speed

The attention level evaluation is deleted and restarts when the journey is continued, if:

- you switch off the engine
- you take off your seat belt and open the driver's door, e.g. for a change of drivers or to take a break

Displaying the attention level

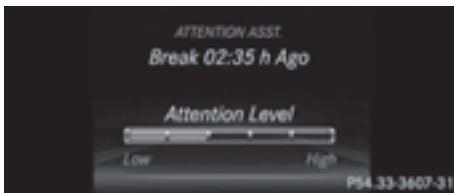

You can have current status information displayed in the assistance menu (> page 191) of the on-board computer.

- ▶ Select the Assistance display for ATTENTION ASSIST using the on-board computer (> page 191).

The following information is displayed:

- length of the journey since the last break.
- the attention level determined by ATTENTION ASSIST, displayed in a bar display in five levels from high to low.
- if ATTENTION ASSIST is unable to calculate the attention level and cannot output a warning, the **System Suspended** message appears. The bar display then changes the display, e.g. if you are driving at a speed below 37 mph (60 km/h) or above 124 mph (200 km/h).

Activating ATTENTION ASSIST

- ▶ Activate ATTENTION ASSIST using the on-board computer (> page 192).

The system determines the attention level of the driver depending on the setting selected:

Standard selected: the sensitivity with which the system determines the attention level is set to normal.

Sensitive selected: the sensitivity is set higher. The attention level detected by Attention Assist is adapted accordingly and the driver is warned earlier.

When ATTENTION ASSIST is deactivated, the  symbol and OFF appear in the multifunction display in the assistance display when the engine is running.

When ATTENTION ASSIST has been deactivated, it is automatically reactivated after the engine has been stopped. The sensitivity selected corresponds to the last selection activated (standard/sensitive).

Warning in the multifunction display

If fatigue or increasing lapses in concentration are detected, a warning appears in the multifunction display: **Attention Assist: Take a Break!**

In addition to the message shown in the multifunction display, you will then hear a warning tone.

- ▶ If necessary, take a break.
- ▶ Confirm the message by pressing the  button on the steering wheel.

On long journeys, take regular breaks in good time to allow yourself to rest. If you do not take a break, you will be warned again after 15 minutes at the earliest. This will only happen

if ATTENTION ASSIST still detects typical indicators of fatigue or increasing lapses in concentration.

Vehicles with COMAND: if a warning is output in the multifunction display, a service station search is performed in the multimedia system. You can select a service station and navigation to this service station will then begin. This function can be activated and deactivated in the multimedia system.

Traffic Sign Assist

General notes

Traffic Sign Assist displays the maximum speed permitted to the driver in the instrument cluster. The data stored in the navigation system and general traffic regulations are used to determine the current speed limit.

As Traffic Sign Assist is a map-based system, traffic signs put up temporarily (e.g. near roadworks) are not detected.

If a traffic sign that is relevant to your vehicle is passed, the display of the speed limits is updated.

Traffic signs with a restriction indicated by an additional sign (e.g. in wet conditions) are also shown.

The traffic signs are only displayed with the restrictions if:

- the regulation must be observed with the restriction, or
- Traffic Sign Assist is unable to determine whether the restriction applies

If Traffic Sign Assist is unable to determine a maximum permitted speed from any of the available sources, no speed limit is displayed in the instrument cluster either.



Traffic Sign Assist is not available in all countries. In this case, symbol ① is shown in the assistance graphic display (▷ page 191).

Important safety notes

Traffic Sign Assist is only an aid and is not always able to correctly display speed limits. Traffic signs always have priority over the Traffic Sign Assist display.

The system may be either functionally impaired or temporarily unavailable if the information in the digital street map of the navigation system is incorrect or out of date.

Instrument cluster display

Displaying the assistance graphic

- ▶ Call up the assistance graphics display function using the on-board computer (▷ page 191).
- ▶ Select the Traffic Sign Assist display. Detected traffic signs are displayed in the instrument cluster.

Speed limit with unknown restriction



- ① Maximum permitted speed
- ② Maximum permitted speed for vehicles for which the restriction in the additional sign is relevant
- ③ Additional sign for unknown restriction

A maximum permitted speed of 100 mph (100 km/h) and a speed limit of 80 km/h (80 mph) apply with an unknown restriction.

Speed limits in wet conditions



- ① Maximum permitted speed
- ② Additional signs for wet conditions

A maximum permitted speed of 80 mph (80 km/h) applies in wet conditions and if Traffic Sign Assist has determined that the restriction must be observed.

Canceling the speed limit

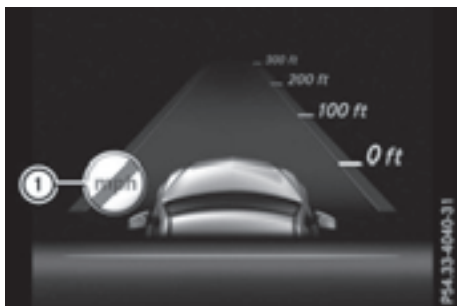

The speed limit no longer applies ①.

- i** The unit for the speed limit (km/h or mph) depends on the country in which you are driving. It is generally neither shown on the traffic sign nor on the instrument cluster but must be taken into account when observing the maximum permitted speed.

Lane Tracking package

General notes

The Lane Tracking package consists of Blind Spot Assist (▷ page 175) and Lane Keeping Assist (▷ page 177).

Blind Spot Assist

General notes

Blind Spot Assist uses a radar sensor system to monitor the areas on both sides of your vehicle. It supports you from a speed of approximately 20 mph (30 km/h). A warning display in the exterior mirrors draws your attention to vehicles detected in the monitored area. If you then switch on the corresponding turn signal to change lanes, you will also receive an optical and audible collision warning. Blind Spot Assist uses sensors in the rear bumper for monitoring purposes.

Important safety notes

⚠ WARNING

Blind Spot Assist does not react to:

- vehicles overtaken too closely on the side, placing them in the blind spot area
- vehicles which approach with a large speed differential and overtake your vehicle

As a result, Blind Spot Assist may not give warnings in such situations. There is a risk of an accident.

Always observe the traffic conditions carefully, and maintain a safe lateral distance.

Blind Spot Assist is only an aid. It may fail to detect some vehicles and is no substitute for attentive driving. Always ensure that there is sufficient distance to the side for other road users and obstacles.

- i** USA only:

This device has been approved by the FCC as a "Vehicular Radar System". The radar sensor is intended for use in an automotive radar system only. Removing, tampering with, or altering the device will void any warranties, and is not permitted by the FCC. Do not tamper with, alter, or use in any non-approved way.

Any unauthorized modification to this device could void the user's authority to operate the equipment.

Monitoring range of the sensors

In particular, the detection of obstacles can be impaired if:

- there is dirt on the sensors or anything else covering the sensors
- there is poor visibility, e.g. due to fog, heavy rain, snow or spray
- there are narrow vehicles, e.g. motorcycles or bicycles
- the road has very wide lanes
- the road has narrow lanes
- you are not driving in the middle of the lane
- there are barriers or similar lane borders

Vehicles in the monitoring range are then not indicated.

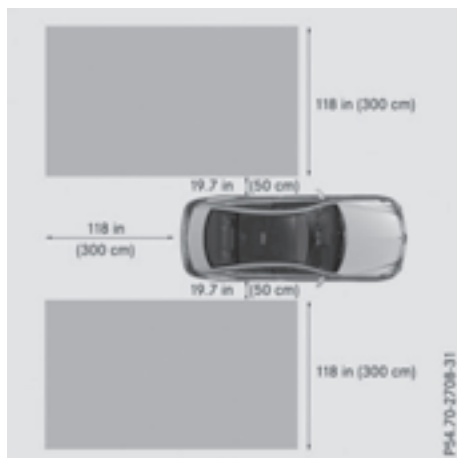

If the lanes are narrow, vehicles driving in the lane beyond the lane next to your vehicle may be indicated, especially if the vehicles are not driving in the middle of their lane. This may be the case if there are vehicles driving at the inner edge of their lanes.

Due to the nature of the system:

- warnings may be issued in error when driving close to crash barriers or similar solid lane borders.
- the warning is canceled when driving for an extended period next to long vehicles, such as trucks.

The two radar sensors for Blind Spot Assist are integrated into the sides of the rear bumper.

Make sure that the bumper is free of dirt, ice or slush in the vicinity of the sensors. The sensors must not be covered, for example by cycle racks

or overhanging loads. Following a severe impact or in the event of damage to the bumpers, have the function of the sensors checked at a qualified specialist workshop. Blind Spot Assist may otherwise not work properly.

Indicator and warning display



- ① Indicator lamp (yellow)
- Warning lamp (red)

Blind Spot Assist is not active at speeds below approximately 20 mph (30 km/h). Vehicles in the monitoring range are then not indicated.

When Blind Spot Assist is activated, indicator lamp ① in the exterior mirrors lights up yellow at speeds of up to 20 mph (30 km/h). At speeds above 20 mph (30 km/h), the indicator lamp goes out and Blind Spot Assist is operational.

If a vehicle is detected within the blind spot monitoring range at speeds above 20 mph (30 km/h), warning lamp ① on the corresponding side lights up red. This warning is always emitted when a vehicle enters the blind spot monitoring range from behind or from the side. When you overtake a vehicle, the warning only occurs if the difference in speed is less than 7 mph (12 km/h).

The yellow indicator lamp goes out if reverse gear is engaged. In this event, Blind Spot Assist is no longer active.

The brightness of the indicator or warning lamps is adjusted automatically according to the ambient light.

Collision warning

If a vehicle is detected in the monitoring range of Blind Spot Assist and you switch on the corresponding turn signal, a double warning tone sounds. Red warning lamp ① flashes. If the turn signal remains on, detected vehicles are indicated by the flashing of red warning lamp ①.

There are no further warning tones.

Switching on Blind Spot Assist

- ▶ Make sure that Blind Spot Assist (> page 193) is activated in the on-board computer.
- ▶ Turn the SmartKey to position **2** in the ignition lock.
Warning lamps ① in the exterior mirrors light up red for approximately 1.5 seconds and then turn yellow.

Lane Keeping Assist

General notes



Lane Keeping Assist monitors the area in front of your vehicle with camera ①, which is mounted at the top of the windshield. Active Lane Keeping Assist detects lane markings on the road and can warn you before you leave your lane unintentionally.

This function is available in the range between 40 mph and 120 mph (60 km/h and 200 km/h). A warning may be given if a front wheel passes over a lane marking. It will warn you by means of intermittent vibration in the steering wheel for up to 1.5 seconds.

Important safety notes

WARNING

Lane Keeping Assist may not always clearly recognize lane markings.

In this case, Lane Keeping Assist may:

- give an unnecessary warning
- not give a warning

There is a risk of an accident.

Always pay particular attention to the traffic situation and stay in lane, in particular if warned by Lane Keeping Assist.

WARNING

The Lane Keeping Assist warning does not return the vehicle to the original lane. There is a risk of an accident.

You should always steer, brake or accelerate yourself, in particular if warned by Lane Keeping Assist.

If you fail to adapt your driving style, Lane Keeping Assist can neither reduce the risk of an accident nor override the laws of physics. Lane Keeping Assist cannot take into account the road, traffic and weather conditions. Lane Keeping Assist is merely an aid. You are responsible for the distance to the vehicle in front, for vehicle speed, for braking in good time and for staying in your lane.

The Lane Keeping Assist does not keep the vehicle in the lane.

The system may be impaired or may not function if:

- there is poor visibility, e.g. due to insufficient illumination of the road, or due to snow, rain, fog or spray
- there is glare, e.g. from oncoming traffic, the sun or reflections (e.g. when the road surface is wet)
- the windshield is dirty, fogged up, damaged or covered, for instance by a sticker, in the vicinity of the camera
- there are no, several or unclear lane markings for a lane, e.g. in areas with road construction work
- the lane markings are worn away, dark or covered up, e.g. by dirt or snow
- the distance to the vehicle in front is too small and the lane markings thus cannot be detected
- the lane markings change quickly, e.g. lanes branch off, cross one another or merge
- the road is narrow and winding
- there are strong shadows cast on the road

Switching on Lane Keeping Assist

- ▶ Switch on Active Lane Keeping Assist using the on-board computer; to do so, select **Standard** or **Adaptive** (> page 193).
If you drive at speeds above 40 mph (60 km/h) and lane markings are detected, the lines in the assistance graphics display

(▷ page 191) are shown in green. Lane Keeping Assist is ready for use.

Standard

If **Standard** is selected, no warning vibration occurs if:

- you have switched on the turn signals. In this event, the warnings are suppressed for a certain period of time.
- a driving safety system intervenes, such as ABS, BAS or ESP®.

Adaptive

When **Adaptive** is selected, no warning vibration occurs if:

- you have switched on the turn signals. In this event, the warnings are suppressed for a certain period of time.
- a driving safety system intervenes, e.g. ABS, BAS or ESP®.
- you accelerate hard, e.g. kickdown.
- you brake hard.
- you steer actively, e.g. swerve to avoid an obstacle or change lanes quickly.
- you cut the corner on a sharp bend.

In order that you are warned only when necessary and in good time if you cross the lane marking, the system recognizes certain conditions and warns you accordingly.

The warning vibration occurs earlier if:

- you approach the outer lane marking on a bend.
- the road has very wide lanes, e.g. a highway.
- the system recognizes solid lane markings.

The warning vibration occurs later if:

- the road has narrow lanes.
- you cut the corner on a bend.

Active Driving Assistance package

General notes

The Active Driving Assistance package consists of DISTRONIC PLUS (▷ page 147), Active Blind Spot Assist (▷ page 178) and Active Lane Keeping Assist (▷ page 181).

Active Blind Spot Assist

General notes

Active Blind Spot Assist uses a radar sensor system, pointed toward the rear of the vehicle, to monitor the area to the sides of the vehicle which the driver is unable to see. A warning display in the exterior mirrors draws your attention to vehicles detected in the monitored area. If you then switch on the corresponding turn signal to change lane, you will also receive an optical and audible warning. If a risk of lateral collision is detected, corrective braking may help you avoid a collision. Before a course-correcting brake application, Active Blind Spot Assist evaluates the space in the direction of travel and at the sides of the vehicle. For this, Active Blind Spot Assist uses the forward-facing radar sensors.

Active Blind Spot Assist supports you from a speed of approximately 20 mph (30 km/h).

Important safety notes

Active Blind Spot Assist is only an aid and is not a substitute for attentive driving.

WARNING

Active Blind Spot Assist does not react to:

- vehicles overtaken too closely on the side, placing them in the blind spot area
- vehicles which approach with a large speed differential and overtake your vehicle

As a result, Active Blind Spot Assist may neither give warnings nor intervene in such situations. There is a risk of an accident.

Always observe the traffic conditions carefully, and maintain a safe lateral distance.

USA only:

This device has been approved by the FCC as a "Vehicular Radar System". The radar sensor is intended for use in an automotive radar system only. Removing, tampering with, or altering the device will void any warranties, and is not permitted by the FCC. Do not tamper with, alter, or use in any non-approved way.

Any unauthorized modification to this device could void the user's authority to operate the equipment.

i Canada only: This device complies with RSS-210 of Industry Canada. Operation is subject to the following two conditions:

1. This device may not cause harmful interference, and
 2. This device must accept any interference received, including interference that may cause undesired operation of the device.
- Removal, tampering, or altering of the device will void any warranties, and is not permitted. Do not tamper with, alter, or use in any non-approved way.

Any unauthorized modification to this device could void the user's authority to operate the equipment.

Radar sensors

The Active Blind Spot Assist radar sensors are integrated into the front and rear bumpers and behind a cover in the radiator trim. Make sure that the bumpers and the cover in the radiator grill are free of dirt, ice or slush. The rear sensors must not be covered, for example by cycle racks or overhanging cargo. Following a severe impact or in the event of damage to the bumpers, have the function of the radar sensors checked at a qualified specialist workshop. Active Blind Spot Assist may otherwise no longer work properly.

Monitoring area

WARNING

Active Blind Spot Assist does not detect all traffic situations and road users. There is a risk of an accident.

Always make sure that there is sufficient distance on the side for other traffic or obstacles.

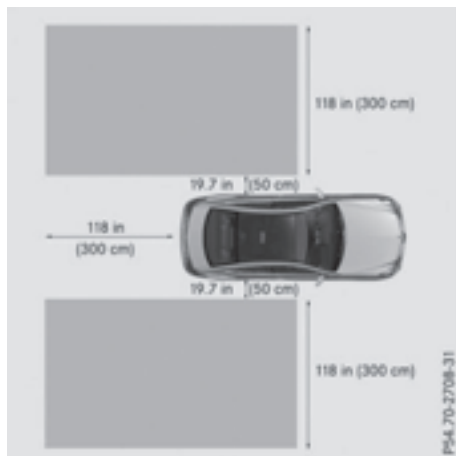

The detection of obstacles can be impaired in the case of:

- there is dirt on the sensors or anything else covering the sensors
- poor visibility, e.g. due to rain, snow or spray

Vehicles in the monitoring range are then not indicated or indicated with a delay.

Active Blind Spot Assist may not detect narrow vehicles, such as motorcycles or bicycles, or may only detect them too late.

If the lanes are narrow, vehicles driving in the lane beyond the lane next to your vehicle may be indicated, especially if the vehicles are not driving in the middle of their lane. This may be the case if there are vehicles at the edge of their lane.

Due to the nature of the system:

- warnings may be issued in error when driving close to crash barriers or similar solid lane borders.
- the warning is canceled when driving for an extended period next to long vehicles, such as trucks.

Warning display



① Warning display

Active Blind Spot Assist is not active at speeds below approximately 20 mph (30 km/h). Vehicles in the monitoring range are then not indicated.

When Active Blind Spot Assist is activated, indicator lamp ① in the exterior mirrors lights up yellow at speeds of up to 20 mph (30 km/h). At speeds above 20 mph (30 km/h), the indicator lamp goes out and Active Blind Spot Assist is operational.

If a vehicle is detected within the blind spot monitoring range at speeds above 20 mph (30 km/h), warning lamp ① on the corresponding side lights up red. This warning is always given when a vehicle enters the blind spot monitoring range from behind or from the side. When you overtake a vehicle, the warning only occurs if the difference in speed is less than 7 mph (12 km/h).

The yellow indicator lamp goes out if reverse gear is engaged. Active Blind Spot Assist is not operational.

The brightness of the warning lamps is automatically adapted to the brightness of the surroundings.

Visual and acoustic collision warning

If you switch on the turn signals to change lanes and a vehicle is detected in the side monitoring range, you receive a visual and acoustic collision warning. You then hear a double warning tone and red warning lamp ① flashes. If the turn signal remains on, detected vehicles are indicated by the flashing of red warning lamp ①. There are no further warning tones.

Course-correcting brake application

If Active Blind Spot Assist detects a risk of a lateral collision in the monitoring range, a course-correcting brake application is carried out. This is meant to assist you in avoiding a collision.

⚠ WARNING

A course-correcting brake application cannot always prevent a collision. There is a risk of an accident.

Always steer, brake or accelerate yourself, especially if Active Blind Spot Assist warns you or makes a course-correcting brake application. Always maintain a safe distance at the sides.



If a course-correcting brake application occurs, red warning lamp ① flashes in the exterior mirror and a dual warning tone sounds. In addition, display ② appears in the multifunction display underlining the danger of a side collision.

In very rare cases, the system may make an inappropriate brake application. An inappropriate course-correcting brake application may be interrupted at any time if you steer slightly in the opposite direction or accelerate, for example.

The course-correcting brake application is available in the speed range between 20 mph (30 km/h) and 120 mph (200 km/h).

Either no braking application, or a course-correcting brake application adapted to the driving situation occurs if:

- there are vehicles or obstacles, e.g. crash barriers, located on both sides of your vehicle.
- a vehicle approaches you too closely at the side.
- you have adopted a sporty driving style with high cornering speeds.
- you clearly brake or accelerate.
- a driving safety system intervenes, e.g. ESP® or PRE-SAFE® Brake.

- ESP® is switched off.
- a loss of tire pressure or a defective tire is detected.

Switching on Active Blind Spot Assist

- ▶ Make sure that Active Blind Spot Assist (▷ page 193) is activated in the on-board computer.
- ▶ Turn the SmartKey to position **2** in the ignition lock.
Warning lamps ① in the exterior mirrors light up red for approximately 1.5 seconds and then turn yellow.

Active Lane Keeping Assist

General notes



Active Lane Keeping Assist monitors the area in front of your vehicle by means of multifunction camera ① at the top of the windshield. Various different areas to the front, rear and side of your vehicle are also monitored with the aid of the radar sensor system. Active Lane Keeping Assist detects lane markings on the road and can warn you before you leave your lane unintentionally. If you do not react to the warning, a lane-correcting application of the brakes can bring the vehicle back into the original lane.

This function is available in the range between 40 mph and 120 mph (60 km/h and 200 km/h). For Active Lane Keeping Assist to assist you when driving, the radar sensor system must be operational

Important safety notes

If you fail to adapt your driving style, Active Lane Keeping Assist can neither reduce the risk of accident nor override the laws of physics. Active Lane Keeping Assist cannot take account of road and weather conditions. It may not recog-

nize traffic situations. Active Lane Keeping Assist is only an aid. You are responsible for the distance to the vehicle in front, for vehicle speed, for braking in good time and for staying in your lane.

Active Lane Keeping Assist cannot continuously keep your vehicle in its lane.

WARNING

Active Lane Keeping Assist cannot always clearly detect lane markings.

In such cases, Active Lane Keeping Assist can:

- give an unnecessary warning and then make a course-correcting brake application to the vehicle
- not give a warning or intervene

There is a risk of an accident.

Always pay particular attention to the traffic situation and keep within the lane, especially if Active Lane Keeping Assist alerts you. Terminate the intervention in a non-critical driving situation.

The system may be impaired or may not function if:

- there is poor visibility, e.g. due to insufficient illumination of the road, or due to snow, rain, fog or spray
- there is glare, e.g. from oncoming traffic, the sun or reflections (e.g. when the road surface is wet)
- the windshield is dirty, fogged up, damaged or covered, for instance by a sticker, in the vicinity of the camera
- the radar sensors in the front or rear bumpers or the radiator trim are dirty, e.g. obscured by snow
- there are no, several or unclear lane markings for a lane, e.g. in areas with road construction work
- the lane markings are worn away, dark or covered up, e.g. by dirt or snow
- the distance to the vehicle in front is too small and the lane markings thus cannot be detected
- the lane markings change quickly, e.g. lanes branch off, cross one another or merge

- the road is narrow and winding
 - there are strong shadows cast on the road
- If no vehicle is detected in the adjacent lane and broken lane markings are detected, no lane-correcting brake application is made.

Warning vibration in the steering wheel

A warning may be given if a front wheel passes over a lane marking. It will warn you by means of intermittent vibration in the steering wheel for up to 1.5 seconds.

Lane-correcting brake application

WARNING

A lane-correcting brake application cannot always bring the vehicle back into the original lane. There is a risk of an accident.

Always steer, brake or accelerate yourself, especially if Active Lane Keeping Assist warns you or makes a lane-correcting brake application.

WARNING

Active Lane Keeping Assist only detects traffic conditions or road users to a limited extent. In very rare cases, the system may make an inappropriate brake application, e.g. after intentionally driving over a solid lane marking. There is a risk of an accident.

An inappropriate brake application may be interrupted at any time if you steer slightly in the opposite direction. Always make sure that there is sufficient distance on the side for other traffic or obstacles.



If you leave your lane, under certain circumstances the vehicle will brake briefly on one side. This is meant to assist you in bringing the vehicle back to the original lane.

If a lane-correcting brake application occurs, display  appears in the multifunction display.

A lane-correcting brake application can be made after driving over a lane marking recognize as being solid or broken. Before this, a warning must be given by means of intermittent vibration in the steering wheel. In addition, a lane with lane markings on both sides must be recognized.

In the case of a broken lane marking being detected, a lane-correcting brake application can only be made if a vehicle has been detected in the adjacent lane. The following vehicles can have an influence on brake application: oncoming traffic, vehicles that are overtaking and vehicles that are driving parallel to your vehicle.

-  A further lane-correcting brake application can only occur after your vehicle has returned to the original lane.

No lane-correcting brake application occurs if:

- you clearly and actively steer, brake or accelerate.
- you cut the corner on a sharp bend.
- you have adopted a sporty driving style with high cornering speeds or high rates of acceleration.
- you have switched on the turn signal.
- a driving safety system intervenes, e.g. ESP®, PRE-SAFE® Brake or Active Blind Spot Assist.
- ESP® is switched off.
- the transmission is not in position **D**.
- an obstacle has been detected in the lane in which you are driving.
- when a loss of tire pressure or a defective tire has been detected and displayed.

There is a possibility that the Active Lane Keeping Assist could misjudge the given traffic situation. An inappropriate brake application may be interrupted at any time if you:

- steer slightly in the opposite direction.
- switch on the turn signal.
- clearly brake or accelerate.

A lane-correcting brake application is interrupted automatically if:

- a driving safety system intervenes, e.g. ESP®, PRE-SAFE® Brake or Active Blind Spot Assist.
- lane markings can no longer be recognized.

Switching on Active Lane Keeping Assist

- Switch on Active Lane Keeping Assist using the on-board computer; to do so, select **Standard** or **Adaptive** (▷ page 193).

If you drive at speeds above 40 mph (60 km/h) and lane markings are detected, the lines in the assistance graphics display (▷ page 191) are shown in green. Active Lane Keeping Assist is ready for use.

If **Standard** is selected, no warning vibration occurs if:

- you have switched on the turn signal. In this event, the warnings are suppressed for a certain period of time.
- a driving safety system intervenes, such as ABS, BAS or ESP®.

When **Adaptive** is selected, no warning vibration occurs if:

- you have switched on the turn signal. In this event, the warnings are suppressed for a certain period of time.
- a driving safety system intervenes, e.g. ABS, BAS or ESP®.
- you accelerate hard, e.g. kickdown.
- you brake hard.
- you steer actively, e.g. swerve to avoid an obstacle or change lanes quickly.
- you cut the corner on a sharp bend.

In order that you are warned only when necessary and in good time if you cross the lane marking, the system recognizes certain conditions and warns you accordingly.

The warning vibration occurs earlier if:

- you approach the outer lane marking on a bend.
- the road has very wide lanes, e.g. a highway.
- the system recognizes solid lane markings.

The warning vibration occurs later if:

- the road has narrow lanes.
- you cut the corner on a bend.

Important safety notes

WARNING

If you operate information systems and communication equipment integrated in the vehicle while driving, you will be distracted from traffic conditions. You could also lose control of the vehicle. There is a risk of an accident.

Only operate the equipment when the traffic situation permits. If you are not sure that this is possible, park the vehicle paying attention to traffic conditions and operate the equipment when the vehicle is stationary.

You must observe the legal requirements for the country in which you are currently driving when operating the on-board computer.

WARNING

If the instrument cluster has failed or malfunctioned, you may not recognize function restrictions in systems relevant to safety. The operating safety of your vehicle may be impaired. There is a risk of an accident.

Drive on carefully. Have the vehicle checked at a qualified specialist workshop immediately.

The on-board computer only shows messages or warnings from certain systems in the multifunction display. You should therefore make sure your vehicle is operating safely at all times.

If the operating safety of your vehicle is impaired, pull over as soon as it is safe to do so. Contact a qualified specialist workshop.

For an overview, see the instrument panel illustration (▷ page 33).

Displays and operation

Speedometer with segments

The segments in the speedometer indicate which speed range is available.

- Cruise control activated (▷ page 145):
The segments light up from the stored speed to the type-tested maximum speed.
- DISTRONIC PLUS activated (▷ page 147):

One or two segments in the set speed range light up.

- DISTRONIC PLUS detects a vehicle in front:
The segments between the speed of the vehicle in front and the stored speed light up.

Tachometer

-  Do not drive in the overrevving range, as this could damage the engine.

The red band in the tachometer indicates the engine's overrevving range.

The fuel supply is interrupted to protect the engine when the red band is reached.

Outside temperature display

You should pay special attention to road conditions when temperatures are around freezing point.

Bear in mind that the outside temperature display indicates the temperature measured and does not record the road temperature.

The outside temperature display is in the multifunction display (▷ page 186).

The multifunction display shows changes in the outside temperature with a delay.

Coolant temperature display

WARNING

Opening the hood when the engine is overheated or when there is a fire in the engine compartment could expose you to hot gases or other service products. There is a risk of injury.

Let an overheated engine cool down before opening the hood. If there is a fire in the engine compartment, keep the hood closed and contact the fire department.

-  A display message is shown if the coolant temperature is too high.

If the coolant temperature is over 248 °F (120 °C), do not continue driving. The engine will otherwise be damaged.

The coolant temperature gauge is in the instrument cluster on the left-hand side (▷ page 33).

Under normal operating conditions and with the specified coolant level, the coolant temperature may rise to 248 °F (120 °C).

Operating the on-board computer

Overview



- ① Multifunction display
- ② Switches on voice-operated navigation or the Voice Control System
- ③ Right control panel
- ④ Left control panel
- ⑤ Back button

► **To activate the on-board computer:** turn the SmartKey to position **1** in the ignition lock. You can control the multifunction display and the settings in the on-board computer using the buttons on the multifunction steering wheel.

Vehicles with the COMAND multimedia system: you can find further information on the Voice Control System in the separate operating instructions.

Vehicles with the Audio 20 multimedia system: you can find further information on voice-operated navigation in the manufacturer's operating instructions.

Left control panel

| | |
|----|--|
| ◀ | • Calls up the menu and menu bar |
| ▶ | |
| ▲ | Press briefly: |
| ▼ | <ul style="list-style-type: none"> • Scrolls in lists • Selects a submenu or function • In the Audio menu: selects the previous or next station, when the preset list or station list is active, or an audio track or video scene • In the Te1 (telephone) menu: switches to the phone book and selects a name or telephone number |
| ▲ | Press and hold: |
| ▼ | <ul style="list-style-type: none"> • In the Audio menu: selects a preset list or a station list in the desired frequency range, or an audio track or video scene using rapid scrolling • In the Te1 (Telephone) menu: starts rapid scrolling if the phone book is open |
| OK | <ul style="list-style-type: none"> • Confirms the selection or display message • In the Te1 (Telephone) menu: switches to the phone book and starts dialing the selected number |

Right control panel

| | |
|--------|--|
| | <ul style="list-style-type: none"> • Rejects or ends a call • Exits the telephone book/redial memory |
| | <ul style="list-style-type: none"> • Makes or accepts a call • Switches to the redial memory |
| + - | • Adjusts the volume |
| | • Mute |

Back button



Press briefly:

- Back
- Switches off voice-operated navigation or the Voice Control System
- Hides display messages or calls up the last **Trip** menu function used
- Exits the telephone book/redial memory





Press and hold:

- Calls up the standard display in the **Trip** menu



Multifunction display





- ① Text field
- ② Menu bar
- ③ Drive program
- ④ Transmission position
- ⑤ Permanent display: outside temperature or speed

- ▶ **To display menu bar ②:** press the  or  button on the steering wheel. If you do not press the buttons any longer, menu bar ② is faded out after a few seconds. Text field ① shows the selected menu or submenu as well as display messages.



Possible displays in the multifunction display:

-  Gearshift recommendation, when shifting manually (▷ page 132)
-  Active Parking Assist (▷ page 161)
- **CRUISE** Cruise control (▷ page 145)
-  Adaptive Highbeam Assist (▷ page 106)

-  **ECO** ECO start/stop function (▷ page 125)
-  **HOLD** HOLD function (▷ page 156)

Menu and submenus

Menu overview

Press the  or  button on the steering wheel to call up the menu bar and select a menu. Operating the on-board computer (▷ page 185). Depending on the equipment installed in the vehicle, you can call up the following menus:

- **Trip** menu (▷ page 186)
- **Navi** menu (navigation instructions) (▷ page 188)
- **Audio** menu (▷ page 189)
- **Tel** menu (telephone) (▷ page 190)
- **DriveAssist** menu (assistance) (▷ page 191)
- **Serv.** menu (▷ page 193)
- **Sett.** menu (settings) (▷ page 193)

The displays are controlled by the multimedia system. For this reason, the displays for the **Audio**, **Navi** and **Tel** menus may differ slightly to those in your vehicle.

Trip menu

Standard display



- ▶ Press and hold the  button on the steering wheel until the **Trip** menu with trip odometer ① and odometer ② appears.

Trip computer "From Start" or "From Reset"

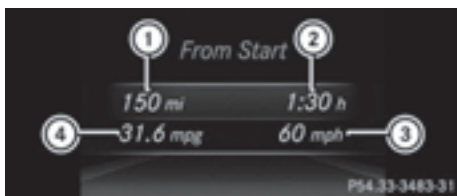

- ① Distance
- ② Driving time
- ③ Average speed
- ④ Average fuel consumption

- ▶ Press the or button on the steering wheel to select the **Trip** menu.
- ▶ Press the or button to select **From Start** or **From Reset**.

The values in the **From Start** submenu are calculated from the start of a journey whilst the values in the **From Reset** submenu are calculated from the last time the submenu was reset (▷ page 187).

In the following cases, the trip computer is automatically reset **From Start**:

- the ignition has been switched off for more than four hours.
- 999 hours have been exceeded.
- 9,999 miles have been exceeded.

When 9,999 hours or 99,999 miles have been exceeded, the trip computer is automatically reset **From Reset**.

ECO display

- ▶ Press the or button on the steering wheel to select the **Trip** menu.
- ▶ Press the or button to select **ECO DISPLAY**.

If the ignition remains switched off for longer than four hours, the ECO display will be automatically reset.

For more information on the ECO display, see (▷ page 141).

Displaying the range and current fuel consumption

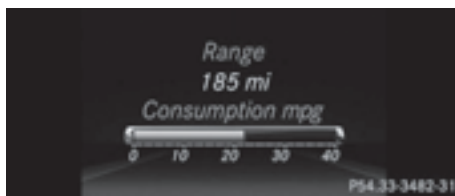

- ▶ Press the or button on the steering wheel to select the **Trip** menu.
- ▶ Press or to select the display with approximate range and the current fuel consumption.
The approximate range that can be covered depends on the fuel level and your current driving style. If there is only a small amount of fuel left in the fuel tank, a vehicle being refueled appears instead of approximate range.

Digital speedometer

- ▶ Press the or button on the steering wheel to select the **Trip** menu.
- ▶ Press the or button to select the digital speedometer.
A gearshift recommendation can also appear in the display.
Observe the information on gearshift recommendation when shifting manually (▷ page 132).

Resetting values

- ▶ Press the or button on the steering wheel to select the **Trip** menu.
- ▶ Press the or button to select the function that you wish to reset.
- ▶ Press **OK** to confirm your selection.
- ▶ Press to select **Yes** and press **OK** to confirm.

You can reset the values of the following functions:

- Trip odometer
- "From Start" trip computer
- "From Reset" trip computer
- ECO display



- i** If you reset the values in the ECO display, the values in the "From Start" trip computer are also reset. If you reset the values in the "From Start" trip computer, the values in the ECO display are also reset.

Navigation system menu

Displaying navigation instructions

In the **Navi** menu, the multifunction display shows navigation instructions.

Observe the additional information on navigation in the separate operating instructions of the multimedia system.

- ▶ Switch on the multimedia system (see separate operating instructions).
- ▶ Press the  or  button on the steering wheel to select the **Navi** menu.

Route guidance not active



- ① Direction of travel
- ② Current road

Route guidance active

No change of direction announced



- ① Distance to destination
- ② Distance to the next change of direction
- ③ Current road
- ④ "Follow the road's course" symbol

Change of direction announced without a lane recommendation



- ① Road into which the change of direction leads
- ② Distance to change of direction and visual distance display
- ③ Change-of-direction symbol

When a change of direction is announced, you will see symbol ③ for the change of direction and distance graphic ②. The distance indicator shortens towards the top of the display as you approach the point of the announced change of direction.

Change of direction announced with a lane recommendation



- ① Road into which the change of direction leads
- ② Distance to change of direction and visual distance display
- ③ Lanes not recommended
- ④ Recommended lane and new lane during a change of direction
- ⑤ Change-of-direction symbol

On multilane roads, new lane recommendations can be displayed for the next change of direction if the digital map supports this data. During the change of direction, new lanes may be added.

Lane not recommended ③: you will not be able to complete the next change of direction if you stay in this lane.

Recommended lane and new lane during a change of direction ④: in this lane you will be able to complete the next two changes of direction without changing lane.

Other status indicators of the navigation system



The navigation system displays additional information and the vehicle status.

Possible displays:

- **New Route...** or **Calculating Route**
A new route is calculated.
- **Road Not Mapped**
The vehicle position is inside the area of the digital map but the road is not recognized, e.g. newly built streets, car parks or private land.
- **No Route**
No route could be calculated to the selected destination.
- : you have reached the destination or an intermediate destination.





Audio menu

Selecting a radio station



- ① Active station list
- ② Station frequency with memory position

The menu shows station ② with station frequency or station name. The preset position is only displayed along with station ② if this has been stored.

- ▶ Switch on the multimedia system and select Radio (see the separate operating instructions).
- ▶ Press the  or  button on the steering wheel to select the **Audio** menu.
- ▶ **To select a preset list or station list:** press and briefly hold the  or  button until

the preset list or station list in the desired frequency range is shown.

- ▶ **To select a station:** briefly press  or .









- ❗ SIRIUS XM satellite radio functions like a normal radio.

For more information on radio operation, see "Satellite radio" in the separate operating instructions.

Operating an audio player or audio media









Audio data from various audio devices or media can be played, depending on the equipment installed in the vehicle.

- ▶ Switch on the multimedia system and select audio CD or MP3 mode (see the separate operating instructions).
- ▶ Press the  or  button on the steering wheel to select the **Audio** menu.
- ▶ **To select the next/previous track:** briefly press the  or  button.
- ▶ **To select a track from the track list (rapid scrolling):** press and hold the  or  button until desired track ① appears. If you press and hold  or , the rapid scrolling speed is increased. Not all audio drives or data carriers support this function. If track information is stored on the audio device or medium, the multifunction display will show the number and title of the track.

Video DVD operation



Only for vehicles with COMAND: you can use the **Audio** menu to operate video DVDs.

- ▶ Switch on the multimedia system and select video DVD (see the separate operating instructions).
- ▶ Press the  or  button on the steering wheel to select the **Audio** menu.
- ▶ **To select the next or previous scene:** briefly press the  or  button.
- ▶ **To select a scene from the scene list (rapid scrolling):** press and hold the  or  button until desired scene ① appears.

Telephone menu



Introduction

WARNING

If you operate information systems and communication equipment integrated in the vehicle while driving, you will be distracted from traffic conditions. You could also lose control of the vehicle. There is a risk of an accident.

Only operate the equipment when the traffic situation permits. If you are not sure that this is possible, park the vehicle paying attention to traffic conditions and operate the equipment when the vehicle is stationary.

When telephoning, you must observe the legal requirements for the country in which you are currently driving.

- ▶ Switch on the mobile phone (see the manufacturer's operating instructions).
- ▶ Switch on the multimedia system (see separate operating instructions).
- ▶ Establish a Bluetooth® connection to the multimedia system (see the separate operating instructions).
- ▶ Press the  or  button on the steering wheel to select the **Te1** menu.

You will see one of the following display messages in the multifunction display:

- **Phone READY** or the name of the network provider: the mobile phone has found a network and is ready to receive.
- **Phone No Service:** there is no network available or the mobile phone is searching for a network.

Accepting a call

If someone calls you when you are in the **Te1** menu, a display message appears in the multifunction display.







You can accept a call at any time regardless of the menu selected.

- ▶ Press the  button on the steering wheel to accept an incoming call.



Rejecting or ending a call

- ▶ Press the  button on the steering wheel to reject or end a call.

Selecting an entry in the phone book

- ▶ Press the  or  button on the steering wheel to select the **Te1** menu.
- ▶ Press the ,  or  button to switch to the phone book.
- ▶ Authorize access to the phone book on the phone.
- ▶ Press the  or  button to select the desired name.







or

- ▶ **To start rapid scrolling:** press and hold  or  for longer than one second. The names in the phone book are displayed quickly one after the other.

Rapid scrolling stops when you release the button or reach the end of the list.

- ▶ **If only one telephone number is stored for a name:** press the  or  button to start dialing.

or









- ▶ **If there is more than one number for a particular name:** press the  or  button to display the numbers.
- ▶ Press the  or  button to select the number you want to dial.
- ▶ Press the  or  button to start dialing.

or

- ▶ **To exit the telephone book:** press the  or  button.

Redialing

The on-board computer saves the last names or numbers dialed in the redial memory.

- ▶ Press the  or  button on the steering wheel to select the **Tel** menu.
 - ▶ Press the  button to switch to the redial memory.
 - ▶ Press the  or  button to select the desired name or number.
 - ▶ Press the  or  button to start dialing.
- or
- ▶ **To exit the redial memory:** press the  or  button.

Assistance menu





Introduction

Depending on the equipment installed in the vehicle, you have the following options in the **DriveAssist** menu:

- Displaying the assistance graphic (▷ page 191)
- Deactivating/activating ESP® (▷ page 191)
- Activating/deactivating Steering Assist and Stop&Go Pilot of DISTRONIC PLUS (▷ page 192)
- Activating/deactivating PRE-SAFE® Brake (▷ page 192)
- Activating/deactivating COLLISION PREVENTION ASSIST PLUS (▷ page 192)
- Activating/deactivating ATTENTION ASSIST (▷ page 192)
- Activating/deactivating Blind Spot Assist or Active Blind Spot Assist (▷ page 193)
- Activating/deactivating Lane Keeping Assist or Active Lane Keeping Assist (▷ page 193)

Displaying the assistance graphic



- ▶ Press the  or  button on the steering wheel to select the **DriveAssist** menu.
- ▶ Press  or  to select **Assist. Graphic**.
- ▶ Press  to confirm.

The multifunction display shows the DISTRONIC PLUS distance display in the assistance graphic.

The assistance graphic shows you the status and further information on the following driving systems or driving safety systems:

- Traffic Sign Assist (▷ page 174)
 - DISTRONIC PLUS (▷ page 147)
 - PRE-SAFE® Brake (▷ page 69)
 - COLLISION PREVENTION ASSIST PLUS (▷ page 65)
 - ATTENTION ASSIST (▷ page 172)
 - Lane Keeping Assist (▷ page 177)
 - Active Lane Keeping Assist (▷ page 181)
- ▶ Press  to display the ATTENTION ASSIST assessment.

Deactivating/activating ESP®

-  Observe the important safety notes on ESP® (▷ page 67).

WARNING







If you deactivate ESP®, ESP® no longer stabilizes the vehicle. There is an increased risk of skidding and an accident.

Only deactivate ESP® in the situations described in the following.



It may be best to deactivate ESP® in the following situations:

- when using snow chains
- in deep snow
- on sand or gravel

For further information about ESP®, see (▷ page 67).

- ▶ Start the engine.
- ▶ Press the  or  button on the steering wheel to select the **DriveAssist** menu.
- ▶ Press  or  to select **ESP**.
- ▶ Press  to confirm. The current selection appears.
- ▶ **To activate/deactivate:** press the  button again.

ESP® is deactivated if the  warning lamp in the instrument cluster lights up continuously when the engine is running.







If the  warning lamp and the  warning lamp are lit continuously, ESP® is not available due to a malfunction.

Observe the information on warning lamps (▷ page 222).

Observe the information on display messages (▷ page 198).





Activating/deactivating PRE-SAFE® Brake



PRE-SAFE® Brake is only available for vehicles with the Driving Assistance package.

- ▶ Press the  or  button on the steering wheel to select the **DriveAssist** menu.
- ▶ Press the  or  button to select **PRE-SAFE Brake**.
- ▶ Press  to confirm. The current selection appears.
- ▶ **To activate/deactivate:** press the  button again. When PRE-SAFE® Brake is deactivated, the assistance graphic shows the  symbol in the multifunction display.

For more information on PRE-SAFE® Brake, see (▷ page 69).







Activating/deactivating COLLISION PREVENTION ASSIST PLUS

- ▶ Press the  or  button on the steering wheel to select the **DriveAssist** menu.
- ▶ Press the  or  button to select **Collision Prevent..**

- ▶ Press  to confirm. The current selection appears.
- ▶ **To activate/deactivate:** press the  button again. If COLLISION PREVENTION ASSIST PLUS is deactivated, the assistance graphic shows the  symbol in the multifunction display.











For further information about COLLISION PREVENTION ASSIST PLUS, see (▷ page 65).

Activating/deactivating Steering Assist and Stop&Go Pilot

- ▶ Press the  or  button on the steering wheel to select the **DriveAssist** menu.
- ▶ Press the  or  button to select **DTR+: Steer. Asst.**
- ▶ Press  to confirm. The current selection appears.
- ▶ **To activate/deactivate:** press the  button again. When Steering Assist and Stop&Go Pilot are activated, the multifunction display shows the **DTR+: Steer. Asst. On** message.







Further information about DISTRONIC PLUS with Steering Assist and Stop&Go Pilot (▷ page 154).

Activating/deactivating ATTENTION ASSIST

- ▶ Press the  or  button on the steering wheel to select the **DriveAssist** menu.
- ▶ Press the  or  button to select **Attention Assist**.
- ▶ Press  to confirm your selection. The current selection appears.
- ▶ Press  to confirm.
- ▶ Press the  or  button to set **Off**, **Standard** or **Sensitive**.
- ▶ Press the  button to save the setting. When ATTENTION ASSIST is deactivated, the  symbol appears in the multifunction display in the assistance graphics display.

For further information about ATTENTION ASSIST, see (▷ page 172).









Activating/deactivating Blind Spot Assist

- ▶ Press the  or  button on the steering wheel to select the **DriveAssist** menu.
- ▶ Press the  or  button to select **Blind Spot Assist**.
- ▶ Press the  button.
The current selection appears.
- ▶ **To activate/deactivate:** press the  button again.

For further information about Blind Spot Assist, see (▷ page 175).

For further information about Active Blind Spot Assist, see (▷ page 178).

Activating/deactivating Lane Keeping Assist

- ▶ Press the  or  button on the steering wheel to select the **DriveAssist** menu.
- ▶ Press the  or  button to select **Lane Keep. Assist**.
- ▶ Press the  button.
The current selection appears.
- ▶ Press  to confirm.
- ▶ Press the  or  button to set **Off**, **Standard** or **Adaptive**.
- ▶ Press the  button to save the setting.
When Lane Keeping Assist or Active Lane Keeping Assist is activated, the multifunction display shows the lane markings as bright lines in the assistance graphic.

For further information about Lane Keeping Assist, see (▷ page 177).

For further information about Active Lane Keeping Assist, see (▷ page 181).

Service menu

Depending on the equipment installed in the vehicle, you have the following options in the **Serv.** menu:

- Calling up display messages in message memory (▷ page 197)
- Checking the tire pressure electronically (▷ page 287)
- Calling up the service due date (▷ page 258)

Settings menu

Introduction









Depending on the equipment installed in the vehicle, you have the following options in the **Sett.** menu:

- Changing the instrument cluster settings (▷ page 193)
- Changing the light settings (▷ page 194)
- Changing the vehicle settings (▷ page 195)
- Changing the convenience settings (▷ page 195)
- Restoring the factory settings (▷ page 196)

Instrument cluster

Selecting the distance unit

The **Display Unit Speed-/Odometer:** function allows you to choose whether certain displays appear in kilometers or miles in the multifunction display.

- ▶ Press the  or  button on the steering wheel to select the **Sett.** menu.
- ▶ Press the  or  button to select the **Instrument Cluster** submenu.
- ▶ Press  to confirm.
- ▶ Press the  or  button to select the **Display Unit Speed-/Odometer** function.
You will see the selected setting: **km** or **miles**.
- ▶ Press the  button to save the setting.

The selected unit of measurement for distance applies to:

- the digital speedometer in the **Trip** menu
- the odometer and trip odometer
- the trip computer
- the current consumption and the range
- the navigation instructions in the **Navi** menu
- cruise control
- DISTRONIC PLUS
- ASSYST PLUS service interval display

Selecting permanent display

The **Permanent Display:** function allows you to choose whether the multifunction display always shows the outside temperature or the speed.

The speed display is inverse to the speedometer.

- ▶ Press the or button on the steering wheel to select the **Sett.** menu.
- ▶ Press the or button to select the **Instrument Cluster** submenu.
- ▶ Press to confirm.
- ▶ Press the or button to select the **Permanent Display:** function.
The current setting, **Outside Temperature** or **Speedometer [km/h]/Speedometer [mph]**, appears.
- ▶ Press the button to save the setting.

Lights

Setting the brightness of the instrument cluster lighting and switches

The lighting in the instrument cluster, in the displays and the controls in the vehicle interior can be adjusted with the **Brightness Display/Switches:** function.

- ▶ Press the or button on the steering wheel to select the **Sett.** menu.
- ▶ Press the or button to select the **Lights** submenu.
- ▶ Press to confirm.
- ▶ Press the or button to select the **Brightness Display/Switches:** function.
The current setting appears.
- ▶ Press to confirm.
- ▶ Press the or button to adjust the brightness to any level from **Level 1** to **Level 5** (bright).
- ▶ Press the or button to save the setting.
If the light switch is set to the **AUTO**, or position, the brightness is dependent upon the brightness of the ambient light.

i The light sensor in the instrument cluster automatically controls the brightness of the multifunction display.

In daylight, the displays in the instrument cluster are not illuminated.

Switching the daytime running lamps on/off

- ▶ Press the or button on the steering wheel to select the **Sett.** menu.
- ▶ Press the or button to select the **Lights** submenu.
- ▶ Press to confirm.

- ▶ Press the or button to select the **Day. Run. Lights** function.
If the **Day. Run. Lights** function has been switched on, the multifunction display shows the cone of light and the symbol in orange.
- ▶ Press the button to save the setting.

Further information on daytime running lamps (▷ page 103).

Activating/deactivating surround lighting and exterior lighting delayed switch-off

- ▶ Press the or button on the steering wheel to select the **Sett.** menu.
- ▶ Press the or button to select the **Lights** submenu.
- ▶ Press to confirm.
- ▶ Using or , select the **Surround Lighting** function.
If the **Surround Lighting** function is activated, the light cone and the area around the vehicle are displayed in orange in the multifunction display.
- ▶ Press the button to save the setting.

Deactivating delayed switch-off of the exterior lighting temporarily:

- ▶ Before leaving the vehicle, turn the SmartKey to position **0** in the ignition lock.
- ▶ Turn the SmartKey to position **2** in the ignition lock.
The exterior lighting delayed switch-off is deactivated.

Delayed switch-off of the exterior lighting is reactivated the next time you start the engine. If you have activated the **Surround Lighting** function and the light switch is set to the **AUTO** position, the following functions are activated when it is dark:

- **surround lighting:** the exterior lighting remains lit for 40 seconds after unlocking with the SmartKey. If you start the engine, the surround lighting is switched off and automatic headlamp mode is activated (▷ page 103).
- **exterior lighting delayed switch-off:** the exterior lighting remains lit for 60 seconds after the engine is switched off. If you close all the doors and the trunk lid, the exterior lighting goes off after 15 seconds.

i Depending on your vehicle's equipment, when the surround lighting and delayed switch-off exterior lighting are on, the following light up:

- Parking lamps
- Side marker lamps
- Surround lighting in the exterior mirrors

Activating/deactivating the interior lighting delayed switch-off

If you activate the **Light. Delay** function, the interior lighting remains on for 20 seconds after you remove the SmartKey from the ignition lock.

- ▶ Press the or button on the steering wheel to select the **Sett.** menu.
- ▶ Press the or button to select the **Lights** submenu.
- ▶ Press to confirm.
- ▶ Press the or button to select the **Light. Delay** function.
When the **Light. Delay** function is activated, the vehicle interior is displayed in orange in the multifunction display.
- ▶ Press the button to save the setting.

Vehicle

Activating/deactivating the automatic door locking mechanism

- ▶ Press the or button on the steering wheel to select the **Sett.** menu.
- ▶ Press the or button to select the **Vehicle** submenu.
- ▶ Press to confirm.
- ▶ Press the or button to select the **Auto. Door Locks** function.
If the **Auto. Door Locks** function is switched on, the multifunction display shows the vehicle's doors in orange.
- ▶ Press the button to save the setting.

If you activate the **Auto. Door Locks** function, the vehicle is centrally locked above a speed of around 9 mph (15 km/h).

For further information on the automatic locking feature, see (> page 79).

Activating/deactivating the acoustic locking verification signal

If you switch on the **Acoustic Lock** function, an acoustic signal sounds when you lock the vehicle.

- ▶ Press the or button on the steering wheel to select the **Sett.** menu.
- ▶ Press the or button to select the **Vehicle** submenu.
- ▶ Press to confirm.
- ▶ Press the or button to select the **Acoustic Lock** function.
If the **Acoustic Lock** function is activated, the symbol in the multifunction display lights up orange.
- ▶ Press the button to save the setting.

Convenience

Activating/deactivating the EASY-ENTRY/EXIT feature

WARNING

When the EASY-ENTRY/EXIT feature adjusts the steering wheel, you and other vehicle occupants – particularly children – could become trapped. There is a risk of injury.



While the EASY-ENTRY/EXIT feature is making adjustments, make sure that no one has any body parts in the sweep of the steering wheel.

If somebody becomes trapped:

- press one of the memory function position buttons, or
- move the switch for steering wheel adjustment in the opposite direction to that in which the steering wheel is moving.

The adjustment process is stopped.

- ▶ Press the or button on the steering wheel to select the **Sett.** menu.
- ▶ Press the or button to select the **Convenience** submenu.
- ▶ Press to confirm.

- ▶ Using  or , select the **Easy Entry/Exit** function.

If the **Easy Entry/Exit** function is activated, the vehicle steering wheel is displayed in orange in the multifunction display.

- ▶ Press the  button to save the setting.

Further information on the EASY-ENTRY/EXIT feature (▶ page 98).

Switching the belt adjustment on/off

- ▶ Press the  or  button on the steering wheel to select the **Sett.** menu.

- ▶ Press the  or  button to select the **Convenience** submenu.

- ▶ Press  to confirm.

- ▶ Press the  or  button to select the **Belt Adjustment** function.

When the **Belt Adjustment** function is activated, the seat belt is displayed in orange in the multifunction display.

- ▶ Press the  button to save the setting.

For further information on belt adjustment, see (▶ page 45).

Switching the fold-in mirrors when locking feature on/off

This function is only available when the vehicle is equipped with the electrical fold-in function.

When you switch on the **Auto. Mirror Folding** function, the exterior mirrors are folded in when the vehicle is locked. If you unlock the vehicle and then open the driver's or front-passenger door, the exterior mirrors fold out again.

- ▶ Press the  or  button on the steering wheel to select the **Settings** menu.

- ▶ Press the  or  button to select the **Convenience** submenu.

- ▶ Press  to confirm.

- ▶ Press the  or  button to select the **Auto. Mirror Folding** function.

If the **Auto. Mirror Folding** function is switched on, the multifunction display shows the vehicle's exterior mirror in orange.

- ▶ Press the  button to save the setting.



If you have switched on the **Auto. Mirror Folding** function and you fold in the exterior mirrors by pressing button ①, the exterior mirrors will not fold out automatically (▶ page 100). You can then only fold out the exterior mirrors using button ①.

Restoring the factory settings

- ▶ Press the  or  button on the steering wheel to select the **Sett.** menu.

- ▶ Press the  or  button to select the **Factory Setting** submenu.

- ▶ Press  to confirm.

The **Reset All Settings?** function appears.

- ▶ Press the  or  button to select **No** or **Yes**.

- ▶ Press  to confirm the selection.

If you have selected **Yes** and confirmed, the multifunction display shows a confirmation message.

For safety reasons, the **Day Lights** function in the **Lights** submenu is only reset if the vehicle is stationary.

Display messages

Introduction

General notes

Display messages appear in the multifunction display.

Display messages with graphic displays may be shown in simplified form in the Operator's Manual and may differ from the messages shown in the multifunction display.

Please respond in accordance with the display messages and follow the additional notes in this Operator's Manual.

Certain display messages are accompanied by an audible warning tone or a continuous tone.

When the ignition is switched off, all display messages are deleted, apart from some high-priority display messages. Once the causes of the high-priority display messages have been rectified, the corresponding display messages are also deleted.

When you stop and park the vehicle, please observe the notes on:

- HOLD function (▷ page 156)
- Parking (▷ page 138)

Hiding display messages







- ▶ Press the  or  button on the steering wheel.
The multifunction display hides the display message.

The multifunction display shows high-priority display messages in red. Some high-priority display messages cannot be hidden.

The multifunction display shows these messages continuously until the causes for the messages have been remedied.

Message memory

The on-board computer saves certain display messages in the **message memory**. You can call up the display messages:

- ▶ Press the  or  button on the steering wheel to select the **Serv.** menu.
If there are display messages, the multifunction display shows **2 Messages**, for example.
- ▶ Press the  or  button to select the entry, e.g. **2 Messages**.
- ▶ Press  to confirm.
- ▶ Press the  or  button to scroll through the display messages.



Safety systems

Display messages



Currently Unavailable See Operator's Manual

Possible causes/consequences and ► Solutions

ABS (Anti-lock Braking System) and ESP® (Electronic Stability Program) are temporarily not available. Other driving systems and driving safety systems may also be faulty. In addition, the ,  and  warning lamps light up in the instrument cluster. For example, the on-board voltage may be insufficient.

 **WARNING**

The brake system continues to function normally, but without the functions listed above. The wheels could therefore lock if you brake hard, for example.

The steerability and braking characteristics may be severely affected. The braking distance in an emergency braking situation can increase.

If ESP® is not operational, ESP® is unable to stabilize the vehicle.

There is an increased risk of skidding and an accident.

► Drive on carefully.

If the display message disappears, the functions mentioned above are available again.

If the multifunction display still shows the display message:

► Drive on carefully.





► Visit a qualified specialist workshop immediately.



Inoperative See Operator's Manual

ABS and ESP® are malfunctioning.

Other driving systems and driving safety systems may also be faulty.

The  (USA only) or  (Canada only), ,  and  warning lamps in the instrument cluster also light up.

 **WARNING**

The brake system continues to function normally, but without the functions listed above. The wheels could therefore lock if you brake hard, for example.









The steerability and braking characteristics may be severely affected. The braking distance in an emergency braking situation can increase.





If ESP® is not operational, ESP® is unable to stabilize the vehicle.

There is an increased risk of skidding and an accident.



► Drive on carefully.







► Visit a qualified specialist workshop immediately.

| Display messages | Possible causes/consequences and ► Solutions |
|--|--|
|  <p>Inoperative See Operator's Manual</p> | <p>ESP® is malfunctioning. Other driving systems and driving safety systems may also be faulty. In addition, the  and  warning lamps light up in the instrument cluster. The self-diagnosis function might not be complete, for example.</p> <p>⚠ WARNING</p> <p>The brake system continues to function normally, but without the functions listed above. The braking distance in an emergency braking situation can thus increase. If ESP® is not operational, ESP® is unable to stabilize the vehicle. There is an increased risk of skidding and an accident.</p> <ul style="list-style-type: none"> ► Drive on carefully. ► Visit a qualified specialist workshop immediately. |
|   <p>Inoperative See Operator's Manual</p> | <p>EBD (electronic brake force distribution), ABS and ESP® are malfunctioning. Other driving systems and driving safety systems may also be faulty. In addition, the ,  and  warning lamps light up in the instrument cluster and a warning tone sounds.</p> <p>⚠ WARNING</p> <p>The brake system continues to function normally, but without the functions listed above. The front and rear wheels could therefore lock if you brake hard, for example. The steerability and braking characteristics may be severely affected. The braking distance in an emergency braking situation can increase. If ESP® is not operational, ESP® is unable to stabilize the vehicle. There is an increased risk of skidding and an accident.</p> <ul style="list-style-type: none"> ► Drive on carefully. ► Visit a qualified specialist workshop immediately. |
| <p>PARK (USA only)  (Canada only)</p> <p>Please Release Parking Brake</p> | <p>You are driving with the parking brake applied. A warning tone also sounds.</p> <ul style="list-style-type: none"> ► Release the parking brake. |

| Display messages | Possible causes/consequences and ► Solutions |
|---|---|
|  <p>only)  (Canada only) Check Brake Fluid Level</p> | <p>There is not enough brake fluid in the brake fluid reservoir. In addition, the  WARNING</p> <p>The braking effect may be impaired. There is a risk of an accident.</p> <ul style="list-style-type: none"> ► Pull over and stop the vehicle safely as soon as possible, paying attention to road and traffic conditions. Do not continue driving under any circumstances. ► Secure the vehicle against rolling away (▷ page 138). ► Consult a qualified specialist workshop. ► Do not add brake fluid. This does not correct the malfunction. |
|  <p>Check Brake Pad Wear</p> | <p>The brake pads/linings have reached their wear limit.</p> <ul style="list-style-type: none"> ► Visit a qualified specialist workshop. |
|  <p>brace Inoperative</p> | <p>One or more main features of the mbrace system are malfunctioning.</p> <ul style="list-style-type: none"> ► Visit a qualified specialist workshop. |
| <p>Collision Prevention Assist Plus Currently Unavailable See Operator's Manual</p> | <p>COLLISION PREVENTION ASSIST PLUS is temporarily not operational. Possible causes are:</p> <ul style="list-style-type: none"> • the radar sensor system is temporarily inoperative, e.g. due to electromagnetic radiation emitted by nearby TV or radio stations or other sources of electromagnetic radiation. • the system is outside the operating temperature range. • the on-board voltage is too low. <p>When the causes stated above no longer apply, the display message disappears.</p> <p>COLLISION PREVENTION ASSIST PLUS is operational again.</p> <p>If the display message does not disappear:</p> <ul style="list-style-type: none"> ► Pull over and stop the vehicle safely as soon as possible, paying attention to road and traffic conditions. ► Secure the vehicle against rolling away (▷ page 138). ► Restart the engine. |
| <p>Collision Prevention Assist Plus Inoperative</p> | <p>COLLISION PREVENTION ASSIST PLUS is temporarily inoperative due to a malfunction. Adaptive Brake Assist may also have failed.</p> <ul style="list-style-type: none"> ► Visit a qualified specialist workshop. |
| <p>PRE-SAFE Inoperative See Operator's Manual</p> | <p>Important functions of PRE-SAFE® have failed. All other occupant safety systems, e.g. air bags, remain available.</p> <ul style="list-style-type: none"> ► Visit a qualified specialist workshop. |





| Display messages | Possible causes/consequences and ► Solutions |
|---|--|
| <p>PRE-SAFE Functions Currently Limited See Operator's Manual</p> | <p>PRE-SAFE® PLUS or PRE-SAFE® Brake is temporarily inoperative. Possible causes are:</p> <ul style="list-style-type: none"> • function is impaired due to heavy rain or snow. • the radar sensor system is temporarily inoperative, e.g. due to electromagnetic radiation emitted by nearby TV or radio stations or other sources of electromagnetic radiation. • the system is outside the operating temperature range. • the on-board voltage is too low. <p>When the causes stated above no longer apply, the display message disappears.</p> <p>PRE-SAFE® PLUS and PRE-SAFE® Brake are operational again.</p> <p>If the display message does not disappear:</p> <ul style="list-style-type: none"> ► Pull over and stop the vehicle safely as soon as possible, paying attention to road and traffic conditions. ► Secure the vehicle against rolling away (▷ page 138). ► Restart the engine. |
| <p>PRE-SAFE Functions Limited See Operator's Manual</p> | <p>PRE-SAFE® PLUS or PRE-SAFE® Brake is unavailable due to a malfunction. BAS PLUS with Cross-Traffic Assist may also have failed.</p> <ul style="list-style-type: none"> ► Visit a qualified specialist workshop. |



| Display messages | Possible causes/consequences and ► Solutions |
|--|---|
| <p>Radar Sensors Dirty See Operator's Manual</p> | <p>At least one of the following driving systems or driving safety systems is temporarily restricted or inoperative:</p> <ul style="list-style-type: none"> • COLLISION PREVENTION ASSIST PLUS • PRE-SAFE® Brake • PRE-SAFE® PLUS • Active Lane Keeping Assist • Active Blind Spot Assist • DISTRONIC PLUS with Steering Assist and Stop&Go Pilot <p>If the radar sensor system in front is dirty, Active Blind Spot Assist will not perform a course-correcting brake application.</p> <p>Possible causes are:</p> <ul style="list-style-type: none"> • the sensors in the radiator trim and/or in the bumpers are dirty • the function of the driving system or driving safety system is impaired due to heavy rain or snow <p>A warning tone also sounds.</p> <p>When the causes stated above no longer apply, the display message disappears. All driving systems or driving safety systems are operative again.</p> <p>If the display message does not disappear:</p> <ul style="list-style-type: none"> ► Pull over and stop the vehicle safely as soon as possible, paying attention to road and traffic conditions. ► Secure the vehicle against rolling away (▷ page 138). ► Switch off the engine. ► Clean the sensors in the following locations (▷ page 262): <ul style="list-style-type: none"> • in the radiator trim • in the front bumper • in the rear bumper, particularly in the middle of the rear bumper ► Restart the engine. <p>The display message disappears.</p> |
| <p> SRS Malfunction Service Required</p> | <p>The restraint system is faulty. The  warning lamp also lights up in the instrument cluster.</p> <p> WARNING</p> <p>The air bags or Emergency Tensioning Devices may either be triggered unintentionally or, in the event of an accident, may not be triggered. There is an increased risk of injury.</p> <ul style="list-style-type: none"> ► Visit a qualified specialist workshop immediately. <p>Observe the additional information on restraint systems (▷ page 40).</p> |





| Display messages | Possible causes/consequences and ► Solutions |
|--|--|
|  <p>Front Left Malfunction Service Required or Front Right Malfunction Service Required</p> | <p>The restraint system has malfunctioned at the front on the left or right. The  warning lamp also lights up in the instrument cluster.</p> <p>⚠ WARNING</p> <p>The air bags or Emergency Tensioning Devices may either be triggered unintentionally or, in the event of an accident, may not be triggered. There is an increased risk of injury.</p> <p>► Visit a qualified specialist workshop immediately.</p> |
|  <p>Rear Left Malfunction Service Required or Rear Right Malfunction Service Required</p> | <p>The restraint system has malfunctioned at the rear on the left or right. The  warning lamp also lights up in the instrument cluster.</p> <p>⚠ WARNING</p> <p>The air bags or Emergency Tensioning Devices may either be triggered unintentionally or, in the event of an accident, may not be triggered. There is an increased risk of injury.</p> <p>► Visit a qualified specialist workshop immediately.</p> |
|  <p>Left Side Curtain Airbag Malfunction Service Required or Right Side Curtain Airbag Malfunction Service Required</p> | <p>There is a malfunction in the left-hand or right-hand window curtain air bag (Coupe) or head bag (Cabriolet). The  warning lamp also lights up in the instrument cluster.</p> <p>⚠ WARNING</p> <p>The left or right window curtain air bag (Coupe) or head bag (Cabriolet) may either be triggered unintentionally or, in the event of an accident, may not be triggered. There is an increased risk of injury.</p> <p>► Visit a qualified specialist workshop immediately.</p> |



| Display messages | Possible causes/consequences and ► Solutions |
|---|--|
| <p>Front Passenger Air-bag Disabled See Operator's Manual</p> | <p>The front-passenger air bag is deactivated during the journey, even though:</p> <ul style="list-style-type: none"> • an adult or • a person of the corresponding stature is on the front-passenger seat <p>If additional forces are applied to the seat, the system may interpret the occupant's weight as lower than it actually is.</p> <p> WARNING</p> <p>The front-passenger air bag does not deploy during an accident. There is an increased risk of injury.</p> <ul style="list-style-type: none"> ► Pull over and stop the vehicle safely as soon as possible, paying attention to road and traffic conditions. ► Secure the vehicle against rolling away (▷ page 138). ► Switch the ignition off. ► Have the occupant get out of the vehicle. ► Keep the seat unoccupied, close the front-passenger door and switch on the ignition. ► Observe the PASSENGER AIR BAG OFF indicator lamp in the center console and the multifunction display and check the following: Seat unoccupied and ignition switched on: <ul style="list-style-type: none"> • a self-diagnosis is carried out. The PASSENGER AIR BAG OFF and PASSENGER AIR BAG ON indicator lamps must light up simultaneously for approximately six seconds • the PASSENGER AIR BAG OFF indicator lamp must then light up and remain lit after the self-diagnosis. If the indicator lamp is on, OCS (Occupant Classification System) has disabled the front-passenger front air bag (▷ page 49) • the Front Passenger Airbag Enabled See Operator's Manual or Front Passenger Airbag Disabled See Operator's Manual display messages must not be shown in the multifunction display ► Wait for a period of at least 60 seconds until the necessary system checks have been completed. ► Make sure that the display messages do not appear in the multifunction display. <p>If these conditions are fulfilled, the front-passenger seat can be occupied again. Whether the PASSENGER AIR BAG OFF indicator lamp remains lit or goes out depends on how OCS classifies the occupant. If the conditions are not fulfilled, the system is not operating correctly.</p> <ul style="list-style-type: none"> ► Visit a qualified specialist workshop immediately. <p>Observe the additional information on OCS (▷ page 49).</p> |
| <p>Front Passenger Air-bag Enabled See Operator's Manual</p> | <p>The front-passenger air bag is enabled during the journey, even though:</p> <ul style="list-style-type: none"> • a child, a small adult or an object weighing less than the system's weight threshold is located on the front-passenger seat |



| Display messages | Possible causes/consequences and ► Solutions |
|------------------|---|
| | <p>or</p> <ul style="list-style-type: none"> • the front-passenger seat is unoccupied <p>The system may detect objects or forces applying additional weight on the seat.</p> <p> WARNING</p> <p>The air bag may deploy unintentionally. There is an increased risk of injury.</p> <ul style="list-style-type: none"> ► Pull over and stop the vehicle safely as soon as possible, paying attention to road and traffic conditions. ► Secure the vehicle against rolling away (▷ page 138). ► Switch the ignition off. ► Open the front-passenger door. ► Remove the child and the child restraint system from the front-passenger seat. ► Make sure that there are no objects on the seat adding to the weight. The system may otherwise detect the additional weight and interpret the seat occupant's weight as greater than it actually is. ► Keep the seat unoccupied, close the front-passenger door and switch on the ignition. ► Observe the PASSENGER AIR BAG OFF indicator lamp in the center console and the multifunction display and check the following: Seat unoccupied and ignition switched on: <ul style="list-style-type: none"> • a self-diagnosis is carried out. The PASSENGER AIR BAG OFF and PASSENGER AIR BAG ON indicator lamps must light up simultaneously for approximately six seconds • the PASSENGER AIR BAG OFF indicator lamp must then light up and remain lit after the self-diagnosis. If the indicator lamp is on, OCS has disabled the front-passenger front air bag (▷ page 49) • the Front Passenger Airbag Enabled See Operator's Manual or Front Passenger Airbag Disabled See Operator's Manual display messages must not be shown in the multifunction display ► Wait for a period of at least 60 seconds until the necessary system checks have been completed. ► Make sure that the display messages do not appear in the multifunction display. <p>If these conditions are fulfilled, the front-passenger seat can be occupied again. Whether the PASSENGER AIR BAG OFF indicator lamp remains lit or goes out depends on how OCS classifies the occupant. If the conditions are not fulfilled, the system is not operating correctly.</p> <ul style="list-style-type: none"> ► Visit a qualified specialist workshop immediately. <p>Observe the additional information on OCS (▷ page 49).</p> |

| Lights | |
|--|--|
| Display messages | Possible causes/consequences and ► Solutions |
|  Check Left Low Beam (example) | The corresponding bulb is faulty. ► Visit a qualified specialist workshop. or ► Check whether you are permitted to replace the bulb yourself (► page 107). ⓘ LED light sources: the display message for the corresponding lamp only appears when all the LEDs in the lamp have failed. |
|  Active Headlamps Inoperative | The active light function is faulty. ► Visit a qualified specialist workshop. |
|  Malfunction See Operator's Manual | The exterior lighting is defective. ► Visit a qualified specialist workshop. |
|  Auto Lamp Function Inoperative | The light sensor is defective. ► Visit a qualified specialist workshop. |
|  Switch Off Lights | You leave the vehicle and the lights are switched on. A warning tone also sounds. ► Turn the light switch to position AUTO . |
| Adaptive Highbeam Assist Currently Unavailable See Operator's Manual | Adaptive Highbeam Assist is deactivated and temporarily inoperative. Possible causes are: <ul style="list-style-type: none"> • the windshield in the camera's field of vision is dirty. • visibility is impaired due to heavy rain, snow or fog. ► Clean the windshield. If the system detects that the camera is fully operational again, the Adaptive Highbeam Assist Now Available message is displayed. Adaptive Highbeam Assist is operational again. |
| Adaptive Highbeam Assist Inoperative | Adaptive Highbeam Assist is faulty. ► Visit a qualified specialist workshop. |

| Engine | |
|---|---|
| Display messages | Possible causes/consequences and ► Solutions |
|  <p>Check Coolant Level See Operator's Manual</p> | <p>The coolant level is too low.</p> <p>! Avoid making long journeys with too little coolant in the engine cooling system. The engine will otherwise be damaged.</p> <ul style="list-style-type: none"> ► Add coolant, observing the warning notes before doing so (▷ page 256). ► If you need to add coolant more often than usual, have the engine coolant system checked at a qualified specialist workshop. |
|  | <p>The fan motor is faulty.</p> <ul style="list-style-type: none"> ► At coolant temperatures below 248 °F (120 °C), drive to the nearest qualified specialist workshop. ► Avoid subjecting the engine to heavy loads, e.g. driving in mountainous terrain, and stop-and-go traffic. |
|  <p>Coolant Too Hot Stop Vehicle Turn Engine Off</p> | <p>The coolant is too hot. A warning tone also sounds.</p> <p>▲ WARNING</p> <p>Do not drive when your engine is overheated. This can cause some fluids which may have leaked into the engine compartment to catch fire.</p> <p>Steam from the overheated engine can also cause serious burns which can occur just by opening the hood.</p> <p>There is a risk of injury.</p> <ul style="list-style-type: none"> ► Pull over and stop the vehicle safely and switch off the engine, paying attention to road and traffic conditions. ► Secure the vehicle against rolling away (▷ page 138). ► Wait until the engine has cooled down. ► Make sure that the air supply to the engine radiator is not blocked, e.g. by snow, slush or ice. ► Do not start the engine again until the display message goes out and the coolant temperature is below 248 °F (120 °C). Otherwise, the engine could be damaged. ► Pay attention to the coolant temperature display. ► If the temperature increases again, visit a qualified specialist workshop immediately. <p>Under normal operating conditions and with the specified coolant level, the coolant temperature may rise to 248 °F (120 °C).</p> |

| Display messages | Possible causes/consequences and ► Solutions |
|---|---|
|  <p data-bbox="87 220 316 268">See Operator's Manual</p> | <p data-bbox="344 172 661 196">The battery is not being charged.</p> <p data-bbox="344 204 613 228">A warning tone also sounds.</p> <p data-bbox="344 236 538 260">Possible causes are:</p> <ul data-bbox="350 268 669 355" style="list-style-type: none"> <li data-bbox="350 268 572 292">• a defective alternator <li data-bbox="350 300 533 323">• a torn poly-V-belt <li data-bbox="350 331 669 355">• a malfunction in the electronics <p data-bbox="344 371 977 395">! Do not continue driving. The engine could otherwise overheat.</p> <ul data-bbox="344 403 1003 515" style="list-style-type: none"> <li data-bbox="344 403 1003 459">► Pull over and stop the vehicle safely and switch off the engine, paying attention to road and traffic conditions. <li data-bbox="344 467 876 491">► Secure the vehicle against rolling away (▷ page 138). <li data-bbox="344 499 748 515">► Consult a qualified specialist workshop. |
|  <p data-bbox="87 595 288 643">Stop Vehicle See Operator's Manual</p> | <p data-bbox="344 547 1003 595">The battery is no longer being charged and the battery charge level is too low.</p> <p data-bbox="344 603 613 627">A warning tone also sounds.</p> <ul data-bbox="344 643 1003 802" style="list-style-type: none"> <li data-bbox="344 643 1003 691">► Pull over and stop the vehicle safely and switch off the engine, paying attention to road and traffic conditions. <li data-bbox="344 699 876 722">► Secure the vehicle against rolling away (▷ page 138). <li data-bbox="344 730 977 778">► Observe the instructions in the  See Operator's Manual display message. <li data-bbox="344 786 748 802">► Consult a qualified specialist workshop. |
|  <p data-bbox="87 874 311 922">Check Engine Oil At Next Refueling</p> | <p data-bbox="344 826 865 850">The engine oil level has dropped to the minimum level.</p> <p data-bbox="344 858 613 882">A warning tone also sounds.</p> <p data-bbox="344 898 1003 946">! Avoid long journeys with too little engine oil. The engine will otherwise be damaged.</p> <ul data-bbox="344 962 1003 1074" style="list-style-type: none"> <li data-bbox="344 962 1003 986">► Check the oil level when next refueling, at the latest (▷ page 255). <li data-bbox="344 994 764 1018">► If necessary, add engine oil (▷ page 256). <li data-bbox="344 1026 1003 1074">► Have the engine checked at a qualified specialist workshop if you need to add engine oil more often than usual. <p data-bbox="344 1090 1003 1161">Information on approved engine oils can be obtained from any qualified specialist workshop or on the Internet at http://bevo.mercedes-benz.com.</p> |
|  <p data-bbox="87 1233 255 1257">Fuel Level Low</p> | <p data-bbox="344 1185 820 1209">The fuel level has dropped into the reserve range.</p> <ul data-bbox="344 1217 686 1241" style="list-style-type: none"> <li data-bbox="344 1217 686 1241">► Refuel at the nearest gas station. |

| Display messages | Possible causes/consequences and ► Solutions |
|--|---|
|  | There is only a very small amount of fuel in the fuel tank. ► Refuel at the nearest gas station without fail. |
|  Gas Cap Loose | The fuel filler cap is not closed correctly or the fuel system is leaking. ► Check that the fuel filler cap is correctly closed. If the fuel filler cap is not correctly closed: ► Close the fuel filler cap. If the fuel filler cap is correctly closed: ► Visit a qualified specialist workshop. |



| Driving systems | |
|---|--|
| Display messages | Possible causes/consequences and ► Solutions |
|  Attention Assist: Take a Break! | Based on certain criteria, ATTENTION ASSIST has detected fatigue or a lack of concentration on the part of the driver. A warning tone also sounds. ► If necessary, take a break. During long journeys, take regular breaks in good time so you get enough rest. |
|  Attention Assist Inoperative | ATTENTION ASSIST is inoperative. ► Visit a qualified specialist workshop. |
| Traffic Sign Assist Currently Unavailable See Operator's Manual | Traffic Sign Assist is temporarily inoperative. Possible causes are: <ul style="list-style-type: none"> • the windshield in the camera's field of vision is dirty. • visibility is impaired due to heavy rain, snow or fog. ► Clean the windshield. If the system detects that the camera is fully operational, the display message disappears. Traffic Sign Assist is operational again. |
| Traffic Sign Assist Inoperative | Traffic Sign Assist is faulty. ► Visit a qualified specialist workshop. |
|  HOLD Off | The HOLD function is deactivated. The vehicle is skidding. A warning tone also sounds. ► Reactivate the HOLD function later (► page 156). |

| Display messages | Possible causes/consequences and ► Solutions |
|--|---|
| | <p>The HOLD function is deactivated. When the brake pedal is firmly depressed, an activation condition is not fulfilled. A warning tone also sounds.</p> <p>► Check the activation conditions for the HOLD function (▷ page 156).</p> |
| <p>Lane Keeping Assist Currently Unavailable See Operator's Manual or Active Lane Keeping Assist Currently Unavailable See Operator's Manual</p> | <p>Lane Keeping Assist or Active Lane Keeping Assist is deactivated and temporarily inoperative.</p> <p>Possible causes are:</p> <ul style="list-style-type: none"> • the windshield in the camera's field of vision is dirty. • visibility is impaired due to heavy rain, snow or fog. • there have been no lane markings for an extended period. • the lane markings are worn, dark or covered, e.g. by dirt or snow. <p>When the causes stated above no longer apply, the display message disappears.</p> <p>Lane Keeping Assist or Active Lane Keeping Assist is operational again.</p> <p>If the display message does not disappear:</p> <p>► Pull over and stop the vehicle safely as soon as possible, paying attention to road and traffic conditions.</p> <p>► Secure the vehicle against rolling away (▷ page 138).</p> <p>► Clean the windshield.</p> |
| <p>Lane Keeping Assist Inoperative or Active Lane Keeping Assist Inoperative</p> | <p>Lane Keeping Assist or Active Lane Keeping Assist is defective.</p> <p>► Visit a qualified specialist workshop.</p> |
| <p>Blind Spot Assist Currently Unavailable See Operator's Manual or Active Blind Spot Assist Currently Unavailable See Operator's Manual</p> | <p>Blind Spot Assist or Active Blind Spot Assist is temporarily inoperative.</p> <p>Possible causes are:</p> <ul style="list-style-type: none"> • the radar sensor system is outside the operating temperature range. • the radar sensor system is temporarily inoperative, e.g. due to electromagnetic radiation emitted by nearby TV or radio stations or other sources of electromagnetic radiation. <p>The yellow  indicator lamps also light up in the exterior mirrors.</p> <p>When the causes stated above no longer apply, the display message disappears.</p> <p>Blind Spot Assist or Active Blind Spot Assist is operational again.</p> <p>If the display message does not disappear:</p> <p>► Pull over and stop the vehicle safely as soon as possible, paying attention to road and traffic conditions.</p> <p>► Secure the vehicle against rolling away (▷ page 138).</p> <p>► Restart the engine.</p> |

| Display messages | Possible causes/consequences and ► Solutions |
|---|---|
| Blind Spot Assist Inoperative or Active Blind Spot Assist Inoperative | Blind Spot Assist or Active Blind Spot Assist is defective. The yellow  indicator lamps also light up in the exterior mirrors. ► Visit a qualified specialist workshop. |
| Park Assist Canceled | The driver's door is open and the driver's seat belt has not been fastened. ► Repeat the parking process with the seat belt fastened and the driver's door closed. |
| | You have inadvertently touched the multifunction steering wheel while steering intervention was active. ► While steering intervention is active, make sure that the multifunction steering wheel is not touched unintentionally. |
| | The vehicle has started to skid and ESP® has intervened. ► Use Active Parking Assist again later (► page 161). |
| Park Assist Inoperative | You have just carried out a large number of turning or parking maneuvers. Active Parking Assist will become available again after approximately ten minutes (► page 161). ► Pull over and stop the vehicle safely as soon as possible, paying attention to road and traffic conditions. ► Switch off and restart the engine. |
| | If the multifunction display still shows the display message: ► Visit a qualified specialist workshop. |
| | PARKTRONIC is defective. ► Visit a qualified specialist workshop. |
| Park Assist Finished | The vehicle is parked. A warning tone also sounds. The display message disappears automatically. |
| DISTRONIC PLUS Off | DISTRONIC PLUS has been deactivated. If a warning tone also sounds, DISTRONIC PLUS has deactivated automatically (► page 147) |
| DISTRONIC PLUS Now Available | DISTRONIC PLUS is operational again after having been temporarily unavailable. You can now reactivate DISTRONIC PLUS (► page 147). |

| Display messages | Possible causes/consequences and ► Solutions |
|--|---|
| <p>DISTRONIC PLUS Currently Unavailable See Operator's Manual</p> | <p>DISTRONIC PLUS is temporarily inoperative. Steering Assist and Stop&Go Pilot are temporarily inoperative. Possible causes are:</p> <ul style="list-style-type: none"> • the radar sensor system is temporarily inoperative, e.g. due to electromagnetic radiation emitted by nearby TV or radio stations or other sources of electromagnetic radiation. • the system is outside the operating temperature range. • the on-board voltage is too low. <p>A warning tone also sounds.</p> <p>When the causes stated above no longer apply, the display message disappears.</p> <p>DISTRONIC PLUS is operational again.</p> <p>If the display message does not disappear:</p> <ul style="list-style-type: none"> ► Pull over and stop the vehicle safely as soon as possible, paying attention to road and traffic conditions. ► Secure the vehicle against rolling away (▷ page 138). ► Restart the engine. |
| <p>DISTRONIC PLUS Inoperative</p> | <p>DISTRONIC PLUS is defective. The following may have also failed:</p> <ul style="list-style-type: none"> • BAS PLUS with Cross-Traffic Assist • PRE-SAFE® Brake • Steering Assist and Stop&Go Pilot <p>A warning tone also sounds.</p> <ul style="list-style-type: none"> ► Visit a qualified specialist workshop. |
| <p>DISTRONIC PLUS Suspended</p> | <p>You have depressed the accelerator pedal. DISTRONIC PLUS is no longer controlling the speed of the vehicle.</p> <ul style="list-style-type: none"> ► Remove your foot from the accelerator pedal. |
| <p>DISTRONIC PLUS - - - mph</p> | <p>An activation condition for DISTRONIC PLUS is not fulfilled.</p> <ul style="list-style-type: none"> ► Check the activation conditions for DISTRONIC PLUS (▷ page 147). |

| Display messages | Possible causes/consequences and ► Solutions |
|---|--|
| <p>DTR+: Steering Assist. Currently Unavailable See Operator's Manual</p> | <p>Steering Assist and Stop&Go Pilot are temporarily inoperative. Possible causes are:</p> <ul style="list-style-type: none"> • the windshield in the camera's field of vision is dirty. • visibility is impaired due to heavy rain, snow or fog. • there have been no lane markings for an extended period. • the lane markings are worn, dark or covered, e.g. by dirt or snow. <p>When the causes stated above no longer apply, the display message disappears.</p> <p>Steering Assist and Stop&Go Pilot are operative again.</p> <p>If the display message does not disappear:</p> <ul style="list-style-type: none"> ► Pull over and stop the vehicle safely as soon as possible, paying attention to road and traffic conditions. ► Secure the vehicle against rolling away (▷ page 138). ► Clean the windshield. |
| <p>DTR+: Steering Assist. Inoperative</p> | <p>Steering Assist and Stop&Go Pilot are faulty. However, the DISTRONIC PLUS functions are still available. A warning tone also sounds.</p> <ul style="list-style-type: none"> ► Visit a qualified specialist workshop. |
| <p>Cruise Control Inoperative</p> | <p>Cruise control is malfunctioning. A warning tone also sounds.</p> <ul style="list-style-type: none"> ► Visit a qualified specialist workshop. |
| <p>Cruise Control - - - mph</p> | <p>A condition for activating cruise control has not been fulfilled. You have tried to store a speed below 20 mph (30 km/h), for example.</p> <ul style="list-style-type: none"> ► If conditions permit, drive faster than 20 mph (30 km/h) and store the speed. ► Check the activation conditions for cruise control (▷ page 145). |
| <p>Cruise Control Off</p> | <p>Cruise control has been deactivated.</p> <p>If a warning tone also sounds, cruise control has deactivated automatically (▷ page 145).</p> |





| Tires | |
|-----------------------------|---|
| Display messages | Possible causes/consequences and ► Solutions |
| Correct Tire Pressure | <p>The tire pressure is too low in at least one of the tires, or the tire pressure difference between the wheels is too great.</p> <ul style="list-style-type: none"> ► Check the tire pressures at the next opportunity (▷ page 287). ► If necessary, correct the tire pressure. ► Restart the tire pressure monitor (▷ page 289). |
| Check Tires | <p>The tire pressure in one or more tires has dropped significantly. The wheel position is shown in the multifunction display. A warning tone also sounds.</p> <p> WARNING</p> <p>Tire pressures that are too low pose the following hazards:</p> <ul style="list-style-type: none"> • they may burst, especially as the load and vehicle speed increase. • they may wear excessively and/or unevenly, which may greatly impair tire traction. • the driving characteristics, as well as steering and braking, may be greatly impaired. <p>There is a risk of an accident.</p> <ul style="list-style-type: none"> ► Stop the vehicle without making any sudden steering or braking maneuvers. Pay attention to the traffic conditions as you do so. ► Secure the vehicle against rolling away (▷ page 138). ► Check the tires and, if necessary, follow the instructions for a flat tire (▷ page 266). ► Check the tire pressure (▷ page 287). ► If necessary, correct the tire pressure. |
| Warning Tire Malfunction | <p>The tire pressure in one or more tires has dropped suddenly. The wheel position is shown in the multifunction display.</p> <p> WARNING</p> <p>Driving with a flat tire poses a risk of the following hazards:</p> <ul style="list-style-type: none"> • a flat tire affects the ability to steer or brake the vehicle. • you could lose control of the vehicle. • continued driving with a flat tire will cause excessive heat build-up and possibly a fire. <p>There is a risk of an accident.</p> <ul style="list-style-type: none"> ► Stop the vehicle without making any sudden steering or braking maneuvers. Pay attention to the traffic conditions as you do so. ► Secure the vehicle against rolling away (▷ page 138). ► Check the tires and, if necessary, follow the instructions for a flat tire (▷ page 266). |



| Display messages | Possible causes/consequences and ► Solutions |
|--|--|
| Tire Press. Monitor Currently Unavailable | <p>Because there is interference from a strong source of radio waves, no signals from the tire pressure sensors are detected. The tire pressure monitor is temporarily malfunctioning.</p> <p>► Drive on. The tire pressure monitor restarts automatically as soon as the problem has been resolved.</p> |
| TirePress. Sensor(s) Missing | <p>There is no signal from the tire pressure sensor of one or several wheels. The pressure of the affected tire does not appear in the multifunction display.</p> <p>► Have the faulty tire pressure sensor replaced at a qualified specialist workshop.</p> |
| Tire Pressure Monitor Inoperative No Wheel Sensors | <p>The wheels mounted do not have a suitable tire pressure sensor. The tire pressure monitor is deactivated.</p> <p>► Mount wheels with suitable tire pressure sensors. The tire pressure monitor is activated automatically after driving for a few minutes.</p> |
| Tire Press. Monitor Inoperative | <p>The tire pressure monitor is faulty.</p> <p>► Visit a qualified specialist workshop.</p> |

Vehicle





| Display messages | Possible causes/consequences and ► Solutions |
|--|--|
| Shift to 'P' or 'N' to Start Engine: | <p>You have attempted to start the engine with the transmission in position R or D.</p> <p>► Shift the transmission to position P or N.</p> |
| To Shift from 'P' Apply Brake | <p>You have attempted to move the transmission selector lever to position D, R or N without depressing the brake pedal.</p> <p>► Depress the brake pedal.</p> |
| To Deselect P or N, Depress Brake and Start Engine | <p>With the engine switched off, you have attempted to shift the transmission out of position P or N into another transmission position.</p> <p>► Depress the brake pedal. ► Start the engine.</p> |



| Display messages | Possible causes/consequences and ► Solutions |
|--|---|
| Risk of Rolling Away Vehicle Not in 'P' | <p>The driver's door is open or not fully closed and the transmission is in position R, N or D. A warning tone also sounds.</p> <p> WARNING</p> <p>The vehicle may roll away. There is a risk of an accident.</p> <ul style="list-style-type: none"> ► Shift the transmission to position P. ► Secure the vehicle against rolling away (▷ page 138). ► Close the driver's door completely. |
| Only Shift to 'P' when Vehicle is Stationary | <p>The vehicle is moving.</p> <ul style="list-style-type: none"> ► Pull over and stop the vehicle safely as soon as possible, paying attention to road and traffic conditions. ► Shift the transmission to position P. |
| Service Required Do Not Shift Gears Visit Dealer | <p>You cannot change the transmission position due to a malfunction. A warning tone also sounds.</p> <p>If transmission position D is selected:</p> <ul style="list-style-type: none"> ► Drive to a qualified specialist workshop without shifting the transmission from position D. <p>If transmission position R, N or P is selected:</p> <ul style="list-style-type: none"> ► Secure the vehicle against rolling away (▷ page 138). ► Notify a qualified specialist workshop or breakdown service. |
| Reversing Not Poss. Service Required | <p>You cannot shift into the transmission position R due to a malfunction. The transmission positions P, N or D continue to be available. A warning tone also sounds.</p> <ul style="list-style-type: none"> ► Visit a qualified specialist workshop. |
| Transmission Mal- function Stop | <p>A malfunction has occurred in the mechanical transmission components. A warning tone also sounds. The gearbox automatically shifts to position N.</p> <ul style="list-style-type: none"> ► Pull over and stop the vehicle safely as soon as possible, paying attention to road and traffic conditions. ► Shift the transmission to position P. ► Secure the vehicle against rolling away (▷ page 138). ► Notify a qualified specialist workshop or breakdown service. |
| Auxiliary Battery Malfunction | <p>The auxiliary battery for the transmission is no longer being charged.</p> <ul style="list-style-type: none"> ► Visit a qualified specialist workshop at the next opportunity. ► Until then, set the transmission to position P before you switch off the engine. ► Before leaving the vehicle, apply the parking brake. |

| Display messages | Possible causes/consequences and ► Solutions |
|--|---|
|  | <p>The trunk lid is open.</p> <p>► Close the trunk lid.</p> |
|  | <p>The hood is open. A warning tone also sounds.</p> <p>⚠ WARNING</p> <p>The open hood may block your view when the vehicle is in motion. There is a risk of an accident.</p> <p>► Pull over and stop the vehicle safely as soon as possible, paying attention to road and traffic conditions.</p> <p>► Secure the vehicle against rolling away (▷ page 138).</p> <p>► Close the hood.</p> |
|  | <p>At least one door is open. A warning tone also sounds.</p> <p>► Close all the doors.</p> |
|  <p>Rear Left Backrest Not Latched or Rear Right Backrest Not Latched</p> | <p>The backrest in the rear is not engaged on the left-hand and/or right-hand side. A warning tone also sounds.</p> <p>► Push the backrest back until it engages.</p> |
|  <p>Lock Seat Backrest Front Left or Lock Seat Backrest Front Right</p> | <p>The driver's or front passenger's seat backrest is not engaged. A warning tone also sounds.</p> <p>► Push the backrest back until it engages.</p> |
| <p>Phone No Service</p> | <p>Your vehicle is outside the network provider's transmitter/receiver range.</p> <p>► Wait until the mobile phone operational readiness symbol appears in the multifunction display.</p> |

| Display messages | Possible causes/consequences and ► Solutions |
|--|--|
|  <p>Power Steering Malfunction See Operator's Manual</p> | <p>The power steering is malfunctioning. A warning tone also sounds.</p> <p> WARNING</p> <p>You will need to use more force to steer. There is a risk of an accident.</p> <ul style="list-style-type: none"> ► Check whether you are able to apply the extra force required. ► If you are able to steer safely: carefully drive on to a qualified specialist workshop. ► If you are unable to steer safely: do not drive on. Contact the nearest qualified specialist workshop. |
|  <p>Check Washer Fluid</p> | <p>The washer fluid level in the washer fluid reservoir has dropped below the minimum.</p> <ul style="list-style-type: none"> ► Add washer fluid (► page 257). |

SmartKey

| Display messages | Possible causes/consequences and ► Solutions |
|--|---|
|  <p>Key Does Not Belong to Vehicle</p> | <p>You have put the wrong SmartKey in the ignition lock.</p> <ul style="list-style-type: none"> ► Use the correct SmartKey. |
|  <p>Take Your Key from Ignition</p> | <p>The SmartKey is in the ignition lock.</p> <ul style="list-style-type: none"> ► Remove the SmartKey. |
|  <p>Obtain a New Key</p> | <p>The SmartKey needs to be replaced.</p> <ul style="list-style-type: none"> ► Visit a qualified specialist workshop. |
|  <p>Replace Key Battery</p> | <p>The battery of the KEYLESS-GO key is discharged.</p> <ul style="list-style-type: none"> ► Change the batteries (► page 76). |
|  <p>Don't Forget Your Key</p> | <p>The KEYLESS-GO key is not in the ignition lock. You have opened the driver's door with the engine switched off.</p> <p>This display message is shown in the multifunction display for a maximum of 60 seconds and is simply a reminder.</p> <ul style="list-style-type: none"> ► Remember to take the KEYLESS-GO key with you when you leave the vehicle. |

| Display messages | Possible causes/consequences and ► Solutions |
|---|--|
|  <p>Key Not Detected (red display message)</p> | <p>The KEYLESS-GO key is not in the vehicle. A warning tone also sounds. If the engine is switched off, you can no longer lock the vehicle centrally or start the engine.</p> <ul style="list-style-type: none"> ► Pull over and stop the vehicle safely as soon as possible, paying attention to road and traffic conditions. ► Secure the vehicle against rolling away (▷ page 138). ► Locate the KEYLESS-GO key. <p>A strong source of radio waves is causing interference and this is preventing the KEYLESS-GO key from being recognized when the engine is running. A warning tone also sounds.</p> <ul style="list-style-type: none"> ► Pull over and stop the vehicle safely as soon as possible, paying attention to road and traffic conditions. ► Secure the vehicle against rolling away (▷ page 138). ► Insert the SmartKey into the ignition lock and bring into key mode. |
|  <p>Key Not Detected (white display message)</p> | <p>The KEYLESS-GO key cannot be detected at present.</p> <ul style="list-style-type: none"> ► Change the location of the SmartKey with the KEYLESS-GO functions in the vehicle. <p>If the KEYLESS-GO key is still not detected:</p> <ul style="list-style-type: none"> ► Operate the vehicle with the SmartKey in the ignition lock. |
|  <p>Remove 'Start' Button and Insert Key</p> | <p>The KEYLESS-GO key can continuously not be detected. KEYLESS-GO is temporarily malfunctioning or is defective. A warning tone also sounds.</p> <ul style="list-style-type: none"> ► Insert the SmartKey into the ignition lock and turn it to the desired position. ► Visit a qualified specialist workshop. |

Warning and indicator lamps in the instrument cluster

General notes

Some systems carry out a self-diagnosis when the ignition is switched on. Therefore, some indicator and warning lamps may light up or flash temporarily. This behavior is non-critical. These indicator and warning lamps only indicate a malfunction if they light up or flash after starting the engine or whilst driving.

Safety

Seat belts

Warning/
indicator
lamp

▷ Signal type

Possible causes/consequences and ▶ Solutions



▷ After starting the engine, the red seat belt warning lamp lights up for 6 seconds. The seat belt warning lamp reminds the driver and front passenger to fasten their seat belts.

- ▶ Fasten your seat belt (▷ page 43).



▷ After starting the engine, the red seat belt warning lamp lights up. In addition, a warning tone sounds for up to 6 seconds.

The driver's seat belt is not fastened.

- ▶ Fasten your seat belt (▷ page 43).
The warning lamp goes out and the warning tone ceases.



▷ The red seat belt warning lamp lights up after the engine starts, as soon as the driver's or the front-passenger door is closed.

The driver or front passenger has not fastened their seat belt.

- ▶ Fasten your seat belt (▷ page 43).
The warning lamp goes out.

There are objects on the front-passenger seat.

- ▶ Remove the objects from the front-passenger seat and stow them in a secure place.
The warning lamp goes out.



▷ The red seat belt warning lamp flashes and an intermittent audible warning sounds.















The driver or front passenger has not fastened their seat belt. The vehicle is being driven faster than 15 mph (25 km/h) or has briefly been driven faster than 15 mph (25 km/h).

- ▶ Fasten your seat belt (▷ page 43).
The warning lamp goes out and the intermittent warning tone ceases.

There are objects on the front-passenger seat. The vehicle is being driven faster than 15 mph (25 km/h) or has briefly been driven faster than 15 mph (25 km/h).

- ▶ Remove the objects from the front-passenger seat and stow them in a secure place.
The warning lamp goes out and the intermittent warning tone ceases.

Safety systems

| Warning/ indicator lamp | ▷ Signal type Possible causes/consequences and ▶ Solutions |
|---|---|
|   | <p>▷  (USA only) or  (Canada only): the red brake system warning lamp is lit while the vehicle is moving. A warning tone also sounds. You are driving with the parking brake applied.</p> <p>▶ Release the parking brake. The warning lamp goes out and the warning tone ceases.</p> |
|   | <p>▷  (USA only) or  (Canada only): the red brake system warning lamp is lit while the engine is running. A warning tone also sounds.</p> <p> WARNING</p> <p>The brake boosting effect is malfunctioning and the braking characteristics may be affected. There is a risk of an accident.</p> <p>▶ Pull over and stop the vehicle safely as soon as possible, paying attention to road and traffic conditions. Do not continue driving under any circumstances.</p> <p>▶ Secure the vehicle against rolling away (▷ page 138).</p> <p>▶ Consult a qualified specialist workshop.</p> <p>▶ Observe the additional display messages in the multifunction display.</p> |
|   | <p>▷  (USA only) or  (Canada only): the red brake system warning lamp is lit while the engine is running. A warning tone also sounds.</p> <p> WARNING</p> <p>There is not enough brake fluid in the brake fluid reservoir. The braking effect may be impaired. There is a risk of an accident.</p> <p>▶ Pull over and stop the vehicle safely as soon as possible, paying attention to road and traffic conditions. Do not continue driving under any circumstances.</p> <p>▶ Secure the vehicle against rolling away (▷ page 138).</p> <p>▶ Do not add brake fluid. Adding more will not correct the malfunction.</p> <p>▶ Consult a qualified specialist workshop.</p> <p>▶ Observe the additional display messages in the multifunction display.</p> |

Warning/
indicator
lamp

▷ Signal type

Possible causes/consequences and ► Solutions



▷ The yellow ABS warning lamp is lit while the engine is running. ABS (anti-lock braking system) is malfunctioning. If there is an additional warning tone, the EBD (electronic brake force distribution) is malfunctioning. Other driving systems and driving safety systems may also be faulty.

WARNING

The brake system continues to function normally, but without the functions listed above. The front and rear wheels could therefore lock if you brake hard, for example.

The steerability and braking characteristics may be severely affected. The braking distance in an emergency braking situation can increase.

If ESP® is not operational, ESP® is unable to stabilize the vehicle.

There is an increased risk of skidding and an accident.

- ▶ Observe the additional display messages in the multifunction display.
- ▶ Drive on carefully.
- ▶ Visit a qualified specialist workshop immediately.

If the ABS control unit is faulty, there is also a possibility that other systems, such as the navigation system or the automatic transmission, will not be available.



▷ (USA only) or (Canada only): the red brake system warning lamp and the yellow ESP®, ESP® OFF and ABS warning lamps are lit while the engine is running.

ABS and ESP® are malfunctioning.

Other driving systems and driving safety systems may also be faulty.

WARNING



The brake system continues to function normally, but without the functions listed above. The front and rear wheels could therefore lock if you brake hard, for example.

The steerability and braking characteristics may be severely affected. The braking distance in an emergency braking situation can increase.

If ESP® is not operational, ESP® is unable to stabilize the vehicle.

There is an increased risk of skidding and an accident.

- ▶ Observe the additional display messages in the multifunction display.
- ▶ Drive on carefully.
- ▶ Visit a qualified specialist workshop immediately.

| Warning/ indicator lamp | ▶ Signal type Possible causes/consequences and ▶ Solutions |
|---|---|
|  | <p>▶ The yellow ESP[®] warning lamp flashes while the vehicle is in motion. ESP[®] or the traction control system has intervened because there is a risk of skidding or at least one wheel has started to spin. Cruise control or DISTRONIC PLUS is deactivated.</p> <ul style="list-style-type: none"> ▶ When pulling away, only depress the accelerator pedal as far as necessary. ▶ Ease off the accelerator pedal while the vehicle is in motion. ▶ Adapt your driving style to suit the road and weather conditions. ▶ Do not deactivate ESP[®]. <p>In rare cases (▶ page 68), it may be best to deactivate ESP[®]. Observe the important safety notes on ESP[®] (▶ page 67).</p> |
|  | <p>▶ The yellow ESP[®] OFF warning lamp is lit while the engine is running. ESP[®] is deactivated.</p> <p> WARNING</p> <p>If ESP[®] is switched off, ESP[®] is unable to stabilize the vehicle. Further driving systems or driving safety systems are thus restricted, e.g. Active Blind Spot Assist. The system does not perform course-correcting brake applications.</p> <p>There is an increased risk of skidding and an accident.</p> <ul style="list-style-type: none"> ▶ Reactivate ESP[®]. <p>In rare cases (▶ page 68), it may be best to deactivate ESP[®]. Observe the important safety notes on ESP[®] (▶ page 67).</p> <ul style="list-style-type: none"> ▶ Adapt your driving style to suit the road and weather conditions. <p>If ESP[®] cannot be activated:</p> <ul style="list-style-type: none"> ▶ Drive on carefully. ▶ Contact a qualified specialist workshop and have ESP[®] checked. |

**Warning/
indicator
lamp****▷ Signal type****Possible causes/consequences and ► Solutions**

▷ The yellow ESP[®] and ESP[®] OFF warning lamps are lit while the engine is running. ESP[®] is malfunctioning.
Other driving systems and driving safety systems may also be faulty.

⚠ WARNING

The brake system continues to function normally, but without the functions listed above.

The braking distance in an emergency braking situation can thus increase.

If ESP[®] is not operational, ESP[®] is unable to stabilize the vehicle.

There is an increased risk of skidding and an accident.

- ▶ Observe the additional display messages in the multifunction display.
- ▶ Drive on carefully.
- ▶ Visit a qualified specialist workshop immediately.



▷ The red restraint system warning lamp is lit while the engine is running. The restraint system is faulty.





⚠ WARNING

The air bags or Emergency Tensioning Devices may either be triggered unintentionally or, in the event of an accident, may not be triggered.

There is an increased risk of injury.

- ▶ Observe the additional display messages in the multifunction display.
- ▶ Drive on carefully.
- ▶ Have the restraint system checked immediately at a qualified specialist workshop.

Observe the additional information on restraint systems (▷ page 40).

| Engine | |
|---|---|
| Warning/ indicator lamp | ▷ Signal type Possible causes/consequences and ► Solutions |
|  | <p>▷ The yellow Check Engine warning lamp lights up while the engine is running. There may be a malfunction, for example:</p> <ul style="list-style-type: none"> • in the engine management • in the fuel injection system • in the exhaust system • in the ignition system • in the fuel system <p>The emission limit values may be exceeded and the engine may be in emergency mode.</p> <p>► Visit a qualified specialist workshop immediately.</p> <p>i In some states, you must immediately visit a qualified specialist workshop as soon as the yellow Check Engine warning lamp lights up. This is due to the legal requirements in effect in these states. If in doubt, check whether such legal regulations apply in the state in which you are currently driving.</p> |
|  | <p>▷ The yellow reserve fuel warning lamp lights up while the engine is running. The fuel level has dropped into the reserve range.</p> <p>► Refuel at the nearest gas station.</p> |
|  | <p>▷ The yellow reserve fuel warning lamp flashes while the vehicle is in motion. In addition, the  Check Engine warning lamp may light up. The fuel filler cap is not closed correctly or the fuel system is leaking.</p> <p>► Check that the fuel filler cap is correctly closed.</p> <p>► If the fuel filler cap is not correctly closed: close the fuel filler cap.</p> <p>► If the fuel filler cap is closed: visit a qualified specialist workshop.</p> |
|  | <p>▷ The red coolant warning lamp lights up while the engine is running and the coolant temperature gage is at the start of the scale. The temperature sensor for the coolant temperature gage is defective. The coolant temperature is no longer being monitored. There is a risk of engine damage if the coolant temperature is too high.</p> <p>► Pull over and stop the vehicle safely and switch off the engine, paying attention to road and traffic conditions. Do not continue driving under any circumstances.</p> <p>► Secure the vehicle against rolling away (▷ page 138).</p> <p>► Consult a qualified specialist workshop.</p> |

Warning/
indicator
lamp

▷ Signal type

Possible causes/consequences and ► Solutions



▷ The red coolant warning lamp comes on while the engine is running.

The coolant level is too low.

If the coolant level is correct, the airflow to the engine radiator may be blocked or the electric engine radiator fan may be malfunctioning.

The coolant is too hot and the engine is no longer being cooled sufficiently.

- ▶ Observe the additional display messages in the multifunction display.
- ▶ Pull over and stop the vehicle safely and switch off the engine, paying attention to road and traffic conditions.
- ▶ Secure the vehicle against rolling away (▷ page 138).
- ▶ Leave the vehicle and keep a safe distance from the vehicle until the engine has cooled down.
- ▶ Check the coolant level and add coolant, observing the warning notes (▷ page 256).
- ▶ If you have to add coolant frequently, have the engine cooling system checked.
- ▶ Make sure that the air supply to the engine radiator is not blocked, e.g. by snow, slush or ice.
- ▶ Do not start the engine again until the coolant temperature is below 248 °F (120 °C). Otherwise, the engine could be damaged.
- ▶ Drive to the nearest qualified specialist workshop.
- ▶ Avoid subjecting the engine to heavy loads, e.g. driving in mountainous terrain, and stop-and-go traffic.



▷ The red coolant warning lamp comes on while the engine is running. A warning tone also sounds.

The coolant temperature has exceeded 248 °F (120 °C). The airflow to the engine radiator may be blocked or the coolant level may be too low.

WARNING

The engine is not being cooled sufficiently and may be damaged.

Do not drive when your engine is overheated. This can cause some fluids which may have leaked into the engine compartment to catch fire.

Steam from the overheated engine can also cause serious burns which can occur just by opening the hood.

There is a risk of injury.

- ▶ Observe the additional display messages in the multifunction display.
- ▶ Pull over and stop the vehicle safely and switch off the engine, paying attention to road and traffic conditions.
- ▶ Secure the vehicle against rolling away (▷ page 138).
- ▶ Leave the vehicle and keep a safe distance from the vehicle until the engine has cooled down.
- ▶ Check the coolant level and add coolant, observing the warning notes (▷ page 256).
- ▶ If you have to add coolant frequently, have the engine cooling system checked.
- ▶ Make sure that the air supply to the engine radiator is not blocked, e.g. by snow, slush or ice.

| | |
|--|---|
| Warning/ indicator lamp | ▷ Signal type |
| | Possible causes/consequences and ▶ Solutions |

- ▶ At coolant temperatures below 248 °F (120 °C), drive to the nearest qualified specialist workshop.
- ▶ Avoid subjecting the engine to heavy loads, e.g. driving in mountainous terrain, and stop-and-go traffic.

Driving systems

| | |
|--|---|
| Warning/ indicator lamp | ▷ Signal type |
| | Possible causes/consequences and ▶ Solutions |

 ▷ The red distance warning lamp lights up while the vehicle is in motion. A warning tone also sounds.

You are approaching a vehicle, a pedestrian or a stationary obstacle in your line of travel at too high a speed.

- ▶ Be prepared to brake immediately.
- ▶ Pay careful attention to the traffic situation. You may have to brake or take evasive action.

Observe the additional information on PRE-SAFE® Brake (▷ page 69).

Observe the additional information on the distance warning function of COLLISION PREVENTION ASSIST PLUS (▷ page 65).

Tires

Warning/
indicator
lamp

▷ Signal type

Possible causes/consequences and ► Solutions



▷ The yellow combination low tire pressure telltale/TPMS malfunction telltale for the TPMS (pressure loss or malfunction) is lit.

The tire pressure monitor has detected a loss of pressure in at least one of the tires.

 **WARNING**

Tire pressures that are too low pose the following hazards:

- they may burst, especially as the load and vehicle speed increase.
- they may wear excessively and/or unevenly, which may greatly impair tire traction.
- the driving characteristics, as well as steering and braking, may be greatly impaired.

There is a risk of an accident.

- ▶ Stop the vehicle without making any sudden steering or braking maneuvers. Pay attention to the traffic conditions as you do so.
- ▶ Secure the vehicle against rolling away (▷ page 138).
- ▶ Observe the additional display messages in the multifunction display.
- ▶ Check the tires and, if necessary, follow the instructions for a flat tire (▷ page 266).
- ▶ Check the tire pressure (▷ page 287).
- ▶ If necessary, correct the tire pressure.



▷ The yellow tire pressure monitor warning lamp (pressure loss/malfunction) flashes for approximately one minute and then remains lit.

The tire pressure monitor is faulty.

 **WARNING**

The system is possibly unable to recognize or register low tire pressure.

There is a risk of an accident.

- ▶ Observe the additional display messages in the multifunction display.
- ▶ Visit a qualified specialist workshop immediately.

General notes

The multimedia system section in this manual describes the basic principles for operation. More information can be found in the Digital Operator's Manual.

Important safety notes

WARNING

If you operate information systems and communication equipment integrated in the vehicle while driving, you will be distracted from traffic conditions. You could also lose control of the vehicle. There is a risk of an accident.

Only operate the equipment when the traffic situation permits. If you are not sure that this is possible, park the vehicle paying attention to traffic conditions and operate the equipment when the vehicle is stationary.

You must observe the legal requirements for the country in which you are currently driving when operating the multimedia system.

The multimedia system calculates the route to the destination without taking the following into account, for example:

- traffic lights
- stop and yield signs
- parking or stopping restrictions
- road narrowing
- other road and traffic rules and regulations

The multimedia system may give incorrect navigation recommendations if the actual street/traffic situation does not correspond with the digital map's data.

For example:

- a diverted route
- the road layout or the direction of a one-way street has been changed

For this reason, you must always observe road and traffic rules and regulations during your journey. Road and traffic rules and regulations always have priority over multimedia system driving recommendations.

Navigation announcements are intended to direct you while driving without diverting your attention from the road and driving.

Please always use this feature instead of consulting the map display for directions. Looking at the icons or map display can distract you from traffic conditions and driving, and increase the risk of an accident.

This equipment complies with FCC radiation exposure limits set forth for uncontrolled equipment and meets the FCC radio frequency (RF) Exposure Guidelines in Supplement C to OET65.

This equipment has very low levels of RF energy that is deemed to comply without maximum permissive exposure evaluation (MPE). But it is desirable that it should be installed and operated with at least 8 inches (20 cm) and more between the radiator and a person's body (excluding extremities: hands, wrists, feet and legs.)

WARNING

Modifications to electronic components, their software as well as wiring can impair their function and/or the function of other networked components. In particular, systems relevant to safety could also be affected. As a result, these may no longer function as intended and/or jeopardize the operating safety of the vehicle. There is an increased risk of an accident and injury.

Never tamper with the wiring as well as electronic components or their software. You should have all work to electrical and electronic equipment carried out at a qualified specialist workshop.

If you make any changes to the vehicle electronics, the general operating permit is rendered invalid.

Function restrictions

For safety reasons, some functions are restricted or unavailable while the vehicle is in motion. You will notice this, for example, because either you will not be able to select certain menu items or a message will appear to this effect.

Operating system

Overview

General notes

! Do not use the space in front of the display for storage. Objects placed here could damage the display or impair its function. Avoid any direct contact with the display surface. Pressure on the display surface may result in impairments to the display, which could be irreversible.

Wearing polarized sunglasses may impair your ability to read the display.

The display has an automatic temperature-controlled switch-off feature. The brightness is automatically reduced if the temperature is too high. The display may temporarily switch off completely.

Cleaning instructions

! Do not touch the display. The display has a very sensitive high-gloss surface; there is a risk of scratching. If you have to clean the screen, however, use a mild cleaning agent and a soft, lint-free cloth.

The display must be switched off and have cooled down before you start cleaning. Do not apply pressure to the display surface when cleaning it, as this could cause irreversible damage to the display.

Switching the multimedia system on/off

▶ Press the  control knob.



Adjusting the volume

▶ Turn the  control knob.

The volume is adjusted:

- for the currently selected media source
- during traffic or navigation announcements
- in hands-free mode during a phone call

Switching the sound on or off

▶ Press the  button on the control panel. If the audio output is switched off, the status line will show the  symbol. If you switch

the media source or set the volume, the sound is automatically switched on.

i Navigation announcements will be heard even if the sound is muted.

Functions

The multimedia system has the following functions:





- Radio mode
- Media mode with media search
- Sound systems
- Navigation system
COMAND: navigation via the hard drive
Audio 20: navigation via SD card
- Communication functions
- SIRIUS Weather (COMAND)
- Vehicle functions with system settings
- Favorites functions

Controller

The controller in the center console lets you:

- select menu items on the display
- enter characters
- select a destination on the map
- save entries

The controller can be:

- turned 
- slid left or right 
- slid forwards or back 
- slid diagonally 
- pressed briefly or pressed and held 

Back button

You can use the  button to exit a menu or to call up the basic display of the current operating mode.



▶ **To exit the menu:** briefly press the  button.

The multimedia system changes to the next higher menu level in the current operating mode.

▶ **To call up the basic display:** press the  button for longer than two seconds. The multimedia system changes to the basic display of the current operating mode.

Favorites



Calling up and exiting favorites

- ▶ **To call up:** press the  button on the controller.
- ▶ Select a favorite, e.g. **Vehicle**.
The favorites are displayed.
- ▶ **To exit:** press the  button again.

Adding favorites

Adding a predefined favorite



- ① Adds a new favorite
 - ② Renames a selected favorite
 - ③ Moves a selected favorite
 - ④ Deletes a selected favorite
- ▶ Press the  button.
 - ▶ Slide  the controller.
The menu bar is shown.
 - ▶ Select **Reassign**.
The categories are displayed.
 - ▶ Select a category.
The favorites are displayed.
 - ▶ Select a favorite.
 - ▶ Add a favorite at the desired position.
If a favorite has already been added at this position, it will be overwritten.

Adding your own favorite

- ▶ Select **Vehicle** → **Climate Control**.
- ▶ Press and hold the  button until the favorites are displayed.
- ▶ Add a favorite at the desired position.
If a favorite has already been added at this position, it will be overwritten.

Navigation mode

Important safety notes

WARNING

If you operate information systems and communication equipment integrated in the vehicle while driving, you will be distracted from traffic conditions. You could also lose control of the vehicle. There is a risk of an accident.

Only operate the equipment when the traffic situation permits. If you are not sure that this is possible, park the vehicle paying attention to traffic conditions and operate the equipment when the vehicle is stationary.

You must observe the legal requirements for the country in which you are currently driving when operating the navigation system.

General notes

Among other things, correct functioning of the navigation system depends on GPS reception. In certain situations, GPS reception may be impaired, there may be interference or there may be no reception at all, e.g. in tunnels or parking garages.

Audio 20 is equipped with MARGIN® MAP PILOT (see the manufacturer's operating instructions). The Garmin® MAP PILOT operating instructions are stored on the SD memory card as a PDF file. The SD card box contains a quick guide.

The following descriptions apply to navigation with COMAND. Further information can be found in the Digital Operator's Manual.

Selecting a route type and route options

Multimedia system:

- ▶ Select **Navi** → **Navigation**.
The map shows the vehicle's current position.
- ▶ Slide  the controller.
- ▶ Select **Options** → **Route Settings**.

Notes for route types:

- **Eco Route**
- **Dynamic Traffic Route** (only available in the USA and Canada)
Traffic reports on the route for the route guidance are taken into account.

- **Dynamic TRF. Route After Request** (only available in the USA and Canada)

You can decide whether or not current traffic reports should be taken into account for route calculation.

- **Calculate Alternative Routes**

Different routes are being calculated. In order to do so, instead of **Start**, select the menu item **Continue**.

Notes for route options:

- **Use Toll Roads**

The route calculation includes roads which require you to pay a usage fee (toll).

- **Number of Occupants in the Vehicle:** (only available in the USA)

Prerequisite: your vehicle meets the access conditions for carpool lanes.



Carpool lanes will be included if the carpool lanes option is activated.

Entering an address

Multimedia system:

- ▶ Select **Navi** → **Navigation**.
The map shows the vehicle's current position.
- ▶ Slide  the controller.
- ▶ Select **Destination** → **Address Entry**.

Enter an address, e.g. as follows:

- city or ZIP code, street, house number
- state/province, city or ZIP code
- city or ZIP code, center
- street, city or ZIP code, intersection
- ▶ Select **City**.
The city in which the vehicle is currently located (current vehicle position) is at the top. Below this, you will see locations for which route guidance has already been carried out.
- ▶ Enter the city.
The  symbol: the location is contained on the digital map multiple times.
- ▶ **To switch to the list:** slide the  control-ler.
- ▶ Select the location.
If available, the zip code is shown. If there are different ZIP codes available for the location, the corresponding digits are displayed with an **X**.
- ▶ Enter the street and house number.
The address is in the menu.

Further options for destination entry:

- search for a keyword
The keyword search finds destinations using fragments of words.
- select the last destination
- select a contact
- select a POI
You can search for a POI by location, name or telephone number.
- select destination on the map
- enter intermediate destination
You can map the route to the destination yourself with up to four intermediate destinations.
- select destinations from Mercedes-Benz Apps
- select geo-coordinates

Calculating the route

Prerequisite: the address has been entered and is in the menu.

- ▶ Select **Start** or **Continue**.
The route is calculated with the selected route type and the selected route options.
If route guidance has already been activated, a prompt will appear asking whether you wish to end the current route guidance.
- ▶ Select **Yes** or **Set as Intermediate Destination**.
Yes cancels the current route guidance and starts route calculation to the new destination.
Set as Intermediate Destination adds the new destination in addition to the existing destination and opens the intermediate destinations list.

Connecting a mobile phone

Prerequisites

For telephony via the Bluetooth® interface, you require a Bluetooth®-capable mobile phone. The mobile phone must support Hands-Free Profile 1.0 or above.

Multimedia system:

- ▶ Select **Vehicle** → **System Settings** → **Activate Bluetooth**.
- ▶ Activate Bluetooth® .

Mobile phone:

- ▶ Activate Bluetooth® and, if necessary, Bluetooth® visibility for other devices (see the manufacturer's operating instructions).

The Bluetooth® device names for all of one manufacturer's products might be identical. To make it possible to clearly identify your mobile phone, change the device name (see the manufacturer's operating instructions).

If the mobile phone supports the PBAP (Phone Book Access Profile) and MAP (Message Access Profile) Bluetooth® profiles, the following information will be transmitted after you connect:

- Phone book
- Call lists
- Text messages and e-mails

i Further information on suitable mobile phones can be obtained on the Internet at: <http://www.mercedes-benz.com/connect>

i In the USA you can also contact the Mercedes-Benz Customer Assistance Center at 1-800-FOR-MERcedes (1-800-367-6372). In Canada, you can get in touch with the Customer Relations Center on 1-800-387-0100.

Searching for and authorizing a mobile phone

Before using your mobile phone with the multimedia system for the first time, you will need to search for the phone and then authorize (connect) it. Depending on the mobile phone, authorization either takes place by means of Secure Simple Pairing or by entering a passkey. The multimedia system automatically makes the procedure that is relevant for your mobile phone available. The mobile phone is always connected automatically after authorization. Further information on using a mobile phone with the multimedia system (see the Digital Operator's Manual).

If the multimedia system does not detect your mobile phone, this may be due to particular

security settings on your mobile phone (see the manufacturer's operating instructions).

Only one mobile phone can be connected to the multimedia system at any one time.



Searching for a mobile phone

Multimedia system:

- ▶ Select **Te1**/ → **Connect Device** → **Search for Phones** → **Start Search**.

The available mobile phones are displayed.

Symbols in the device list

| Symbol | Explanation |
|---|--|
|  | New mobile phone found, not yet authorized. |
|  | Mobile phone is authorized, but is not connected |
| • | Mobile phone is authorized and connected |

Connecting a mobile phone

Authorization using Secure Simple Pairing:

- ▶ Select mobile phone.
A code is displayed in the multimedia system and on the mobile phone.
- ▶ **If codes match:** select **Yes** on the multimedia system.
- ▶ Confirm code on the mobile phone. Depending on the mobile phone used, confirm the connection to the multimedia system and for the PBAP and MAP Bluetooth® profiles. The prompt to confirm may take up to two minutes to be displayed (see the manufacturer's operating instructions).
- ▶ **If the codes are different:** select **No** on the multimedia system.
The process is canceled.
Repeat authorization.

Authorization by entering a passkey:

- ▶ Select Bluetooth® name of the mobile phone.
The input menu for the passkey is displayed.
- ▶ Choose a one to sixteen-digit number combination as a passkey.
- ▶ Enter the passkey on the multimedia system.
- ▶ Press to confirm.
- ▶ Enter and confirm the passkey on the mobile phone. Depending on the mobile phone used,

confirm the connection to the multimedia system and for the PBAP and MAP Bluetooth® profiles. The prompt to confirm may take up to two minutes to be displayed (see the manufacturer's operating instructions).

Switching between mobile phones

If you have authorized more than one mobile phone, you can switch between the individual phones.

Multimedia system:

- ▶ Select **Connect Device**.
- ▶ Select a mobile phone from the device list.

Media mode

General notes

If you wish to play external media sources, the default display must already be turned on. Further information on media mode (see the Digital Operator's Manual).

The following external media sources can be used:

- Apple® devices (e.g. iPhone®)
- USB devices (e.g. USB stick, MP3 player)
- CD
- DVD (COMAND Online)
- SD cards
- via devices connected by Bluetooth®

i Information on single CD/DVD drive or DVD changer (see the Digital Operator's Manual).

Using the device list

Multimedia system:

- ▶ Select **Media → Devices**.
The available media sources will be shown.
The • dot indicates the current setting.
- ▶ Select the media source.
Playable files are played.

Inserting/removing an SD memory card

Important safety notes

WARNING

SD memory cards are small parts. They can be swallowed and cause asphyxiation. This poses an increased risk of injury or even fatal injury.

Keep SD memory cards out of the reach of children. If an SD memory card is swallowed, seek immediate medical attention.

! If you are no longer using the SD memory card, you should remove it and take it out of the vehicle. High temperatures can damage the card.

Inserting an SD memory card

The SD card slot is on the control panel.

- ▶ Insert the SD memory card into the SD card slot until it engages. The side with the contacts must face downwards.

Ejecting an SD memory card

- ▶ Press the memory card.
The memory card is ejected.
- ▶ Remove the memory card.

Connecting USB devices

There are two USB ports in the stowage space under the armrest.

- ▶ Connect the USB device to the USB port.
- ▶ Select the media source (▶ page 234).

Stowage areas

Loading guidelines

WARNING

If objects, luggage or loads are not secured or not secured sufficiently, they could slip, tip over or be flung around and thereby hit vehicle occupants. There is a risk of injury, particularly in the event of sudden braking or a sudden change in direction.

Always store objects so that they cannot be flung around. Secure objects, luggage or loads against slipping or tipping before the journey.

WARNING

Combustion engines emit poisonous exhaust gases such as carbon monoxide. Exhaust gases can enter the vehicle interior if the trunk lid is open when the engine is running, especially if the vehicle is in motion. There is a risk of poisoning.

Always switch off the engine before opening the trunk lid. Never drive with the trunk lid open.

WARNING

The exhaust tail pipe and tail pipe trim can become very hot. If you come into contact with these parts of the vehicle, you could burn yourself. There is a risk of injury.

Always be particularly careful around the exhaust tail pipe and the tail pipe trim. Allow these components to cool down before touching them.

The handling characteristics of a laden vehicle are dependent on the distribution of the load within the vehicle. For this reason, you should observe the following notes when transporting a load:

- Never exceed the maximum permissible gross vehicle mass or the gross axle weight rating for the vehicle (including occupants). The values are specified on the vehicle iden-

tification plate on the B-pillar of the driver's door.

- The trunk is the preferred place to carry objects.
- Position heavy loads as far forwards as possible and as low down in the trunk as possible.
- The load must not protrude above the upper edge of the seat backrests.
- Always place the load against the rear or front seat backrests. Make sure that the seat backrests are securely locked into place.
- Always place the load behind unoccupied seats if possible.
- Use the cargo tie-down rings and the parcel nets to transport loads and luggage.
- Use cargo tie-down rings and fastening materials appropriate for the weight and size of the load.
- Secure the load with sufficiently strong and wear-resistant tie-downs. Pad sharp edges for protection.

Stowage spaces

Important safety notes

WARNING

If objects in the passenger compartment are stowed incorrectly, they can slide or be thrown around and hit vehicle occupants. In addition, cupholders, open stowage spaces and mobile phone brackets cannot always retain all objects they contain. There is a risk of injury, particularly in the event of sudden braking or a sudden change in direction.

- Always stow objects so that they cannot be thrown around in such situations.
- Always make sure that objects do not protrude from stowage spaces, parcel nets or stowage nets.
- Close the lockable stowage spaces before starting a journey.
- Always stow and secure heavy, hard, pointed, sharp-edged, fragile or bulky objects in the trunk.

Observe the loading guidelines (▷ page 235).

Glove box



- ▶ **To open:** pull handle ① and open glove box flap ②.
- ▶ **To close:** fold glove box flap ② upwards until it engages.

i The glove box can be ventilated (> page 120).



The glove box can only be locked and unlocked using the mechanical key.

- ▶ **To lock:** insert the mechanical key into the lock and turn it 90° clockwise to position ②.
- ▶ **To unlock:** insert the mechanical key into the lock and turn it 90° counter-clockwise to position ①.

Stowage compartment in the center console



- ▶ Briefly press trim ② in the direction of the arrow. Cover ① swings upwards.

Stowage compartment under the armrest



- ▶ **To open:** press left-hand button ② or right-hand button ①. The stowage compartment opens.

i An additional stowage compartment is located in the armrest.

Depending on the vehicle's equipment, the following may be in the stowage compartment: a multimedia connector unit with an SD card slot and 2 USB ports (Media Interface), e.g. for use with an iPod®, iPhone® or MP3 player; see the separate operating instructions.

Stowage compartment under the front seats

WARNING

If you exceed the maximum load for the stowage compartment, the cover may not be able

to restrain the items. Items may be thrown out of the stowage compartment and hit vehicle occupants. There is a risk of injury, particularly in the event of sudden braking or a sudden change in direction.

Never exceed the maximum permissible load for the stowage compartment. Stow and secure heavy objects in the trunk.

The maximum permissible load of the stowage compartment is 3.3 lbs (1.5 kg).



- **To open:** pull handle ① up and fold cover ② forwards.

Stowage nets

Stowage nets are located in the front-passenger footwell and on the left-hand side of the trunk. Observe the loading guidelines (▷ page 235) and the safety notes regarding stowage spaces (▷ page 235).

Rear bench seat through-loading feature

Important safety notes

WARNING

If the rear bench seat/rear seat and seat backrest are not engaged they could fold forwards, e.g. when braking suddenly or in the event of an accident.

- The vehicle occupant would thereby be pushed into the seat belt by the rear bench seat/rear seat or by the seat backrest. The seat belt can no longer offer the intended

level of protection and could even cause injuries.

- Objects or loads in the trunk cannot be restrained by the seat backrest.

There is an increased risk of injury.

Before every trip, make sure that the seat backrests and the rear bench seat/rear seat are engaged.

Observe the loading guidelines (▷ page 235). The left-hand and right-hand rear seat backrests can be folded down separately to increase the trunk capacity.

Folding the seat backrest forward



- ① Vehicles with memory function: when you fold one or both parts of the rear seat backrest forwards, the respective front seat moves forward slightly, when necessary, in order to avoid contact.
- Vehicles without memory function: if necessary, move the driver's or front-passenger seat forward.
- Open the trunk.
- Pull right-hand or left-hand rear seat backrest release handle ①. The corresponding rear seat backrest is released.



- ▶ Fold rear seat backrest ② forwards.
- ▶ Move the driver's or front-passenger seat back if necessary.

Folding the seat backrest back

- ! Make sure that the seat belt does not become trapped when folding the rear seat backrest back. Otherwise, it could be damaged.

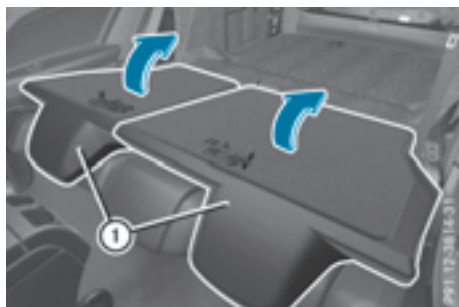

- ▶ Move the driver's or front-passenger seat forward if necessary.
 - ▶ Fold rear seat backrest ① back until it engages.
If the rear seat backrest is not engaged and locked, this will be shown in the multifunction display in the instrument cluster. A warning tone also sounds.
 - ▶ Move the driver's or front-passenger seat back if necessary.
- i** You should always engage the rear seat backrests if you do not need the through-loading feature. This will prevent unauthorized access to the trunk from the vehicle interior.

Securing cargo

Cargo tie-down rings

General notes

Observe the following notes on securing loads:

- Observe the loading guidelines (▷ page 235).
- Secure the load using the cargo tie-down rings.
- Distribute the load on the cargo tie-down rings evenly.
- Do not use elastic straps or nets to secure a load, as these are only intended as an anti-slip protection for light loads.
- Do not route tie-downs across sharp edges or corners.
- Pad sharp edges for protection.

Trunk

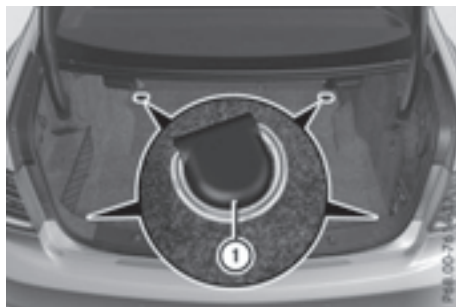

- ▶ Fold up cargo tie-down rings ① next to the rear seat backrest and put them through the slots in the carpet.

Bag hook

! WARNING

The bag hooks cannot restrain heavy objects or items of luggage. Objects or items of luggage could be flung around and thereby hit vehicle occupants when braking or abruptly changing directions. There is a risk of injury.

Only hang light objects on the bag hooks. Never hang hard, sharp-edged or fragile objects on the bag hooks.

- ! The bag hook can bear a maximum load of 6.6lbs (3kg) and should not be used to secure a load.



① Bag hook

Stowage well under the trunk floor

! Unhook the handle before again before closing the trunk lid and clip it in securely to prevent the handle flap from protruding. Otherwise, you could damage the handle.

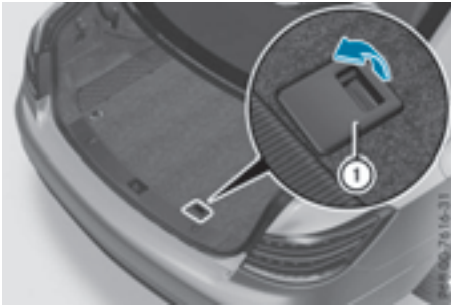

The TIREFIT kit, the vehicle tool kit, etc. are located in the stowage compartment.

► **To open:** pull handle ① up.

Roof carrier

Important safety notes

⚠ WARNING

When you load the roof, the center of gravity of the vehicle rises and the driving characteristics change. If you exceed the maximum roof load, the driving characteristics, as well as steering and braking, will be greatly impaired. There is a risk of an accident.

Never exceed the maximum roof load and adjust your driving style.

! Mercedes-Benz recommends that you only use roof carriers that have been tested and approved for Mercedes-Benz vehicles. This helps to prevent damage to the vehicle.

Position the load on the roof rack in such a way that the vehicle will not sustain damage even when it is in motion.

Depending on the vehicle equipment, ensure that when the roof carrier is installed you can:

- open the panorama roof with power tilt/sliding panel fully
- open the trunk lid fully

! To avoid damaging or scratching the covers, do not use metallic or hard objects to open them.

You will find information on the maximum roof load in the "Technical data" section (> page 313).

An incorrectly secured roof carrier or roof load may become detached from the vehicle. You must therefore ensure that you observe the roof carrier manufacturer's installation instructions.

Attaching the roof carrier



Vehicles with a steel roof



Vehicles with a panorama roof with power tilt/sliding panel

- ▶ Open covers ① carefully in the direction of the arrow.
- ▶ Fold covers ① upwards.
- ▶ Only secure the roof carrier to the anchorage points under covers ①.
- ▶ Observe the manufacturer's installation instructions.

Features

Cup holder

Important safety notes

WARNING

If objects in the passenger compartment are stowed incorrectly, they can slide or be thrown around and hit vehicle occupants. In addition, cupholders, open stowage spaces and mobile phone brackets cannot always retain all objects they contain. There is a risk of injury, particularly in the event of sudden braking or a sudden change in direction.

- Always stow objects so that they cannot be thrown around in such situations.
- Always make sure that objects do not protrude from stowage spaces, parcel nets or stowage nets.
- Close the lockable stowage spaces before starting a journey.
- Always stow and secure heavy, hard, pointed, sharp-edged, fragile or bulky objects in the trunk.

! Do not expose drinks bottles in the cup holder in the center console to continuous, strong and direct sunlight. The passenger compartment in the area of the center console can otherwise be damaged by the concentrated and reflected sunlight.

Observe the loading guidelines (▶ page 235).

Cup holder in the front-compartment center console



① Cup holder

You can remove the cup holder's rubber mat for cleaning. Clean with clear, lukewarm water only.

Cup holder in the rear stowage box



▶ **To open:** slide cover ① forwards.

Sun visors

Overview

WARNING

If the mirror cover of the vanity mirror is folded up when the vehicle is in motion, you could be blinded by incident light. There is a risk of an accident.

Always keep the mirror cover folded down while driving.

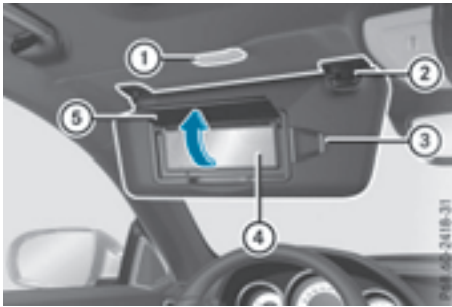

- ① Mirror light
- ② Bracket
- ③ Retaining clip, e.g. for a car park ticket
- ④ Vanity mirror
- ⑤ Mirror cover

Vanity mirror in the sun visor

Mirror light ① only functions if the sun visor is clipped into bracket ② and mirror cover ⑤ has been folded up.

Glare from the side

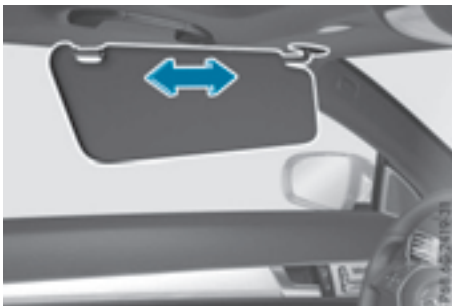

- ▶ Pull or push the sun visor in the direction of the arrow.

Rear window roller sunblind

Important safety notes

WARNING

Parts of the body could be trapped in the sweep of the roller sunblind when the roller sunblind is extended or retracted. There is a risk of injury.

When extending or retracting make sure that no parts of the body are in the sweep of the roller sunblind. Briefly press the button again if someone becomes trapped. The opening or closing process is briefly stopped. The roller sunblind then returns to its initial position.

- ❗ Make sure that the roller sunblind can move freely. Otherwise, the roller sunblind or other objects could be damaged.

Extending/retracting from the driver's seat



- ▶ Turn the SmartKey to position 1 or 2 in the ignition lock (▷ page 122).
- ▶ **To extend or retract:** briefly press button ①. The roller sunblind fully extends or fully retracts.
- ▶ **To stop:** briefly press button ① again. The roller sunblind stops briefly and moves back into the out-of-use position.

Ashtray

Front ashtray

- ❗ The stowage space under the ashtray is not heat resistant. Before placing lit cigarettes in the ashtray, make sure that the ashtray is properly engaged. Otherwise, the stowage space could be damaged.

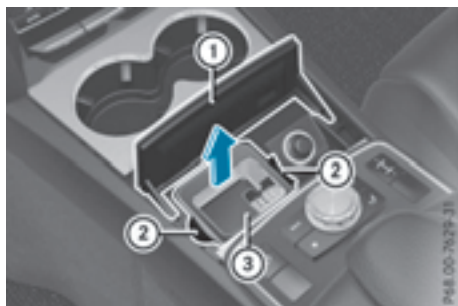

- ▶ **To open:** open the stowage compartment (▷ page 236).
- ▶ **To remove the insert:** grip recesses ② and lift insert ③ up and out.
- ▶ **To re-install the insert:** press insert ③ into the holder until it engages.
- ▶ **To close:** press stowage compartment cover ① down until it engages.

You can remove the ashtray insert and use the resulting compartment for stowage.

Rear-compartment ashtray



- ▶ **To open:** pull cover ② out by its top edge.
- ▶ **To remove the insert:** press release button ③ and lift the insert up and out.
- ▶ **To install the insert:** install insert ① from above into the holder and press down into the holder until it engages.

Cigarette lighter

Important safety notes

WARNING

You can burn yourself if you touch the hot heating element or the socket of the cigarette lighter.

In addition, flammable materials can ignite if:

- the hot cigarette lighter falls
- a child holds the hot cigarette lighter to objects, for example

There is a risk of fire and injury.

Always hold the cigarette lighter by the knob. Always make sure that the cigarette lighter is out of reach of children. Never leave children unsupervised in the vehicle.

Your attention must always be focused on the traffic conditions. Only use the cigarette lighter when road and traffic conditions permit.

Cigarette lighter in the front compartment



- ▶ Turn the SmartKey to position **2** in the ignition lock (▷ page 122).
- ▶ **To open:** open the stowage compartment (▷ page 236).
- ▶ Press in cigarette lighter ②. Cigarette lighter ② will pop out automatically when the heating element is red-hot.
- ▶ **To close:** press stowage compartment cover ① down until it engages.

12 V sockets

General notes

- ▶ Turn the SmartKey to position **1** in the ignition lock (▷ page 122).

The sockets can be used for accessories with a maximum draw of 180 W (15 A). Accessories include such items as chargers for mobile phones.

If you use the sockets for long periods when the engine is switched off, the battery may discharge.

An emergency cut-out ensures that the on-board voltage does not drop too low. If the on-board voltage is too low, the power to the sockets is automatically cut. This ensures that there is sufficient power to start the engine.

Socket in the rear-compartment center console



- ▶ Pull cover (2) out by its top edge.
- ▶ Lift up the cover of socket (1).

mbrace

General notes

The mbrace system is only available in the USA. You must have a license agreement to activate the mbrace service. Make sure that your system is activated and operational. To log in, press the  MB Info call button. If any of the steps mentioned are not carried out, the system may not be activated.

If you have questions about the activation, contact one of the following telephone hotlines:

Mercedes-Benz Customer Assistance Center at 1-800-FOR-MERcedes (1-800-367-6372) or 1-866-990-9007

Shortly after successfully registering with the mbrace service, a user ID and password will be sent to you by mail. You can use this password to log onto the mbrace area under "Owners Online" at <http://www.mbusa.com>.

The system is available if:

- it has been activated and is operational
- the corresponding mobile phone network is available for transmitting data to the Customer Center



- a service subscription is available

Determining the location of the vehicle on a map is only possible if:

- GPS reception is available.
- the vehicle position can be forwarded to the Customer Assistance Center.

The mbrace system

To adjust the volume during a call, proceed as follows:

- ▶ Press the  or  button on the multi-function steering wheel.

or

- ▶ Use the volume control on the multimedia system.

The system offers various services, e.g.:

- Automatic and manual emergency call
- Roadside Assistance call
- MB Info call



You can find information and a description of all available features under "Owners Online" at <http://www.mbusa.com>.

System self-test

After you have switched on the ignition, the system carries out a self-diagnosis.

A malfunction in the system has been detected if one of the following occurs:

- The indicator lamp in the SOS button does not come on during the system self-test.
- The indicator lamp in the  Roadside Assistance button does not light up during self-diagnosis of the system.

- The indicator lamp in the  MB Info call button does not light up during self-diagnosis of the system.
- The indicator lamp in one or more of the following buttons continues to light up red after the system self-diagnosis:
 - SOS button
 -  Roadside Assistance call button
 -  MB Info call button
- The **Inoperative** or the **Service Not Activated** message appears in the multifunction display after the system self-diagnosis.

If a malfunction is indicated as outlined above, the system may not operate as expected. In the event of an emergency, help will have to be summoned by other means.

Have the system checked at the nearest authorized Mercedes-Benz Center or contact the following service hotlines:

Mercedes-Benz Customer Assistance Center at 1-800-FOR-MERCEdes (1-800-367-6372) or 1-866-990-9007

Emergency call

Important safety notes

WARNING

It can be dangerous to remain in the vehicle, even if you have pressed the SOS button in an emergency if:

- you see smoke inside or outside of the vehicle, e.g. if there is a fire after an accident
- the vehicle is on a dangerous section of road
- the vehicle is not visible or cannot easily be seen by other road users, particularly when dark or in poor visibility conditions

There is a risk of an accident and injury.

Leave the vehicle immediately in this or similar situations as soon as it is safe to do so. Move to a safe location along with other vehicle occupants. In such situations, secure the vehicle in accordance with national regulations, e.g. with a warning triangle.

General notes

Observe the notes on system activation (▷ page 243).

An emergency call is dialed automatically if an air bag or Emergency Tensioning Device is triggered. You cannot end an automatically triggered emergency call yourself.

An emergency call can also be initiated manually.

As soon as the emergency call has been initiated, the indicator lamp in the SOS button flashes. The **Connecting Call** message appears in the multifunction display.

The audio output is muted.

Once the connection has been made, the **Call Connected** message appears in the multifunction display.

All important information on the emergency is transmitted, for example:

- current location of the vehicle (as determined by the GPS system)
- vehicle identification number
- information on the severity of the accident

Shortly after the emergency call has been initiated, a voice connection is automatically established between the Customer Assistance Center and the vehicle occupants.

- If the vehicle occupants respond, the Mercedes-Benz Customer Assistance Center attempts to get more information on the emergency.
- If there is no response from the vehicle occupants, an ambulance is immediately sent to the vehicle.

If no voice connection can be established to the Mercedes-Benz Customer Assistance Center, the system has been unable to initiate an emergency call.

This can occur, for example, if the relevant mobile phone network is not available. The indicator lamp in the SOS button flashes continuously.

The **Call Failed** message appears in the multifunction display and must be confirmed.

In this case, summon assistance by other means.

Making an emergency call



- ▶ **To initiate an emergency call manually:** press cover ① briefly to open.
- ▶ Press and hold the SOS button for at least one second ②. The indicator lamp in SOS button ② flashes until the emergency call is concluded.
- ▶ Wait for a voice connection to the Mercedes-Benz Customer Assistance Center.
- ▶ After the emergency call, close cover ①.

If the mobile phone network is unavailable, mbrace will not be able to make the emergency call. If you leave the vehicle immediately after pressing the SOS button, you will not know whether mbrace placed the emergency call. In this case, always summon assistance by other means.

Roadside Assistance button



- ▶ **To call Roadside Assistance:** press Roadside Assistance button ①. This initiates a call to the Mercedes-Benz Customer Assistance Center. The indicator lamp in Roadside Assistance button ① flashes while the call is active. The **Connecting Call** message appears in the

multifunction display. The audio output is muted.

If a connection can be made, the **Call Connected** message appears in the multifunction display.

If a mobile phone network and GPS reception are available, the system transfers data to the Mercedes-Benz Customer Assistance Center, for example:

- current location of the vehicle
- vehicle identification number

The multimedia system display indicates that a call is active. During the call, you can change to the navigation menu by pressing the NAVI button on the multimedia system, for example.

Voice output is not available in this case.

A voice connection is established between the Mercedes-Benz Customer Assistance Center and the vehicle occupants.

From the remote malfunction diagnosis, the Mercedes-Benz Customer Assistance Center can ascertain the nature of the problem (> page 248).

The Mercedes-Benz Customer Assistance Center either sends a qualified Mercedes-Benz technician or makes arrangements for your vehicle to be transported to the nearest authorized Mercedes-Benz Center.

You may be charged for services such as repair work and/or towing.

You can find more information in the separate mbrace manual.

The system has not been able to initiate a Roadside Assistance call, if:

- the indicator lamp for Roadside Assistance call button  is flashing continuously.
- no voice connection to the Mercedes-Benz Customer Assistance Center was established.

This can occur if the relevant mobile phone network is not available, for example.

The **Call Failed** message appears in the multifunction display.

- ▶ **To end a call:** press the  button on the multifunction steering wheel.

or

- ▶ Press the corresponding multimedia system button for ending a phone call.

MB Info call button



► **To call MB Info:** press MB Info call button ①.

This initiates a call to the Mercedes-Benz Customer Assistance Center.

The indicator lamp in MB Info call button ① flashes while the connection is being made. The **Connecting Call** message appears in the multifunction display. The audio output is muted.

If a connection can be made, the **Call Connected** message appears in the multifunction display.

If a mobile phone network and GPS reception are available, the system transfers data to the Mercedes-Benz Customer Assistance Center, for example:

- current location of the vehicle
- vehicle identification number

The multimedia system display indicates that a call is active. During the call, you can change to the navigation menu by pressing the NAVI button on COMAND, for example.

Voice output is not available in this case.

A voice connection is established between the Mercedes-Benz Customer Assistance Center and the vehicle occupants.

You receive information about operating your vehicle, about the nearest authorized Mercedes-Benz Center and about other products and services from Mercedes-Benz.

You can find further information on the mbrace system under "Owners Online" at <http://www.mbusa.com>.

The system has not been able to initiate an MB Info call, if:

- the indicator lamp in MB Info call button  is flashing continuously.
- no voice connection to the Mercedes-Benz Customer Assistance Center was established.

This can occur if the relevant mobile phone network is not available, for example.

The **Call Failed** message appears in the multifunction display.

► **To end a call:** press the  button on the multifunction steering wheel.

or

► Press the corresponding multimedia system button for ending a phone call.

Call priority

When service calls are active, e.g. Roadside Assistance or MB Info calls, an emergency call can still be initiated. In this case, an emergency call will take priority and override all other active calls.

The indicator lamp of the respective button flashes until the call is ended.

An emergency call can only be terminated by the Mercedes-Benz Customer Assistance Center.

All other calls can be ended by pressing:

- the  button on the multifunction steering wheel
- the corresponding button in the multimedia system to end the voice call

When a call is initiated, the audio system is muted.

The mobile phone is no longer connected to the multimedia system.

However, if you want to use your mobile phone, do so only when the vehicle is stationary and in a safe location.

Downloading destinations

Downloading destinations

Downloading destinations gives you access to a database with over 15 million points of interest (POIs). These can be downloaded on the navigation system in your vehicle. If you know the destination, the address can be downloaded. Alternatively, you can obtain the location of

Points of Interest (POIs)/important destinations in the vicinity.

Furthermore, you can download routes with up to four way points.

You are prompted to confirm route guidance to the address entered.

- ▶ Select **Yes** by turning  or sliding   to the controller and confirm with .

The system calculates the route and subsequently starts the route guidance with the address entered.

If you select **No** the address can be stored in the address book.

The destination download function is available if:

- the vehicle is equipped with a navigation system.
- the relevant mobile phone network is available and data transfer is possible.

Route Assistance

This service is part of the mbrace PLUS Package and cannot be purchased separately.

You can use the route assistance function even if the vehicle is not equipped with a navigation system.

Within the framework of this service, you receive a professional and reliable form of navigation support without having to leave your vehicle.

The customer service representative finds a suitable route depending on your vehicle's current position and the desired destination. You will then be guided live through the current route section.

Search & Send

General notes

To use "Search & Send", your vehicle must be equipped with mbrace and a navigation system. Additionally, an mbrace service subscription must be completed.

"Search & Send" is a destination entry service. A destination address which is found on Google Maps® can be transferred via mbrace directly to your vehicle's navigation system.

Specifying and sending the destination address

- ▶ Go to the website <http://maps.google.com> and enter a destination address into the entry field.

- ▶ **To send the destination address to the e-mail address of your mbrace account:** click on the corresponding button on the website.

Example:

If you select 'Send to vehicle' and then 'Mercedes-Benz', the destination address will be sent to your vehicle.

- ▶ When the "Send" dialog window appears: Enter the e-mail address you specified when setting up your mbrace account into the corresponding field.
- ▶ Click "Send".



Information on specific commands such as "Address entry" or "Send" can be found on the website.

Calling up a transmitted destination address

- ▶ Turn the SmartKey to position **2** in the ignition lock (▷ page 122).

The transmitted destination address is loaded into the vehicle's navigation system.

A display message appears, asking whether navigation should be started.

- ▶ Select **Yes** by turning  or sliding   to the controller and confirm with .

The system calculates the route and subsequently starts the route guidance with the address entered.

If you select **No** the address can be stored in the address book.

If you have sent more than one destination address, each individual destination must be confirmed separately.

Destination addresses are loaded in the same order as the order in which they were sent.

If you own multiple Mercedes-Benz vehicles with mbrace and activated mbrace accounts:

If multiple vehicles are registered under the same e-mail address, the destination will be sent to all the vehicles.

Vehicle remote opening

You can use the vehicle remote opening if you have unintentionally locked your vehicle and a replacement SmartKey is not available.

The vehicle can be opened by the Mercedes-Benz Customer Assistance Center.

The vehicle can be immediately opened remotely within four days of the ignition being turned off. After this time, the remote unlocking may be delayed by 15 to 60 minutes. After 30 days, the vehicle can no longer be opened remotely.

The vehicle remote unlocking feature is available if the relevant mobile phone network is available and a data connection is possible.

► Contact the following service hotlines:

Mercedes-Benz Customer Assistance Center at 1-800-FOR-MERCedes (1-800-367-6372) or 1-866-990-9007

You will be asked for your password.

► Return to your vehicle at the time agreed upon with the Mercedes-Benz Customer Assistance Center.

Alternatively, the vehicle can be opened via:

- the Internet, under the "Owners Online" section
- the telephone application (e. g. for iPhone®, Android)

To do this, you will need your identification number and password.

Vehicle remote closing

The vehicle remote-closing feature can be used when you have forgotten to lock the vehicle and you are no longer nearby.

The vehicle can then be locked by the Mercedes-Benz Customer Assistance Center.

The vehicle can be immediately remotely locked within four days of the ignition being turned off. After this time, remote closing may be delayed by 15 to 60 minutes. After 30 days the vehicle can no longer be locked remotely.

The vehicle remote closing feature is available if the relevant mobile phone network is available and a data connection is possible.

► Contact the following service hotlines:

Mercedes-Benz Customer Assistance Center at 1-800-FOR-MERCedes (1-800-367-6372) or 1-866-990-9007

You will be asked for your password.

The next time you are inside the vehicle and you switch on the ignition, the **Doors Locked Remotely** message appears in the multifunction display.

Alternatively, the vehicle can be locked via:

- the Internet, under the "Owners Online" section
- the telephone application (e. g. for iPhone®, Android)

To do this, you will need your identification number and password.

Stolen vehicle recovery service

If your vehicle has been stolen:

► Notify the police.

The police will issue a numbered incident report.

► This number will be forwarded to the Mercedes-Benz Customer Assistance Center together with your PIN.

The Mercedes-Benz Customer Assistance Center then tries to locate the system. The Mercedes-Benz Customer Assistance Center contacts you and the local law enforcement agency if the vehicle is located.

However, only the law enforcement agency is informed of the location of the vehicle.

If the anti-theft alarm system is activated for longer than 30 seconds, the Mercedes-Benz Customer Assistance Center is automatically notified.

Vehicle Health Check

With the Vehicle Health Check, the Customer Assistance Center can provide improved support for problems with your vehicle. During an existing call, vehicle data is transferred to the Customer Assistance Center.

The customer service representative can use the received data to decide what kind of assistance is required. You are then, for example, guided to the nearest authorized Mercedes-Benz Center or a recovery vehicle is called.

If vehicle data needs to be transferred during an MB Info call or a Roadside Assistance call, this is initiated by the Customer Assistance Center.

The **Roadside Assistance Connected** message appears in the display. If the Vehicle Health Check can be started, the **Request for Vehicle Diagnostics Received Start vehicle diagnostics?** message appears in the display.

- ▶ Press the **Yes** button to confirm the message.
- ▶ When the **Vehicle Diagnostics Please Start Ignition** message appears: turn the SmartKey to position **2** in the ignition lock (▷ page 122).
- ▶ If the **Please follow the instructions received by phone and move your vehicle to a safe position.** message appears: please follow the instructions received by phone and move your vehicle to a safe position.
The message in the display disappears.
The vehicle operating state check begins.
During this procedure, you will see the **Vehicle Diagnostics Active** message.
If you select **Cancel**, the Vehicle Health Check is canceled completely.

When the check is complete, the **Sending vehicle diagnostics data. (Voice connection may be interrupted during data transfer)** message appears. The vehicle data can now be sent.

- ▶ Press the **OK** button to confirm the message.
The voice connection with the Customer Assistance Center is terminated.
The **Vehicle Diagnostics: Transferring Data...** message appears.
The vehicle data is sent to the Customer Assistance Center.

Depending on what the customer service representative agreed with you, the voice connection is re-established after the transfer is complete. If necessary, you will be contacted at a later time by another means, e.g. by e-mail or phone.

Another function of the Vehicle Health Check is the transfer of service data to the Customer Assistance Center. If a service is due, the display shows a message to this effect together with information about any special offers at your workshop.

This information can also be called up under "Owners Online" at <http://www.mbusa.com>. Information on the data stored in the vehicle (▷ page 29).

Information on Roadside Assistance (▷ page 26).

Downloading routes

Downloading routes allows you to transfer and save predefined routes in the navigation system.

A route can be prepared and sent by either a customer service representative or under "Owners Online" at <http://www.mbusa.com>.

Each route can include up to four way points.

Once a route has been received by the navigation system, you will see the **External destination ICON POI Category Name_1 has been saved to "Previous destinations". Would you like to start navigation?** message on the multimedia system display.

The route is saved.

- ▶ **To start route guidance:** select **Yes**.
An overview of the route is shown in the display.
If you select **No**, the saved route can be called up later in the navigation menu.
- ▶ Select **Start**.
Starting route guidance.

Downloaded and saved routes can be called up again.

You can find further information in the separate multimedia system operating instructions.

Speed alert

You can define the upper speed limit, which must not be exceeded by the vehicle.

If this selected speed is exceeded by the vehicle, a message will be sent to the Customer Assistance Center. The Customer Assistance Center then forwards this information to you.

You can select the way in which you receive this information beforehand. Possible options include text message, e-mail or an automated call.

The data you receive contains the following information:

- the location where the speed limit was exceeded
- the time at which the speed limit was exceeded
- the selected speed limit which was exceeded

Geo fencing

Geo fencing allows you to select areas which the vehicle should not enter or leave. You will be informed if the vehicle crosses the boundaries of the selected areas. You can select the way in which you receive this information beforehand. Possible options include text message, e-mail or an automated call.

The area can be determined as either a circle or a polygon with a maximum of ten corners. You can specify up to ten areas simultaneously. Different settings are possible for each area.

These settings can be called up under "Owners Online" at <http://www.mbusa.com>.

Alternatively, you can trigger an MB Info call and inform the customer service representative that you wish to activate geo fencing.

Currently inactive areas can be activated by text message.

Triggering the vehicle alarm

With this function, you can trigger the vehicle's panic alarm via text message. An alarm sounds and the exterior lighting flashes. Depending on the setting, the panic alarm lasts five or ten seconds. Afterwards, the alarm switches off.

Garage door opener

General notes

The HomeLink® garage door opener integrated in the rear-view mirror allows you to operate up to three different door and gate systems.

Use the integrated garage door opener only on garage doors that:

- have safety stop and reverse features and
- meet current U.S. federal safety standards

Once programmed, the integrated garage door opener in the rear-view mirror will assume the function of the garage door system's remote control. Please also read the operating instructions for the garage door system.

When programming a garage door opener, park the vehicle outside the garage. Do not run the engine while programming.

Certain garage door drives are incompatible with the integrated garage door opener. If you have difficulty programming the integrated garage

door opener, contact an authorized Mercedes-Benz Center.

Alternatively, you can call the following telephone assistance services:

- **USA:** Mercedes-Benz Customer Assistance Center at 1-800-FOR-MERCEdes
- **Canada:** Customer Service at 1-800-387-0100
- HomeLink® hotline 1-800-355-3515 (free of charge)

More information on HomeLink® and/or compatible products is also available online at <http://www.homelink.com>.

Notes on the declaration of conformity (▷ page 27).

USA: FCC ID: CB2HMIHL4

Canada: IC: 279B-HMIHL4

Important safety notes

WARNING

When you operate or program the garage door with the integrated garage door opener, persons in the range of movement of the garage door can become trapped or struck by the garage door. There is a risk of injury.

When using the integrated garage door opener, always make sure that nobody is within the range of movement of the garage door.

WARNING

Combustion engines emit poisonous exhaust gases such as carbon monoxide. Inhaling these exhaust gases leads to poisoning. There is a risk of fatal injury. Therefore never leave the engine running in enclosed spaces without sufficient ventilation.

Programming

Programming buttons

Pay attention to the "Important safety notes" (▷ page 250).

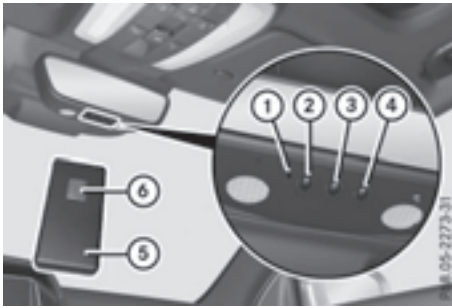

Garage door remote control ⑤ is not included with the integrated garage door opener.

▶ Turn the SmartKey to position **2** in the ignition lock (▷ page 122).

▶ Select one of buttons ② to ④ to use to control the garage door drive.

▶ **To start programming mode:** press and hold one of buttons ② to ④ on the integrated garage door opener.

The garage door opener is now in programming mode. After a short time, indicator lamp ① lights up yellow.

Indicator lamp ① lights up yellow as soon as button ②, ③ or ④ is stored for the first time. If the selected button has already been programmed, indicator lamp ① will only light up yellow after ten seconds have elapsed.

▶ Release button ②, ③ or ④. Indicator lamp ① flashes yellow.

▶ **To program the remote control:** point garage door remote control ⑤ towards buttons ② to ④ on the rear-view mirror at a distance of 2 to 8 in (5 to 20 cm).

▶ Press and hold button ⑥ on remote control ⑤ until indicator lamp ① lights up green. When indicator lamp ① lights up green: programming is finished.

When indicator lamp ① flashes green: programming was successful. The next step is to synchronize the rolling code (▷ page 251).

▶ Release button ⑥ on remote control ⑤ for the garage door drive system.

If indicator lamp ① lights up red: repeat the programming procedure for the corresponding button on the rear-view mirror. When doing so, vary the distance between remote control ⑤ and the rear-view mirror.

The required distance between remote control ⑤ and the integrated garage door opener depends on the garage door drive system.

Several attempts might be necessary. You should test every position for at least 25 seconds before trying another position.

Synchronizing the rolling code

Pay attention to the "Important safety notes" (▷ page 250).

If the garage door system uses a rolling code, you will also have to synchronize the garage door system with the integrated garage door opener in the rear-view mirror. To do this you will need to use the programming button on the door drive control panel. The programming button may be located in different places depending on the manufacturer. It is usually located on the door drive unit on the garage ceiling.

Familiarize yourself with the garage door drive operating instructions, e.g. under "Programming additional remote controls", before carrying out the following steps.

Your vehicle must be within reach of the garage door or gate opener drive. Make sure that neither your vehicle nor any persons/objects are present within the sweep of the door or gate.

▶ Turn the SmartKey to position **2** in the ignition lock (▷ page 122).

▶ Get out of the vehicle.

▶ Press the programming button on the door drive unit.

Usually, you now have 30 seconds to initiate the next step.

▶ Get into the vehicle.

▶ Press previously programmed button ②, ③ or ④ on the integrated garage door opener repeatedly and in quick succession until the door closes.

The rolling code synchronization is then complete.

Notes on programming the remote control

Canadian radio frequency laws require a "break" (or interruption) of the transmission signals after broadcasting for a few seconds. Therefore, these signals may not last long enough for the integrated garage door opener. The signal is not recognized during programming. Comparable with Canadian law, some U.S. garage door openers also feature a "break".

Proceed as follows:

- if you live in Canada
- if you have difficulties programming the garage door opener (regardless of where you live) when using the programming steps
- ▶ Press and hold one of buttons ② to ④ on the integrated garage door opener.
After a short time, indicator lamp ① lights up yellow.
- ▶ Release the button.
Indicator lamp ① flashes yellow.
- ▶ Press button ⑥ of garage door remote control ⑤ for two seconds, then release it for two seconds.
- ▶ Press button ⑥ again for two seconds.
- ▶ Repeat this sequence on button ⑥ of remote control ⑤ until indicator lamp ① lights up green.
When indicator lamp ① lights up green: programming is finished.
When indicator lamp ① flashes green: programming was successful. The next step is to synchronize the rolling code.
- ▶ Release button ⑥ of remote control ⑤ of the garage door drive.
If indicator lamp ① lights up red: repeat the programming process for the corresponding button on the rear-view mirror. When doing so, vary the distance between remote control ⑤ and the rear-view mirror.

The required distance between remote control ⑤ and the integrated garage door opener depends on the garage door drive system. Several attempts might be necessary. You should test every position for at least 25 seconds before trying another position.

Problems when programming

If you are experiencing problems programming the integrated garage door opener on the rear-view mirror, take note of the following instructions:

- Check the transmitter frequency used by garage door drive remote control ⑤ and whether it is supported. The transmitter frequency can usually be found on the back of the garage door drive remote control.
The integrated garage door opener is compatible with devices that have units which

operate in the frequency range of 280 to 433 MHz.

- Replace the batteries in garage door remote control ⑤. This increases the likelihood that garage door remote control ⑤ will transmit a strong and precise signal to the integrated garage door opener.
- When programming, hold remote control ⑤ at varying distances and angles from the button which you are programming. Try various angles at a distance between 2 and 12 inches (5 to 30 cm) or at the same angle but at varying distances.
- If another remote control is available for the same garage door drive, repeat the same programming steps with this remote control. Before performing these steps, make sure that new batteries have been installed in garage door drive remote control ⑤.
- Note that some remote controls only transmit for a limited amount of time (the indicator lamp on the remote control goes out). Press button ⑥ on remote control ⑤ again before transmission ends.
- Align the antenna cable of the garage door opener unit. This can improve signal reception/transmission.

Opening/closing the garage door

After it has been programmed, the integrated garage door opener performs the function of the garage door system remote control. Please also read the operating instructions for the garage door system.

- ▶ Turn the SmartKey to position **2** in the ignition lock (> page 122).
- ▶ Press button ②, ③ or ④ which you have programmed to operate the garage door.
Garage door system with a fixed code: indicator lamp ① lights up green.
Garage door system with a rolling code: indicator lamp ① flashes green.
The transmitter will transmit a signal as long as the button is pressed. The transmission is halted after a maximum of ten seconds and indicator lamp ① lights up yellow.
- ▶ Press button ②, ③ or ④ again if necessary.

Clearing the memory

Make sure that you clear the memory of the integrated garage door opener before selling the vehicle.

- ▶ Turn the SmartKey to position **2** in the ignition lock (▷ page 122).
- ▶ Press and hold buttons ② and ④.
The indicator lamp initially lights up yellow and then green.
- ▶ Release buttons ② and ④.
The memory of the integrated garage door opener in the rear-view mirror is cleared.

Floormats

WARNING

Objects in the driver's footwell can restrict the pedal travel or obstruct a depressed pedal. The operating and road safety of the vehicle is jeopardized. There is a risk of an accident.

Make sure that all objects in the vehicle are stowed correctly, and that they cannot enter the driver's footwell. Install the floormats securely and as specified in order to ensure sufficient clearance for the pedals. Do not use loose floormats and do not place floormats on top of one another.

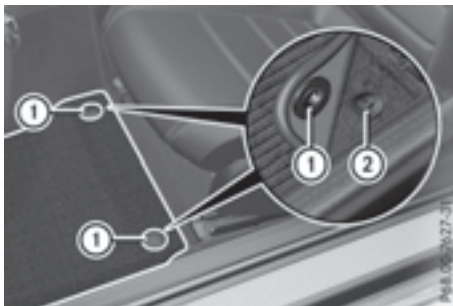

- ▶ Slide the seat backwards.
- ▶ **To install:** place the floormat in the footwell.
- ▶ Press studs ① onto retainers ②.
- ▶ **To remove:** pull the floormat off retainers ②.
- ▶ Remove the floormat.

Engine compartment

Hood

Important safety notes

WARNING

If the hood is unlatched, it may open up when the vehicle is in motion and block your view. There is a risk of an accident.

Never unlatch the hood while driving. Before every trip, ensure that the hood is locked.

WARNING

When opening and closing the hood, it may suddenly fall into the closed position. There is a risk of injury to persons within range of movement of the hood.

Open and close the hood only when no one is within its range of movement.

WARNING

Opening the hood when the engine is overheated or when there is a fire in the engine compartment could expose you to hot gases or other service products. There is a risk of injury.

Let an overheated engine cool down before opening the hood. If there is a fire in the engine compartment, keep the hood closed and contact the fire department.

WARNING

The engine compartment contains moving components. Certain components, such as the radiator fan, may continue to run or start again suddenly when the ignition is off. There is a risk of injury.

If you need to do any work inside the engine compartment:

- switch off the ignition
- never reach into the area where there is a risk of danger from moving components, such as the fan rotation area

- remove jewelry and watches
- keep items of clothing and hair, for example, away from moving parts

WARNING

The ignition system and the fuel injection system work under high voltage. If you touch components which are under voltage, you could get an electric shock. There is a risk of injury.

Never touch components of the ignition system or fuel injection system when the ignition is switched on.

Opening the hood

WARNING

Certain components in the engine compartment, such as the engine, radiator and parts of the exhaust system, can become very hot. Working in the engine compartment poses a risk of injury.

Where possible, let the engine cool down and touch only the components described in the following.

WARNING

When the hood is open and the windshield wipers are set in motion, you can be injured by the wiper linkage. There is a risk of injury.

Always switch off the windshield wipers and the ignition before opening the hood.

- ❗ Make sure that the windshield wipers are not folded away from the windshield. You could otherwise damage the windshield wipers or the hood.



- ▶ Make sure that the windshield wipers are turned off.
- ▶ Pull release lever ① on the hood. The hood is released.



- ▶ Reach into the gap, pull hood catch handle ② up and lift the hood. If you lift the hood by approximately 15 in (40 cm), the hood is opened and held open automatically by the gas-filled strut.

Closing the hood

- ▶ Lower the hood and let it fall from a height of approximately 8 in (20 cm).
- ▶ Check that the hood has engaged properly. If the hood can be raised slightly, it is not properly engaged. Open it again and close it with a little more force.

Engine oil

General notes

Depending on your driving style, the vehicle consumes up to 0.9 US qt (0.8 liters) of oil per 600 miles (1,000 km). The oil consumption may

be higher than this when the vehicle is new or if you frequently drive at high engine speeds.

Depending on the engine, the oil dipstick may be in a different location.

When checking the oil level:

- park the vehicle on a level surface.
- the engine should be switched off for approximately five minutes if the engine is at normal operating temperature.
- if the engine is not at normal operating temperature, e.g. if the engine was only started briefly, wait about 30 minutes before carrying out the measurement.

Checking the oil level using the oil dipstick

WARNING

Certain components in the engine compartment, such as the engine, radiator and parts of the exhaust system, can become very hot. Working in the engine compartment poses a risk of injury.

Where possible, let the engine cool down and touch only the components described in the following.

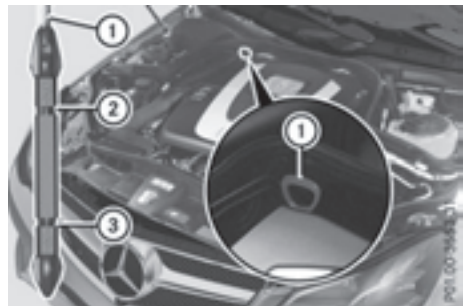

- ▶ Pull oil dipstick ① out of the dipstick guide tube.
- ▶ Wipe off oil dipstick ①.
- ▶ Slowly slide oil dipstick ① into the guide tube to the stop, and take it out again. If the level is between MIN mark ③ and MAX mark ②, the oil level is correct.
- ▶ If the oil level has dropped to MIN mark ③ or below, add 1.1 US qt (1.0 liter) of engine oil.

may vary.

Adding engine oil

WARNING

Certain components in the engine compartment, such as the engine, radiator and parts of the exhaust system, can become very hot. Working in the engine compartment poses a risk of injury.

Where possible, let the engine cool down and touch only the components described in the following.

WARNING

If engine oil comes into contact with hot components in the engine compartment, it may ignite. There is a risk of fire and injury.

Make sure that engine oil is not spilled next to the filler neck. Let the engine cool down and thoroughly clean the engine oil off the components before starting the engine.

Environmental note

When adding oil, take care not to spill any. If oil enters the soil or waterways, it is harmful to the environment.

! Only use engine oils and oil filters that have been approved for vehicles with a service system. You can obtain a list of the engine oils and oil filters tested and approved in accordance with the Mercedes-Benz Specifications for Service Products at any Mercedes-Benz Service center.

Damage to the engine or exhaust system is caused by the following:

- using engine oils and oil filters that have not been specifically approved for the service system
- replacing engine oil and oil filters after the interval for replacement specified by the service system has been exceeded
- using engine oil additives.

! Do not add too much oil. adding too much engine oil can result in damage to the engine or to the catalytic converter. Have excess engine oil siphoned off.



Example

- ▶ Turn cap ① counter-clockwise and remove it.
- ▶ Add engine oil.
If the oil level is at or below the MIN mark on the oil dipstick, add 1.1 US qt (1.0 l) of engine oil.
- ▶ Replace cap ① on the filler neck and turn clockwise.
Ensure that the cap locks into place securely.
- ▶ Check the oil level again with the oil dipstick (▷ page 255).

Further information on engine oil (▷ page 311).

Additional service products

Checking coolant level

WARNING

Certain components in the engine compartment, such as the engine, radiator and parts of the exhaust system, can become very hot. Working in the engine compartment poses a risk of injury.

Where possible, let the engine cool down and touch only the components described in the following.

WARNING

The cooling system is pressurized, particularly when the motor is warm. If you open the cap, you could be scalded if hot coolant sprays out. There is a risk of injury.

Let the engine cool down before you open the cap. Wear gloves and eye protection. Slowly open the cap to relieve pressure.



- ▶ Park the vehicle on a level surface.
Only check the coolant level when the vehicle is on a level surface and the engine has cooled down.
- ▶ Turn the SmartKey to position **2** in the ignition lock (▷ page 122).
On vehicles with KEYLESS-GO, press the Start/Stop button twice (▷ page 122).
- ▶ Check the coolant temperature display in the instrument cluster.
The coolant temperature must be below 158 °F (70 °C).
- ▶ Turn the SmartKey to position **0** in the ignition lock (▷ page 122).
- ▶ Slowly turn cap ① half a turn counter-clockwise to allow excess pressure to escape.
- ▶ Turn cap ① further counter-clockwise and remove it.
If the coolant is at the level of marker bar ③ in the filler neck when cold, there is enough coolant in coolant expansion tank ②.
If the coolant level is approximately 0.6 in (1.5 cm) above marker bar ③ in the filler neck when warm, there is enough coolant in expansion tank ②.
- ▶ If necessary, add coolant that has been tested and approved by Mercedes-Benz.
- ▶ Replace cap ① and turn it clockwise as far as it will go.

For further information on coolant, see (▷ page 312).

Adding washer fluid to the windshield washer system

WARNING

Certain components in the engine compartment, such as the engine, radiator and parts of the exhaust system, can become very hot.

Working in the engine compartment poses a risk of injury.

Where possible, let the engine cool down and touch only the components described in the following.

WARNING

Windshield washer concentrate could ignite if it comes into contact with hot engine components or the exhaust system. There is a risk of fire and injury.

Make sure that no windshield washer concentrate is spilled next to the filler neck.

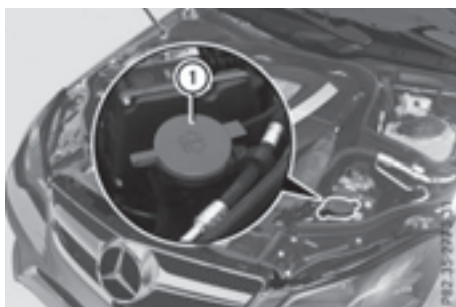

- ▶ **To open:** pull cap ① upwards by the tab.
- ▶ Add the premixed washer fluid.
- ▶ **To close:** press cap ① onto the filler neck until it engages.

If the washer fluid level drops below the recommended minimum of 1 liter, a message appears in the multifunction display prompting you to add washer fluid (▷ page 218).

Further information on windshield washer fluid/antifreeze (▷ page 312).

Maintenance

ASSYST PLUS

Service messages

The ASSYST PLUS service interval display informs you of the next service due date.

Information on the type of service and service intervals (see the separate Maintenance Booklet).

You can obtain further information from an authorized Mercedes-Benz Center or at <http://www.mbusa.com> (USA only).

- i** The ASSYST PLUS service interval display does not show any information on the engine oil level. Observe the notes on the engine oil level (▷ page 255).

The multifunction display shows a service message for several seconds, e.g.:

- Service A in .. days
- Service A Due
- Service A Exceeded by .. Days

Depending on the operating conditions of the vehicle, the remaining time or distance until the next service due date is displayed.

The letter **A** or **B**, possibly in connection with a number or another letter, indicates the type of service. **A** stands for a minor service and **B** for a major service.

You can obtain further information from an authorized Mercedes-Benz Center.

The ASSYST PLUS service interval display does not take into account any periods of time during which the battery is disconnected.

Maintaining the time-dependent service schedule:

- ▶ Note down the service due date displayed in the multifunction display before disconnecting the battery.





or

- ▶ After reconnecting the battery, subtract the battery disconnection periods from the service date shown on the display.

Hiding a service message

- ▶ Press the  or  button on the steering wheel.

Displaying service messages

- ▶ Switch on the ignition.
- ▶ Press the  or  button on the steering wheel to select the **Serv.** menu.
- ▶ Press the  or  button to select the **ASSYST PLUS** submenu and confirm by pressing the  button.
The service due date appears in the multifunction display.

Information about Service

Resetting the ASSYST PLUS service interval display

- i** If the ASSYST PLUS service interval display has been inadvertently reset, this setting can be corrected at a qualified specialist workshop.

Have service work carried out as described in the Maintenance Booklet. This may otherwise lead to increased wear and damage to the major assemblies or the vehicle.

A qualified specialist workshop, e.g. an authorized Mercedes-Benz Center, will reset the ASSYST PLUS service interval display after the service work has been carried out. You can also obtain further information on maintenance work, for example.

Special service requirements

The specified maintenance interval takes only the normal operation of the vehicle into account. Under arduous operating conditions or increased load on the vehicle, maintenance work must be carried out more frequently, for example:

- regular city driving with frequent intermediate stops
- if the vehicle is primarily used to travel short distances
- use in mountainous terrain or on poor road surfaces
- if the engine is often left idling for long periods

Under these or similar conditions, have, for example, the air filter, engine oil and oil filter replaced or changed more frequently. Under arduous operating conditions, the tires must be checked more often. Further information can be obtained at a qualified specialist workshop, e.g. an authorized Mercedes-Benz Center.

Driving abroad

An extensive Mercedes-Benz Service network is also available in other countries. You can obtain further information from any authorized Mercedes-Benz Center.

Care

General notes

Environmental note

Dispose of empty packaging and cleaning cloths in an environmentally responsible manner.

! For cleaning your vehicle, do not use any of the following:

- dry, rough or hard cloths
- abrasive cleaning agents
- solvents
- cleaning agents containing solvents

Do not scrub.

Do not touch the surfaces or protective films with hard objects, e.g. a ring or ice scraper. You could otherwise scratch or damage the surfaces and protective film.

! Do not park the vehicle for an extended period straight after cleaning it, particularly after having cleaned the wheels with wheel cleaner. Wheel cleaners could cause increased corrosion of the brake discs and brake pads/linings. For this reason, you should drive for a few minutes after cleaning. Braking heats the brake discs and the brake pads/linings, thus drying them. The vehicle can then be parked.

Regular care of your vehicle is a condition for retaining the quality in the long term.

Use care products and cleaning agents recommended and approved by Mercedes-Benz.

Washing the vehicle and cleaning the paintwork

Automatic car wash

WARNING

Braking efficiency is reduced after washing the vehicle. There is a risk of an accident.

After the vehicle has been washed, brake carefully while paying attention to the traffic conditions until full braking power is restored.

! If DISTRONIC PLUS or the HOLD function is activated, the vehicle brakes automatically in certain situations.

To prevent damage to the vehicle, deactivate DISTRONIC PLUS and the HOLD function in the following or other similar situations:

- when towing the vehicle
- in the car wash

! Preferably use automatic car washes with adjustable high-pressure pre-cleaning. This corresponds with the specification for the Cabriolet program. In car washes that use high water pressures, there is a risk that a small amount of water may leak into the vehicle.

! Never clean your vehicle in a Touchless Automatic Car Wash as these use special cleaning agents. These cleaning agents can damage the paintwork or plastic parts.

! Make sure that:

- the side windows and the sliding sunroof or soft top are fully closed.
- the ventilation/heating is switched off (the OFF button has been pressed).
- the windshield wiper switch is in position **0**. Otherwise, the vehicle might be damaged.

! In car washes with a towing mechanism, make sure that the automatic transmission is in transmission position **N**, otherwise the vehicle could be damaged.

- Vehicles with a SmartKey:

Do not remove the SmartKey from the ignition lock. Do not open the driver's door or front-passenger door when the engine is switched off. Otherwise, the automatic transmission selects park position **P** automatically and locks the wheels. You can prevent this by shifting the automatic transmission to **N** beforehand.

- Vehicles with KEYLESS-GO:

Do not open the driver's door or front-passenger door when the engine is switched off. Otherwise, the automatic transmission selects park position **P** automatically and locks the wheels.

Observe the following to make sure that the automatic transmission stays in position **N**:

- ▶ Make sure the vehicle is stationary and the ignition is switched off.
- ▶ Turn the SmartKey to position **2** in the ignition lock (▷ page 122).
Use the SmartKey instead of the Start/Stop button on vehicles with KEYLESS-GO.
- ▶ Depress and hold the brake pedal.
- ▶ Shift the automatic transmission to position **N**.
- ▶ Release the brake pedal.
- ▶ Release the parking brake.
- ▶ Switch off the ignition and leave the SmartKey in the ignition lock.

You can wash the vehicle in an automatic car wash from the very start.

If the vehicle is very dirty, pre-wash it before cleaning it in an automatic car wash.

After using an automatic car wash, wipe off wax from the windshield and the wiper blades. This will prevent smears and reduce wiping noises caused by residue on the windshield.

Washing by hand

In some countries, washing by hand is only allowed at specially equipped washing bays. Observe the legal requirements in each country.

- ▶ Do not use hot water and do not wash the vehicle in direct sunlight.
- ▶ Use a soft sponge to clean.
- ▶ Use a mild cleaning agent, such as a car shampoo approved by Mercedes-Benz.
- ▶ Thoroughly hose down the vehicle with a gentle jet of water.
- ▶ Do not point the water jet directly towards the air inlet.
- ▶ Use plenty of water and rinse out the sponge frequently.
- ▶ Rinse the vehicle with clean water and dry thoroughly with a chamois.
- ▶ Do not let the cleaning agent dry on the paintwork.

Carefully remove all deposits of road salt as soon as possible when driving in winter.

Power washers

WARNING

The water jet from a circular jet nozzle (dirt blasters) can cause invisible exterior damage

to the tires or chassis components. Components damaged in this way may fail unexpectedly. There is a risk of an accident.

Do not use power washers with circular jet nozzles to clean the vehicle. Have damaged tires or chassis components replaced immediately.

Cleaning the paintwork

 Do not affix:

- stickers
- films
- magnetic plates or similar items

to painted surfaces. You could otherwise damage the paintwork.

Scratches, corrosive deposits, areas affected by corrosion and damage caused by inadequate care cannot always be completely repaired. In such cases, visit a qualified specialist workshop.

- ▶ Remove dirt immediately, where possible, while avoiding rubbing too hard.
- ▶ Soak insect remains with insect remover and rinse off the treated areas afterwards.
- ▶ Soak bird droppings with water and rinse off the treated areas afterwards.
- ▶ Remove coolant, brake fluid, tree resin, oils, fuels and greases by rubbing gently with a cloth soaked in petroleum ether or lighter fluid.
- ▶ Use tar remover to remove tar stains.
- ▶ Use silicone remover to remove wax.

If water no longer forms "beads" on the paint surface, use the paint care products recommended and approved by Mercedes-Benz. This is the case approximately every three to five months, depending on the climate conditions and the care product used.

If dirt has penetrated the paint surface or if the paint has become dull, the paint cleaner recommended and approved by Mercedes-Benz should be used.

Do not use these care products in the sun or on the hood while the hood is hot.

- ▶ Use a suitable touch-up stick, e.g. MB Touch-Up Stick, to repair slight damage to the paintwork quickly and provisionally.

Matte finish care

! Never polish the vehicle or the light alloy wheels. Polishing causes the finish to shine.

! The following may cause the paint to become shiny and thus reduce the matte effect:

- strong rubbing of the paintwork with unsuitable materials
- frequent use of automatic car washes
- washing the vehicle in direct sunlight

! Never use paint cleaner, buffing or polishing products, or gloss preserver, e.g. wax. These products are only suitable for high-gloss surfaces. Their use on vehicles with matte finish leads to considerable surface damage (shiny, mottled areas).

Always have paintwork repairs carried out at a qualified specialist workshop.

! Do not use wash programs with a hot wax treatment under any circumstances.

Observe these notes if your vehicle has a clear matte finish. This will help you to avoid damage to the paintwork due to incorrect treatment.

These notes also apply to light alloy wheels with a clear matte finish.

- i** The vehicle should preferably be washed by hand using a soft sponge, car shampoo and plenty of water.
- i** Use only insect remover and car shampoo from the range of recommended and approved Mercedes-Benz care products.

Cleaning the vehicle parts

Cleaning the wheels

WARNING

The water jet from a circular jet nozzle (dirt blasters) can cause invisible exterior damage to the tires or chassis components. Components damaged in this way may fail unexpectedly. There is a risk of an accident.

Do not use power washers with circular jet nozzles to clean the vehicle. Have damaged tires or chassis components replaced immediately.

! Do not use acidic wheel cleaning products to remove brake dust. This could damage wheel bolts and brake components.

! Do not park the vehicle for an extended period straight after cleaning it, particularly after having cleaned the wheels with wheel cleaner. Wheel cleaners could cause increased corrosion of the brake discs and brake pads/linings. For this reason, you should drive for a few minutes after cleaning. Braking heats the brake discs and the brake pads/linings, thus drying them. The vehicle can then be parked.

Cleaning the windows

WARNING

You could become trapped by the windshield wipers if they start moving while cleaning the windshield or wiper blades. There is a risk of injury.

Always switch off the windshield wipers and the ignition before cleaning the windshield or wiper blades.

! Do not use dry cloths, abrasive products, solvents or cleaning agents containing solvents to clean the inside of the windows. Do not touch the insides of the windows with hard objects, e.g. an ice scraper or ring. There is otherwise a risk of damaging the windows.

! Clean the water drainage channels of the windshield and the rear window at regular intervals. Deposits such as leaves, petals and pollen may under certain circumstances prevent water from draining away. This can lead to corrosion damage and damage to electronic components.

► Clean the inside and outside of the windows with a damp cloth and a cleaning product that is recommended and approved by Mercedes-Benz.

Cleaning wiper blades

WARNING

You could become trapped by the windshield wipers if they start moving while cleaning the windshield or wiper blades. There is a risk of injury.

Always switch off the windshield wipers and the ignition before cleaning the windshield or wiper blades.

- ❗ Do not pull the wiper blade. Otherwise, the wiper blade could be damaged.
- ❗ Do not clean wiper blades too often and do not rub them too hard. Otherwise, the graphite coating could be damaged. This could cause wiper noise.
- ❗ Hold the wiper arm securely when folding back. The windshield could be damaged if the wiper arm smacks against it suddenly.
- ▶ Fold the windshield wiper arms away from the windshield.
- ▶ Carefully clean the wiper blades with a damp cloth.
- ▶ Fold the windshield wiper arms back again before switching on the ignition.

Cleaning the exterior lighting

- ❗ Only use cleaning agents or cleaning cloths which are suitable for plastic light lenses. Unsuitable cleaning agents or cleaning cloths could scratch or damage the plastic light lenses.
- ▶ Clean the plastic lenses of the exterior lighting using a wet sponge and a mild cleaning agent, e.g. Mercedes-Benz car shampoo or cleaning cloths.

Mirror turn signals

- ❗ Only use cleaning agents or cleaning cloths that are suitable for plastic lenses. Unsuitable cleaning agents or cleaning cloths could scratch or damage the plastic lenses of the mirror turn signals.
- ▶ Clean the plastic lenses of the mirror turn signals in the exterior mirror housing using a wet sponge and mild cleaning agent, e.g. Mercedes-Benz car shampoo or cleaning cloths.

Cleaning the sensors

- ❗ If you clean the sensors with a power washer, make sure that you keep a distance of at least 11.8 in (30 cm) between the vehicle and the power washer nozzle. Information

about the correct distance is available from the equipment manufacturer.

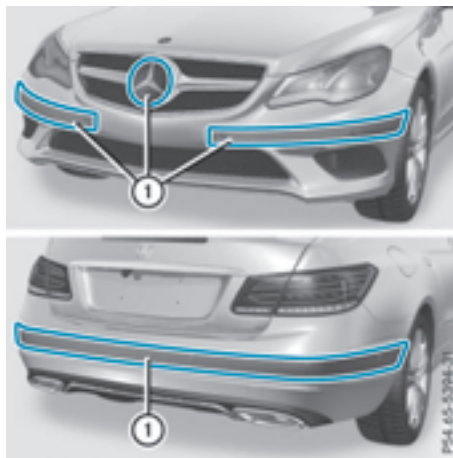

- ▶ Clean sensors ① of the driving systems with water, car shampoo and a soft cloth.

Cleaning the rear view camera

- ❗ Do not clean the camera lens and the area around the rear view camera with a power washer.



- ▶ Use clear water and a soft cloth to clean camera lens ①.

Cleaning the 360° camera

- ❗ Do not clean the camera lens and the area around the 360° camera with a power washer. 360



- ▶ Use clear water and a soft cloth to clean camera lens ①.

Cleaning the exhaust pipes

WARNING

The exhaust tail pipe and tail pipe trim can become very hot. If you come into contact with these parts of the vehicle, you could burn yourself. There is a risk of injury.

Always be particularly careful around the exhaust tail pipe and the tail pipe trim. Allow these components to cool down before touching them.

- ❗ Do not clean the exhaust pipe with acid-based cleaning agents, such as bathroom cleaner or wheel cleaner.

Impurities combined with the effects of road grit and corrosive environmental factors may cause flash rust to form on the surface. You can restore the original shine of the exhaust pipe by cleaning it regularly, especially in winter and after washing.

- ▶ Clean the exhaust pipe with a care product tested and approved by Mercedes-Benz.

Interior care

Cleaning the display

- ❗ For cleaning, do not use any of the following:
 - alcohol-based thinner or gasoline
 - abrasive cleaning agents
 - commercially-available household cleaning agents

These may damage the display surface. Do not put pressure on the display surface when cleaning. This could lead to irreparable damage to the display.

- ▶ Before cleaning the display, make sure that it is switched off and has cooled down.
- ▶ Clean the display surface using a commercially available microfiber cloth and TFT/LCD display cleaner.
- ▶ Dry the display surface using a dry microfiber cloth.

Cleaning the plastic trim

WARNING

Care products and cleaning agents containing solvents cause surfaces in the cockpit to become porous. As a result, plastic parts may come loose in the event of air bag deployment. There is a risk of injury.

Do not use any care products and cleaning agents to clean the cockpit.

- ❗ Do not affix the following to plastic surfaces:

- stickers
 - films
 - scented oil bottles or similar items
- You can otherwise damage the plastic.

- ❗ Do not allow cosmetics, insect repellent or sunscreen to come into contact with the plastic trim. This maintains the high-quality look of the surfaces.

- ▶ Wipe the plastic trim with a damp, lint-free cloth, e.g. a microfiber cloth.
- ▶ **Heavy soiling:** use care and cleaning products recommended and approved by Mercedes-Benz. The surface may change color temporarily. Wait until the surface is dry again.

Cleaning the steering wheel and gear or selector lever

- ▶ Thoroughly wipe with a damp cloth or use leather care agents that have been recommended and approved by Mercedes-Benz.

Cleaning genuine wood and trim elements

❗ Do not use solvent-based cleaning agents such as tar remover, wheel cleaners, polishes or waxes. There is otherwise a risk of damaging the surface.

❗ Do not use chrome polish on trim pieces. The trim pieces have a chrome look but are mostly made of anodized aluminum and can lose their shine if chrome polish is used. Use a damp, lint-free cloth instead when cleaning the trim pieces.

If the chrome-plated trim pieces are very dirty, you can use a chrome polish. If you are unsure as to whether the trim pieces are chrome-plated or not, consult an authorized Mercedes-Benz Center.

- ▶ Wipe the wooden trim and trim pieces with a damp, lint-free cloth, e.g. a microfiber cloth.
- ▶ **Heavy soiling:** use car care and cleaning products recommended and approved by Mercedes-Benz.

Cleaning the seat covers

General notes

❗ Do not use a microfiber cloth to clean covers made out of real leather, artificial leather or DINAMICA. If used often, these can damage the cover.

i Note that regular care is essential to ensure that the appearance and comfort of the covers is retained over time.

Genuine leather seat covers

Leather is a natural product.

It exhibits natural surface characteristics, for example:

- differences in the texture
- marks caused by growth and injury
- slight nuances of color

These are characteristics of leather and not material defects.

❗ To retain the natural appearance of the leather, observe the following cleaning instructions:

- Clean genuine leather covers carefully with a damp cloth and then wipe the covers down with a dry cloth.
- Make sure that the leather does not become soaked. It may otherwise become rough and cracked.
- Only use leather care agents that have been tested and approved by Mercedes-Benz. You can obtain these from a qualified specialist workshop.

Seat covers of other materials

❗ Observe the following when cleaning:

- clean artificial leather covers with a cloth moistened with a solution containing 1% detergent (e.g. dish washing liquid).
- clean cloth covers with a microfiber cloth moistened with a solution containing 1% detergent (e.g. dish washing liquid). Rub carefully and always wipe entire seat sections to avoid leaving visible lines. Leave the seat to dry afterwards. Cleaning results depend on the type of dirt and how long it has been there.
- clean DINAMICA covers with a damp cloth. Make sure that you wipe entire seat sections to avoid leaving visible lines.

Cleaning the seat belts

WARNING

Seat belts can become severely weakened if bleached or dyed. This could cause the seat belts to tear or fail, for instance, in the event of an accident. This poses an increased risk of injury or fatal injury.

Never bleach or dye the seat belts.

❗ Do not clean the seat belts using chemical cleaning agents. Do not dry the seat belts by heating at temperatures above 176 °F (80 °C) or in direct sunlight.

- ▶ Use clean, lukewarm water and soap solution.

Cleaning the headliner and carpets

- ▶ **Headliner:** if it is very dirty, use a soft brush or dry shampoo.
- ▶ **Carpets:** use the carpet and textile cleaning agents recommended and approved by Mercedes-Benz.

Where will I find...?

Vehicle tool kit

General notes

The vehicle tool kit can be found in the stowage well under the trunk floor (▷ page 239).

Vehicles with a "Minispare" emergency spare wheel



- ① "Minispare" emergency spare wheel
- ② Vehicle tool kit tray
- ③ Stowage well

- ▶ Open the trunk lid.
- ▶ Lift the trunk floor upwards (▷ page 239).

The vehicle tool kit contains:

- Straps for emergency release of the Cabriolet soft top
- Folding wheel chock
- Fuse allocation chart
- Jack
- Alignment bolt
- One pair of gloves
- Lug wrench
- Towing eye

i Example: equipment and country-specific variations possible.

Flat tire

Preparing the vehicle

Your vehicle may be equipped with:

- MOExtended tires (tires with run-flat properties) (▷ page 266)

Vehicle preparation is not necessary on vehicles with MOExtended tires

- a TIREFIT kit (▷ page 266)
- an emergency spare wheel (▷ page 304)

Vehicles equipped with MOExtended tires are not equipped with a TIREFIT kit at the factory. It is therefore recommended that you additionally equip your vehicle with a TIREFIT kit if you mount tires that do not feature run-flat properties, e.g. winter tires. A TIREFIT kit may be obtained from a qualified specialist workshop.

Information on changing and mounting wheels (▷ page 299).

- ▶ Stop the vehicle on solid, non-slippery and level ground, as far away as possible from traffic.
- ▶ Switch on the hazard warning lamps.
- ▶ Secure the vehicle against rolling away (▷ page 138).
- ▶ If possible, bring the front wheels into the straight-ahead position.
- ▶ Switch off the engine.
- ▶ Remove the SmartKey from the ignition lock. or, on vehicles with KEYLESS-GO:
 - ▶ Open the driver's door. The on-board electronics now have status **0**. This is the same as the SmartKey having been removed.
- ▶ Remove the Start/Stop button from the ignition lock (▷ page 122).
- ▶ Make sure that the passengers are not endangered as they do so. Make sure that no one is near the danger area while a wheel is being changed. Anyone who is not directly assisting in the wheel change should, for example, stand behind the barrier.
- ▶ Get out of the vehicle. Pay attention to traffic conditions when doing so.
- ▶ Close the driver's door.

MOExtended tires (tires with run-flat properties)

General notes

With MOExtended tires (tires with run flat characteristics), you can continue to drive your vehicle even if there is a total loss of pressure in one or more tires. The affected tire must not show any clearly visible damage.

You can recognize MOExtended tires by the MOExtended marking which appears on the sidewall of the tire. You will find this marking next to the tire size designation, the load-bearing capacity and the speed index (▷ page 294). MOExtended tires may only be used in conjunction with an active tire pressure monitor.

If a pressure loss warning message appears in the multifunction display:

- observe the instructions in the display messages (▷ page 214).
- check the tire for damage.
- if driving on, observe the following notes.

The driving distance possible in run-flat mode is approximately 50 miles (80 km) when the vehicle is partially laden. When the vehicle is fully laden it is approximately 19 miles (30 km).

In addition to the vehicle load, the driving distance possible depends upon:

- vehicle speed
- road condition
- outside temperature

The driving distance possible in run-flat mode may be reduced by extreme driving conditions or maneuvers, or it can be increased through a moderate style of driving.

The driving distance possible in run-flat mode is counted from the moment the tire pressure loss warning appears in the multifunction display.

You must not exceed a maximum speed of 50 mph (80 km/h).

When replacing one or all tires, please observe the following specifications for your vehicle's tires:

- size
- the type and
- the "MOExtended" mark

If a tire has gone flat and cannot be replaced with a MOExtended tire, a standard tire may be used as a temporary measure. Make sure that you use the proper size and type (summer or winter tire).

Vehicles equipped with MOExtended tires are not equipped with a TIREFIT kit at the factory. It is therefore recommended that you additionally equip your vehicle with a TIREFIT kit if you mount tires that do not feature run-flat properties, e.g. winter tires. A TIREFIT kit may be obtained from a qualified specialist workshop.

Important safety notes

WARNING

When driving in emergency mode, the driving characteristics deteriorate, e.g. when cornering, accelerating quickly and when braking. There is a risk of an accident.

Do not exceed the stated maximum speed. Avoid abrupt steering and driving maneuvers, and driving over obstacles (curbs, potholes, off-road). This applies in particular to a laden vehicle.

Stop driving in emergency mode if:

- you hear banging noises.
- the vehicle starts to shake.
- you see smoke and smell rubber.
- ESP® is intervening constantly.
- there are tears in the sidewalls of the tire.

After driving in emergency mode, have the wheel rims checked at a qualified specialist workshop with regard to their further use. The defective tire must be replaced in every case.

TIREFIT kit

Important safety notes

TIREFIT is a tire sealant.

You can use TIREFIT to seal punctures of up to 0.16 in (4 mm), particularly those in the tire tread. You can use TIREFIT at outside temperatures down to -4 °F (-20 °C).

WARNING

In the following situations, the tire sealant is unable to provide sufficient breakdown assistance, as it is unable to seal the tire properly:

- there are cuts or punctures in the tire larger than those mentioned above.
- the wheel rim is damaged.
- you have driven at very low tire pressures or on a flat tire.

There is a risk of an accident.

Do not drive the vehicle. Contact a qualified specialist workshop.

WARNING

The tire sealant is harmful and causes irritation. It must not come into contact with your skin, eyes or clothing or be swallowed. Do not inhale TIREFIT fumes. Keep tire sealant away from children. There is a risk of injury.

If you come into contact with the tire sealant, observe the following:

- Rinse off the tire sealant from your skin immediately with water.
- If the tire sealant comes into contact with your eyes, immediately rinse them thoroughly with clean water.
- If tire sealant is swallowed, immediately rinse your mouth out thoroughly and drink plenty of water. Do not induce vomiting, and seek medical attention immediately.
- Immediately change out of clothing which has come into contact with tire sealant.
- If an allergic reaction occurs, seek medical attention immediately.

! Do not operate the tire inflation compressor for longer than eight minutes at a time without a break. It may otherwise overheat.

The tire inflation compressor can be operated again once it has cooled down.

Comply with the manufacturer's safety instructions on the sticker on the tire inflation compressor.

Using the TIREFIT kit

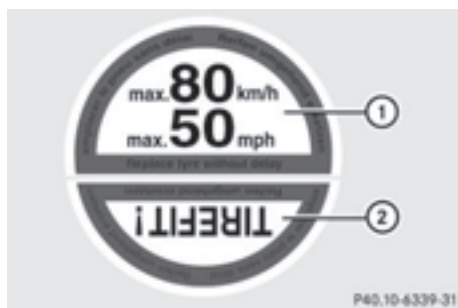

- ▶ Do not remove any foreign objects which have penetrated the tire, e.g. screws or nails.
- ▶ Remove the tire sealant bottle, the accompanying TIREFIT sticker and the tire inflation

compressor from the stowage well underneath the trunk floor (▷ page 266).

- ▶ Affix part ① of the TIREFIT sticker to the instrument cluster within the driver's field of vision.
- ▶ Affix part ② of the TIREFIT sticker near the valve on the wheel with the defective tire.

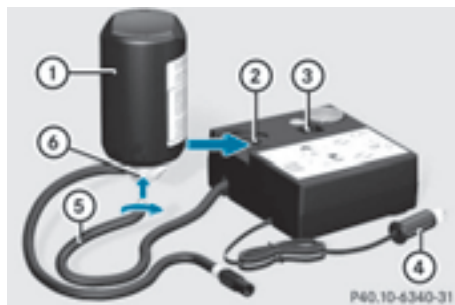

- ▶ Pull connector ④ with the cable and hose ⑤ out of the tire inflation compressor housing.
- ▶ Screw hose ⑤ onto flange ⑥ of tire sealant bottle ①.
- ▶ Place tire sealant bottle ① head downwards into recess ② of the tire inflation compressor.

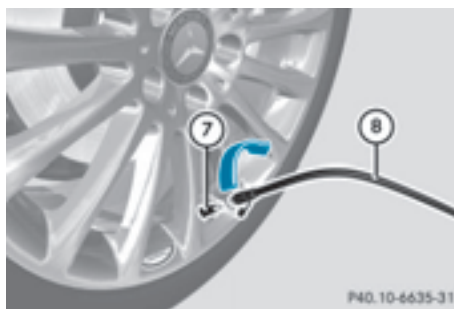

- ▶ Remove the cap from valve ⑦ on the faulty tire.
- ▶ Screw filler hose ⑧ onto valve ⑦.
- ▶ Insert connector ④ into a 12 V socket (▷ page 243) in your vehicle.
- ▶ Turn the SmartKey to position 1 in the ignition lock (▷ page 122).
- ▶ Press on and off switch ③ on the tire inflation compressor to I. The tire inflation compressor is switched on. The tire is inflated.

First, tire sealant is pumped into the tire. The pressure can briefly rise to approximately 500 kPa (5 bar/73 psi).

Do not switch off the tire inflation compressor during this phase.

- ▶ Let the tire inflation compressor run for a maximum of five minutes. The tire should then have attained a pressure of at least 180 kPa (1.8 bar/26 psi).

If a pressure of 180 kPa (1.8 bar/26 psi) has been attained after five minutes, see "Tire pressure reached" (▷ page 269).

If a tire pressure of 180 kPa (1.8 bar/26 psi) has not been attained after five minutes, see "Tire pressure not reached" (▷ page 269).

If tire sealant has escaped, clean it off affected areas as quickly as possible. Use plain water if possible.

If your clothes are soiled with tire sealant, have them cleaned with perchloroethylene at a dry cleaner as soon as possible.

Tire pressure not reached

If a pressure of 180 kPa (1.8 bar/26 psi) has not been attained after five minutes:

- ▶ Switch off the tire inflation compressor.
- ▶ Unscrew the filler hose from the valve of the faulty tire.

Note that tire sealant may escape when you unscrew the filler hose.

- ▶ Very slowly drive forwards or reverse approximately 30 ft (10 m).
- ▶ Pump up the tire again.

After a maximum of five minutes the tire pressure must be at least 180 kPa (1.8 bar/26 psi).

WARNING

If the required tire pressure is not reached after the specified time, the tire is too badly damaged. The tire sealant cannot repair the tire in this instance. Damaged tires and a tire pressure that is too low can significantly impair the vehicle's braking and driving characteristics. There is a risk of accident.

Do not continue driving. Contact a qualified specialist workshop.

Tire pressure reached

WARNING

A tire temporarily sealed with tire sealant impairs the driving characteristics and is not suitable for higher speeds. There is a risk of accident.

You should therefore adapt your driving style accordingly and drive carefully. Do not exceed the specified maximum speed with a tire that has been repaired using tire sealant.

The maximum speed for a tire sealed with tire sealant is 50 mph (80 km/h). The upper part of the TIREFIT sticker must be affixed to the instrument cluster in the driver's field of vision.

- ! After use, excess tire sealant may run out of the filler hose. This could cause stains.

Therefore, place the tire sealant bottle with filler hose in the plastic bag which is contained in the TIREFIT kit.

Environmental note

Have the used tire sealant bottle disposed of professionally, e.g. at a qualified specialist workshop.

If a tire pressure of 180 kPa (1.8 bar/26 psi) has been attained after five minutes:

- ▶ Switch off the tire inflation compressor.
- ▶ Unscrew the filler hose from the valve of the faulty tire.
- ▶ Stow the tire sealant bottle and the tire inflation compressor.
- ▶ **Pull away immediately.**
- ▶ Stop after driving for approximately ten minutes and check the tire pressure with the tire inflation compressor.
The tire pressure must now be at least 130 kPa (1.3 bar/19 psi).

WARNING

If the required tire pressure is not reached after driving for a short period, the tire is too badly damaged. The tire sealant cannot repair the tire in this instance. Damaged tires and a tire pressure that is too low can significantly impair the vehicle's braking and driving characteristics. There is a risk of accident.

Do not continue driving. Contact a qualified specialist workshop.

i In cases such as the one mentioned above, contact an authorized Mercedes-Benz Center. Or call 1-800-FOR-MERCEDES (in the USA) or 1-800-387-0100 (in Canada).

- ▶ Correct the tire pressure if it is still at least 130 kPa (1.3 bar/19 psi). See the Tire and Loading Information placard on the driver's side B-pillar or the tire pressure table in the fuel filler flap for values.
- ▶ **To increase the tire pressure:** switch on the tire inflation compressor.

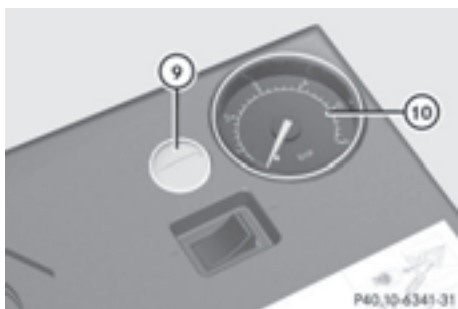

- ▶ **To reduce the tire pressure:** depress pressure release button ⑨ next to pressure gauge ⑩.
- ▶ When the tire pressure is correct, unscrew the filler hose from the valve of the sealed tire.
- ▶ Screw the valve cap onto the tire valve of the sealed tire.
- ▶ Pull the tire sealant bottle out of the tire inflation compressor.
The filler hose remains attached to the tire sealant bottle.
- ▶ Drive to the nearest qualified specialist workshop and have the tire changed there.
- ▶ Have the tire sealant bottle and the filler hose replaced as soon as possible at a qualified specialist workshop.
- ▶ Have the tire sealant bottle replaced every four years at a qualified specialist workshop.

Battery (vehicle)

Important safety notes

Special tools and expert knowledge are required when working on the battery, e.g. removal and installation. You should therefore have all work involving the battery carried out at a qualified specialist workshop.

WARNING

Work carried out incorrectly on the battery can lead, for example, to a short circuit and thus damage the vehicle electronics. This can lead to function restrictions applying to safety-relevant systems, e.g. the lighting system, the ABS (anti-lock braking system) or the ESP® (Electronic Stability Program). The operating safety of your vehicle may be restricted. You could lose control of the vehicle, for example:

- when braking
- in the event of abrupt steering maneuvers and/or when the vehicle's speed is not adapted to the road conditions

There is a risk of an accident.

In the event of a short circuit or a similar incident, contact a qualified specialist workshop immediately. Do not drive any further. You should have all work involving the battery carried out at a qualified specialist workshop.

For further information about ABS (> page 62) and ESP® (> page 67).

WARNING

Electrostatic build-up can lead to the creation of sparks, which could ignite the highly explosive gases of a battery. There is a risk of an explosion.

Before handling the battery, touch the vehicle body to remove any existing electrostatic build-up.

The highly flammable gas mixture forms when charging the battery as well as when jump-starting.

Always make sure that neither you nor the battery is electrostatically charged. A build-up of electrostatic charge can be caused, for example:

- by wearing clothing made from synthetic fibers
- due to friction between clothing and seats
- if you push or pull the battery across the carpet or other synthetic materials
- if you wipe the battery with a cloth

WARNING

During the charging process, a battery produces hydrogen gas. If a short circuit occurs or sparks are created, the hydrogen gas can ignite. There is a risk of an explosion.

- Make sure that the positive terminal of a connected battery does not come into contact with vehicle parts.
- Never place metal objects or tools on a battery.
- It is important that you observe the described order of the battery terminals when connecting and disconnecting a battery.
- When jump-starting, make sure that the battery poles with identical polarity are connected.
- It is particularly important to observe the described order when connecting and disconnecting the jumper cables.
- Never connect or disconnect the battery terminals while the engine is running.

WARNING

Battery acid is caustic. There is a risk of injury. Avoid contact with skin, eyes or clothing. Do not inhale any battery gases. Do not lean over the battery. Keep children away from batteries. Wash away battery acid immediately with plenty of clean water and seek medical attention.

Environmental note



Batteries contain dangerous substances. It is against the law to dispose of them with the household rubbish. They

must be collected separately and recycled to protect the environment.



Dispose of batteries in an environmentally friendly manner. Take discharged batteries to a qualified specialist workshop or a special collection point for used batteries.

- ❗ Have the battery checked regularly at a qualified specialist workshop.

Observe the service intervals in the Maintenance Booklet or contact a qualified specialist workshop for more information.

- ❗ Always have work on batteries carried out at a qualified specialist workshop. Should it, in exceptional circumstances, be absolutely necessary to disconnect the 12-volt battery yourself, observe the following:

- secure the vehicle to prevent it from rolling away.
- switch off the ignition.
- always disconnect the negative terminal clamp first, followed by the positive terminal clamp.

After the battery has been disconnected, the transmission is locked in position **P**.

After the work has been done, install the battery and replace the cover of the positive terminal clamp firmly.

Comply with safety precautions and take protective measures when handling batteries.



Risk of explosion.



Fire, open flames and smoking are prohibited when handling the battery. Avoid creating sparks.



Battery acid is caustic. Avoid contact with skin, eyes or clothing.

Wear suitable protective clothing, especially gloves, apron and face-guard.

Rinse any acid spills immediately with clear water. Contact a physician if necessary.



Wear eye protection.



Keep children away.



Observe this Operator's Manual.

For safety reasons, Mercedes-Benz recommends that you only use batteries which have been tested and approved for your vehicle by Mercedes-Benz. These batteries provide increased impact protection to prevent vehicle occupants from suffering acid burns should the battery be damaged in the event of an accident.

In order for the battery to achieve the maximum possible service life, it must always be sufficiently charged.

Like other batteries, the vehicle battery may discharge over time if you do not use the vehicle. In this case, have the battery disconnected at a qualified specialist workshop. You can also charge the battery with a charger recommended by Mercedes-Benz. Contact a qualified specialist workshop for further information.

Have the battery condition of charge checked more frequently if you use the vehicle mainly for short trips or if you leave it standing idle for a lengthy period. Consult a qualified specialist workshop if you wish to leave your vehicle parked for a long period of time.

Remove the SmartKey if you park the vehicle and do not require any electrical consumers. The vehicle will then use very little energy, thus conserving battery power.

If the power supply has been interrupted, e.g. if you reconnect the battery, you will have to:

- set the clock. Information on setting the clock can be found in the Digital Operator's Manual. On vehicles with a multimedia system, the time is set automatically.
- reset the function for folding the exterior mirrors in/out automatically, by folding the mirrors out once (▷ page 100)

Charging the battery

WARNING

During charging and jump-starting, explosive gases can escape from the battery. There is a risk of an explosion.

Particularly avoid fire, open flames, creating sparks and smoking. Ensure there is sufficient ventilation while charging and jump-starting. Do not lean over a battery.

WARNING

Battery acid is caustic. There is a risk of injury. Avoid contact with skin, eyes or clothing. Do not inhale any battery gases. Do not lean over the battery. Keep children away from batteries. Wash away battery acid immediately with plenty of clean water and seek medical attention.

WARNING

A discharged battery can freeze at temperatures below freezing point. When jump-starting the vehicle or charging the battery, gases can escape from the battery. There is a risk of an explosion.

Allow the frozen battery to thaw out before charging it or jump-starting.

Only use battery chargers with a maximum charging voltage of 14.8 V.

Only charge the battery using the jump-starting connection point.

The jump-starting connection point is in the engine compartment (▷ page 274).

► Open the hood.

► Connect the battery charger to the positive terminal and ground point in the same order as when connecting the donor battery in the jump-starting procedure (▷ page 274).

If the indicator/warning lamps do not light up at low temperatures, it is very likely that the discharged battery has frozen. In this case, you may neither charge the battery nor jump-start the vehicle. The service life of a thawed-out battery may be shorter. The starting characteristics may be impaired, especially at low tempera-

tures. Have the thawed-out battery checked at a qualified specialist workshop.

Never charge a battery still installed in the vehicle unless a battery charger unit approved by Mercedes-Benz is being used. A battery charger unit specially adapted for Mercedes-Benz vehicles and tested and approved by Mercedes-Benz is available as an accessory. It permits the charging of the battery in its installed position. Contact an authorized Mercedes-Benz Center for further information and availability. Read the battery charger's operating instructions before charging the battery.

Jump-starting

For the jump-starting procedure, use only the jump-starting connection point in the engine compartment, consisting of a positive terminal and a ground point.

WARNING

Battery acid is caustic. There is a risk of injury.

Avoid contact with skin, eyes or clothing. Do not inhale any battery gases. Do not lean over the battery. Keep children away from batteries. Wash away battery acid immediately with plenty of clean water and seek medical attention.

WARNING

During charging and jump-starting, explosive gases can escape from the battery. There is a risk of an explosion.

Particularly avoid fire, open flames, creating sparks and smoking. Ensure there is sufficient ventilation while charging and jump-starting. Do not lean over a battery.

WARNING

During the charging process, a battery produces hydrogen gas. If a short circuit occurs or sparks are created, the hydrogen gas can ignite. There is a risk of an explosion.

- Make sure that the positive terminal of a connected battery does not come into contact with vehicle parts.
- Never place metal objects or tools on a battery.
- It is important that you observe the described order of the battery terminals when connecting and disconnecting a battery.
- When jump-starting, make sure that the battery poles with identical polarity are connected.
- It is particularly important to observe the described order when connecting and disconnecting the jumper cables.
- Never connect or disconnect the battery terminals while the engine is running.

WARNING

A discharged battery can freeze at temperatures below freezing point. When jump-starting the vehicle or charging the battery, gases can escape from the battery. There is a risk of an explosion.

Allow the frozen battery to thaw out before charging it or jump-starting.

- ❗ Avoid repeated and lengthy starting attempts. Otherwise, the catalytic converter could be damaged by the non-combusted fuel.

If, at low temperatures, the indicator lamps/warning lamps in the instrument cluster do not light up, it is highly likely that the discharged battery has frozen. In this case, you may neither charge the battery nor jump-start the vehicle. The service life of a thawed-out battery may be shorter. The starting characteristics can be impaired, particularly at low temperatures. Have the thawed-out battery checked at a qualified specialist workshop.

Do not start the vehicle using a rapid charging device. If your vehicle's battery is discharged, the engine can be jump-started from another vehicle or from a second battery using jumper cables. Observe the following points:

- The battery is not accessible in all vehicles. If the other vehicle's battery is not accessible, jump-start the vehicle using a second battery or a jump-starting device.
- You may only jump-start the vehicle when the engine and exhaust system are cold.
- Only jump-start from batteries with a 12 V voltage rating.
- Only use jumper cables which have a sufficient cross-section and insulated terminal clamps.
- If the battery is fully discharged, leave the battery that is being used to jump-start connected for a few minutes before attempting to start. This charges the battery slightly.
- Make sure that the two vehicles do not touch.

Make sure that:

- the jumper cables are not damaged.
 - when the jumper cables are connected to the battery, uninsulated sections of the terminal clamp do not come into contact with other metal sections.
 - the jumper cables cannot come into contact with parts which can move when the engine is running, such as the V-belt pulley or the fan.
- ▶ Apply the parking brake firmly.
- ▶ Shift the transmission to position **P**.
- ▶ Make sure that the ignition is switched off. All indicator lamps in the instrument cluster must be off. When using the SmartKey, turn the SmartKey to position **0** in the ignition lock and remove it (> page 122).
- ▶ Switch off all electrical consumers, e.g. rear window defroster, lighting, etc.
- ▶ Open the hood.

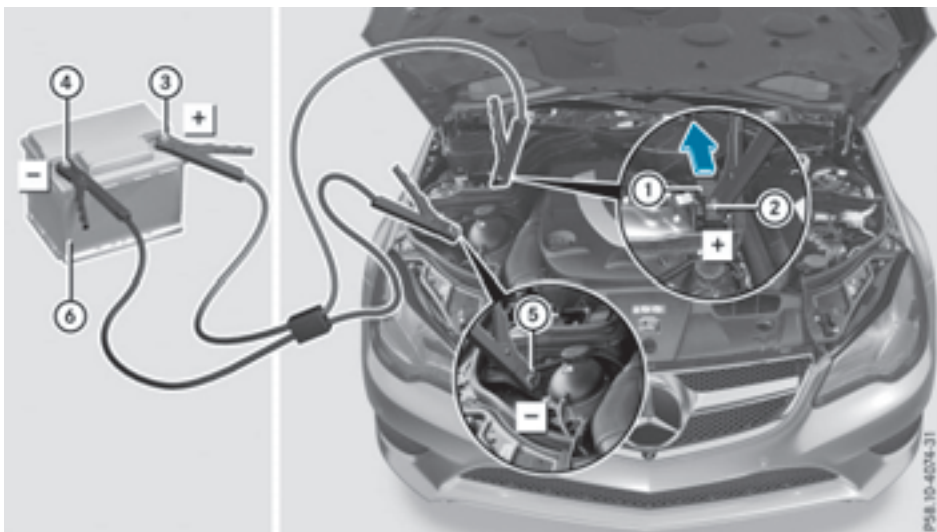

Position number ⑥ identifies the charged battery of the other vehicle or an equivalent jump-starting device.

- ▶ Slide cover ① of positive terminal ② in the direction of the arrow.
- ▶ Connect positive terminal ② on your vehicle to positive terminal ③ of donor battery ⑥ using the jumper cable, always begin with positive terminal ② on your own vehicle first.

- ▶ Start the engine of the donor vehicle and run it at idling speed.
- ▶ Connect negative terminal ④ of donor battery ⑥ to ground point ⑤ of your vehicle using the jumper cable, connecting the jumper cable to battery of other vehicle ⑥ first.
- ▶ Start the engine.
- ▶ Before disconnecting the jumper cables, let the engine run for several minutes.
- ▶ First, remove the jumper cables from ground point ⑤ and negative terminal ④, then from positive clamp ② and positive terminal ③. Begin each time at the contacts on your own vehicle first.
- ▶ Close cover ① of positive clamp ② after removing the jumper cables.
- ▶ Have the battery checked at a qualified specialist workshop.

Jump-starting is not considered to be a normal operating condition.

- ❗ Jumper cables and further information regarding jump-starting can be obtained at any qualified specialist workshop.

Towing and tow-starting

Important safety notes

WARNING

Functions relevant to safety are restricted or no longer available if:

- the engine is not running.
- the brake system or the power steering is malfunctioning.
- there is a malfunction in the voltage supply or the vehicle's electrical system.

If your vehicle is being towed, much more force may be necessary to steer or brake. There is a risk of an accident.

In such cases, use a tow bar. Before towing, make sure that the steering moves freely.

WARNING

When towing or tow-starting another vehicle and its weight is greater than the permissible gross weight of your vehicle, the:

- the towing eye could detach itself
- the vehicle/trailer combination could roll-over.

There is a risk of an accident.

When towing or tow-starting another vehicle, its weight should not be greater than the permissible gross weight of your vehicle.

Details on the permissible gross vehicle weight of your vehicle can be found on the vehicle identification plate (▷ page 307).

- ❗ When COLLISION PREVENTION ASSIST PLUS, DISTRONIC PLUS or the HOLD function is activated, the vehicle brakes automatically in certain situations.

To avoid damage to the vehicle, deactivate these systems in the following or similar situations:

- when towing the vehicle
- in the car wash

- ❗ Only secure the tow rope or tow bar at the towing eyes. Otherwise, the vehicle could be damaged.

- ❗ Do not use the towing eye for recovery, this could damage the vehicle. If in doubt, recover the vehicle with a crane.

- ❗ When towing, pull away slowly and smoothly. If the tractive power is too high, the vehicles could be damaged.

- ❗ Do not tow with sling-type equipment. This could damage the vehicle.

- ❗ On vehicles with KEYLESS-GO, use the SmartKey instead of the Start/Stop button. Turn the SmartKey to position **2** in the ignition lock and shift the automatic transmission to **N**. Then, turn the SmartKey back to **0** and leave it in the ignition lock.

- ❗ The vehicle can be towed a maximum of 30 miles (50km). The towing speed of 30 mph (50 km/h) must not be exceeded.

If the vehicle has to be towed more than 30 miles (50km), the entire vehicle must be raised and transported.

! If you tow or tow-start another vehicle, its weight must not exceed the maximum permissible gross vehicle weight of your vehicle.

It is better to have the vehicle transported than to have it towed away.

If the vehicle has suffered transmission damage, have it transported on a transporter or trailer.

The automatic transmission must be in position **N** when the vehicle is being towed.

The battery must be connected and charged. Otherwise, you:

- cannot turn the SmartKey to position **2** in the ignition lock
- cannot shift the automatic transmission to position **N**

In the event of damage to the electrical system

If the battery is defective, the automatic transmission will be locked in position **P**. To shift the automatic transmission to position **N**, you must provide power to the vehicle's electrical system in the same way as when jump-starting (▷ page 274).

Have the vehicle transported on a transporter or trailer.

Disarm the automatic locking feature before the vehicle is towed (▷ page 79). You could otherwise be locked out when pushing or towing the vehicle.

Installing/removing the towing eye

Installing the towing eye

WARNING

The exhaust tail pipe may be very hot. There is a risk of burns when removing the rear cover.

Do not touch the exhaust pipe. Take particular care when removing the rear cover.

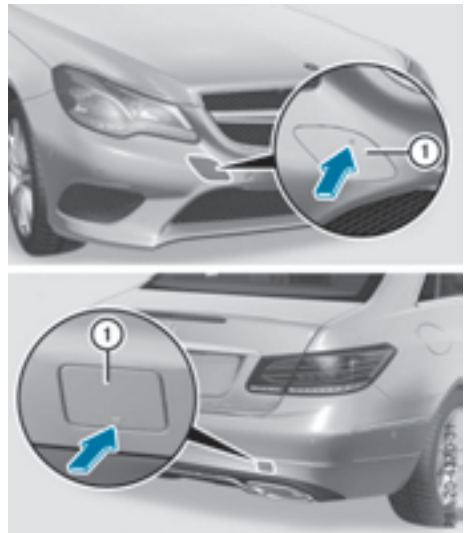

The mountings for the removable towing eyes are located in the bumpers. They are at the rear and at the front, under covers ①.

- ▶ Remove the towing eye from the vehicle tool kit (▷ page 266).
- ▶ Press the mark on cover ① inwards in the direction of the arrow.
- ▶ Take cover ① off the opening.
- ▶ Screw in the towing eye clockwise as far as it will go and tighten it.

Removing the towing eye

- ▶ Unscrew and remove the towing eye.
- ▶ Position cover ① on top of the bumper and press it in at the bottom until it engages.
- ▶ Place the towing eye in the vehicle tool kit.

Towing a vehicle with both axles on the ground

It is important that you observe the safety instructions when towing away your vehicle (▷ page 276).

- ▶ Turn the SmartKey to position **2** in the ignition lock.
- ▶ When the vehicle is stationary, depress the brake pedal and keep it depressed.
- ▶ Shift the automatic transmission to position **N**.

- ▶ Release the brake pedal.
- ▶ Release the parking brake.

In order to signal a change of direction when towing the vehicle with the hazard warning lamps switched on, use the combination switch as usual. In this case, only the indicator lamps for the direction of travel flash. After resetting the combination switch, the hazard warning lamp starts flashing again.

Towing the vehicle with the rear axle raised

! Vehicles with 4MATIC must not be towed with either the front or the rear axle raised, as doing so will damage the transmission.

! Vehicles with automatic transmission must not be towed with the rear axle raised. The vehicle/trailer combination may otherwise swerve or even roll over.

Transporting the vehicle

4MATIC vehicles/vehicles with automatic transmission

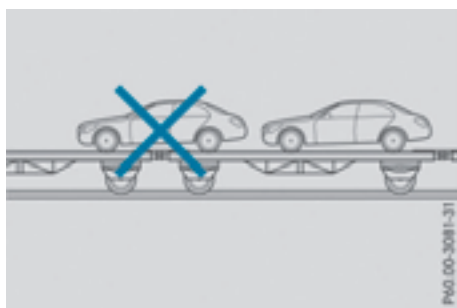

! When the vehicle is loaded for transport, the front and rear axles must be stationary and on the same transportation vehicle. Positioning over the connection point of the transport vehicle is not permitted. The drive train may otherwise be damaged.

All vehicles

! You may only secure the vehicle by the wheels, not by parts of the vehicle such as axle or steering components. Otherwise, the vehicle could be damaged.

The towing eye can be used to pull the vehicle onto a trailer or transporter for transporting purposes.

- ▶ Turn the SmartKey to position **2** in the ignition lock.
- ▶ Shift the automatic transmission to position **N**.

As soon as the vehicle has been loaded:

- ▶ Prevent the vehicle from rolling away by applying the parking brake.
- ▶ Shift the automatic transmission to position **P**.
- ▶ Turn the SmartKey to position **0** in the ignition lock and remove it.
- ▶ Secure the vehicle.

Notes on 4MATIC vehicles

! Vehicles with 4MATIC must not be towed with either the front or the rear axle raised, as doing so will damage the transmission.

If the vehicle has transmission damage or damage to the front or rear axle, have it transported on a transporter or trailer.

In the event of damage to the electrical system

If the battery is defective, the automatic transmission will be locked in position **P**. To shift the automatic transmission to position **N**, you must provide power to the vehicle's electrical system in the same way as when jump-starting (> page 274).

Have the vehicle transported on a transporter or trailer.

Tow-starting (emergency engine starting)

! Vehicles with automatic transmission must not be started by tow-starting. This could otherwise damage the transmission.

i You can find information on "Jump-starting" under (> page 274).

Fuses

Important safety notes

WARNING

If you manipulate or bridge a faulty fuse or if you replace it with a fuse with a higher amperage, the electric cables could be overloaded. This could result in a fire. There is a risk of an accident and injury.

Always replace faulty fuses with the specified new fuses having the correct amperage.

Blown fuses must be replaced with fuses of the same rating, which you can recognize by the color and value. The fuse ratings are listed in the fuse allocation chart.

The fuse allocation chart is located in the vehicle tool kit in the stowage compartment under the trunk floor (▷ page 266).

If a newly inserted fuse also blows, have the cause traced and rectified at a qualified specialist workshop, e.g. an authorized Mercedes-Benz Center.

! Only use fuses that have been approved for Mercedes-Benz vehicles and which have the correct fuse rating for the system concerned. Otherwise, components or systems could be damaged.

! Make sure that no moisture can enter the fuse box when the cover is open.

! When closing the cover, make sure that it is lying correctly on the fuse box. Moisture seeping in or dirt could otherwise impair the operation of the fuses.

The fuses in your vehicle serve to close down faulty circuits. If a fuse blows, all the components on the circuit and their functions stop operating.

Before changing a fuse

Pay attention to the important safety notes (▷ page 279).

- ▶ Switch off the engine.
- ▶ Switch off all electrical consumers.
- ▶ Secure the vehicle against rolling away (▷ page 138).

▶ Remove the SmartKey from the ignition lock. or, on vehicles with KEYLESS-GO:

▶ Open the driver's door.

The on-board electronics now have status **O**. This is the same as the SmartKey having been removed.

▶ Remove the Start/Stop button from the ignition lock (▷ page 122).

All indicator lamps in the instrument cluster must be off.

The fuses are located in various fuse boxes:

- Fuse box on the driver's side of the dashboard
- Fuse box in the engine compartment on the left-hand side of the vehicle, when viewed in the direction of travel
- Fuse box in the trunk on the right-hand side of the vehicle, when viewed in the direction of travel

Dashboard fuse box

Pay attention to the important safety notes (▷ page 279).

! Do not use a pointed object such as a screwdriver to open the cover in the dashboard. You could damage the dashboard or the cover.

! Make sure that no moisture can enter the fuse box when the cover is open.

! When closing the cover, make sure that it is lying correctly on the fuse box. Moisture seeping in or dirt could otherwise impair the operation of the fuses.



▶ **To open:** pull out cover ① slightly at the bottom in the direction of arrow ③.

▶ Pull cover ① outwards in the direction of arrow ② and remove it.

- ▶ **To close:** clip in cover ① on the front of the dashboard.
- ▶ Fold cover ① inwards until it engages.

Fuse box in the engine compartment

Pay attention to the important safety notes (▷ page 279).

WARNING

When the hood is open and the windshield wipers are set in motion, you can be injured by the wiper linkage. There is a risk of injury.

Always switch off the windshield wipers and the ignition before opening the hood.



- ▶ Make sure that the windshield wipers are turned off.
- ▶ Open the hood (▷ page 254).
- ▶ Use a dry cloth to remove any moisture from the fuse box.
- ▶ **To open:** remove lines ② from the guides.
- ▶ Move lines ② aside. Route the lines behind connection ③ to do this.
- ▶ Open clamp ①.
- ▶ Remove the fuse box cover forwards.
- ▶ **To close:** check whether the seal is lying correctly in the cover.
- ▶ Insert the cover at the rear of the fuse box into the retainer.
- ▶ Fold down cover and close clamps ①.
- ▶ Secure lines ② in the guides.
- ▶ Close the hood.

Fuse box in the trunk

Pay attention to the important safety notes (▷ page 279).

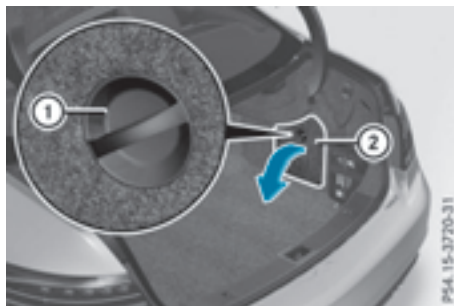

- ▶ Open the trunk lid.
- ▶ **To open:** turn rotary catch ① on cover ② to the right.
- ▶ Swing cover ② down.

Important safety notes

WARNING

If wheels and tires of the wrong size are used, the wheel brakes or suspension components may be damaged. There is a risk of an accident.

Always replace wheels and tires with those that fulfill the specifications of the original part.

When replacing wheels, make sure to use the correct:

- designation
- model

When replacing tires, make sure to use the correct:

- designation
- manufacturer
- model

WARNING

A flat tire severely impairs the driving, steering and braking characteristics of the vehicle. There is a risk of accident.

Tires without run-flat characteristics:

- do not drive with a flat tire.
- immediately replace the flat tire with your emergency spare wheel or spare wheel, or consult a qualified specialist workshop.

Tires with run-flat characteristics:

- pay attention to the information and warning notices on MOExtended tires (tires with run-flat characteristics).

Accessories that are not approved for your vehicle by Mercedes-Benz or are not being used correctly can impair the operating safety.

Before purchasing and using non-approved accessories, visit a qualified specialist workshop and ask about:

- suitability
- legal stipulations
- factory recommendations

Further information regarding wheels and tires can be found under "Wheel/tire combinations" (> page 303).

You can ask for information regarding permitted wheel-tire combinations at an authorized Mercedes-Benz Center.

Information on tire pressure can be found:

- on the Tire and Loading Information placard on the B-pillar on the driver's side (> page 290)
- in the tire pressure table in the fuel filler flap (> page 136)
- under "Tire pressure" (> page 284)

Operation

Information on driving

Check the tire pressure when the vehicle is heavily laden and adjust prior to a trip.

While driving, pay attention to vibrations, noises and unusual handling characteristics, e.g. pulling to one side. This may indicate that the wheels or tires are damaged. If you suspect that a tire is defective, reduce your speed immediately. Stop the vehicle as soon as possible to check the wheels and tires for damage. Hidden tire damage could also be causing the unusual handling characteristics. If you find no signs of damage, have the tires and wheels checked at a qualified specialist workshop.

When parking your vehicle, make sure that the tires do not get deformed by the curb or other obstacles. If they cannot be avoided, drive over obstacles such as curbs slowly and at an obtuse angle. Otherwise, you may damage the wheels or tires.

Regular checking of wheels and tires

WARNING

Damaged tires can cause tire inflation pressure loss. As a result, you could lose control of your vehicle. There is a risk of accident.

Check the tires regularly for signs of damage and replace any damaged tires immediately.

Check wheels and tires for damage at least once a month. Check wheels and tires after driving off-road or on rough roads. Damaged wheels can cause a loss of tire pressure. Pay particular attention to damage such as:

- cuts in the tires
- punctures
- tears in the tires
- bulges on tires
- deformation or severe corrosion on wheels

Regularly check the tire tread depth and the condition of the tread across the whole width of the tire (> page 282). If necessary, turn the front wheels to full lock in order to inspect the inner side of the tire surface.

All wheels must have a valve cap to protect the valve against dirt and moisture. Do not mount anything onto the valve other than the standard valve cap or other valve caps approved by Mercedes-Benz for your vehicle. Do not use any other valve caps or systems, e.g. tire pressure monitoring systems.

Regularly check the pressure of all the tires particularly prior to long trips. Adjust the tire pressure as necessary (> page 284).

Observe the notes on the emergency spare wheel (> page 304).

The service life of tires depends, among other things, on the following factors:

- driving style
- tire pressure
- distance covered

Notes on tire tread

WARNING

Insufficient tire tread will reduce tire traction. The tire is no longer able to dissipate water. This means that on wet road surfaces, the risk of hydroplaning increases, in particular where speed is not adapted to suit the driving conditions. There is a risk of accident.

If the tire pressure is too high or too low, tires may exhibit different levels of wear at different locations on the tire tread. Thus, you should regularly check the tread depth and the condition of the tread across the entire width of all tires.

Minimum tire tread depth for:

- Summer tires: $\frac{1}{8}$ in (3 mm)
- M+S tires: $\frac{1}{8}$ in (4 mm)

For safety reasons, replace the tires before the legally prescribed limit for the minimum tire tread depth is reached.

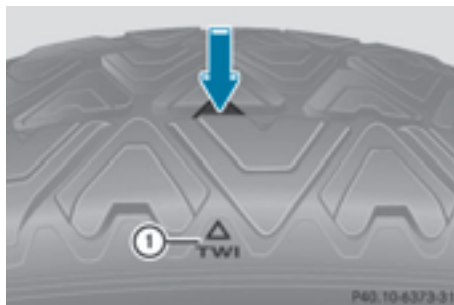

Marking ① shows where the bar indicator (arrow) for tread wear is integrated into the tire tread.

Treadwear indicators (TWI) are required by law. Six indicators are positioned on the tire tread. They are visible once a tread depth of approximately $\frac{1}{16}$ in (1.6 mm) has been reached. If this is the case, the tire is so worn that it must be replaced.

Selecting, mounting and replacing tires

- Only mount tires and wheels of the same type and make.
Exception: it is permissible to install a different type or make in the event of a flat tire. Observe the "MOExtended tires (tires with run-flat characteristics)" section (> page 266).
- Only mount tires of the correct size onto the wheels.
- Break in new tires at moderate speeds for the first 60 miles (100 km). They only reach their full performance after this distance.
- Do not drive with tires which have too little tread depth, as this significantly reduces the traction on wet roads (hydroplaning).
- Replace the tires after six years at the latest, regardless of wear.

Observe the notes on the emergency spare wheel (> page 304).

MOExtended tires (tires with run-flat properties)

With MOExtended tires (tires with run flat characteristics), you can continue to drive your vehicle even if there is a total loss of pressure in one or more tires.

MOExtended tires may only be used in conjunction with an active tire pressure monitor and only on wheels specifically tested by Mercedes-Benz.

Notes on driving with MOExtended tires with a flat tire (▷ page 266).

Vehicles equipped with MOExtended tires are not equipped with a TIREFIT kit at the factory. It is therefore recommended that you additionally equip your vehicle with a TIREFIT kit if you mount tires that do not feature run-flat properties, e.g. winter tires. A TIREFIT kit can be obtained from a qualified specialist workshop.

Winter operation

General notes

Have your vehicle winter-proofed at a qualified specialist workshop at the onset of winter.

Observe the notes in the "Changing a wheel" section (▷ page 299).

Driving with summer tires

At temperatures below 45 °F (+7 °C), summer tires lose elasticity and therefore traction and braking power. Change the tires on your vehicle to M+S tires. Using summer tires at very cold temperatures could cause cracks to form, thereby damaging the tires permanently. Mercedes-Benz cannot accept responsibility for this type of damage.

WARNING

Damaged tires can cause tire inflation pressure loss. As a result, you could lose control of your vehicle. There is a risk of accident.

Check the tires regularly for signs of damage and replace any damaged tires immediately.

M+S tires

WARNING

M+S tires with a tire tread depth of less than 1/8 in (4 mm) are not suitable for use in winter and do not provide sufficient traction. There is a risk of an accident.

M+S tires with a tread depth of less than 1/8 in (4 mm) must be replaced immediately.

At temperatures below 45 °F (+7 °C), use winter tires or all-season tires. Both types of tire are identified by the M+S marking.

Only winter tires bearing the  snowflake symbol in addition to the M+S marking provide the best possible grip in wintry road conditions.

Only these tires will allow driving safety systems such as ABS and ESP® to function optimally in winter. These tires have been developed specifically for driving in snow.

Use M+S tires of the same make and tread on all wheels to maintain safe handling characteristics.

Always observe the maximum permissible speed specified for the M+S tires you have mounted.

Once the winter tires are mounted:

- ▶ Check the tire pressures (▷ page 287).
- ▶ Restart the tire pressure monitor (▷ page 287).

For more information on driving with the emergency spare wheel, see (▷ page 304).

Snow chains

WARNING

If snow chains are installed to the front wheels, they may drag against the vehicle body or chassis components. This could cause damage to the vehicle or the tires. There is a risk of an accident.

To avoid hazardous situations:

- never install snow chains to the front wheels
- always install snow chains in pairs to the rear wheels.

! On some tire sizes there is not enough space for snow chains. To avoid damage to the vehicle or tires, observe the "Wheel and tire combinations" section under "Tires and wheels".

! **Vehicles with steel wheels:** if you mount snow chains on steel wheels, you may damage the hub caps. Remove the hub caps from the relevant wheels before mounting the snow chains.

For safety reasons, Mercedes-Benz recommends that you only use snow chains that have been specially approved for your vehicle by Mercedes-Benz, or are of a corresponding standard of quality. For more information, please contact a qualified specialist workshop. If you intend to mount snow chains, please bear the following points in mind:

- Snow chains may not be mounted on all wheel/tire combinations. Permissible wheel-tire combinations (▷ page 303).
- Only use snow chains when driving on roads completely covered by snow. Remove the snow chains as soon as possible when you come to a road that is not snow-covered.
- Local regulations may restrict the use of snow chains. Observe the appropriate regulations if you wish to mount snow chains.
- Do not exceed the maximum permissible speed of 30 mph (50 km/h).

i You may wish to deactivate ESP® when pulling away with snow chains installed (▷ page 191). You can thereby allow the wheels to spin in a controlled manner, achieving an increased driving force (cutting action).

For more information on driving with the emergency spare wheel, see (▷ page 304).

Tire pressure

Tire pressure specifications

Important safety notes

WARNING

Underinflated or overinflated tires pose the following risks:

- the tires may burst, especially as the load and vehicle speed increase.
- the tires may wear excessively and/or unevenly, which may greatly impair tire traction.
- the driving characteristics, as well as steering and braking, may be greatly impaired.

There is a risk of an accident.

Follow recommended tire inflation pressures and check the pressure of all the tires including the spare wheel:

- monthly, at least
- if the load changes
- before beginning a long journey
- under different operating conditions, e.g. off-road driving

If necessary, correct the tire pressure.

The data on the Tire and Loading Information placard and tire pressure table shown here are examples. Tire pressure specifications are vehicle-specific and may deviate from the data shown here. The tire pressure specifications that are valid for your vehicle can be found on the Tire and Loading Information placard and tire pressure table on the vehicle.

General notes

The recommended tire pressures for the tires mounted at the factory can be found on the labels described here.

Operation with an emergency spare wheel: information on operation with an emergency spare wheel can be found in the general notes in the "Emergency spare wheel" section (▷ page 304).

Further information on tire pressures can be obtained at a qualified specialist workshop.

Tire and Loading Information placard

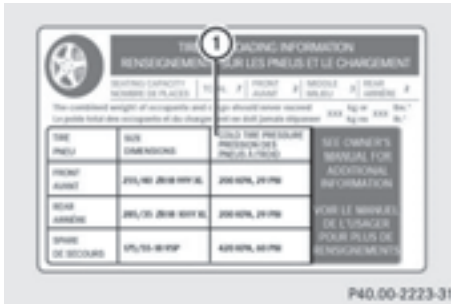

① Recommended tire pressures

The Tire and Loading Information placard is on the B-pillar on the driver's side (▷ page 290). The Tire and Loading Information placard contains the recommended tire pressures for cold tires. The recommended tire pressures are valid for the maximum permissible load and up to the maximum permissible vehicle speed.

Tire pressure table

The tire pressure table is on the inside of the fuel filler flap. It shows the tire pressure for all tires permitted at the factory for this vehicle; see illustration (example).

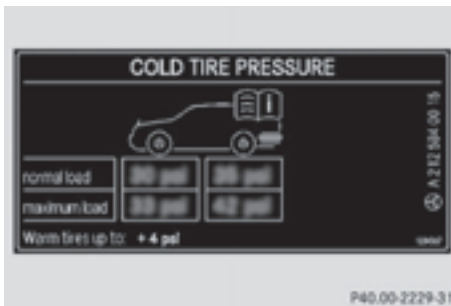

The tire pressure table contains the recommended pressures for cold tires for various operating conditions, i.e. differing load and speed conditions.

If a tire size precedes a tire pressure, the following tire pressure information is only valid for that tire size; see illustration (example).

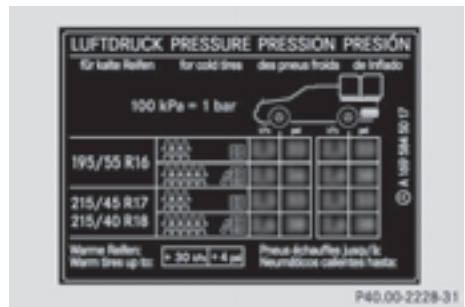

The load conditions "partially laden" and "fully laden" are defined in the table for different numbers of occupants and amounts of luggage. The actual number of seats may differ.

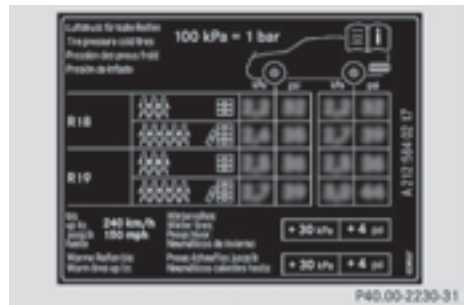

Some tire pressure tables show only the rim diameters instead of the full tire size, e.g. **R18**. Rim diameter is part of the tire size and can be found on the tire sidewall (▷ page 294). If the tire pressures have been set to the lower values for lighter loads and/or lower road speeds, the pressures should be reset to the higher values:

- if you want to drive with an increased load and/or
- if you want to drive at higher road speeds

The tire pressures for increased loads and/or higher road speeds, shown in the tire pressure table, may have a negative effect on driving comfort.

If the tire pressure is not set correctly, this can lead to an excessive build up of heat and a sudden loss of pressure.

For more information, contact a qualified specialist workshop.

Important notes on tire pressure

WARNING

If the tire pressure drops repeatedly, the wheel, valve or tire may be damaged. Tire pressure that is too low may result in a tire blow-out. There is a risk of an accident.

- Check the tire for foreign objects.
- Check whether the wheel is losing air or the valve is leaking.

If you are unable to rectify the damage, contact a qualified specialist workshop.

WARNING

If you fit unsuitable accessories onto tire valves, the tire valves may be overloaded and malfunction, which can cause tire pressure loss. Due to their design, retrofitted tire pressure monitors keep the tire valve open. This can also result in tire pressure loss. There is a risk of an accident.

Only screw the standard valve cap or other valve caps approved by Mercedes-Benz for your vehicle onto the tire valve.

Use a suitable pressure gauge to check the tire pressure. The outer appearance of a tire does not permit any reliable conclusion about the tire pressure. On vehicles equipped with the electronic tire pressure monitor, the tire pressure can be checked in the on-board computer.

The tire temperature and pressure increase when the vehicle is in motion. This is dependent on the driving speed and the load.

Therefore, you should only correct tire pressures when the tires are cold.

The tires are cold:

- if the vehicle has been parked with the tires out of direct sunlight for at least three hours and
- if the vehicle has not been driven further than 1 mile (1.6 km)

The tire temperature changes depending on the outside temperature, the vehicle speed and the tire load. If the tire temperature changes by 18 °F (10 °C), the tire pressure changes by approximately 10 kPa (0.1 bar/1.5 psi). Take this into account when checking the pressure of warm tires. Only correct the tire pressure if it is

too low for the current operating conditions. If you check the tire pressure when the tires are warm, the resulting value will be higher than if the tires were cold. This is normal. Do not reduce the tire pressure to the value specified for cold tires. The tire pressure would otherwise be too low.

Observe the recommended tire pressures for cold tires:

- on the Tire and Loading Information placard on the B-pillar on the driver's side
- in the tire pressure table on the fuel filler flap (▷ page 136)

Underinflated or overinflated tires

Underinflated tires

WARNING

Tires with pressure that is too low can overheat and burst as a consequence. In addition, they also suffer from excessive and/or irregular wear, which can severely impair the braking properties and the driving characteristics. There is a risk of an accident.

Avoid tire pressures that are too low in all the tires, including the spare wheel.

Underinflated tires may:

- overheat, leading to tire defects
- adversely affect handling
- wear excessively and/or unevenly
- have an adverse effect on fuel consumption

Overinflated tires

WARNING

Tires with excessively high pressure can burst because they are damaged more easily by road debris, potholes etc. In addition, they also suffer from irregular wear, which can severely impair the braking properties and the driving characteristics. There is a risk of an accident.

Avoid tire pressures that are too high in all the tires, including the spare wheel.

Overinflated tires may:

- increase the braking distance
- adversely affect handling
- wear excessively and/or unevenly
- have an adverse effect on ride comfort
- be more susceptible to damage

Maximum tire pressures

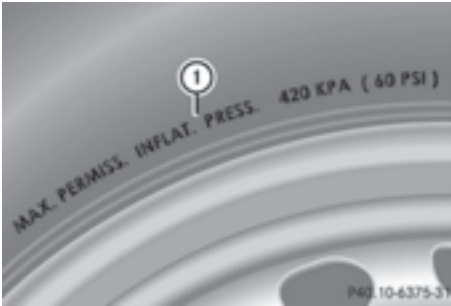

① Example: maximum permissible tire pressure

Never exceed the maximum permissible tire inflation pressure. Always observe the recommended tire pressure for your vehicle when adjusting the tire pressure (> page 284).

i The actual values for tires are vehicle-specific and may deviate from the values in the illustration.

Checking the tire pressures

Important safety notes

Observe the notes on tire pressure (> page 284).

Information on air pressure for the tires on your vehicle can be found:

- on the vehicle's Tire and Loading Information placard on the B-pillar
- in the tire pressure table in the fuel filler flap (> page 136)
- in the "Tire pressure" section

Checking tire pressures manually

To determine and set the correct tire pressure, proceed as follows:

- ▶ Remove the valve cap of the tire that is to be checked.
- ▶ Press the tire pressure gauge securely onto the valve.
- ▶ Read the tire pressure and compare it to the recommended value on the Tire and Loading Information placard or the tire pressure table (> page 284).
- ▶ If the tire pressure is too low, increase the tire pressure to the recommended value.
- ▶ If the tire pressure is too high, release air. To do so, press down the metal pin in the valve, using the tip of a pen for example. Then check the tire pressure again using the tire pressure checker.
- ▶ Screw the valve cap onto the valve.
- ▶ Repeat these steps for the other tires.

Tire pressure monitor

General notes

If a tire pressure monitor is installed, the vehicle's wheels have sensors that monitor the tire pressures in all four tires. The tire pressure monitor warns you if the pressure drops in one or more of the tires. The tire pressure monitor only functions if the corresponding sensors are installed in all wheels.

Information on tire pressures is displayed in the multifunction display. After a few minutes of driving, the current tire pressure of each tire is shown in the **Service** menu of the multifunction display, see illustration (example).



For information on the message display, refer to the "Checking the tire pressure electronically" section (> page 289).

Important safety notes

WARNING

Each tire, including the spare (if provided), should be checked at least once a month when cold and inflated to the pressure recommended by the vehicle manufacturer on the Tire and Loading Information placard on the driver's door B-pillar or the tire pressure label on the inside of the fuel filler flap. If your vehicle has tires of a different size than the size indicated on the Tire and Loading Information placard or the tire pressure label, you should determine the proper tire pressure for those tires.

As an added safety feature, your vehicle has been equipped with a tire pressure monitoring system (TPMS) that illuminates a low tire pressure telltale when one or more of your tires are significantly underinflated. Accordingly, when the low tire pressure telltale illuminates, you should stop and check your tires as soon as possible, and inflate them to the proper pressure. Driving on a significantly underinflated tire causes the tire to overheat and can lead to tire failure. Underinflation also reduces fuel efficiency and tire tread life, and may affect the vehicle's handling and stopping ability.

Please note that the TPMS is not a substitute for proper tire maintenance, and it is the driver's responsibility to maintain correct tire pressure, even if underinflation has not reached the level to trigger illumination of the TPMS low tire pressure telltale.

Your vehicle has also been equipped with a TPMS malfunction indicator to indicate if the system is not operating properly. The TPMS malfunction indicator is combined with the low tire pressure telltale. When the system detects a malfunction, the warning lamp will flash for approximately a minute and then remain continuously illuminated. This sequence will be repeated every time the vehicle is started as long as the malfunction exists.

When the malfunction indicator is illuminated, the system may not be able to detect or signal low tire pressure as intended. TPMS malfunctions may occur for a variety of reasons, including the installation of incompatible replacement or alternate tires or wheels on the vehicle that prevent the TPMS from functioning properly. Always check the TPMS malfunction telltale after replacing one or more tires or wheels on your vehicle to ensure that the replacement or alternate tires and wheels allow the TPMS to continue to function properly.

It is the driver's responsibility to set the tire pressure to that recommended for cold tires which is suitable for the operating situation (> page 284). Note that the correct tire pressure for the current operating situation must first be taught-in to the tire pressure monitor. If there is a substantial loss of pressure, the warning threshold for the warning message is aligned to the reference values taught-in. Restart the tire pressure monitor after adjusting the pressure of the cold tires (> page 289). The current pressures are saved as new reference values. As a result, a warning message will appear if the tire pressure drops significantly.

The tire pressure monitor does not warn you of an incorrectly set tire pressure. Observe the notes on the recommended tire pressure (> page 284).

The tire pressure monitor is not able to warn you of a sudden loss of pressure, e.g. if the tire is penetrated by a foreign object. In the event of a sudden loss of pressure, bring the vehicle to a halt by braking carefully. Avoid abrupt steering movements.

The tire pressure monitor has a yellow warning lamp in the instrument cluster for indicating pressure loss or a malfunction. Whether the warning lamp flashes or lights up indicates whether a tire pressure is too low or the tire pressure monitor is malfunctioning:

- if the warning lamp is lit continuously, the tire pressure on one or more tires is significantly too low. The tire pressure monitor is not malfunctioning.
- if the warning lamp flashes for around a minute and then remains lit constantly, the tire pressure monitor is malfunctioning.





In addition to the warning lamp, a message appears in the multifunction display. Observe the information on display messages (▷ page 214).

It may take up to ten minutes for a malfunction of the tire pressure monitor to be indicated. A malfunction will be indicated by the tire pressure warning lamp flashing for approximately one minute and then remaining lit. When the malfunction has been rectified, the tire pressure warning lamp goes out after a few minutes of driving.

The tire pressure values indicated by the on-board computer may differ from those measured at a gas station with a pressure gauge. The tire pressures shown by the on-board computer refer to those measured at sea level. At high altitudes, the tire pressure values indicated by a pressure gauge are higher than those shown by the on-board computer. In this case, do not reduce the tire pressures.

The operation of the tire pressure monitor can be affected by interference from radio transmitting equipment (e.g. radio headphones, two-way radios) that may be being operated in or near the vehicle.

Checking the tire pressure electronically

- ▶ Make sure that the SmartKey is in position **2** in the ignition lock (▷ page 122).
- ▶ Press the  or  button on the steering wheel to select the **Service** menu.
- ▶ Press the  or  button to select **Tire Pressure**.
- ▶ Press the  button.

The current tire pressure of each tire is shown in the multifunction display.

If the vehicle has been parked for over 20 minutes, the **Tire pressures will be displayed after driving a few minutes** message appears.

After a teach-in process, the tire pressure monitor automatically detects new wheels or new sensors. As long as a clear allocation of the tire pressure value to the individual wheels is not possible, the **Tire Pressure Monitor Active** display message is shown instead of the tire pressure display. The tire pressures are already being monitored.

If an emergency spare wheel is mounted, the system may continue to show the tire pressure

of the wheel that has been removed for a few minutes. If this occurs, note that the value displayed for the position where the spare wheel is mounted is not the same as the current tire pressure of the emergency spare wheel.

Tire pressure monitor warning messages

If the tire pressure monitor detects a pressure loss in one or more tires, a warning message is shown in the multifunction display. The yellow tire pressure warning lamp then lights up.

- If the **Correct Tire Pressure** message appears in the multifunction display, the tire pressure in at least one tire is too low. The tire pressure must be corrected when the opportunity arises.
- If the **Check Tires** message appears in the multifunction display, the tire pressure in one or more tires has dropped significantly. The tires must be checked.
- If the **Warning Tire Malfunction** message appears in the multifunction display, the tire pressure in one or more tires is dropping suddenly. The tires must be checked.

Observe the instructions and safety notes in the display messages in the "Tires" section (▷ page 214).

If the wheel positions on the vehicle are rotated, the tire pressures may be displayed for the wrong positions for a short time. This is rectified after a few minutes of driving, and the tire pressures are displayed for the correct positions.

Restarting the tire pressure monitor

When you restart the tire pressure monitor, all existing warning messages are deleted and the warning lamps go out. The monitor uses the currently set tire pressures as the reference values for monitoring. In most cases, the tire pressure monitor will automatically detect the new reference values after you have changed the tire pressure. However, you can also define reference values manually as described here. The tire pressure monitor then monitors the new tire pressure values.

- ▶ Set the tire pressure to the value recommended for the corresponding driving situation on the Tire and Loading Information placard on the driver's side B-pillar (▷ page 284).

You can find more tire pressure values for various operating conditions in the tire pressure table inside the fuel filler flap (> page 284).

- ▶ Make sure that the tire pressure is correct on all four wheels.
- ▶ Make sure that the SmartKey is in position **2** in the ignition lock.
- ▶ Press the ◀ or ▶ button on the steering wheel to select the **Service** menu.
- ▶ Press the ▲ or ▼ button to select **Tire Pressure**.
- ▶ Press the **OK** button.
The multifunction display shows the current tire pressure for the individual tires or the **Tire pressures will be displayed after driving a few minutes** message.
- ▶ Press the ▼ button.
The **Use Current Pressures as New Reference Values** message appears in the multifunction display.

If you wish to confirm the restart:

- ▶ Press the **OK** button.
The **Tire Press. Monitor Restarted** message appears in the multifunction display.
After driving for a few minutes, the system checks whether the current tire pressures are within the specified range. The new tire pressures are then accepted as reference values and monitored.

If you wish to cancel the restart:

- ▶ Press the ↩ button.
The tire pressure values stored at the last restart will continue to be monitored.

Two instruction labels on your vehicle show the maximum possible load.

- (1) The Tire and Loading Information placard is on the B-pillar on the driver's side. The Tire and Loading Information placard shows the maximum permissible number of occupants and the maximum permissible vehicle load. It also contains details of the tire sizes and corresponding pressures for tires mounted at the factory.
- (2) The vehicle identification plate is on the B-pillar on the driver's side. The vehicle identification plate informs you of the gross vehicle weight rating. It is made up of the vehicle weight, all vehicle occupants, the fuel and the cargo. You can also find information about the maximum gross axle weight rating on the front and rear axle.
The maximum gross axle weight rating is the maximum weight that can be carried by one axle (front or rear axle). Never exceed the maximum load or the maximum gross axle weight rating for the front or rear axle.



① B-pillar, driver's side

Loading the vehicle

Instruction labels for tires and loads

⚠ WARNING

Overloaded tires can overheat, causing a blowout. Overloaded tires can also impair the steering and driving characteristics and lead to brake failure. There is a risk of accident.

Observe the load rating of the tires. The load rating must be at least half of the GAWR of your vehicle. Never overload the tires by exceeding the maximum load.

Maximum permissible gross vehicle weight rating

| TIRE AND LOADING INFORMATION | | RENSEIGNEMENTS POUR LES PNEUS ET LE CHARGEMENT | |
|------------------------------|----------------------------------|--|----------------------------------|
| PLACARD | MAX. OCCUPANTS | 2015 TIRE PRESSURE | MAX. GROSS VEHICLE WEIGHT RATING |
| PLACARD | MAX. GROSS VEHICLE WEIGHT RATING | 2015 TIRE PRESSURE | MAX. GROSS VEHICLE WEIGHT RATING |
| PLACARD | MAX. GROSS VEHICLE WEIGHT RATING | 2015 TIRE PRESSURE | MAX. GROSS VEHICLE WEIGHT RATING |
| PLACARD | MAX. GROSS VEHICLE WEIGHT RATING | 2015 TIRE PRESSURE | MAX. GROSS VEHICLE WEIGHT RATING |
| PLACARD | MAX. GROSS VEHICLE WEIGHT RATING | 2015 TIRE PRESSURE | MAX. GROSS VEHICLE WEIGHT RATING |
| PLACARD | MAX. GROSS VEHICLE WEIGHT RATING | 2015 TIRE PRESSURE | MAX. GROSS VEHICLE WEIGHT RATING |

- Specification for maximum gross vehicle weight ① is listed in the Tire and Loading Information placard: "The combined weight of occupants and cargo should never exceed XXX kilograms or XXX lbs."

The gross weight of all vehicle occupants, load and luggage must not exceed the specified value.

- ① The specifications shown on the Tire and Loading Information placard in the illustration are examples. The maximum permissible gross vehicle weight rating is vehicle-specific and may differ from that in the illustration. You can find the valid maximum permissible gross vehicle weight rating for your vehicle on the Tire and Loading Information placard.

Number of seats

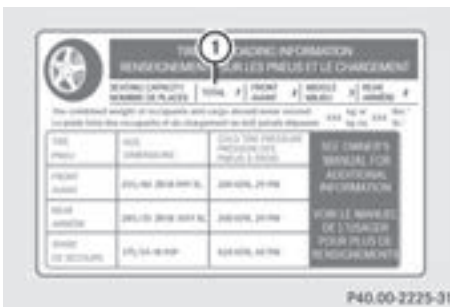

Maximum number of seats ① indicates the maximum number of occupants allowed to travel in the vehicle. This information can be found on the Tire and Loading Information placard.

- ① The specifications shown on the Tire and Loading Information placard in the illustration are examples. The number of seats is vehicle-specific and can differ from the details shown. The number of seats in your vehicle can be found on the Tire and Loading Information placard.

Determining the correct load limit

Step-by-step instructions

The following steps have been developed as required of all manufacturers under Title 49, Code of U.S. Federal Regulations, Part 575 pur-

suant to the "National Traffic and Motor Vehicle Safety Act of 1966".

- **Step 1:** Locate the statement "The combined weight of occupants and cargo should never exceed XXX kg or XXX lbs." on your vehicle's Tire and Loading Information placard.
- **Step 2:** Determine the combined weight of the driver and passengers that will be riding in your vehicle.
- **Step 3:** Subtract the combined weight of the driver and passengers from XXX kilograms or XXX lbs.
- **Step 4:** The resulting figure equals the available amount of cargo and luggage load capacity. For example, if the "XXX" amount equals 1400 lbs and there will be five 150-lb passengers in your vehicle, the amount of available cargo and luggage load capacity is 650 lbs ($1400 - 750 (5 \times 150) = 650$ lbs).
- **Step 5:** Determine the combined weight of luggage and cargo being loaded on the vehicle. That weight may not safely exceed the available cargo and luggage load capacity calculated in step 4.

Example: steps 1 to 3

The following table shows examples on how to calculate total and cargo load capacities with varying seating configurations and number and size of occupants. The following examples use a load limit of 1500 lbs (680 kg). **This is for illustration purposes only.** Make sure you are using the actual load limit for your vehicle stated on your vehicle's Tire and Loading Information placard (▷ page 290). The greater the combined weight of the occupants, the lower the maximum luggage load.

Step 1

| | Example 1 | Example 2 | Example 3 |
|--|-------------------|-------------------|-------------------|
| Combined maximum weight of occupants and cargo (data from the Tire and Loading Information placard) | 1500 lbs (680 kg) | 1500 lbs (680 kg) | 1500 lbs (680 kg) |

Step 2

| | Example 1 | Example 2 | Example 3 |
|---|---|---|-----------------------------|
| Number of people in the vehicle (driver and occupants) | 5 | 3 | 1 |
| Distribution of the occupants | Front: 2 Rear: 3 | Front: 1 Rear: 2 | Front: 1 |
| Weight of the occupants | Occupant 1: 150 lbs (68 kg) Occupant 2: 180 lbs (82 kg) Occupant 3: 160 lbs (73 kg) Occupant 4: 140 lbs (63 kg) Occupant 5: 120 lbs (54 kg) | Occupant 1: 200 lbs (91 kg) Occupant 2: 190 lbs (86 kg) Occupant 3: 150 lbs (68 kg) | Occupant 1: 150 lbs (68 kg) |
| Gross weight of all occupants | 750 lbs (340 kg) | 540 lbs (245 kg) | 150 lbs (68 kg) |

Step 3

| | Example 1 | Example 2 | Example 3 |
|---|---|---|---|
| Permissible load (maximum gross vehicle weight rating from the Tire and Loading Information placard minus the gross weight of all occupants) | 1500 lbs (680 kg) - 750 lbs (340 kg) = 750 lbs (340 kg) | 1500 lbs (680 kg) - 540 lbs (245 kg) = 960 lbs (435 kg) | 1500 lbs (680 kg) - 150 lbs (68 kg) = 1350 lbs (612 kg) |

Vehicle identification plate

Even if you have calculated the total cargo carefully, you should still make sure that the gross vehicle weight rating and the gross axle weight rating are not exceeded. Details can be found on the vehicle identification plate on the B-pillar on the driver's side of the vehicle (▷ page 290).

Permissible Gross Vehicle Weight Rating (GVWR): the gross weight of the vehicle, all passengers, load and trailer load/noseweight (if applicable) must not exceed the permissible gross vehicle weight.

Gross Axle Weight Rating (GAWR): the maximum permissible weight that can be carried by one axle (front or rear axle).

To ensure that your vehicle does not exceed the maximum permissible values (gross vehicle weight and maximum gross axle weight rating), have your loaded vehicle (including driver, occupants, cargo, and full trailer load if applicable) weighed on a suitable vehicle weighbridge.

All about wheels and tires

Uniform Tire Quality Grading Standards

Overview of Tire Quality Grading Standards

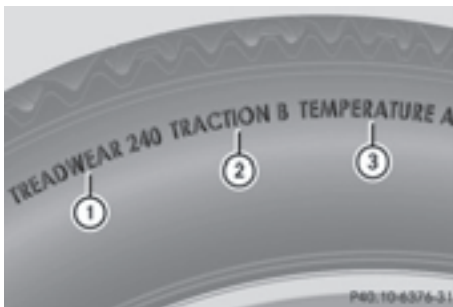

Uniform Tire Quality Grading Standards are U.S. government specifications. Their purpose is to provide drivers with uniform reliable information on tire performance data. Tire manufacturers have to grade tires using three performance factors: ① tread wear grade, ② traction grade and ③ temperature grade. These regulations do not apply to Canada. Nevertheless, all tires sold in North America are provided with the corre-

sponding quality grading markings on the sidewall of the tire.

Quality grades can be found, where applicable, on the tire sidewall between tread shoulder and maximum section width.

Example:

- **Treadwear grade:** 200
- **Traction grade:** AA
- **Temperature grade:** A

All passenger car tires must conform to the statutory safety requirements in addition to these grades.

- i** The actual values for tires are vehicle-specific and may deviate from the values in the illustration.

Treadwear

The treadwear grade is a comparative rating based on the wear rate of the tire when tested under controlled conditions on a specified U.S. government course. For example, a tire graded 150 would wear one and one-half times as well on the government course as a tire graded 100.

The relative performance of tires depends upon the actual conditions of their use, however, and may depart significantly from the norm due to variations in driving habits, service practices and differences in road characteristics and climate.

Traction

WARNING

The traction grade assigned to this tire is based on straight-ahead braking traction tests, and does not include acceleration, cornering, hydroplaning, or peak traction characteristics.

- !** Avoid wheelspin. This can lead to damage to the drive train.

The traction grades – from highest to lowest – are AA, A, B and C. Those grades represent the tire's ability to stop on wet pavement as measured under controlled conditions on specified government test surfaces of asphalt and concrete. A tire marked C may have poor traction performance.

The safe speed on a wet, snow covered or icy road is always lower than on dry road surfaces.

You should pay special attention to road conditions when temperatures are around freezing point.

Mercedes-Benz recommends a minimum tread depth of $\frac{1}{8}$ in (4 mm) on all four winter tires. Observe the legally required minimum tire tread depth (▷ page 282). Winter tires can reduce the braking distance on snow-covered surfaces in comparison with summer tires. The braking distance is still much further than on surfaces that are not icy or covered with snow. Take appropriate care when driving.

Further information on winter tires (M+S tires) (▷ page 283).

Temperature

WARNING

The temperature grade for this tire is established for a tire that is properly inflated and not overloaded. Excessive speed, underinflation, or excessive loading, either separately or in combination, can cause excessive heat build-up and possible tire failure.

The temperature grades are A (the highest), B, and C, representing the tire's resistance to the generation of heat and its ability to dissipate heat when tested under controlled conditions on a specified indoor laboratory test wheel. Sustained high temperature can cause the material of the tire to degenerate and reduce tire life, and excessive temperature can lead to sudden tire failure. The grade C corresponds to a level of performance which all passenger car tires must meet under the Federal Motor Vehicle Safety Standard No. 109. Grades B and A represent higher levels of performance on the laboratory test wheel than the minimum required by law.

Tire labeling

Overview

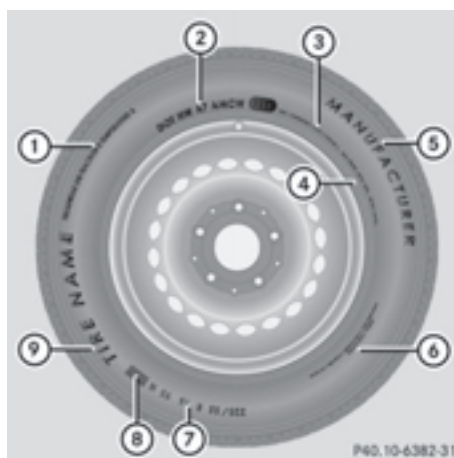

- ① Uniform Tire Quality Grading Standards (▷ page 297)
- ② Department of Transportation, Tire Identification Number (▷ page 297)
- ③ Maximum load rating (▷ page 296)
- ④ Maximum tire pressures (▷ page 287)
- ⑤ Manufacturer
- ⑥ Tire material (▷ page 297)
- ⑦ Tire size designation, load-bearing capacity and speed rating (▷ page 294)
- ⑧ Load index (▷ page 296)
- ⑨ Tire name

The markings described above are on the tire in addition to the tire name (sales designation) and the manufacturer's name.

 Tire data is vehicle-specific and may deviate from the data in the example.

Tire size designation, load-bearing capacity and speed rating

WARNING

Exceeding the stated tire load-bearing capacity and the approved maximum speed could lead to tire damage or the tire bursting. There is a risk of accident.

Therefore, only use tire types and sizes approved for your vehicle model. Observe the

tire load rating and speed rating required for your vehicle.

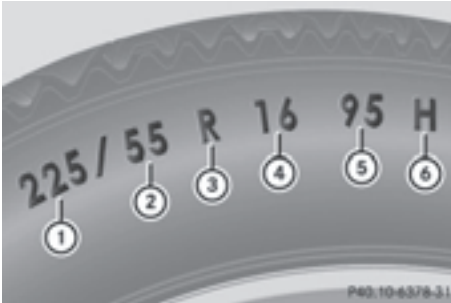

- ① Tire width
- ② Nominal aspect ratio in %
- ③ Tire code
- ④ Rim diameter
- ⑤ Load bearing index
- ⑥ Speed rating

General: depending on the manufacturer's standards, the size imprinted in the tire wall may not contain any letters or may contain one letter that precedes the size description.

If there is no letter preceding the size description (as shown above): these are passenger vehicle tires according to European manufacturing standards.

If "P" precedes the size description: these are passenger vehicle tires according to U.S. manufacturing standards.

If "LT" precedes the size description: these are light truck tires according to U.S. manufacturing standards.

If "T" precedes the size description: compact emergency wheels with high tire pressure that are only designed for temporary use in an emergency.

Tire width: tire width ① shows the nominal tire width in millimeters.

Aspect ratio: aspect ratio ② is the size ratio between the tire height and tire width and is shown in percent. The aspect ratio is calculated by dividing the tire width by the tire height.

Tire code: tire code ③ specifies the tire type. "R" represents radial tires; "D" represents diagonal tires; "B" represents diagonal radial tires.

Rim diameter: rim diameter ④ is the diameter of the bead seat, not the diameter of the rim

flange. The rim diameter is specified in inches (in).

Load-bearing index: load-bearing index ⑤ is a numerical code that specifies the maximum load-bearing capacity of a tire.

Do not overload the tires by exceeding the specified load limit. The maximum permissible load can be found on the vehicle's Tire and Loading Information placard on the B-pillar on the driver's side (▷ page 290).

Example:

Load-bearing index 91 indicates a maximum load of 1,356 lb (615 kg) that the tires can bear. For further information on the maximum tire load in kilograms and lbs, see (▷ page 296).

For further information on the load bearing index, see "Load index" (▷ page 296).

Speed rating: speed rating ⑥ specifies the approved maximum speed of the tire.

- ❗ Tire data is vehicle-specific and may deviate from the data in the example.

Regardless of the speed rating, always observe the speed limits. Drive carefully and adapt your driving style to the traffic conditions.

Summer tires

| Index | Speed rating |
|------------|--------------------------|
| Q | up to 100 mph (160 km/h) |
| R | up to 106 mph (170 km/h) |
| S | up to 112 mph (180 km/h) |
| T | up to 118 mph (190 km/h) |
| H | up to 130 mph (210 km/h) |
| V | up to 149 mph (240 km/h) |
| W | up to 168 mph (270 km/h) |
| Y | up to 186 mph (300 km/h) |
| ZR...Y | up to 186 mph (300 km/h) |
| ZR...(..Y) | over 186 mph (300 km/h) |
| ZR | over 149 mph (240 km/h) |

- Optionally, tires with a maximum speed of over 149 mph (240 km/h) may have "ZR" in the size description, depending on the manufacturer (e.g. 245/40 ZR 18).
- If a service specification is available, the maximum speed is limited according to the speed

rating in the service specification. Example: 245/40 ZR18 97 Y. In this example, "97 Y" is the service specification. The letter "Y" represents the speed rating. The maximum speed of the tire is limited to 186 mph (300 km/h).

If the size description of your tire includes "ZR" and there are no service specifications, ask the tire manufacturer in order to find out the maximum speed.

- The size description for all tires with maximum speeds of over 186 mph (300 km/h) must include "ZR", **and** the service specification must be given in parentheses. Example: 275/40 ZR 18 (99 Y). Speed rating "(Y)" indicates that the maximum speed of the tire is over 186 mph (300 km/h). Ask the tire manufacturer about the maximum speed.

All-weather tires and winter tires

| Index | Speed rating |
|--------------------|--------------------------|
| Q M+S ¹ | up to 100 mph (160 km/h) |
| T M+S ¹ | up to 118 mph (190 km/h) |
| H M+S ¹ | up to 130 mph (210 km/h) |
| V M+S ¹ | up to 149 mph (240 km/h) |

- i** Not all tires with the M+S marking provide the driving characteristics of winter tires. In addition to the M+S marking, winter tires also have the  snowflake symbol on the tire wall. Tires with this marking fulfill the requirements of the Rubber Manufacturers Association (RMA) and the Rubber Association of Canada (RAC) regarding the tire traction on snow. They have been especially developed for driving on snow.

An electronic speed limiter prevents your vehicle from exceeding a speed of 130 mph (210 km/h).

The speed rating of tires mounted at the factory may be higher than the maximum speed that the electronic speed limiter permits.

Make sure that your tires have the required speed rating, e.g. when buying new tires. The required speed rating for your vehicle can be found in the "Tires" section (▷ page 303).

Further information about reading tire data can be obtained from any qualified specialist workshop.

Load index



In addition to the load bearing index, load index ① may be imprinted after the letters that identify speed index ⑥ on the sidewall of the tire (▷ page 294).

- If no specification is given: no text (as in the example above), represents a standard load (SL) tire
- XL or Extra Load: represents a reinforced tire
- Light Load: represents a light load tire
- C, D, E: represents a load range that depends on the maximum load that the tire can carry at a certain pressure

- i** Tire data is vehicle-specific and may deviate from the data in the example.

Maximum load rating

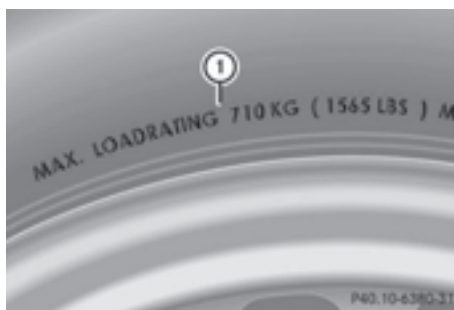

Maximum tire load ① is the maximum permissible weight for which the tire is approved.

Do not overload the tires by exceeding the specified load limit. The maximum permissible

¹ Or M+S  for winter tires.

load can be found on the vehicle's Tire and Loading Information placard on the B-pillar on the driver's side (▷ page 290).

- i** The actual values for tires are vehicle-specific and may deviate from the values in the illustration.

DOT, Tire Identification Number (TIN)

US tire regulations stipulate that every tire manufacturer or retreader must imprint a TIN in or on the sidewall of each tire produced.

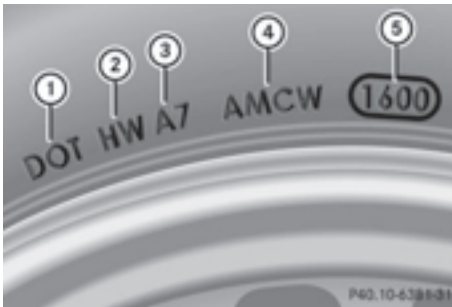

The TIN is a unique identification number. The TIN enables the tire manufacturers or retreaders to inform purchasers of recalls and other safety-relevant matters. It makes it possible for the purchaser to easily identify the affected tires. The TIN is made up of manufacturer identification code (2), tire size (3), tire type code (4) and manufacturing date (5).

DOT (Department of Transportation): tire symbol (1) marks that the tire complies with the requirements of the U.S. Department of Transportation.

Manufacturer identification code: manufacturer identification code (2) provides details on the tire manufacturer. New tires have a code with two symbols. Retreaded tires have a code with four symbols.

For further information about retreaded tires, see (▷ page 303).

Tire size: identifier (3) describes the tire size.

Tire type code: tire type code (4) can be used by the manufacturer as a code to describe specific characteristics of the tire.

Date of manufacture: date of manufacture (5) provides information about the age of a tire. The first and second positions represent the week of manufacture, starting with "01" for the first calendar week. Positions three and four represent

the year of manufacture. For example, a tire that is marked "2614" was manufactured in week 26 in 2014.

- i** Tire data is vehicle-specific and may deviate from the data in the example.

Tire characteristics



This information describes the type of tire cord and the number of layers in sidewall (1) and under tire tread (2).

- i** Tire data is vehicle-specific and may deviate from the data in the example.

Definition of terms for tires and loading

Tire ply composition and material used

Describes the number of plies or the number of layers of rubber-coated fabric in the tire tread and sidewall. These are made of steel, nylon, polyester and other materials.

Bar

Metric unit for tire pressure. 14.5038 pounds per square inch (psi) and 100 kilopascals (kPa) are the equivalent of 1 bar.

DOT (Department of Transportation)

DOT-marked tires fulfill the requirements of the U S Department of Transportation.

Normal occupant weight

The number of occupants for which the vehicle is designed multiplied by 68 kilograms (150 lbs).

Uniform Tire Quality Grading Standards

A uniform standard to grade the quality of tires with regards to tread quality, tire traction and temperature characteristics. The quality grading assessment is made by the manufacturer

following specifications from the U.S. government. The ratings are molded into the sidewall of the tire.

Recommended tire pressures

The recommended tire pressure applies to the tires mounted at the factory.

The Tire and Loading Information placard contains the recommended tire pressures for cold tires on a fully loaded vehicle and for the maximum permissible vehicle speed.

The tire pressure table contains the recommended pressures for cold tires for various operating conditions, i.e. differing load and speed conditions.

Increased vehicle weight due to optional equipment

The combined weight of all standard and optional equipment available for the vehicle, regardless of whether it is actually installed on the vehicle or not.

Rim

This is the part of the wheel on which the tire is mounted.

GAWR (Gross Axle Weight Rating)

The GAWR is the maximum gross axle weight rating. The actual load on an axle must never exceed the gross axle weight rating. The gross axle weight rating can be found on the vehicle identification plate on the B-pillar on the driver's side.

Speed rating

The speed rating is part of the tire identification. It specifies the speed range for which the tire is approved.

GVW (Gross Vehicle Weight)

The gross vehicle weight includes the weight of the vehicle including fuel, tools, the spare wheel, accessories installed, occupants, luggage and the drawbar noseweight, if applicable. The gross vehicle weight must not exceed the gross vehicle weight rating GVWR as specified on the vehicle identification plate on the B-pillar on the driver's side.

GVWR (Gross Vehicle Weight Rating)

The GVWR is the maximum permissible gross weight of a fully loaded vehicle (the weight of the vehicle including all accessories, occupants,

fuel, luggage and the drawbar noseweight, if applicable). The gross vehicle weight rating is specified on the vehicle identification plate on the B-pillar on the driver's side.

Maximum loaded vehicle weight

The maximum weight is the sum of:

- the curb weight of the vehicle
- the weight of the accessories
- the load limit
- the weight of the factory installed optional equipment

Kilopascal (kPa)

Metric unit for tire pressure. 6.9 kPa corresponds to 1 psi. Another unit for tire pressure is bar. 100 kilopascals (kPa) are the equivalent of 1 bar.

Load index

In addition to the load-bearing index, the load index may also be imprinted on the sidewall of the tire. This specifies the load-bearing capacity more precisely.

Curb weight

The weight of a vehicle with standard equipment including the maximum capacity of fuel, oil and coolant. It also includes the air-conditioning system and optional equipment if these are installed in the vehicle, but does not include passengers or luggage.

Maximum load rating

The maximum tire load is the maximum permissible weight in kilograms or lbs for which a tire is approved.

Maximum permissible tire pressure

Maximum permissible tire pressure for one tire.

Maximum load on one tire

Maximum load on one tire. This is calculated by dividing the maximum axle load of one axle by two.

PSI (pounds per square inch)

A standard unit of measure for tire pressure.

Aspect ratio

Relationship between tire height and tire width in percent.

tire pressure

Pressure inside the tire applying an outward force to every square inch of the tire's surface. The tire pressure is specified in pounds per square inch (psi), in kilopascal (kPa) or in bar. The tire pressure should only be corrected when the tires are cold.

Cold tire pressure

The tires are cold:

- if the vehicle has been parked with the tires out of direct sunlight for at least three hours and
- if the vehicle has not been driven further than 1 mile (1.6 km)

Tread

The part of the tire that comes into contact with the road.

Bead

The tire bead ensures that the tire sits securely on the wheel. There are several steel wires in the bead to prevent the tire from coming loose from the wheel rim.

Sidewall

The part of the tire between the tread and the bead.

Weight of optional extras

The combined weight of those optional extras that weigh more than the replaced standard parts and more than 2.3 kg (5 lbs). These optional extras, such as high-performance brakes, level control, a roof rack or a high-performance battery, are not included in the curb weight and the weight of the accessories.

TIN (Tire Identification Number)

This is a unique identifier which can be used by a tire manufacturer to identify tires, for example for a product recall, and thus identify the purchasers. The TIN is made up of the manufacturer's identity code, tire size, tire type code and the manufacturing date.

Load bearing index

The load bearing index (also load index) is a code that contains the maximum load bearing capacity of a tire.

Traction

Traction is the result of friction between the tires and the road surface.

Treadwear indicators

Narrow bars (tread wear bars) that are distributed over the tire tread. If the tire tread is level with the bars, the wear limit of $\frac{1}{16}$ in (1.6 mm) has been reached.

Occupant distribution

The distribution of occupants in a vehicle at their designated seating positions.

Total load limit

Nominal load and luggage load plus 68 kg (150 lbs) multiplied by the number of seats in the vehicle.

Changing a wheel

Flat tire

The "Breakdown assistance" section ([▷ page 266](#)) contains information and notes on how to deal with a flat tire. Information on driving with MOExtended tires in the event of a flat tire can be found under "MOExtended tires (tires with run-flat characteristics)" ([▷ page 266](#)).

Vehicle with emergency spare wheel: in the event of a flat tire, the emergency spare wheel is mounted as described under "Mounting a wheel" ([▷ page 300](#)).

Rotating the wheels

WARNING

Interchanging the front and rear wheels may severely impair the driving characteristics if the wheels or tires have different dimensions. The wheel brakes or suspension components may also be damaged. There is a risk of accident.

Rotate front and rear wheels only if the wheels and tires are of the same dimensions.

! On vehicles equipped with a tire pressure monitor, electronic components are located in the wheel.

Tire-mounting tools should not be used near the valve. This could damage the electronic components.

Only have tires changed at a qualified specialist workshop.

Always observe the instructions and safety notes in the "Mounting a wheel" section (▷ page 300).

The wear patterns on the front and rear tires differ, depending on the operating conditions. Rotate the wheels before a clear wear pattern has formed on the tires. Front tires typically wear more on the shoulders and the rear tires in the center.

On vehicles that have the same size front and rear wheels, you can rotate the wheels according to the intervals in the tire manufacturer's warranty book in your vehicle documents. If no warranty book is available, the tires should be rotated every 3,000 to 6,000 miles (5,000 to 10,000 km). Depending on tire wear, this may be required earlier. Do not change the direction of wheel rotation.

Clean the contact surfaces of the wheel and the brake disc thoroughly every time a wheel is rotated. Check the tire pressure and reactivate the tire pressure monitor if necessary (▷ page 289).

Direction of rotation

Tires with a specified direction of rotation have additional benefits, e.g. if there is a risk of hydroplaning. These advantages can only be gained if the tires are installed corresponding to the direction of rotation.

An arrow on the sidewall of the tire indicates its correct direction of rotation.

Storing wheels

Store wheels that are not being used in a cool, dry and preferably dark place. Protect the tires from oil, grease, gasoline and diesel.

Mounting a wheel

Preparing the vehicle

- ▶ Stop the vehicle on solid, non-slippery and level ground.
- ▶ Apply the parking brake.
- ▶ Bring the front wheels into the straight-ahead position.
- ▶ Shift the transmission to position **P**.
- ▶ Switch off the engine.
- ▶ Remove the SmartKey from the ignition lock. or, on vehicles with KEYLESS-GO:
- ▶ Open the driver's door. The on-board electronics now have status **0**. This is the same as the SmartKey having been removed.
- ▶ Remove the Start/Stop button from the ignition lock (▷ page 122).
- ▶ If included in the vehicle equipment, remove the tire-change tool kit from the vehicle (▷ page 266).
- ▶ Safeguard the vehicle against rolling away.

Securing the vehicle to prevent it from rolling away

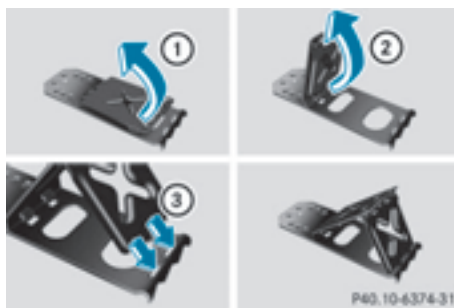

If your vehicle is equipped with a wheel chock, it can be found in the tire-change tool kit (▷ page 266).

The folding wheel chock is an additional safety measure to prevent the vehicle from rolling away, for example when changing a wheel.

- ▶ Fold both plates upwards ①.
- ▶ Fold out lower plate ②.
- ▶ Guide the lugs on the lower plate fully into the openings in base plate ③.



- ▶ Place chocks or other suitable items under the front and rear of the wheel that is diagonally opposite the wheel you wish to change.

Raising the vehicle

WARNING

If you do not position the jack correctly at the appropriate jacking point of the vehicle, the jack could tip over with the vehicle raised. There is a risk of injury.

Only position the jack at the appropriate jacking point of the vehicle. The base of the jack must be positioned vertically, directly under the jacking point of the vehicle.

- ❗ The jack is designed exclusively for jacking up the vehicle at the jacking points. Otherwise, your vehicle could be damaged.

Observe the following when raising the vehicle:

- To raise the vehicle, only use the vehicle-specific jack that has been tested and approved by Mercedes-Benz. If used incorrectly, the jack could tip over with the vehicle raised.
- The jack is designed only to raise and hold the vehicle for a short time while a wheel is being changed. It must not be used for performing maintenance work under the vehicle.
- Avoid changing the wheel on uphill and downhill slopes.
- Before raising the vehicle, secure it from rolling away by applying the parking brake and inserting wheel chocks. Do not disengage the parking brake while the vehicle is raised.
- The jack must be placed on a firm, flat and non-slip surface. On a loose surface, a large, flat, load-bearing underlay must be used. On a slippery surface, a non-slip underlay must be used, e.g. rubber mats.

- Do not use wooden blocks or similar objects as a jack underlay. Otherwise, the jack will not be able to achieve its load-bearing capacity due to the restricted height.
- Make sure that the distance between the underside of the tires and the ground does not exceed 1.2 in (3 cm).
- Never place your hands and feet under the raised vehicle.
- Do not lie under the vehicle.
- Do not start the engine when the vehicle is raised.
- Do not open or close a door or the trunk lid when the vehicle is raised.
- Make sure that no persons are present in the vehicle when the vehicle is raised.



- ▶ Using lug wrench ①, loosen the bolts on the wheel you wish to change by about one full turn. Do not unscrew the bolts completely.

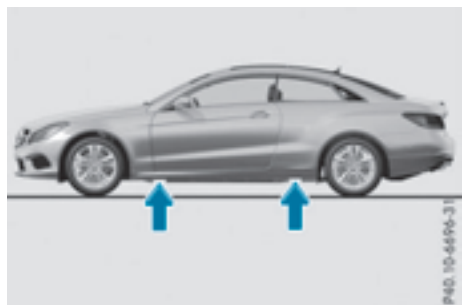

The jacking points are located just behind the front wheel housings and just in front of the rear wheel housings (arrows).

Vehicles with AMG equipment: to protect the vehicle body, the vehicle has covers next to the jacking points on the outer sills.

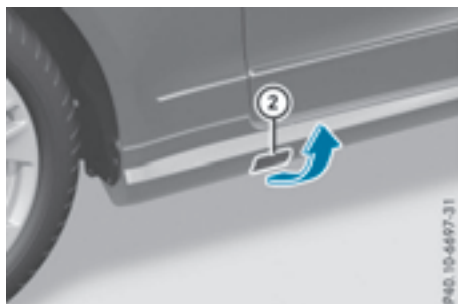

- ▶ **Vehicles with AMG equipment:** fold cover ② upwards.

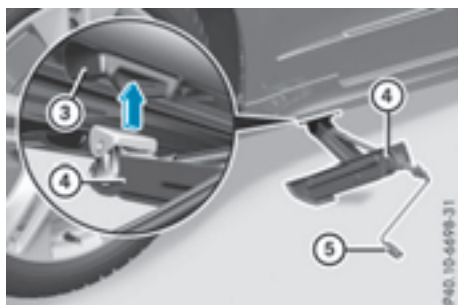

- ▶ Position jack ④ at jacking point ③.

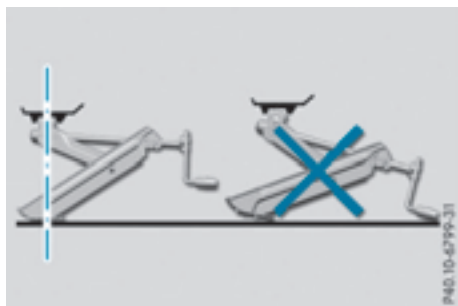

- ▶ Make sure the foot of the jack is directly beneath the jacking point.
- ▶ Turn crank ⑤ clockwise until jack ④ sits completely on jacking point ③. The base of the jack must lie evenly on the ground.
- ▶ Turn crank ⑤ until the tire is raised a maximum of 1.2 in (3 cm) from the ground.

Removing a wheel

- ⚠ Do not place wheel bolts in sand or on a dirty surface. The bolt and wheel hub threads could otherwise be damaged when you screw them in.



- ▶ Unscrew the uppermost wheel bolt completely.
- ▶ Screw alignment bolt ① into the thread instead of the wheel bolt.
- ▶ Unscrew the remaining wheel bolts fully.
- ▶ Remove the wheel.

Mounting a new wheel

⚠ WARNING

Oiled or greased wheel bolts or damaged wheel bolts/hub threads can cause the wheel bolts to come loose. As a result, you could lose a wheel while driving. There is a risk of accident.

Never oil or grease wheel bolts. In the event of damage to the threads, contact a qualified specialist workshop immediately. Have the damaged wheel bolts or hub threads replaced/renewed. Do not continue driving.

⚠ WARNING

If you tighten the wheel bolts or wheel nuts when the vehicle is raised, the jack could tip over. There is a risk of injury.

Only tighten the wheel bolts or wheel nuts when the vehicle is on the ground.

Always pay attention to the instructions and safety notes in the "Changing a wheel" section (> page 299).

Only use wheel bolts that have been designed for the wheel and the vehicle. For safety reasons, Mercedes-Benz recommends that you only use wheel bolts which have been approved for Mercedes-Benz vehicles and the respective wheel.

- ❗ To prevent damage to the paintwork, hold the wheel securely against the wheel hub while screwing in the first wheel bolt.

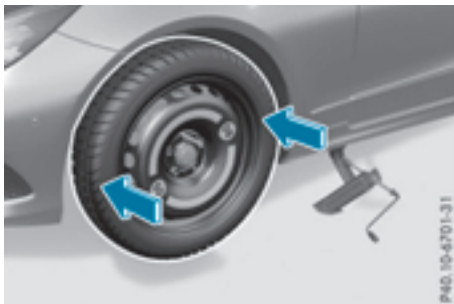

- ▶ Clean the wheel and wheel hub contact surfaces.
- ▶ Slide the wheel to be mounted onto the alignment bolt and push it on.
- ▶ Tighten the wheel bolts until they are finger-tight.
- ▶ Unscrew the alignment bolt.
- ▶ Tighten the last wheel bolt until it is finger-tight.

Lowering the vehicle

⚠ WARNING

The wheels could work loose if the wheel nuts and bolts are not tightened to the specified tightening torque. There is a risk of accident. Have the tightening torque immediately checked at a qualified specialist workshop after a wheel is changed.

- ▶ Turn the crank of the jack counter-clockwise until the vehicle is once again standing firmly on the ground.
- ▶ Place the jack to one side.

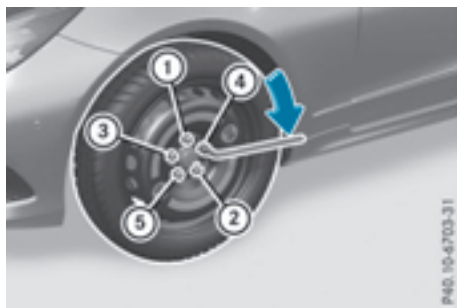

- ▶ Tighten the wheel bolts evenly in a crosswise pattern in the sequence indicated (① to ⑤). The specified tightening torque is **96 lb-ft (130 Nm)**.
- ▶ Turn the jack back to its initial position.
- ▶ Stow the jack and the rest of the vehicle tools in the trunk again.
- ▶ **Vehicles with AMG equipment:** insert the cover into the outer sill.
- ▶ Check the tire pressure of the newly mounted wheel and adjust it if necessary. Observe the recommended tire pressure (▷ page 284).

All wheels mounted must be equipped with functioning sensors.

Wheel and tire combinations

You can ask for information regarding permitted wheel-tire combinations at an authorized Mercedes-Benz Center.

- ❗ For safety reasons, Mercedes-Benz recommends that you only use tires and wheels which have been approved by Mercedes-Benz specifically for your vehicle.

These tires have been specially adapted for use with the control systems, such as ABS or ESP®, and are marked as follows:

- MO = Mercedes-Benz Original
- MOE = Mercedes-Benz Original Extended (tires featuring run-flat characteristics)
- MO1 = Mercedes-Benz Original (only certain AMG tires)

Mercedes-Benz Original Extended tires may only be used on wheels that have been specifically approved by Mercedes-Benz.

Only use tires, wheels or accessories tested and approved by Mercedes-Benz. Certain characteristics, e.g. handling, vehicle noise emissions or fuel consumption, may otherwise be adversely affected. In addition, when driving with a load, tire dimension variations could cause the tires to come into contact with the bodywork and axle components. This could result in damage to the tires or the vehicle.

Mercedes-Benz accepts no liability for damage resulting from the use of tires, wheels or accessories other than those tested and approved.

Information on tires, wheels and approved combinations can be obtained from any qualified specialist workshop.

! Retreaded tires are neither tested nor recommended by Mercedes-Benz, since previous damage cannot always be detected on retreaded tires. As a result, Mercedes-Benz cannot guarantee vehicle safety if retreaded tires are mounted. Do not mount used tires if you have no information about their previous usage.

The recommended pressures for various operating conditions can be found:

- on the Tire and Loading Information placard on the B-pillar on the driver's side
- in the tire pressure table in the fuel filler flap

Observe the notes on recommended tire pressures under various operating conditions (> page 284).

Check tire pressures regularly, and only when the tires are cold. Comply with the maintenance recommendations of the tire manufacturer in the vehicle document wallet.

Notes on the vehicle equipment – always equip the vehicle with:

- with tires of the same size on a given axle (left and right)
- the same type of tires at a given time (summer tires, winter tires, MOExtended tires)

Exception: it is permissible to install a different type or make in the event of a flat tire.

Observe the "MOExtended tires (tires with run-flat characteristics)" section (> page 266).

Vehicles equipped with MOExtended tires are not equipped with a TIREFIT kit at the factory. It is therefore recommended that you additionally equip your vehicle with a TIREFIT kit if you mount tires that do not feature run-flat properties, e.g.

winter tires. A TIREFIT kit may be obtained from a qualified specialist workshop.

Emergency spare wheel

Important safety notes

WARNING

The wheel or tire size as well as the tire type of the spare wheel or emergency spare wheel and the wheel to be replaced may differ.

Mounting an emergency spare wheel may severely impair the driving characteristics.

There is a risk of an accident.

To avoid hazardous situations:

- adapt your driving style accordingly and drive carefully.
- never mount more than one spare wheel or emergency spare wheel that differs in size.
- only use a spare wheel or emergency spare wheel of a different size briefly.
- do not switch ESP[®] off.
- have a spare wheel or emergency spare wheel of a different size replaced at the nearest qualified specialist workshop. Observe that the wheel and tire dimensions as well as the tire type must be correct.

When using an emergency spare wheel or spare wheel of a different size, you must not exceed the maximum speed of 50 mph (80 km/h).

Snow chains must not be mounted on emergency spare wheels.

General notes

You can ask for information regarding permitted emergency spare wheels at an authorized Mercedes-Benz Center.

You should regularly check the pressure of the emergency spare wheel, particularly prior to long trips, and correct the pressure as necessary (> page 284). The value on the wheel is valid.

An emergency spare wheel may also be mounted against the direction of rotation. Observe the time restriction on use as well as the speed

limitation specified on the emergency spare wheel.

Replace the tires after six years at the latest, regardless of wear. This also applies to the emergency spare wheel.

- i** When you are driving with the emergency spare wheel mounted, the tire pressure monitor cannot function reliably. Only restart the tire pressure monitor when the defective wheel has been replaced with a new wheel.

If an emergency spare wheel is mounted, the system may continue to show the tire pressure of the wheel that has been removed for a few minutes. The value displayed for the mounted emergency spare wheel is not the same as the current tire pressure of the emergency spare wheel.

"Minispare" emergency spare wheel



- ① "Minispare" emergency spare wheel
- ② Vehicle tool kit tray
- ③ Stowage well

The "Minispare" emergency spare wheel can be found in the stowage well under the trunk floor.

- ▶ Lift the trunk floor upwards (▷ page 239).
- ▶ Remove vehicle tool kit tray ②.
- ▶ Turn stowage well ③ counter-clockwise and remove it.
- ▶ Remove "Minispare" emergency spare wheel ①.

Always observe the instructions and safety notes in the "Mounting a wheel" section (▷ page 300).

Information regarding technical data

i The data stated here specifically refers to a vehicle with standard equipment. Consult an authorized Mercedes-Benz Center for the data for all vehicle variants and trim levels.

Vehicle electronics

Installing two-way radios and mobile phones (RF transmitters)

⚠ WARNING

The electromagnetic radiation from modified or incorrectly retrofitted RF-transmitters can interfere with the vehicle electronics. This can compromise the operational safety of the vehicle. There is a risk of an accident.

You should have all work to electrical and electronic equipment carried out at a qualified specialist workshop.

⚠ WARNING

The electromagnetic radiation from incorrectly operated RF transmitters can interfere with the vehicle electronics, for example:

- if the RF transmitter is not connected with an exterior antenna
- the exterior antenna has been installed incorrectly or is not a low-reflection type

This can compromise the operational safety of the vehicle. There is a risk of an accident.

Have the low-reflection exterior antenna mounted at a qualified specialist workshop. When operating RF transmitters in the vehicle, always connect them with the low-reflection exterior antenna.

! The operating permit may be invalidated if the instructions for installation and use of RF transmitters are not observed.

In particular, the following conditions must be complied with:

- only approved wavebands may be used.
- compliance with the maximum permissible output in these wavebands is required.
- only approved antenna positions may be used.

Excessive levels of electromagnetic radiation may cause damage to your health and the health of others. Using an exterior antenna takes into account current scientific discussions relating to the possible health hazards that may result from electromagnetic fields.

The following antenna positions may be used if RF transmitters have been properly installed:

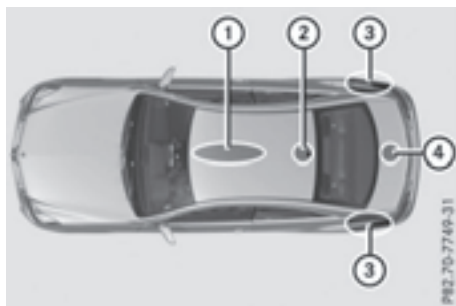

Approved antenna positions

- ① Front roof area
- ② Rear roof area
- ③ Rear fender
- ④ Trunk lid

i On vehicles with panorama roof with power tilt/sliding panel, installing an antenna to the front or rear roof area is not permitted.

On the rear fenders, it is recommended to position the antenna on the side of the vehicle closest to the center of the road.

Use the Technical Specification ISO/TS 21609 when retrofitting RF transmitters (Road Vehicles - EMC guidelines for installation of aftermarket radio frequency transmitting equipment).

Observe the legal requirements for retrofittings. If your vehicle has installations for two-way radio equipment, use the power supply or antenna connections intended for use with the basic wiring. Be sure to observe the manufacturer's additional instructions when installing.

Deviations with respect to wavebands, maximum transmission outputs or antenna positions must be approved by Mercedes-Benz.

The maximum transmission output (PEAK) at the base of the antenna must not exceed the values in the following table:

The maximum transmission output (PEAK) at the base of the antenna must not exceed the following values:

| Waveband | Maximum transmission output |
|--------------------------------------|-----------------------------|
| Short wave 3 - 54 MHz | 100 W |
| 4 m waveband 74 - 88 MHz | 30 W |
| 2 m waveband 144 - 174 MHz | 50 W |
| Trunked radio/Tetra 380 - 460 MHz | 10 W |
| 70 cm waveband 400 - 460 MHz | 35 W |
| Mobile communications (3G/3G/4G) | 10 W |

The following can be used in the vehicle without restrictions:

- RF transmitters with a maximum transmission output of up to 100 mW
- RF transmitters with transmitter frequencies in the 380 - 410 MHz waveband and a maximum transmission output of up to 2 W (trunked radio/Tetra)
- Mobile telephones (2G/3G/4G)

There is no restriction for antenna positions on the outside of the vehicle for the following wavebands:

- Trunked radio/Tetra
- 70 cm waveband
- 2G/3G/4G

Identification plates

Vehicle identification plate with vehicle identification number (VIN)



- Open the left door.
You will see vehicle identification plate ①.



Example: vehicle identification plate (USA only)

- ② VIN
- ③ Vehicle model



Example: vehicle identification plate (Canada only)

- ② VIN
- ③ Paint code

i The data shown on the vehicle identification plate is used only as an example. This data is different for every vehicle and can deviate

from the data shown here. You can find the data applicable to your vehicle on the vehicle identification plate.

Vehicle identification number (VIN)

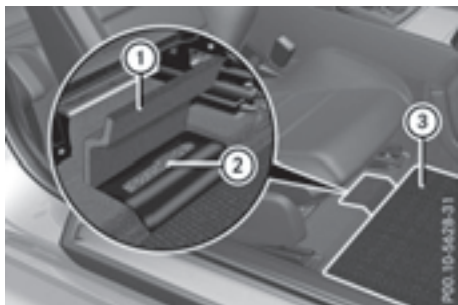

- ▶ Slide the right-hand front seat to its rearmost position.
- ▶ Slightly raise front floor covering ③ and fold floor covering flap ① upwards. You will see VIN ②.

Engine number

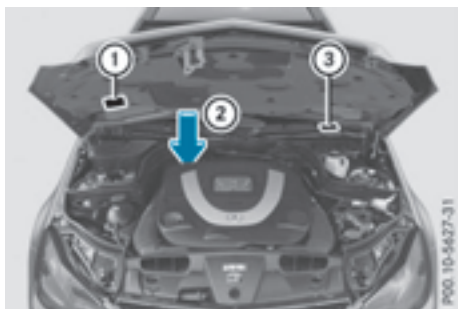

- ① Emission control information plate, including the certification of both federal and Californian emissions standards
- ② Engine number (stamped into the crankcase)
- ③ VIN (on the lower edge of the windshield)

Service products and filling capacities

Important safety notes

WARNING

Service products may be poisonous and hazardous to health. There is a risk of injury.

Comply with instructions on the use, storage and disposal of service products on the labels of the respective original containers. Always store service products sealed in their original containers. Always keep service products out of the reach of children.

Environmental note

Dispose of service products in an environmentally responsible manner.

Service products include the following:

- Fuels
- Lubricants (e.g. engine oil, transmission oil)
- Coolant
- Brake fluid
- Windshield washer fluid
- Climate control system refrigerant

Components and service products must be matched. Only use products recommended by Mercedes-Benz. Damage which is caused by the use of products which have not been recommended is not covered by the Mercedes-Benz warranty or goodwill gestures. They are listed in this Mercedes-Benz Operator's Manual in the appropriate section.

Information on tested and approved products can be obtained at an authorized Mercedes-Benz Center or on the Internet at <http://bevo.mercedes-benz.com>.

You can recognize service products approved by Mercedes-Benz by the following inscription on the containers:

- MB-Freigabe (e.g. MB-Freigabe 229.51)
- MB-Approval (e.g. MB-Approval 229.51)

Other designations or recommendations indicate a level of quality or a specification in accordance with an MB Sheet Number (e.g. MB 229.5). They have not necessarily been approved by Mercedes-Benz.

Other identifications, for example:

- 0 W-30
- 5 W-30
- 5 W-40

Fuel

Important safety notes

WARNING

Fuel is highly flammable. If you handle fuel incorrectly, there is a risk of fire and explosion.

You must avoid fire, open flames, creating sparks and smoking. Switch off the engine and, if applicable, the auxiliary heating before refueling.

WARNING

Fuel is poisonous and hazardous to health. There is a risk of injury.

You must make sure that fuel does not come into contact with your skin, eyes or clothing and that it is not swallowed. Do not inhale fuel vapors. Keep fuel away from children.

If you or others come into contact with fuel, observe the following:

- Wash away fuel from skin immediately using soap and water.
- If fuel comes into contact with your eyes, immediately rinse them thoroughly with clean water. Seek medical assistance without delay.
- If fuel is swallowed, seek medical assistance without delay. Do not induce vomiting.
- Immediately change out of clothing which has come into contact with fuel.

Tank capacity

| Model | Total capacity |
|------------|----------------------|
| All models | 17.4 US gal (66.0 l) |

| Model | Of which reserve |
|------------|----------------------------------|
| All models | Approx. 2.1 US gal (8.0 l) |

Gasoline

Fuel grade

 Do not use diesel to refuel vehicles with a gasoline engine. Do not switch on the ignition if you accidentally refuel with the wrong fuel. Otherwise, the fuel will enter the fuel system. Even small amounts of the wrong fuel could result in damage to the fuel system and the engine. Notify a qualified specialist workshop and have the fuel tank and fuel lines drained completely.

 Only refuel using unleaded premium grade gasoline with at least 91 AKI/95 RON.

 E10 fuel contains up to 10% bioethanol. Your vehicle is E10-compatible. You can refuel your vehicle using E10 fuel.

 Only use the fuel recommended. Operating the vehicle with other fuels can lead to engine failure.

 Do not use the following:

- E15 (gasoline with 15% ethanol)
- E85 (gasoline with 85% ethanol)
- E100 (100% ethanol)
- M15 (gasoline with 15% methanol)
- M30 (gasoline with 30% methanol)
- M85 (gasoline with 85% methanol)
- M100 (100% methanol)
- Gasoline with metalliferous additives
- Diesel

Do not mix such fuels with the fuel recommended for your vehicle.

 To ensure the longevity and full performance of the engine, only premium-grade unleaded gasoline must be used.

If standard unleaded gasoline is unavailable and you have to refuel with unleaded gasoline of a lower grade, observe the following precautions:

- Only fill the fuel tank to half full with regular unleaded gasoline and fill the rest with pre-

mium-grade unleaded gasoline as soon as possible.

- Do not drive at the maximum speed.
- Avoid sudden acceleration and engine speeds over 3,000 rpm.

You will usually find information about the fuel grade on the pump. If you cannot find the label on the pump, ask the staff for assistance.

i For further information, consult a qualified specialist workshop or visit <http://www.mbusa.com> (USA only).

As a temporary measure, if the recommended fuel is not available, you may also use regular unleaded gasoline with an octane rating of 87 AKI/91 RON. This may reduce engine performance and increase fuel consumption. Avoid driving at full throttle and sudden acceleration. Never refuel using fuel with a lower AKI.

Information on refueling (▷ page 136).

Additives

i In some countries, the available gasoline may not be sufficiently low in sulfur. This fuel can temporarily produce unpleasant odors, especially on short journeys. As soon as sulfur-free fuel (sulfur content < 10 ppm) is used for refueling, the odors are reduced.

Flexible Fuel vehicles

Important safety notes

WARNING

Fuel is highly flammable. If you handle fuel incorrectly, there is a risk of fire and explosion.

You must avoid fire, open flames, creating sparks and smoking. Switch off the engine and, if applicable, the auxiliary heating before refueling.

WARNING

Fuel is poisonous and hazardous to health. There is a risk of injury.

You must make sure that fuel does not come into contact with your skin, eyes or clothing and that it is not swallowed. Do not inhale fuel vapors. Keep fuel away from children.

If you or others come into contact with fuel, observe the following:

- Wash away fuel from skin immediately using soap and water.
- If fuel comes into contact with your eyes, immediately rinse them thoroughly with clean water. Seek medical assistance without delay.
- If fuel is swallowed, seek medical assistance without delay. Do not induce vomiting.
- Immediately change out of clothing which has come into contact with fuel.

Flexible Fuel vehicles can be refueled with the following fuel types:

- premium-grade unleaded gasoline
- E85 fuel
- a mixture of E85 fuel and premium-grade unleaded gasoline

i Flexible Fuel vehicles can be recognized by the **Ethanol up to E85** sticker on the inside of the fuel filler flap.

Fuel consumption

The energy content of E85 fuel is less than that of the same amount of premium-grade gasoline. The amount of fuel consumed when operating the vehicle with E85 fuel is therefore higher than with premium-grade gasoline.

Maintenance

Inform your authorized Mercedes-Benz Center that you are operating or have operated the vehicle with E85 fuel.

Low outside temperatures

If the outside temperature is below 32 °F (0 °C), the starting procedure can take noticeably longer when operating with E85 fuel.

E85 fuel is not suitable for use at outside temperatures under -4 °F (-20 °C).

Engine oil

General notes



! Never use engine oil or an oil filter of a specification other than is necessary to fulfill the prescribed service intervals. Do not change the engine oil or oil filter in order to achieve longer replacement intervals than those prescribed. You could otherwise cause engine damage or damage to the exhaust gas after-treatment.

Follow the instructions in the service interval display regarding the oil change. Otherwise, you may damage the engine and the exhaust gas aftertreatment.

When handling engine oil, observe the important safety notes on service products (▷ page 308). The engine oils are matched to the performance of Mercedes-Benz engines and service intervals. You should therefore only use engine oils and oil filters that are approved for vehicles with maintenance systems.

For a list of approved engine oils and oil filters, consult an authorized Mercedes-Benz Center. Or visit the website <http://bevo.mercedes-benz.com>.

The table shows which engine oils have been approved for your vehicle.

| Model | MB-Freigabe or MB-Approval |
|------------|----------------------------|
| All models | 229.5 |

i MB approval is indicated on the oil containers.

Filling capacities

The following values refer to an oil change including the oil filter.

| Model | Capacity |
|--------------|-------------------|
| E 400 | 6.9 US qt (6.5 l) |
| E 400 4MATIC | |
| E 550 | 8.5 US qt (8.0 l) |

Additives

! Do not use any additives in the engine oil. This could damage the engine.

Brake fluid

⚠ WARNING

The brake fluid constantly absorbs moisture from the air. This lowers the boiling point of the brake fluid. If the boiling point of the brake fluid is too low, vapor pockets may form in the brake system when the brakes are applied hard. This would impair braking efficiency. There is a risk of an accident.

You should have the brake fluid renewed at the specified intervals.

Comply with the important safety notes for service products when handling brake fluid (▷ page 308).

The brake fluid change intervals can be found in the Maintenance Booklet.

Only use brake fluid approved by Mercedes-Benz in accordance with MB-Freigabe or MB-Approval 331.0.

Information about approved brake fluid can be obtained at any qualified specialist workshop or on the Internet at <http://bevo.mercedes-benz.com>.

i Have the brake fluid regularly replaced at a qualified specialist workshop and the replacement confirmed in the Maintenance Booklet.

Coolant

Important safety notes

 **WARNING**

If antifreeze comes into contact with hot components in the engine compartment, it may ignite. There is a risk of fire and injury.

Let the engine cool down before you add antifreeze. Make sure that antifreeze is not spilled next to the filler neck. Thoroughly clean the antifreeze from components before starting the engine.

-  Only add coolant that has been premixed with the desired antifreeze protection. You could otherwise damage the engine. Further information on coolants can be found in the Mercedes-Benz Specifications for Service Products, MB BeVo 310.1, e.g. on the Internet at <http://bevo.mercedes-benz.com>. Or contact a qualified specialist workshop.

-  Always use a suitable coolant mixture, even in countries where high temperatures prevail. Otherwise, the engine cooling system is not sufficiently protected from corrosion and overheating.

-  Have the coolant regularly replaced at a qualified specialist workshop and the replacement confirmed in the Maintenance Booklet.

Comply with the important safety precautions for service products when handling coolant (> page 308).

The coolant is a mixture of water and antifreeze/corrosion inhibitor. It performs the following tasks:



- corrosion protection
- antifreeze protection
- raising the boiling point

If the coolant has antifreeze protection down to -35 °F (-37 °C), the boiling point of the coolant during operation is approximately 266 °F (130 °C).

The antifreeze concentrate/corrosion inhibitor concentration in the engine cooling system should:

- be at least 50%. This will protect the engine cooling system against freezing down to approximately -35 °F (-37 °C).
- not exceed 55% (antifreeze protection down to -49 °F [-45 °C]). Otherwise, heat will not be dissipated as effectively.

Mercedes-Benz recommends an antifreeze/corrosion inhibitor concentrate in accordance with MB Specifications for Service Products 310.1.

-  When the vehicle is first delivered, it is filled with a coolant mixture that ensures adequate antifreeze and corrosion protection.
-  The coolant is checked with every maintenance interval at a qualified specialist workshop.

Filling capacities

| Model | Capacity |
|-------------------------|-----------------------------|
| E 550 | Approx. 11.5 US qt (10.9 l) |
| All other models | Approx. 10.9 US qt (10.3 l) |

Windshield washer system

Important safety notes

 **WARNING**

Windshield washer concentrate could ignite if it comes into contact with hot engine components or the exhaust system. There is a risk of fire and injury.

Make sure that no windshield washer concentrate is spilled next to the filler neck.

-  Only MB SummerFit and MB WinterFit washer fluid should be mixed together. The spray nozzles may otherwise become blocked.

Do not use distilled or de-ionised water, otherwise, the level sensor may give a false reading.

When handling washer fluid, observe the important safety notes on service products (▷ page 308).

At temperatures above freezing:

- ▶ Fill the washer fluid reservoir with a mixture of water and windshield washer fluid, e.g. MB SummerFit.

Add 1 part MB SummerFit to 100 parts water.

At temperatures below freezing:

- ▶ Fill the washer fluid reservoir with a mixture of water and washer fluid, e.g. MB WinterFit.

For the correct mixing ratio refer to the information on the antifreeze reservoir.

- i** Add windshield washer fluid, e.g. MB SummerFit or MB WinterFit, to the washer fluid all year round.

Climate control system refrigerant

Important safety notes

The climate control system of your vehicle is filled with refrigerant R-134a.

The instruction label regarding the refrigerant type used can be found on the radiator cross member.

- !** Only the refrigerant R-134a and the PAG oil approved by Mercedes-Benz may be used. The approved PAG oil may not be mixed with any other PAG oil that is not approved for R-134a refrigerant. Otherwise, the climate control system may be damaged.

Service work, such as topping up refrigerant or replacing components, may only be carried out by a qualified specialist workshop. All applicable regulations must be adhered to, SAE standard J639 included.

Always have work on the climate control system carried out at a qualified specialist workshop.

Refrigerant instruction label



Example: refrigerant instruction label

- ① Warning symbol
- ② Refrigerant filling capacity
- ③ Applicable standards
- ④ PAG oil part number
- ⑤ Type of refrigerant

Warning symbol ① advises you about:

- possible dangers
- having service work carried out at a qualified specialist workshop

Filling capacities

| All models | Capacity |
|--------------------|-------------------------------|
| Refrigerant | 20.8 ± 0.4 oz (590 ± 10 g) |
| PAG oil | 4.2 ± 0.4 oz (120 ± 10 g) |

Vehicle data

General notes

Please note that for the specified vehicle data:

- the heights specified may vary as a result of:
 - tires
 - load
 - condition of the suspension
 - optional equipment
- optional equipment reduces the maximum payload.

Dimensions and weights



| Model | ① Opening height |
|--------------|----------------------|
| E 400 | 66.2 in (1682 mm) |
| E 400 4MATIC | 66.2 in (1682 mm) |
| E 550 | 66.1 in (1680 mm) |

| All models | |
|--|--------------------|
| Vehicle width including exterior mirrors | 79.4 in (2016 mm) |
| Vehicle height | 55.0 in (1397 mm) |
| Wheelbase | 108.7 in (2760 mm) |
| Maximum roof load | 220 lb (100 kg) |
| Maximum trunk load | 220 lb (100 kg) |

| Model | Vehicle length |
|------------------|--------------------|
| E 550 | 186.9 in (4746 mm) |
| All other models | 185.2 in (4703 mm) |

| Model | Turning radius |
|--------------|-------------------|
| E 400 | 36.6 ft (11.15 m) |
| E 400 4MATIC | 37.0 ft (11.27 m) |
| E 550 | 36.7 ft (11.19 m) |

