



### Digital – in the vehicle

Familiarize yourself with the contents of the Operator's Manual directly via the vehicle's multimedia system (menu item "Vehicle information"). Start with the quick guide or broaden your knowledge with practical tips.



### Vehicle document wallet

Here you can find comprehensive information about operating your vehicle and about services and guarantees in printed form.



### Digital – on the Internet

You can find the Operator's Manual on the Mercedes-Benz homepage.



### Digital – as an app

The Mercedes-Benz Guides app is available free-of-charge in familiar app stores.



1675847413

Order no. P167 0257 13 Part no. 167 584 74 13  
Edition B 2021



Apple® iOS



Android™

GLE Coupe

Mercedes-Benz



## GLE Coupe

Operator's Manual

Mercedes-Benz



## Front passenger airbag warning

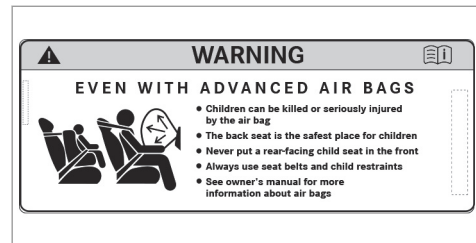

Example

**⚠ WARNING** Risk of injury or fatal injuries if the front passenger airbag is enabled

If the front passenger airbag is enabled, a child on the front passenger seat may be struck by the front passenger airbag during an accident.

NEVER use a rearward facing child restraint system on a seat protected by an ENABLED FRONT AIRBAG in front of it, this can result in DEATH or SERIOUS INJURY to the child.

Observe the chapter "Children in the vehicle".

## Publication details

### Internet

Further information about Mercedes-Benz vehicles and about Mercedes-Benz AG can be found on the following websites:

<https://www.mbusa.com> (USA only)

<https://www.mercedes-benz.ca> (Canada only)

### Documentation team

©Mercedes-Benz AG: Not to be reprinted, translated or otherwise reproduced, in whole or in part, without written permission from Mercedes-Benz AG.

### Vehicle manufacturer

Mercedes-Benz AG

Mercedesstraße 120

70372 Stuttgart

Germany

As at ohne



## Thank you for purchasing a Mercedes-Benz

Before you first drive off, read this Operator's Manual carefully and familiarize yourself with your vehicle. For your own safety and a longer operating lifespan of the vehicle, follow the instructions and warning notices in this Operator's Manual. Disregarding them may lead to damage to the vehicle or injury to people.

Damage to the vehicle resulting from the disregard of the instructions is not covered by the Mercedes-Benz Limited Warranty.

The standard equipment and product description of your vehicle may vary and depends on the following factors:

- Model
- Order
- National version
- Availability

Mercedes-Benz reserves the right to introduce changes in the following areas:

- Design
- Equipment

- Technical features

The equipment in your vehicle may therefore differ from that shown in the descriptions and illustrations.

The following documents are integral parts of the vehicle:

- Digital Operator's Manual
- Printed Operator's Manual
- Maintenance Booklet
- Equipment-dependent Supplements

Keep these documents in the vehicle at all times. If you sell the vehicle, always pass all of the documents on to the new owner.

Mercedes-Benz USA, LLC  
Mercedes-Benz Canada, Inc.  
A Daimler Company

1675847413



<b>Symbols</b> .....	5	Qualified specialist workshop .....	28	Doors .....	68
<b>At a glance</b> .....	6	Correct use of the vehicle .....	28	Cargo compartment .....	72
Cockpit .....	6	Sport Utility Vehicle .....	29	Side windows .....	77
Indicator and warning lamps .....	10	Notes for persons with electronic medi- cal aids .....	29	Sliding sunroof .....	80
Overhead control panel .....	12	Problems with your vehicle .....	29	Anti-theft protection .....	84
Door control panel and seat adjustment .....	14	Reporting safety defects .....	30	<b>Seats and stowing</b> .....	<b>88</b>
Control settings in the rear passenger compartment .....	16	Limited Warranty .....	31	Notes on the correct driver's seat posi- tion .....	88
Emergencies and breakdowns .....	18	QR code for rescue card .....	31	Seats .....	88
<b>Digital Operator's Manual</b> .....	<b>20</b>	Data storage .....	31	Steering wheel .....	98
Calling up the Digital Operator's Manual .....	20	Copyright .....	34	Easy entry and exit feature .....	99
<b>General notes</b> .....	<b>22</b>	<b>Occupant safety</b> .....	<b>36</b>	Operating the memory function .....	101
Protecting the environment .....	22	Restraint system .....	36	Stowage areas .....	102
Mercedes-Benz GenuineParts .....	23	Seat belts .....	38	Cup holder .....	114
Operator's Manual .....	23	Airbags .....	42	Sockets .....	115
Service and vehicle operation .....	24	PRE-SAFE® system .....	49	Wireless charging of the mobile phone and connection with the exterior antenna ...	118
Operating safety .....	25	Automatic measures after an accident .....	50	Installing/removing the floor mats .....	119
Declaration of conformity for wireless vehicle components .....	27	Safely transporting children in the vehi- cle .....	51	<b>Light and visibility</b> .....	<b>121</b>
Diagnostics connection .....	27	Notes on pets in the vehicle .....	64	Exterior lighting .....	121
		<b>Opening and closing</b> .....	<b>65</b>	Interior lighting .....	126
		SmartKey .....	65		

Windshield wiper and windshield washer system .....	128				
Mirrors .....	131				
Area permeable to radio waves on the windshield .....	134				
Infrared-reflective windshield function .....	134				
<b>Climate control</b> .....	<b>135</b>				
Overview of climate control systems .....	135				
Operating the climate control system .....	136				
<b>Driving and parking</b> .....	<b>143</b>				
Driving .....	143				
DYNAMIC SELECT switch .....	157				
Automatic transmission .....	160				
Function of the 4MATIC .....	164				
Refueling .....	164				
Parking .....	167				
Driving and driving safety systems .....	174				
Trailer hitch .....	236				
Vehicle towing instructions .....	240				
<b>Instrument Display and on-board computer</b> .....	<b>241</b>				
Notes on the Instrument Display and on-board computer .....	241				
Instrument Display overview .....	242				
Overview of the buttons on the steering wheel .....	243				
Operating the on-board computer .....	243				
Overview of what is shown on the multi-function display .....	245				
Head-up Display .....	245				
<b>MBUX multimedia system</b> .....	<b>248</b>				
Overview and operation .....	248				
System settings .....	256				
Navigation .....	259				
Telephone .....	266				
Mercedes me and apps .....	269				
Mercedes-Benz emergency call system .....	276				
Radio & media .....	280				
Sound settings .....	287				
<b>Maintenance and care</b> .....	<b>288</b>				
ASSYST PLUS service interval display .....	288				
Engine compartment .....	289				
Cleaning and care .....	295				
<b>Breakdown assistance</b> .....	<b>303</b>				
Flat tire .....	303				
Battery (vehicle) .....	307				
Tow starting or towing away .....	313				
Electrical fuses .....	317				
<b>Wheels and tires</b> .....	<b>320</b>				
Notes on noise or unusual handling characteristics .....	320				
Notes on regularly inspecting wheels and tires .....	320				
Notes on snow chains .....	321				
Tire pressure .....	321				
Loading the vehicle .....	326				
Tire labeling .....	331				
Definition of terms for tires and loading .....	336				
Changing a wheel .....	339				
Emergency spare wheel .....	348				
Collapsible spare wheel .....	350				

## 4 Contents

---

<b>Technical data</b> .....	<b>353</b>
Notes on technical data .....	353
Vehicle electronics .....	353
Radio equipment approvals for the vehicle components .....	355
Vehicle identification plate, VIN and engine number overview .....	355
Operating fluids .....	357
Vehicle data .....	363
Trailer hitch .....	366
<hr/>	
<b>Display messages and warning/indicator lamps</b> .....	<b>368</b>
Display messages .....	368
Warning and indicator lamps .....	417
<hr/>	
<b>Index</b> .....	<b>431</b>

In this Operator's Manual, you will find the following symbols:

**⚠ DANGER** Danger due to not observing the warning notices

Warning notices draw your attention to hazards that may endanger your health or life, or the health or life of others.

▶ Observe the warning notices.

**🌿 ENVIRONMENTAL NOTE** Environmental damage due to failure to observe environmental notes

Environmental notes include information on environmentally responsible behavior or environmentally responsible disposal.

▶ Observe environmental notes.

**! NOTE** Damage to property due to failure to observe notes on material damage

Notes on material damage inform you of risks which may lead to your vehicle being damaged.

▶ Observe notes on material damage.

ⓘ These symbols indicate useful instructions or further information that could be helpful to you.

▶ Instruction

(→ page) Further information on a topic

Display Information on the multifunction display/media display

↗▶ Highest menu level, which is to be selected in the multimedia system

▶▶ Relevant submenus, which are to be selected in the multimedia system

\* Indicates a cause



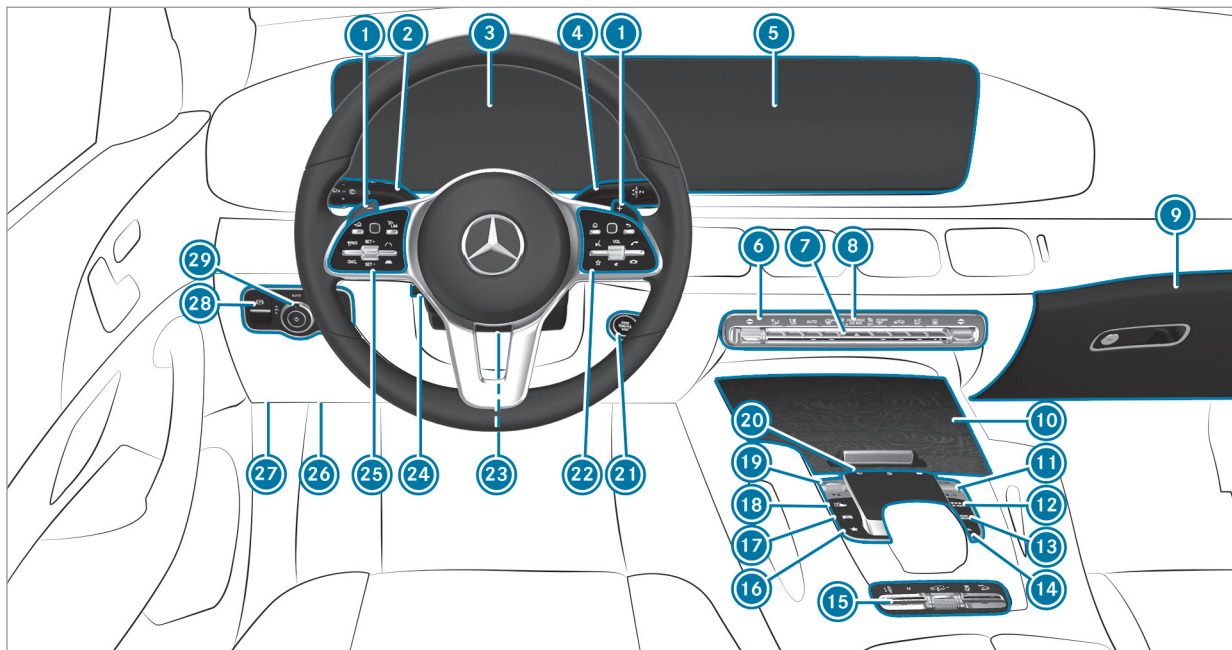

Left-hand-drive vehicles

① Steering wheel gearshift paddles	→	162	⑮ Control panel for:		
② Combination switch	→	122	Individual wheel control	→	209
③ Instrument Display	→	242	Manual gearshifting	→	162
④ DIRECT SELECT lever	→	160	AIRMATIC or	→	201
⑤ Media display	→	248	E-ACTIVE BODY CONTROL	→	206
⑥ Climate control systems	→	136	Activates/deactivates ESP®	→	176
⑦ Hazard warning light system	→	123	Downhill Speed Regulation	→	186
⑧ PASSENGER AIR BAG indicator lamps	→	46	⑯ Calls up favorites	→	250
⑨ Glove box	→	104	⑰ Calls up vehicle functions	→	250
⑩ Storage compartment	→	104	⑱ Active Parking Assist	→	224
⑪ Controller for volume and switching sound on/off	→	248	⑲ DYNAMIC SELECT switch	→	158
Switches the MBUX multimedia system on/off	→	248	⑳ Touchpad	→	250
⑫ Calls up navigation	→	250	㉑ Start/stop button	→	144
⑬ Calls up radio or media	→	250	ECO start/stop function	→	155
⑭ Calls up the telephone	→	250	㉒ Control panel for the MBUX multimedia system	→	243
			㉓ Adjusts the steering wheel mechanically	→	98

## 8 At a glance – Cockpit

---

24	Adjusts the steering wheel electrically	→	98	Active Distance Assist DISTRONIC	→	191	
	Switches the steering wheel heater on/off	→	99	26	Diagnostics connection	→	27
25	Control panel:			27	Opens the hood	→	289
	On-board computer	→	243	28	Electric parking brake	→	170
	Cruise control	→	185	29	Light switch	→	121





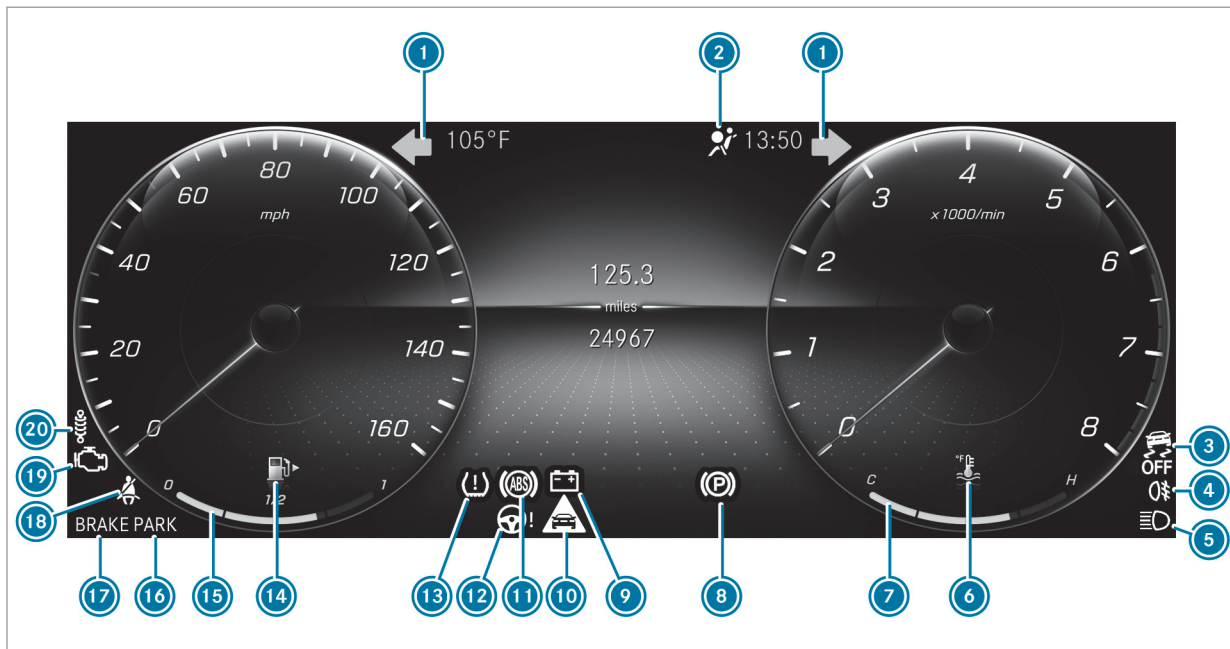





















## 10 At a glance – Indicator and warning lamps



Instrument Display









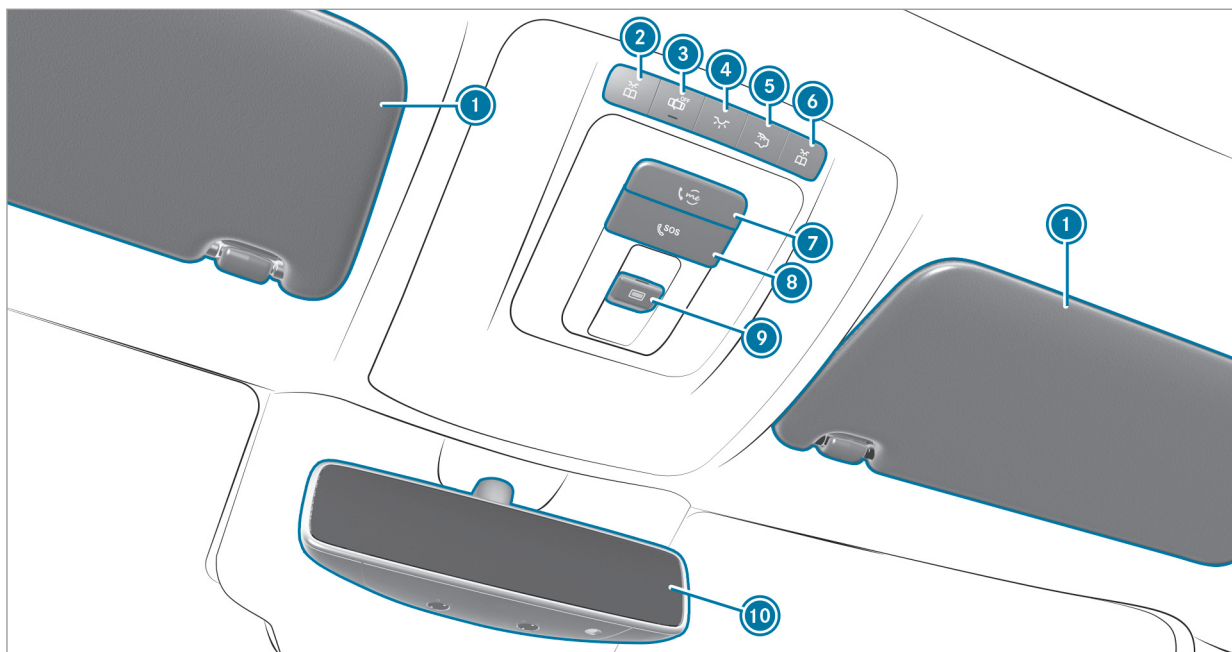

1		Turn signal light	→	122
2		Restraint system	→	419
3		ESP® OFF	→	427
		ESP®	→	427
4		Rear fog lamp	→	122
5		High beam	→	122
		Low beam	→	121
		Parking lamps	→	121
6		Coolant temperature	→	421
7		Coolant temperature display	→	242
8		Electric parking brake (yellow)	→	424
9		Electrical malfunction	→	421
10		Distance warning	→	426
11		ABS	→	427
12		Electric power steering	→	420

13		Tire pressure monitor	→	429
14		Reserve fuel with fuel filler flap location indicator	→	421
15		Fuel level	→	242
16		Electric parking brake (red)	→	424
		USA only		
		Canada only		
17		Brakes (red)	→	424
		USA only		
		Canada only		
18		Seat belt	→	419
19		Check Engine	→	421
20		Suspension (red)	→	426
		Suspension (yellow)	→	426

12 At a glance – Overhead control panel



① Sun visors			
②  Switches the left-hand reading lamp on/off	→	126	
③  Switches automatic interior lighting control on/off	→	126	
④  Switches the front interior lighting on/off	→	126	
⑤  Switches the rear interior lighting on/off	→	126	
⑥  Switches the right-hand reading lamp on/off	→	126	
⑦  me button	→	271	
⑧  SOS button	→	271	
⑨  Opens closes the panorama roof with power tilt/sliding panel	→	80	
 Opens/closes the roller sunblind	→	80	
⑩ Inside rearview mirror	→	132	

14 At a glance – Door control panel and seat adjustment

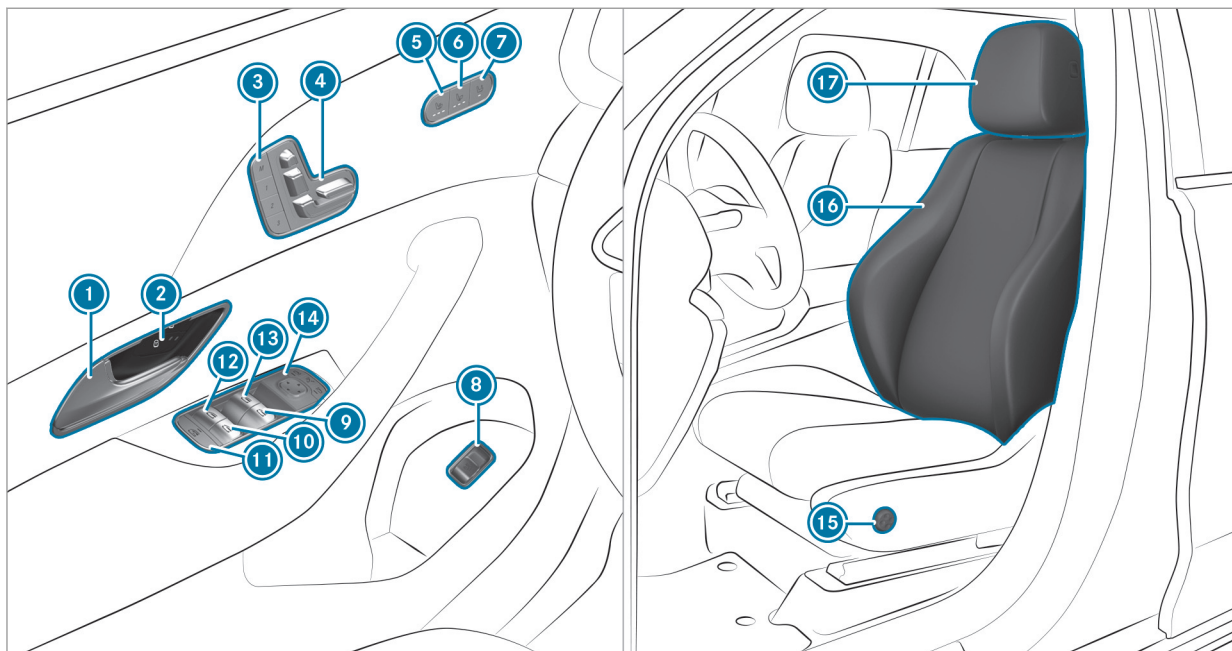

①	Opens the door	→	68	⑩	Opens/closes the rear right side window	→	77
②	Locks/unlocks the vehicle	→	69	⑪	Child safety lock for the rear side windows	→	64
③	Sets the memory function	→	101	⑫	Opens/closes the rear left side window	→	77
④	Adjusts the seats electrically	→	88	⑬	Opens/closes the left side window	→	77
⑤	Switches the seat heating on/off	→	96	⑭	Operates the outside mirrors	→	131
⑥	Switches the seat ventilation on/off	→	97	⑮	Adjusts the 4-way lumbar support	→	91
⑦	Adjusts the front passenger seat from the driver's seat	→	90	⑯	Seat adjustment using the multimedia system	→	93
⑧	Opens/closes the tailgate	→	72	⑰	Adjusts the head restraints	→	91
⑨	Opens/closes the right side window	→	77				



16 At a glance – Control settings in the rear passenger compartment

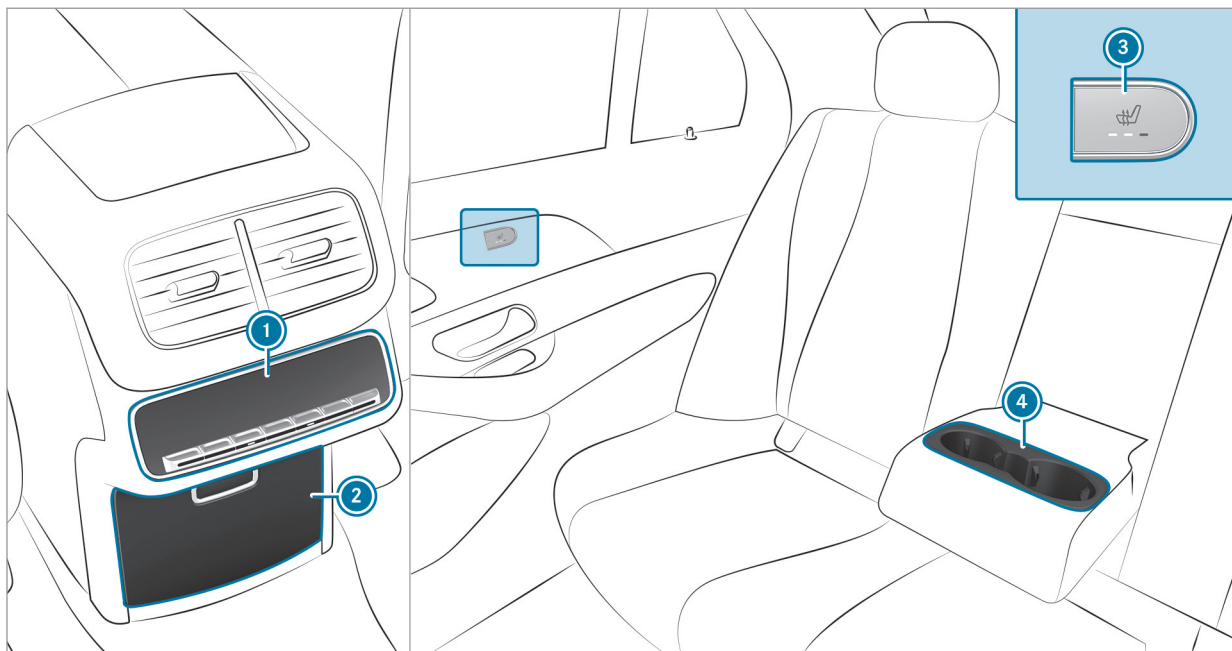

① Control panel for rear compartment climate control → 136

---

② Storage compartment in the center console  
115 V socket → 116

---

③ Switches the rear seat heating on/off → 96

---

④ Cup holder

---

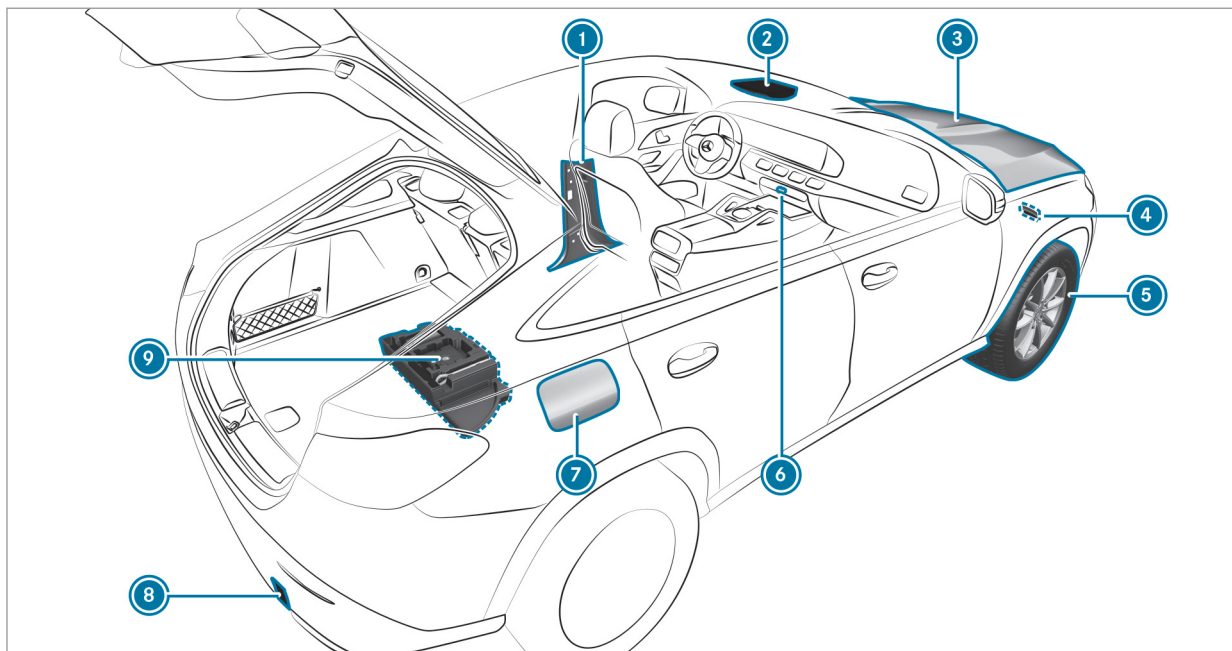

① QR code for accessing the rescue card	→	31	⑥ Hazard warning lamps	→	123
② me button and SOS button	→	271	⑦ Fuel filler flap with instruction labels for tire pressure, fuel type and QR code for accessing the rescue card	→	164
③ Checking and adding operating fluids	→	357	⑧ Tow-starting and towing away	→	314
Starting assistance	→	311	⑨ TIREFIT kit	→	303
④ Tow-starting and towing away	→	314			
⑤ Flat tire	→	303			

### Calling up the Digital Operator's Manual

Multimedia system:

→  » Info » Operator's Manual  
» 



The Digital Operator's Manual describes the functions and operation of the vehicle and the multimedia system.

► Select one of the following menu items in the Digital Operator's Manual:

- **Search:** search for keywords in order to find quick answers to questions about the operation of the vehicle.

- **Quick start:** find the first steps towards setting up your vehicle.
- **Tips:** find information that prepares you for certain everyday situations with your vehicle.
- **Animations:** watch animations of the vehicle functions.
- **Messages:** receive additional information about the messages in the instrument display.
- **Bookmarks:** gain access to your personally saved bookmarks.
- **Language:** select the language for the Digital Operator's Manual.

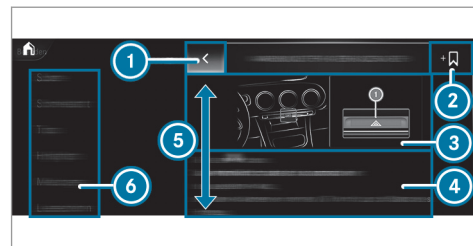

- 1 Back
- 2 Adds bookmarks
- 3 Picture
- 4 Contents section
- 5 Directions of movement of contents section
- 6 Menu

Some sections in the Digital Operator's Manual, e.g. warning notes, can be expanded and collapsed.

### Additional methods of calling up the Digital Operator's Manual:

**Direct access:** open the required content in the Digital Operator's Manual by pressing and hold-



ing an entry on the tab bar in the multimedia system:

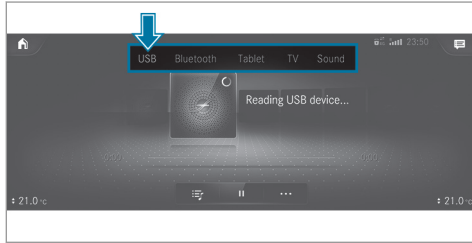

**Instrument Display:** call up brief information as display messages in the instrument cluster

**Voice Control System:** call up via the voice control system

For safety reasons, the Digital Operator's Manual is deactivated while driving.

### Protecting the environment

 **ENVIRONMENTAL NOTE** Environmental damage due to operating conditions and personal driving style

The pollutant emission of the vehicle is directly related to the way you operate the vehicle.

Operate your vehicle in an environmentally responsible manner to help protect the environment. Please observe the following recommendations on operating conditions and personal driving style.

#### Operating conditions:

- ▶ Make sure that the tire pressure is correct.
- ▶ Do not carry any unnecessary weight (e.g. roof luggage racks once you no longer need them).
- ▶ Adhere to the service intervals. A regularly serviced vehicle will contribute to environmental protection.

- ▶ Always have maintenance work carried out at a qualified specialist workshop.

#### Personal driving style:

- ▶ Do not depress the accelerator pedal when starting the engine.
- ▶ Do not warm up the engine while the vehicle is stationary.
- ▶ Drive carefully and maintain a suitable distance from the vehicle in front.
- ▶ Avoid frequent, sudden acceleration and braking.
- ▶ Change gear in good time and use each gear only up to  $\frac{2}{3}$  of its maximum engine speed.
- ▶ Switch off the engine in stationary traffic, e.g. by using the ECO start/stop function.
- ▶ Drive fuel-efficiently. Observe the ECO display for a fuel-efficient driving style.

 **ENVIRONMENTAL NOTE** Environmental pollution caused by irresponsible disposal of the high-voltage battery

A high-voltage battery contains materials which are harmful to the environment.

- ▶ Dispose of defective high-voltage batteries at a qualified specialist workshop.

#### Environmental issues and recommendations:

It is recommended that you re-use or recycle materials instead of just disposing of them.

The relevant environmental guidelines and regulations serve to protect the environment and must be strictly observed.

## Mercedes-Benz GenuineParts

 **ENVIRONMENTAL NOTE** Environmental damage caused by not using recycled reconditioned components

Mercedes-Benz AG offers recycled reconditioned components and parts with the same quality as new parts. The same entitlement from the Limited Warranty is valid as for new parts.

- ▶ Recycled reconditioned components and parts from Mercedes-Benz AG.

 **NOTE** Impairment of the operating efficiency of the restraint systems from installing accessory parts or from repairs or welding

Airbags and Emergency Tensioning Devices, as well as control units and sensors for the restraint systems, may be installed in the following areas of your vehicle:

- Doors

- Door pillars
  - Door sills
  - Seats
  - Cockpit
  - Instrument cluster
  - Center console
  - Lateral roof frame
- ▶ Do not install accessory parts such as audio systems in these areas.
  - ▶ Do not carry out repairs or welding.
  - ▶ Have aftermarket installation of accessories carried out at a qualified specialist workshop.

You could jeopardize the operating safety of your vehicle if you use parts, tires and wheels as well as accessories relevant to safety which have not been approved by Mercedes-Benz. Safety-relevant systems, e.g. the brake system, may malfunction. Only use Mercedes-Benz GenuineParts or parts of equal quality. Only use tires, wheels

and accessory parts that have been specifically approved for your vehicle model.

Mercedes-Benz GenuineParts are subject to strict quality inspections. Each part has been specially developed, manufactured or selected for Mercedes-Benz vehicles and adapted to them. Therefore, only Mercedes-Benz GenuineParts should be used.

More than 300,000 different Mercedes-Benz GenuineParts are available for Mercedes-Benz models.

All authorized Mercedes-Benz Centers maintain a supply of Mercedes-Benz GenuineParts for necessary service and repair work. In addition, strategically located parts delivery centers provide for quick and reliable parts service.

Always specify the vehicle identification number (VIN) (→ page 355) when ordering Mercedes-Benz GenuineParts.

## Operator's Manual

This Operator's Manual describes all models and all standard and optional equipment available for

your vehicle at the time of this Operator's Manual going to press. Country-specific differences are possible. Note that your vehicle may not be equipped with all features described. This is also the case for systems and functions relevant to safety. Therefore, the equipment on your vehicle may differ from that in the descriptions and illustrations.

The original purchase agreement for your vehicle contains a list of all of the systems in your vehicle.

Should you have any questions concerning equipment and operation, please consult an authorized Mercedes-Benz Center.

The Operator's Manual and Maintenance Booklet are important documents and should be kept in the vehicle.

### Service and vehicle operation

#### Vehicle operation outside the USA or Canada

When you are abroad with your vehicle, observe the following points:

- Service points or replacement parts may not be available immediately.
- Unleaded fuel may not be available for vehicles with a catalytic converter. Leaded fuel may cause damage to the catalytic converter.
- The fuel may have an extremely low octane number. Unsuitable fuel can cause engine damage.

Some Mercedes-Benz models are available in Europe through our European Delivery Program. For more information, please consult an authorized Mercedes-Benz service center, or write to one of the following address:

#### **In the USA:**

Mercedes-Benz USA, LLC  
European Delivery Department  
One Mercedes-Benz Drive  
Sandy Springs, GA 30328

#### **In Canada:**

Mercedes-Benz Canada, Inc.  
European Delivery Department  
98 Vanderhoof Avenue  
Toronto, Ontario M4G 4C9

#### Maintenance

Your customer advisor confirms the service in the service report.

#### Roadside Assistance

The Mercedes-Benz Roadside Assistance Program offers technical help in the case of a breakdown. Your calls to the toll-free Roadside Assistance Hotline are answered by our agents 24 hours a day, 365 days a year.

1-800-FOR-MERCEdes (1-800-367-6372) (USA)  
1-800-387-0100 (Canada)

You can find further information in the Mercedes-Benz Roadside Assistance Program brochure (USA) or the "Roadside Assistance"

section in the Service and Warranty booklet (Canada). You will find both in the vehicle document wallet.

### Change of address or change of ownership

In the event of a change of address, please send us the "Notification of address change" in the Service and Guarantee booklet or simply call the Mercedes-Benz Customer Assistance Center (USA) on the hotline number 1-800-FOR-MERCEdes (1-800-367-6372) or Customer Service (Canada) on 1-800-387-0100. We can then reach you in a timely fashion, if necessary.

If you sell your Mercedes, please leave all literature in the vehicle so that it is available to the next owner. If you have purchased a used vehicle, please send us the "Notice of Purchase of Used Car" in the Service and Guarantee booklet or simply call the Mercedes-Benz Customer Assistance Center (USA) at the hotline number 1-800-FOR-MERCEdes (1-800-367-6372) or Customer Service (Canada) at 1-800-387-0100.

### Possible danger due to substances hazardous to health

In compliance with Proposition 65 ("Prop65"), the following detachable label has been added to each vehicle sold in California:



### Operating safety

**⚠ WARNING** Risk of accident due to malfunctions or system failures

To avoid malfunctions or system failures:

- ▶ Always have the prescribed service and maintenance work as well any required

repairs carried out at a qualified specialist workshop.

**⚠ WARNING** Risk of accident or injury due to incorrect modifications on electronic component parts

Modification of electronic components, their software or wiring could impair their function and/or the function of other networked component parts or safety-relevant systems.

This can endanger the operating safety of the vehicle.

- ▶ Never tamper with the wiring and electronic component parts or their software.
- ▶ You should have all work on electrical and electronic components carried out at a qualified specialist workshop.

Observe the "On-board electronics" section in "Technical data".

**⚠ WARNING** Risk of fire due to flammable materials on hot parts of the exhaust system

Flammable material such as leaves, grass or twigs may ignite if they come into contact with hot parts of the exhaust system.

- ▶ When driving on unpaved roads or off-road, regularly check the vehicle underside.
- ▶ Remove trapped plants or other flammable material, in particular.
- ▶ If there is damage, consult a qualified specialist workshop immediately.

**! NOTE** Damage to the vehicle

In the following situations, in particular, there is a risk of damage to the vehicle:

- The vehicle becomes grounded, e.g. on a high curb or an unpaved road

- The vehicle is driven too fast over an obstacle, e.g. a curb, speed bump or pothole
- A heavy object strikes the underbody or chassis components

In situations such as this, the body, the underbody, chassis components, wheels or tires could be damaged without the damage being visible. Components damaged in this way can unexpectedly fail or, in the case of an accident, may not absorb the loads that arise as intended.

If the underbody paneling is damaged, flammable materials such as leaves, grass or twigs can collect between the underbody and the underbody paneling. These materials may ignite if they come into contact with hot parts on the exhaust system.

- ▶ Have the vehicle checked and repaired immediately at a qualified specialist workshop.

or

- ▶ If driving safety is impaired while continuing your journey, pull over and stop the vehicle immediately in accordance with the traffic conditions, and contact a qualified specialist workshop.

### Vehicles with a 48 V on-board electrical system (EQ Boost technology)

**⚠ DANGER** Risk of fatal injury by touching damaged high-voltage components

Vehicles with a 48 V on-board electrical system contain individual high-voltage components. These high-voltage components are under high voltage.

If you modify component parts of these high-voltage components or touch damaged component parts, you may be electrocuted.

High voltage components may be damaged in an accident, although the damage may not be visible.

- ▶ Never perform modifications to component parts of high-voltage components.

- ▶ Never touch damaged component parts of high-voltage components.
- ▶ Never touch component parts of high-voltage components after an accident.

Vehicles with a 48 V on-board electrical system contain high voltage components. These components are marked with a high voltage label:

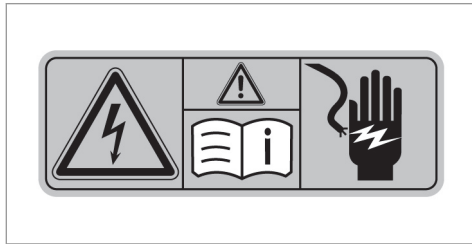

All work on high voltage components must be carried out at a qualified specialist workshop.

### Declaration of conformity for wireless vehicle components

**USA:** "Radio based devices of this vehicle comply with Part 15 of the FCC Rules. Operation is subject to the following two conditions: 1) These devices may not cause harmful interference, and 2) These devices must accept any interference received, including interference that may cause undesired operation. Changes or modifications not expressly approved by the party responsible for compliance could void the user's authority to operate the equipment."

**Canada:** "This vehicle contains license-exempt transmitter(s)/receiver(s) that comply with Innovation, Science and Economic Development Canada's RSS(s). Operation is subject to the following two conditions: (1) These devices may not cause interference, and (2) These devices must accept any interference that may cause undesired operation of the device."

**USA:** "Wireless charging system for mobile devices (model: WMI2 Wireless Mobile Interface):

This device complies with Part 18 of the FCC Rules."

The name and address of the responsible party is:

peiker acustic GmbH  
Max-Planck-Str. 28-32  
61381 Friedrichsdorf  
Germany

### Diagnostics connection

The diagnostics connection is only intended for the connection of diagnostic devices at a qualified specialist workshop.

**⚠ WARNING** Risk of accident due to connecting devices to the diagnostics connection

If you connect devices to the diagnostics connection of the vehicle, the function of vehicle systems and operating safety may be impaired.

- ▶ Only connect the vehicle diagnostics connection to devices which have been tested with regard to their suitability and are considered safe.

**⚠ WARNING** Risk of accident due to objects in the driver's footwell

Objects in the driver's footwell may impede pedal travel or block a depressed pedal.

This jeopardizes the operating and road safety of the vehicle.

- ▶ Stow all objects in the vehicle securely so that they cannot get into the driver's footwell.
- ▶ Always install the floor mats securely and as prescribed in order to ensure that there is always sufficient room for the pedals.
- ▶ Do not use loose floor mats and do not place floor mats on top of one another.

**!** **NOTE** Battery discharging from using devices connected to the diagnostics connection

Using devices at the diagnostics connection drains the battery.

- ▶ Check the charge level of the battery.
- ▶ If the charge level is low, charge the battery, e.g. by driving a considerable distance.

Connecting equipment to the diagnostics connection can lead to emissions monitoring information being reset, for example. This may lead to the vehicle failing to meet the requirements of the next emissions inspection during the main inspection.

**Qualified specialist workshop**

An authorized Mercedes-Benz Center is a qualified specialist workshop. It has the necessary special skills, tools and qualifications to correctly carry out the work required on your vehi-

cle. This particularly applies to safety-relevant works.

For the following, always have your vehicle checked at an authorized Mercedes-Benz Center:

- safety-relevant works
- service and maintenance work
- repair work
- modifications as well as installations and conversions
- work on electronic components
- **vehicles with 48 V on-board electrical system (EQ boost technology):** work on high voltage components of the 48 V on-board electrical system

Mercedes-Benz recommends a Mercedes-Benz service center.

**Correct use of the vehicle**

If you remove any warning stickers, you or others could fail to recognize certain dangers. Leave warning stickers in position.



Observe the following information in particular when driving your vehicle:

- the safety notes in this manual
- technical data for the vehicle
- traffic rules and regulations
- laws and safety standards pertaining to motor vehicles

### Sport Utility Vehicle

**⚠ WARNING** Risk of accident when the center of gravity is too high

The vehicle may start to skid and rollover in the event of sudden steering maneuvers and/or when the vehicle's speed is not adapted to the road conditions.

- ▶ Always adapt your speed and driving style to the vehicle's driving characteristics and to the prevailing road and weather conditions.

Utility vehicles have a significantly higher rollover rate than other types of vehicles.

If this type of vehicle is not driven safely, an accident can occur, the vehicle can roll over and occupants can suffer serious or even fatal injuries.

In a rollover crash, an unbelted person is significantly more likely to die than a person wearing a seat belt.

You and all vehicle occupants should always wear your seat belts.

### Notes for persons with electronic medical aids

Mercedes-Benz AG cannot, despite carefully developing vehicle systems, completely rule out the interaction of vehicle systems with electronic medical aids such as cardiac pacemakers.

For this reason, the following can occur in isolated cases, depending on the aids used:

- Aids malfunctioning
- Adverse health effects

Observe the notes and warnings of the manufacturer of the aids; if in doubt, contact the device

manufacturer and your doctor. Mercedes-Benz AG recommends using only few electrical vehicle systems if there is continuing uncertainty concerning the possibility of aids malfunctioning.

Have repairs and maintenance work in the area of vehicle components carrying live voltage and transmission antenna carried out by a qualified specialist workshop.

### Problems with your vehicle

If you should experience a problem with your vehicle, particularly one that you believe may affect its safe operation, we urge you to contact an authorized Mercedes-Benz Center immediately to have the problem diagnosed and rectified. If the problem is not resolved to your satisfaction, please discuss the problem again with an authorized Mercedes-Benz Center or, if necessary, contact us at one of the following addresses:

#### In the USA:

Mercedes-Benz USA, LLC

Customer Assistance Center  
One Mercedes-Benz Drive  
Sandy Springs, GA 30328

**In Canada:**

Mercedes-Benz Canada, Inc.  
Customer Relations Department  
98 Vanderhoof Avenue  
Toronto, Ontario M4G 4C9

**Reporting safety defects**

**USA only:**

The following text is published as required of manufacturers under Title 49, Code of U.S. Federal Regulations, Part 575 pursuant to the "National Traffic and Motor Vehicle Safety Act of 1966".

If you believe that your vehicle has a defect which could cause a crash or could cause injury or death, you should immediately inform the National Highway Traffic Safety Administration (NHTSA) in addition to notifying Mercedes-Benz USA, LLC.

If NHTSA receives similar complaints, it may open an investigation, and if it finds that a safety defect exists in a group of vehicles, it may order a recall and remedy campaign. However, NHTSA cannot become involved in individual problems between you, your dealer, or Mercedes-Benz USA, LLC.

To contact NHTSA, you may call the Vehicle Safety Hotline toll-free at 1-888-327-4236 (TTY: 1-800-424-9153); go to the <https://www.safercar.gov/>; or write to: Administrator, NHTSA, 400 Seventh Street, SW., Washington, DC 20590.; USA.

You can also obtain other information about motor vehicle safety from: <https://www.safercar.gov>

**Canada only:**

The following text is published as required of manufacturers under subsection 18.4 (4) of the Motor Vehicle Safety Regulations.

If you believe that your vehicle has a defect which could cause a crash or could cause injury or death, you should immediately inform Trans-

port Canada in addition to notifying Mercedes-Benz Canada Inc.

If Transport Canada received similar complaints, it may open an investigation, and if it finds that a safety defect exists in a group of vehicles, it may order a recall and remedy campaign. However, Transport Canada cannot become involved in individual problems between you, your dealer or Mercedes-Benz Canada Inc.

To contact Transport Canada, you may call the Defect Investigations and Recalls Division toll-free in Canada at 1-800-333-0510 or 819-994-3328 in the Gatineau-Ottawa area or internationally; you may also go to the following websites for more information:

- English: <https://www.tc.gc.ca/recalls>
- French: <https://www.tc.gc.ca/rappels>

### Limited Warranty

**!** **NOTE** Damage to the vehicle arising from violation of these operating instructions.

Damage to the vehicle can arise from violation of these operating instructions.

This damage is not covered either by the Mercedes-Benz implied warranty or by the New- or Used-Vehicle Warranty.

▶ Follow the instructions in these operating instructions on proper operation of your vehicle as well as on possible vehicle damage.

### QR code for rescue card

The QR code is secured in the fuel filler flap and on the opposite side on the B-pillar. In the event of an accident, rescue services can use the QR code to quickly find the appropriate rescue card for your vehicle. The current rescue card contains the most important information about your

vehicle in a compact form, e.g. the routing of the electric lines.

Further information can be obtained at <https://www.mercedes-benz.de/qr-code>.

### Data storage

#### Electronic control units

Electronic control units are installed in your vehicle. Some of these are necessary for the safe operation of your vehicle, while some assist you when driving (driver assistance systems). In addition, your vehicle provides comfort and entertainment functions, which are also made possible by electronic control units.

Electronic control units contain data memories which can temporarily or permanently store technical information about the vehicle's operating state, component loads, maintenance requirements and technical events or malfunctions.

In general, this information documents the state of a component part, a module, a system or the surroundings such as:

- Operating status of system components (e.g. fill levels, battery status, tire pressure)
- Status messages concerning the vehicle or its individual components (e.g. number of wheel revolutions/speed, longitudinal acceleration, lateral acceleration, display of fastened seat belts)
- Malfunctions or faults in important system components (e.g. lights, brakes)
- Information on events leading to vehicle damage
- System reactions in special driving situations (e.g. airbag deployment, intervention of stability control systems)
- Ambient conditions (e.g. temperature, rain sensor)

In addition to providing the actual control unit function, this data assists the manufacturer in detecting and rectifying malfunctions and optimizing vehicle functions. The majority of this

data is temporary and is only processed in the vehicle itself. Only a small portion of the data is stored in the event or fault memory.

When your vehicle is serviced, technical data from the vehicle can be read out by service network employees (e.g. workshops, manufacturers) or third parties (e.g. breakdown services). Services include, for example, repair services, maintenance processes, warranty claims and quality assurance measures. The read out is performed via the legally prescribed port for the diagnostics connection in the vehicle. The respective service network locations or third parties collect, process and use the data. They document technical statuses of the vehicle, assist in finding faults and improving quality and are transmitted to the manufacturer, if necessary. Furthermore, the manufacturer is subject to product liability. For this, the manufacturer requires technical data from vehicles.

Fault memories in the vehicle can be reset by a service outlet as part of repair or maintenance work.

Depending on the selected equipment, you can import data into vehicle convenience and information functions yourself.

This includes, for example:

- Multimedia data such as music, films or photos for playback in an integrated multimedia system
- Address book data for use in connection with an integrated hands-free system or an integrated navigation system
- Entered navigation destinations
- Data about the use of Internet services

This data can be saved locally in the vehicle or it is located on a device which you have connected to the vehicle (e.g. a smartphone, USB flash drive or MP3 player). If this data is stored in the vehicle, you can delete it at any time. This data is sent to third parties only at your request, particularly when you use online services in accordance with the settings that you have selected.

You can store or change convenience settings/individualization in the vehicle at any time.

Depending on the equipment, this includes, for example:

- Settings for the seat and steering wheel positions
- Suspension and climate control settings
- Customizations such as interior lighting

If your vehicle is accordingly equipped, you can connect your smartphone or another mobile end device to the vehicle. You can control this by means of the control elements integrated in the vehicle. Images and audio from the smartphone can be output via the multimedia system. Certain information is simultaneously transferred to your smartphone.

Depending on the type of integration, this can include:

- General vehicle data
- Position data

This allows you to use selected apps on your smartphone, such as navigation or music playback. There is no further interaction between the smartphone and the vehicle; in particular, vehicle data is not directly accessible. Which type of

further data processing occurs is determined by the provider of the specific app used. Which settings you can make, if any, depends on the specific app and the operating system of your smartphone.

### Online services

---

#### Wireless network connection

If your vehicle has a wireless network connection, it enables data to be exchanged between your vehicle and additional systems. The wireless network connection is enabled via the vehicle's transmission and reception unit or via connected mobile end devices (e.g. smartphones). Online functions can be used via the wireless network connection. This includes online services and applications/apps provided by the manufacturer or other providers.

#### Manufacturer's services

Regarding online services of the manufacturer, the individual functions are described by the manufacturer in a suitable place (e.g. Operator's Manual, website of the manufacturer) along with the relevant data protection information. Per-

sonal data may be used for the provision of online services. Data is exchanged via a secure connection, e.g. the manufacturer's designated IT systems. Personal data is collected, processed and used via the provision of services exclusively on the basis of legal permissions or with prior consent.

The services and functions (sometimes subject to a fee) can usually be activated or deactivated. In some cases, this also applies to the entire vehicle's data connection. This excludes, in particular, legally prescribed functions and services.

#### Third party services

If it is possible to use online services from other providers, these services are the responsibility of the provider in question and subject to that provider's data protection conditions and terms of use. The manufacturer has no influence on the content exchanged.

For this reason, please ask the service provider for information about the type, extent and purpose of the collection and use of personal data when services are provided by third parties.

### MBUX multimedia system/Mercedes me connect

---

If the vehicle is equipped with the MBUX multimedia system or Mercedes me connect, additional data about the vehicle's operation, the use of the vehicle in certain situations, and the location of the vehicle may be compiled by the MBUX multimedia system or Mercedes me connect.

For additional information, please refer to the "MBUX multimedia system" section and/or the Mercedes me connect Terms and Conditions.

### Event data recorders

---

#### USA only:

This vehicle is equipped with an event data recorder (EDR). The main purpose of an EDR is to record, in certain crash or near crash-like situations, such as an airbag deployment or hitting a road obstacle, data that will assist in understanding how a vehicle's systems performed. The EDR is designed to record data related to

vehicle dynamics and safety systems for a short period of time, typically 30 seconds or less.

The EDR in this vehicle is designed to record such data as:

- How various systems in your vehicle were operating
- Whether or not the driver and front passenger seat belts were buckled/fastened
- How far (if at all) the driver was depressing the accelerator and/or brake pedal and
- How fast the vehicle was traveling

This data can help provide a better understanding of the circumstances in which accidents and injuries occur. NOTE: EDR data is recorded by your vehicle only if a non-trivial crash situation occurs; no data is recorded by the EDR under normal driving conditions and no personal data (e.g. name, gender, age and accident location) is recorded. However, other parties, such as law enforcement, could combine EDR data with the type of personally identifying data routinely acquired during a crash investigation.

To read data recorded by an EDR, special equipment is required, and access to the vehicle or the EDR is needed. In addition to the vehicle manufacturer, other parties that have the special equipment, such as law enforcement, can read the information by accessing the vehicle or the EDR.

EDR data may be used in civil and criminal matters as a tool in accident reconstruction, accident claims and vehicle safety. Since the Crash Data Retrieval (CDR) tool that is used to extract data from the EDR is commercially available, Mercedes-Benz USA, LLC ("MBUSA") expressly disclaims any and all liability arising from the extraction of this information by unauthorized Mercedes-Benz personnel.

MBUSA will not share EDR data with others without the consent of the vehicle owner or, if the vehicle is leased, without the consent of the lessee. Exceptions to this representation include responses to subpoenas by law enforcement; by federal, state or local government; in connection with or arising out of litigation involving MBUSA or its subsidiaries and affiliates; or, as required by law.

Warning: The EDR is a component of the Restraint System Module. Tampering with, altering, modifying or removing the EDR component may result in a malfunction of the Restraint System Module and other systems.

State laws or regulations regarding EDRs that conflict with federal regulation are pre-empted. This means that in the event of such conflict, the federal regulation governs. As of December 2016, 17 states have enacted laws relating to EDRs.

### Copyright

#### Free and open source software

---

Information on license for free and open-source software used in your vehicle can be found on the data carrier in your vehicle document wallet and with updates on the following website:

<https://www.mercedes-benz.com/opensource>

### Registered trademarks

- Bluetooth® is a registered trademark of Bluetooth SIG, Inc.
- DTS™ is a registered trademark of DTS, Inc.
- Dolby® and MLP™ are registered trademarks of DOLBY Laboratories.
- BabySmart™, ESP® and PRE-SAFE® are registered trademarks of Mercedes-Benz AG.
- HomeLink® is a registered trademark of Genex Corporation.
- iPod® and iTunes® are registered trademarks of Apple Inc.
- Burmester® is a registered trademark of Burmester Audiosysteme GmbH.
- Microsoft® and Windows Media® are registered trademarks of Microsoft Corporation.
- SIRIUS® is a registered trademark of Sirius XM Radio Inc.
- HD Radio™ is a registered trademark of iBiquity Digital Corporation.
- Gracenote® is a registered trademark of Gracenote, Inc.
- ZAGATSurvey® and related brands are registered trademarks of ZagatSurvey, LLC.

## Restraint system

### Protection provided by the restraint system

The restraint system includes the following components:

- Seat belt system
- Airbags
- Child restraint system
- Child seat securing systems

The restraint system can help prevent the vehicle occupants from coming into contact with parts of the vehicle interior in the event of an accident. In the event of an accident, the restraint system can also reduce the forces to which the vehicle occupants are subjected.

A seat belt can only provide the best level of protection if it is worn correctly. Depending on the detected accident situation, Emergency Tensioning Devices and/or airbags supplement the protection offered by a correctly worn seat belt. Emergency Tensioning Devices and/or airbags are not deployed in every accident.

In order for the restraint system to provide the intended level of protection, each vehicle occupant must observe the following information:

- Fasten seat belts correctly.
- Sit in an almost upright seat position with their back against the seat backrest.
- Sit with their feet resting on the floor, if possible.
- Always secure persons under 5 ft (1.50 m) tall in an additional restraint system suitable for Mercedes-Benz vehicles.

However, no system available today can completely eliminate injuries and fatalities in every accident situation. In particular, the seat belt and airbag generally do not protect against objects penetrating the vehicle from the outside. It is also not possible to completely rule out the risk of injury caused by the airbag deploying.

### Reduced restraint system protection

**⚠ WARNING** Risk of injury or death due to modifications to the restraint system

Vehicle occupants may no longer be protected as intended if alterations are made to the restraint system.

- ▶ Never alter the parts of the restraint system.
- ▶ Never tamper with the wiring or any electronic component parts or their software.

If it is necessary to modify the vehicle to accommodate a person with disabilities, contact an authorized Mercedes-Benz Center for details.

USA only: for details, contact our Customer Assistance Center on 1-800-FOR-MERCEdes (1-800-367-6372).

### Restraint system functionality



When the ignition is switched on, a self-test is performed, during which the  restraint sys-



tem warning lamp lights up. It goes out no later than a few seconds after the vehicle is started. The components of the restraint system are then functional.

### Malfunctioning restraint system

A malfunction has occurred in the restraint system if:

- The  restraint system warning lamp does not light up when the ignition is switched on
- The  restraint system warning lamp lights up continuously or repeatedly during a journey

**⚠ WARNING** Risk of injury due to malfunctions in the restraint system

Components in the restraint system may be activated unintentionally or not deploy as planned in an accident.

- ▶ Have the restraint system checked and repaired immediately at a qualified specialist workshop.

### Function of the restraint system in an accident

How the restraint system works is determined by the severity of the impact detected and the type of accident anticipated:

- Frontal impact
- Rear impact
- Side impact
- Rollover

The activation thresholds for the components of the restraint system are determined based on the evaluation of the sensor values measured at various points in the vehicle. This process is pre-emptive in nature. The triggering/deployment of the components of the restraint system must take place in good time at the start of the collision.

Factors which can only be seen and measured after a collision has occurred do not play a decisive role in the deployment of an airbag. Nor do they provide an indication of airbag deployment.

The vehicle may be deformed significantly without an airbag being deployed. This is the case if

only parts which are relatively easily deformed are affected and the rate of vehicle deceleration is not high. Conversely, an airbag may be deployed even though the vehicle suffers only minor deformation. If very rigid vehicle parts such as longitudinal members are hit, this may result in sufficiently high levels of vehicle deceleration.

Depending on the detected deployment situation, the components of the restraint system can be activated or deployed independently of each other:

- Emergency Tensioning Device: frontal impact, rear impact, side impact, rollover
- Driver's airbag, front passenger airbag: frontal impact
- Knee airbag: frontal impact
- Side airbag: side impact
- Window curtain airbag: side impact, rollover, frontal impact
- PRE-SAFE® Impulse Side: side impact

The front passenger airbag can only be deployed in an accident if the PASSENGER AIR BAG OFF

indicator lamp is off. If the front passenger seat is occupied, make sure, both before and during the journey, that the status of the front passenger airbag is correct (→ page 46).

**⚠ WARNING** Risk of burns from hot air bag components

The air bag parts are hot after an air bag has been deployed.

- ▶ Do not touch the air bag parts.
- ▶ Have a deployed air bag replaced at a qualified specialist workshop as soon as possible.

Mercedes-Benz recommends that you have the vehicle towed to a qualified specialist workshop after an accident. Take this into account, particularly if an Emergency Tensioning Device is triggered or an airbag deployed.

If the Emergency Tensioning Devices are triggered or an airbag is deployed, you will hear a bang, and a small amount of powder may also be released:

- The bang will not generally affect your hearing.
- In general, the powder released is not hazardous to health but may cause short-term breathing difficulties to persons suffering from asthma or other pulmonary conditions. Provided it is safe to do so, leave the vehicle immediately or open the window in order to prevent breathing difficulties.

Airbags and pyrotechnic Emergency Tensioning Devices contain perchlorate material, which may require special handling or environmental protection measures. National guidelines regarding waste disposal must be observed. In California, see <https://dtsc.ca.gov/>. Using the search function, you will find information on perchlorate, for example.

## Seat belts

### Protection provided by the seat belt

Always fasten your seat belt correctly before starting a journey. A seat belt can only provide the best level of protection if it is worn correctly.

**⚠ WARNING** Risk of injury or death due to incorrectly fastened seat belt

If the seat belt is not worn correctly, it cannot perform its intended protective function.

In addition, an incorrectly fastened seat belt can also cause injuries, for example, in the event of an accident or when braking or changing direction suddenly.

- ▶ Always ensure that all vehicle occupants have their seat belts fastened correctly and are sitting properly.

Always observe the instructions about the correct driver's seat position and adjusting the seat (→ page 88).

In order for the correctly worn seat belt to provide the intended level of protection, each vehicle occupant must observe the following information:

- The seat belt must not be twisted and must fit tightly and snugly across the body.
- The seat belt must be routed across the center of the shoulder and as low down across the hips as possible.
- The shoulder section of the seat belt should not touch your neck nor be routed under your arm or behind your back.
- Avoid wearing bulky clothing, e.g. a winter coat.
- Push the lap belt down as far as possible across your hips and pull tight with the shoulder section of the belt. Never route the lap belt across your abdomen.  
Pregnant women must also take particular care with this.
- Never route the seat belt across sharp, pointed, abrasive or fragile objects.

- Only one person should use each seat belt at any one time. Never allow babies and children to travel sitting on the lap of another vehicle occupant.
- Never secure objects with a seat belt if the seat belt is also being used by one of the vehicle's occupants. Always observe the instructions for loading the vehicle when securing objects, luggage or loads (→ page 102).  
Also ensure that no objects, e.g. a cushion, are ever placed between a person and the seat.

The seat belts on the following seats are equipped with a special seat belt retractor:

- Front passenger seat
- Rear seats

Activate or deactivate the special seatbelt retractor (→ page 55).

If children are traveling in the vehicle, be sure to observe the instructions and safety notes on "Children in the vehicle" (→ page 52).

### Limitations of the protection provided by the seat belt

**⚠ WARNING** Risk of injury or death due to an incorrect seat position

The seat belt does not offer the intended level of protection if you have not moved the seat backrest to an almost vertical position.

You could slip beneath the seat belt and injure yourself.

- ▶ Adjust the seat properly before commencing your journey.
- ▶ Always ensure that the seat backrest is in an almost vertical position and that the shoulder belt is routed across the center of your shoulder.

**⚠ WARNING** Risk of injury or death when additional restraint systems are not used for persons with a smaller stature

Persons under 5 ft (1.50 m) tall cannot wear the seat belt correctly without a suitable additional restraint system.

- ▶ Always secure persons under 5 ft (1.50 m) tall in a suitable restraint system.

**⚠ WARNING** Danger of injury or death due to blocked seat belt anchorage

The restraint effect of the seat belt is impaired if objects between the front seat and the door are blocking the movable seat belt anchorage on the front seat.

- ▶ Before starting a journey, make sure that there are no objects between the front seat and the door.

**⚠ WARNING** Risk of injury or death due to damaged or modified seat belts

Seat belts cannot provide protection in the following situations:

- The seat belt is damaged, has been modified, is extremely dirty, bleached or dyed

- The seat belt buckle is damaged or extremely dirty
- Modifications have been made to the Emergency Tensioning Device, seat belt anchorage or seat belt retractor

Seat belts may sustain non-visible damage in an accident, e.g. due to glass splinters.

Modified or damaged seat belts could tear or fail in the event of an accident, for example.

Modified Emergency Tensioning Devices may be deployed unintentionally or not function as intended.

- ▶ Never modify the seat belts, Emergency Tensioning Devices, seat belt anchorages or seat belt retractors.
- ▶ Make sure that the seat belts are not damaged, are not worn and are clean.
- ▶ Always have the seat belts checked immediately after an accident at a qualified specialist workshop.

Only use seat belts which have been approved for your vehicle by Mercedes-Benz.

**⚠ WARNING** Risk of injury or death from deployed pyrotechnic Emergency Tensioning Devices

Pyrotechnic Emergency Tensioning Devices that have been deployed are no longer operational and are unable to perform their intended protective function.

- ▶ Therefore, have deployed pyrotechnic Emergency Tensioning Devices immediately replaced at a qualified specialist workshop.

Mercedes-Benz recommends that you have the vehicle towed to a qualified specialist workshop after an accident.

**! NOTE** Damage caused by trapping the seat belt

If an unused seat belt is not fully retracted, it may become trapped in the door or in the seat mechanism.

- ▶ Always ensure that an unused seat belt is fully retracted.

### Fastening and adjusting the seat belts

If the seat belt is pulled quickly or sharply, the seat belt retractor locks. The seat belt strap cannot be pulled out any further.

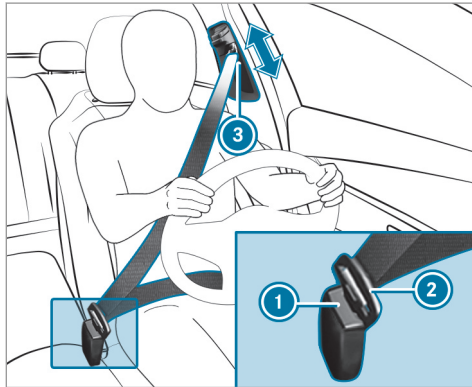

- ▶ Always engage seat belt tongue ② of the seat belt into seat belt buckle ① of the corresponding seat.

- ▶ Press and hold the seat belt outlet release and slide seat belt outlet ③ into the desired position.
- ▶ Let go of the seat belt outlet release and ensure that seat belt outlet ③ locks into position.

**!** **NOTE** Deployment of the Emergency Tensioning Device and side air bag when the front passenger seat is unoccupied

If the seat belt tongue is engaged in the seat belt buckle of the unoccupied front passenger seat, the Emergency Tensioning Device and the side air bag may also deploy in the event of an accident along with other systems.

- ▶ Only one person should use each seat belt at any one time.

### Seat belt adjustment function

**Vehicles with PRE-SAFE®:** If the front seat belt is not pulled tightly across your body, the seat belt adjustment may automatically apply a cer-

tain tightening force. Do not hold the seat belt tightly while it is adjusting.

You can activate and deactivate the seat belt adjustment function using the multimedia system (→ page 41).

### Releasing seat belts

- ▶ Press the release button in the seat belt buckle and guide the seat belt back with the seat belt tongue.

### Activating/deactivating seat belt adjustment via the multimedia system

Multimedia system:

→ ▶ Settings ▶ Vehicle

- ▶ Activate or deactivate **Belt Adjustment**.

### Seat belt warning function for the driver and front passenger

The seat belt warning lamp in the instrument display is a reminder that all vehicle occupants must wear their seat belts correctly.

## 42 Occupant safety

The  seat belt warning lamp lights up for six seconds every time the vehicle is started.

In addition, a warning tone may sound.

When the driver's and front passenger's doors are closed and the driver and front passenger have fastened their seat belts, the seat belt warning goes out.

In the following cases, the seat belt warning lights up during a journey if:

- The vehicle speed exceeds 15 mph (25 km/h) and the driver's or front passenger seat belt is not fastened.
- The driver or front passenger unfastens their seat belt while the vehicle is in motion.

### Airbags

#### Overview of airbags

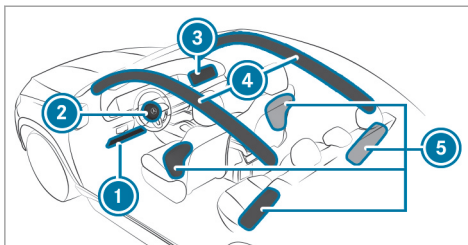

- ① Driver's knee airbag
- ② Driver's airbag
- ③ Front passenger airbag
- ④ Window curtain airbag
- ⑤ Side airbag

The installation location of an airbag is identified by the AIRBAG symbol.

When enabled, an airbag can provide additional protection for the respective vehicle occupant.

Potential protection provided by each airbag:

- Knee airbag: thigh, knee and lower leg
- Driver's airbag, front passenger airbag: head and ribcage
- Window curtain airbag: head
- Side airbag: ribcage and pelvis

**⚠ WARNING** Risk of injury or fatal injuries if the front passenger airbag is enabled

If the front passenger airbag is enabled, a child on the front passenger seat may be struck by the front passenger airbag during an accident.

NEVER use a rearward facing child restraint system on a seat protected by an ENABLED FRONT AIRBAG in front of it, this can result in DEATH or SERIOUS INJURY to the child.

When installing a child restraint system on the front passenger seat, observe the vehicle-specific information (→ page 61). Also, always observe the notes on rearward-facing or forward-facing child restraint systems on the front passenger seat.

### Information on automatic front passenger airbag shutoff

The front passenger airbag can only be deployed in an accident if the PASSENGER AIR BAG OFF indicator lamp is off. If the front passenger seat is occupied, make sure, both before and during the journey, that the status of the front passenger airbag is correct (→ page 46).

**!** **NOTE** Important points to remember if the front passenger seat is unoccupied

In an accident, the components of the restraint system may deploy unnecessarily on the front passenger side if:

- There are heavy objects on the front passenger seat.
- The seat belt tongue is engaged in the seat belt buckle of the front passenger seat and the front passenger seat is unoccupied.

- ▶ Stow objects in a suitable place.
- ▶ Only one person should use each seat belt at any one time.

Depending on the detected accident situation, the window curtain airbag on the front passenger side may deploy. The airbag is deployed regardless of whether the front passenger seat is occupied.

### Protection provided by the airbags

Depending on the accident situation, an airbag may supplement the protection provided by a correctly fastened seat belt.

**!** **WARNING** Risk of injury or death due to an incorrect seat position

If you deviate from the correct seat position, the airbag cannot perform its intended protective function.

Each vehicle occupant must make sure of the following:

- Fasten seat belts correctly. Pregnant women must take particular care to ensure that the lap belt never lies across the abdomen.

- Adopt the correct seat position and keep as far away as possible from the airbags.
- Observe the following information.
- ▶ Always make sure that there are no objects between the airbag and vehicle occupant.

To avoid the risks resulting from the deployment of an airbag, each vehicle occupant must observe the following information in particular:

- Before starting your journey, adjust your seat correctly; the driver's seat and front passenger seat should be moved as far back as possible.

When doing so, always observe the information on the correct driver's seat position (→ page 88).

- Only hold the steering wheel by the steering wheel rim. This allows the airbag to be fully deployed.
- Always lean against the seat backrest when the vehicle is in motion. Do not lean forwards or against the door or side window. You may

## 44 Occupant safety

otherwise be in the deployment area of the airbags.

- Always keep your feet on the floor. Do not put your feet on the cockpit, for example. Your feet may otherwise be in the deployment area of the airbag.
- If children are traveling in the vehicle, observe the additional notes (→ page 52).
- Always stow and secure objects correctly.

Objects in the vehicle interior may prevent an airbag from functioning correctly. Each vehicle occupant must always make sure of the following in particular:

- There are no people, animals or objects between the vehicle occupants and an airbag.
- There are no objects between the seat, door and door pillar (B-pillar).
- There are no hard objects, e.g. coat hangers, hanging on the grab handles or coat hooks.
- There are no accessory parts, such as mobile navigation devices, mobile phones or cup holders, attached to the vehicle within the

deployment area of an airbag, e.g. on the cockpit, on the door, on the side window or on the side wall trim.

In addition, no connecting cables, tensioning straps or retaining straps must be routed or attached to the vehicle within the deployment area of an airbag. Always comply with the accessory manufacturer's installation instructions and, in particular, the notes on suitable places for installation.

- There are no heavy, sharp-edged or fragile objects in the pockets of your clothing. Store such objects in a suitable place.

### Limited protection provided by airbags

**⚠ WARNING** Risk of injury due to modifications to the cover of an airbag

If you modify the cover of an airbag or affix objects such as stickers to it, the airbag may no longer function correctly.

- ▶ Never modify the cover of an airbag and do not affix objects to it.

The installation location of an airbag is identified by the airbag symbol (→ page 42).

**⚠ WARNING** Risk of injury or death due to the use of unsuitable seat covers

Due to unsuitable seat covers, the airbags cannot protect vehicle occupants as intended.

In addition, the operation of the automatic front passenger airbag shutoff could be restricted.

- ▶ You should only use seat covers that have been approved for the corresponding seats by Mercedes-Benz.

**⚠ WARNING** Risk of injury due to malfunctioning sensors in the door

The function of the airbags can be impaired due to modifications or incorrect work performed on the doors or door trim, or if the doors are damaged.

- ▶ Never modify the doors or parts of the doors.



- ▶ Always have work on the doors or door trim carried out at a qualified specialist workshop.

**▲ WARNING** Risk of injury due to deployed airbag

A deployed airbag no longer offers any protection.

- ▶ Have the vehicle towed to a qualified specialist workshop in order to have the deployed airbag replaced.

Have deployed airbags replaced immediately.

### Status of the front passenger front airbag

#### Function of the automatic front passenger airbag shutoff

The automatic front passenger airbag shutoff is able to detect whether the front passenger seat is occupied by a person or a child restraint system. The front passenger airbag is enabled or disabled accordingly.

When installing a child restraint system on the front passenger seat, always make sure of the following:

- Ensure that the child restraint system is positioned correctly (→ page 51).
- Always comply with the child restraint system manufacturer's installation instructions.
- Never place objects (e.g. cushions) under or behind the child restraint system.
- Fully retract the seat cushion length adjustment.
- The entire base of the child restraint system must always rest on the sitting surface of the front passenger seat.
- The backrest of the forward-facing child restraint system must, as far as possible, be resting on the seat backrest of the front passenger seat.
- The child restraint system must not touch the roof or be put under strain by the head restraints. Adjust the seat backrest inclination and the head restraint setting accordingly.

**▲ WARNING** Risk of injury or death due to objects between the seat surface and the child restraint system

Objects between the sitting surface and the child restraint system could affect the function of the automatic front passenger airbag shutoff.

- ▶ Do not place any objects between the sitting surface and the child restraint system.
- ▶ The entire base of the child restraint system must always rest on the sitting surface of the front passenger seat.
- ▶ The backrest of the forward-facing child restraint system must, as far as possible, be resting on the seat backrest of the front passenger seat.
- ▶ Always comply with the child restraint system manufacturer's installation instructions.

## 46 Occupant safety

A person on the front passenger seat must observe the following information:

- Fasten seat belts correctly (→ page 38).
- Sit in an almost upright seat position with their back against the seat backrest.
- Sit with their feet resting on the floor, if possible.

The front passenger airbag may otherwise be disabled by mistake, for example, in the following situations:

- The front passenger transfers their weight by supporting themselves on a vehicle armrest.
- The front passenger sits in such a way that their weight is raised from the sitting surface.

**⚠ WARNING** Risk of injury or death due to a disabled front passenger airbag

The front passenger airbag is disabled when the PASSENGER AIR BAG OFF indicator lamp is lit.

A person in the front passenger seat could then, for example, come into contact with the vehicle interior, especially if the person is sitting too close to the cockpit.

If the front passenger seat is occupied, always ensure that:

- The classification of the person in the front passenger seat is correct and the front passenger airbag is enabled or disabled in accordance with the person in the front passenger seat.
  - The front passenger seat has been moved as far back as possible.
  - The person is seated correctly.
- ▶ Both before and during the journey, ensure that the status of the front passenger airbag is correct.

If the front passenger seat is occupied, the classification of the person or child restraint system on the front passenger seat takes place after the front passenger airbag shutoff self-test. The PASSENGER AIR BAG indicator lamps display the status of the front passenger airbag.

Always observe the notes on the function of the PASSENGER AIR BAG indicator lamps (→ page 46).

### Function of the PASSENGER AIR BAG indicator lamps



### Self-test of automatic front passenger airbag shutoff

When the ignition is switched on, a self-test is performed during which the two PASSENGER AIR BAG ON and OFF indicator lamps light up simultaneously.

The status of the front passenger airbag is displayed via the PASSENGER AIR BAG indicator lamps after the self-test:

- **ON is lit:** the front passenger airbag may deploy during an accident.  
The indicator lamp goes out after approximately 60 seconds.
- **ON and OFF are not lit:** the front passenger airbag may deploy during an accident.
- **OFF is lit:** the front passenger airbag is disabled. It will then not be deployed in the event of an accident.

If the PASSENGER AIR BAG ON indicator lamp is off, only the PASSENGER AIR BAG OFF indicator lamp shows the status of the front passenger airbag. The PASSENGER AIR BAG OFF indicator lamp may be lit continuously or be off.

If the PASSENGER AIR BAG OFF indicator lamp and the  restraint system warning lamp light up simultaneously, the front passenger seat may not be used. Also in this case, do not install a child restraint system on the front passenger seat. Have the automatic front passenger airbag shutoff checked and repaired immediately at a qualified specialist workshop.

### Status display

If the front passenger seat is occupied, ensure, both before and during the journey, that the status of the front passenger airbag is correct for the current situation.

**After installing a rearward-facing child restraint system on the front passenger seat:** PASSENGER AIR BAG OFF must be lit continuously.

**⚠ WARNING** Risk of injury or death when using a rearward-facing child restraint system while the front passenger airbag is enabled

If you secure a child in a rearward-facing child restraint system on the front passenger seat and the PASSENGER AIR BAG OFF indicator lamp is off, the front passenger airbag can deploy in the event of an accident.

The child could be struck by the airbag.

Always ensure that the front passenger airbag is disabled. The PASSENGER AIR BAG OFF indicator lamp must be lit.

NEVER use a rearward-facing child restraint system on a seat with an ENABLED FRONT AIRBAG; DEATH or SERIOUS INJURY to the CHILD can occur.

When installing a child restraint system on the front passenger seat, observe the vehicle-specific information (→ page 61).

Depending on the child restraint system and the stature of the child, the PASSENGER AIR BAG OFF indicator lamp may be off. In this case, do

not install the rearward-facing child restraint system on the front passenger seat.

Instead, install the rearward-facing child restraint system on a suitable rear seat.

**After installing a forward-facing child restraint system on the front passenger seat:**

depending on the child restraint system and the stature of the child, PASSENGER AIR BAG OFF may be lit continuously or be off. Always observe the following information.

**⚠ WARNING** Risk of injury or death due to incorrect positioning of the forward-facing child restraint system

If you secure a child in a forward-facing child restraint system on the front passenger seat that is positioned too close to the cockpit, in the event of an accident, the child could:

- come into contact with the vehicle interior if the PASSENGER AIR BAG OFF indicator lamp is lit, for example
- be struck by the airbag if the PASSENGER AIR BAG OFF indicator lamp is off.

- ▶ Always move the front passenger seat as far back as possible and fully retract the seat cushion length adjustment. While doing so, always make sure that the shoulder belt strap is correctly routed from the seat belt outlet of the vehicle to the shoulder belt guide on the child restraint system. The shoulder belt strap must be routed forwards and downwards from the seat belt outlet. If necessary, adjust the seat belt outlet and the front passenger seat accordingly.
- ▶ Always comply with the child restraint system manufacturer's installation instructions.

When installing a child restraint system on the front passenger seat, observe the vehicle-specific information (→ page 61).

**If a person is sitting on the front passenger seat:** PASSENGER AIR BAG OFF may be lit continuously or be off, depending on the person's stature.

A person on the front passenger seat must always observe the following information:

- If the front passenger seat is occupied by an adult or a person with a stature corresponding to that of an adult, the PASSENGER AIR BAG OFF indicator lamp must be off. This indicates that the front passenger airbag is enabled.

If the PASSENGER AIR BAG OFF indicator lamp is lit continuously, an adult or person with a build corresponding to that of an adult should not use the front passenger seat.

Instead, they should use a rear seat.

- If the front passenger seat is occupied by a person of smaller stature (e.g. a teenager or small adult), the PASSENGER AIR BAG OFF indicator lamp either lights up continuously or remains off, depending on the classification.
  - If the PASSENGER AIR BAG OFF indicator lamp is off: move the front passenger seat as far back as possible, or the person of smaller stature should use a rear seat.

- If the PASSENGER AIR BAG OFF indicator lamp is lit continuously: the person of smaller stature should not use the front passenger seat.

**⚠ WARNING** Risk of injury or death when the PASSENGER AIR BAG OFF indicator lamp is lit

If the PASSENGER AIR BAG OFF indicator lamp remains lit after the self-test, the front passenger airbag is disabled.

If the front passenger seat is occupied, always ensure that:

- The classification of the person in the front passenger seat is correct and the front passenger airbag is enabled or disabled in accordance with the person in the front passenger seat.
- The person is seated properly with a correctly fastened seat belt.

Be sure to also observe the following further related subjects:

- Securing the child restraint system on the front passenger seat (→ page 61)

### PRE-SAFE® system

#### PRE-SAFE® (anticipatory occupant protection)

PRE-SAFE® is able to detect certain critical driving situations and implement pre-emptive measures to protect the vehicle occupants.

PRE-SAFE® can implement the following measures independently of each other:

- Tightening the seat belts on the driver's seat and front passenger seat.
- Closing the side windows.
- **Vehicles with sliding sunroof:** Close the sliding sunroof.
- **Vehicles with memory function:** Move the front passenger seat to a more favorable seat position.

- **Vehicles with multicontour seat:** Increase the air pressure in the seat side bolsters of the seat backrest.
- PRE-SAFE® Sound: provided that the multimedia system is switched on, generates a brief noise signal to stimulate the innate protective mechanism of a person's hearing.

**! NOTE** Damage caused by objects in the footwell or behind the seat

The automatic adjustment of the seat position may result in damage to the seat and/or the object.

▶ Stow objects in a suitable place.

#### Reversing the PRE-SAFE® system measures

If an accident did not occur, the pre-emptive measures that were taken are reversed.

You will need to perform certain settings yourself.

- ▶ If the seat belt pre-tensioning is not reduced, move the seat backrest back slightly. The locking mechanism releases.

### Function of PRE-SAFE® PLUS (anticipatory occupant protection plus)

PRE-SAFE® PLUS can detect certain impacts, particularly an imminent rear impact, and take pre-emptive measures to protect the vehicle occupants. These measures cannot necessarily prevent an imminent impact.

PRE-SAFE® PLUS can implement the following measures independently of each other:

- Tightening the seat belts on the driver's seat and front passenger seat.
- Increasing brake pressure when the vehicle is stationary. This brake application is canceled automatically when the vehicle pulls away.

If an accident did not occur, the pre-emptive measures that were taken are reversed.

### System limits

The system will not initiate any action in the following situations:

- when backing up  
or
- when the vehicle is towing a trailer and there is a risk of a rear impact

The system will not initiate any braking application in the following situations:

- whilst driving  
or
- when entering or exiting a parking space while using Active Parking Assist

### Function of PRE-SAFE® Impulse Side

If an imminent side impact is detected, PRE-SAFE® Impulse Side can pre-emptively move the front seat vehicle occupant's upper body towards the center of the vehicle. It does this by rapidly inflating an air cushion in the outer seat side bolster of the seat backrest on the side on which the impact is anticipated. This increases

the distance between the door and the vehicle occupant.

If PRE-SAFE® Impulse Side has been deployed or is faulty, the [PRE-SAFE Impulse Side Inoperative](#) See Operator's Manual display message appears (→ page 369).

### Automatic measures after an accident

Depending on the type and severity of the accident, and depending on the vehicle's equipment, the following measures can be implemented, for example:

- Automatic braking (post-collision brake)
- Activating the hazard warning lights
- Triggering an automatic emergency call (→ page 277)
- Switching off the engine

To restart the vehicle, switch the ignition off and switch it back on (→ page 144).

Depending on the type and severity of the accident, it is possible that the vehicle can no longer be started.

- Switching off the fuel supply
- Unlocking the vehicle doors
- Lowering the side windows
- Displaying the emergency guide in the multi-media system display
- Switching on the interior lighting

#### Function of the post-collision brake

Depending on the accident situation, the post-collision brake can minimize the severity of a further collision or even avoid it.

If an accident is detected, the post-collision brake can implement automatic braking. When the vehicle has come to a standstill, the electric parking brake is automatically applied.

The driver can cancel automatic braking by taking the following actions:

- Braking more strongly than automatic braking
- Fully depressing the accelerator pedal with force

### Safely transporting children in the vehicle

#### Always observe when children are traveling in the vehicle

- ⓘ Also strictly observe the safety notes for the specific situation. In this way you can recognize potential risks and avoid dangers if children are traveling in the vehicle (→ page 52).

#### Be diligent

Bear in mind that negligence when securing the child in the child restraint system may have serious consequences. Always be diligent in securing a child carefully before every journey.

To improve protection for children younger than twelve years old or under 5 ft (1.50 m) in height, Mercedes-Benz recommends you observe the following information:

- Always secure the child in a child restraint system suitable for this Mercedes-Benz vehicle.
- The child restraint system must be appropriate to the age, weight and size of the child.

- The vehicle seat must be suitable for installing a child restraint system.

Accident statistics show that children secured on the rear seats are generally safer than children secured on the front seats. For this reason, Mercedes-Benz strongly advises that you install a child restraint system on a rear seat.

#### The generic term child restraint system

The generic term child restraint system is used in this Operator's Manual. A child restraint system is, for example:

- a baby car seat
- a rearward-facing child seat
- a forward-facing child seat
- a child booster seat with a backrest and seat belt guide

Mercedes-Benz recommends using a child booster seat with a backrest.

The child restraint system must be appropriate to the age, weight and size of the child.

### **Observe laws and legal requirements**

Always observe the legal requirements when using a child restraint system in the vehicle.

### **Observe standards for child restraint systems**

All child restraint systems must meet the following standards:

- U.S. Federal Motor Vehicle Safety Standards 213 and 225
- Canadian Motor Vehicle Safety Standards 213 and 210.2

Confirmation that the child restraint system complies with the standards can be found on an instruction label on the child restraint system. This confirmation can also be found in the installation instructions that are included with the child restraint system.

### **Detecting risks, avoiding danger**

#### **Securing systems for child restraint systems in the vehicle**

Only use the following securing systems for child restraint systems:

- the LATCH-type (ISOFIX) mounting brackets
- the vehicle's seat belt system
- the Top Tether anchorages

Installing a LATCH-type (ISOFIX) child restraint system is preferred.

Simply attaching to the securing rings on the vehicle can reduce the risk of installing the child restraint system incorrectly.

When securing a child with the integrated seat belt of the LATCH-type (ISOFIX) child restraint system, always comply with the permissible gross weight for the child and child restraint system (→ page 56).

A booster seat may be necessary to achieve proper seat belt positioning for children over 40 lbs (18 kg) in weight or until they reach a

height where a three-point seat belt can be fastened properly without a booster seat.

Mercedes-Benz recommends a suitable child booster seat with a backrest and seat belt guide.

#### **Advantage of a rearward-facing child restraint system**

It is preferable to transport a baby or a small child in a suitable rearward-facing child restraint system. In this case, the child sits in the opposite direction to the direction of travel and faces backwards.

Babies and small children have comparatively weak neck muscles in relation to the size and weight of their head. The risk of injury to the cervical spine during an accident can be reduced in a rearward-facing child restraint system.



### Always secure a child restraint system correctly

**▲ WARNING** Risk of injury or death due to incorrect installation of the child restraint system

The child can then not be protected or restrained as intended.

- ▶ Be sure to comply with the manufacturer's installation instructions for the child restraint system and its correct use.
- ▶ Make sure that the entire base of the child restraint system always rests on the sitting surface of the seat.
- ▶ Never place objects (e.g. cushions) under or behind the child restraint system.
- ▶ Use child restraint systems only with the original cover designed for them.
- ▶ Always replace damaged covers with genuine covers.

**▲ WARNING** Risk of injury or death due to unsecured child restraint systems in the vehicle

If the child restraint system is incorrectly installed or not secured, it can come loose.

The child restraint system could be flung around and hit vehicle occupants.

- ▶ Always install child restraint systems correctly, even when not in use.
- ▶ Always comply with the child restraint system manufacturer's installation instructions.

- Always observe the child restraint system manufacturer's installation and operating instructions as well as the vehicle-specific information:
  - Installing the LATCH-type (ISOFIX) child restraint system on the rear seat (→ page 56).
  - Securing the child restraint system with the seat belt on the rear seat (→ page 59).

- Securing the child restraint system with the seat belt on the front passenger seat (→ page 61). Observe the specific instructions for the rearward-facing and forward-facing child restraint systems (→ page 61).

If the front passenger seat is occupied, ensure, both before and during the journey, that the status of the front passenger airbag is correct for the current situation (→ page 46).

- Observe the warning labels in the vehicle interior and on the child restraint system.
- Also secure Top Tether if present.

### Do not alter the child restraint system

**▲ WARNING** Risk of injury due to modifications to the child restraint system

The child restraint system can no longer function properly. This poses an increased risk of injury.

- ▶ Never modify a child restraint system.

- ▶ Only affix accessories which have been specially approved for this child restraint system by the child restraint system's manufacturer.

**Only use child restraint systems which are in proper working condition**

**▲ WARNING** Risk of injury or death caused by the use of damaged child restraint systems

Child restraint systems or their retaining systems that have been subjected to stress in an accident may not be able to perform their intended protective function.

It may be the case that the child cannot be properly restrained.

- ▶ Always immediately replace child restraint systems that have been damaged or involved in an accident.
- ▶ Have the securing systems for the child restraint systems checked at a qualified specialist workshop before installing a child restraint system again.

**Avoid direct sunlight**

**▲ WARNING** Risk of burns when the child seat is exposed to direct sunlight

If the child restraint system is exposed to direct sunlight or heat, parts could heat up. Children could suffer burns from these parts, particularly on the metallic parts of the child restraint system.

- ▶ Always make sure that the child restraint system is not exposed to direct sunlight.
- ▶ Protect the child restraint system with a blanket, for example.
- ▶ If the child restraint system has been exposed to direct sunlight, allow it to cool before securing a child into it.
- ▶ Never leave children unattended in the vehicle.

**Observe when stopping or parking**

**▲ WARNING** Risk of accident and injury due to children left unattended in the vehicle

If children are left unsupervised in the vehicle, they could, in particular:

- Open doors, thereby endangering other persons or road users.
- Get out and be struck by oncoming traffic.
- Operate vehicle equipment and become trapped, for example.

In addition, the children could also set the vehicle in motion, for example by:

- Releasing the parking brake.
  - Change the transmission position.
  - Start the vehicle.
- ▶ Never leave children unattended in the vehicle.

- ▶ When leaving the vehicle, always take the SmartKey with you and lock the vehicle.
- ▶ Keep the SmartKey out of reach of children.

**⚠ WARNING** Risk of fatal injury due to exposure to extreme heat or cold in the vehicle



If people – particularly children – are exposed to extreme temperatures over an extended period of time, there is a risk of serious or even fatal injury.

- ▶ Never leave anyone – particularly children – unattended in the vehicle.
- ▶ Never leave animals in the vehicle unattended.

### Overview of suitable seats in the vehicle for installing a child restraint system

#### Left/right rear seat

Preferred securing system:

-  LATCH-type (ISOFIX) child seat securing system
-  Also secure Top Tether if present (→ page 58)

Alternative securing system:

-  Vehicle seat belt

#### Front passenger seat

Securing system:

-  Vehicle seat belt



Be sure to observe:

- If the front passenger seat is occupied, ensure, both before and during the journey, that the status of the front passenger airbag is correct for the current situation (→ page 46).

- Observe the notes on automatic front passenger airbag shutoff (→ page 45)

#### Center rear seat

Securing system:

-  Vehicle seat belt
-  Also secure Top Tether if present (→ page 58)

### Activating or deactivating the child seat safety feature of the seat belt

**⚠ WARNING** Risk of injury or death if a seat belt is unfastened while the vehicle is in motion

If the seat belt is released while the vehicle is in motion, the child safety lock is deactivated and the child restraint system is no longer correctly secured. The seat belt is retracted slightly by the inertia reel and cannot be immediately fastened again.

- ▶ Stop the vehicle immediately in accordance with the traffic conditions.

- ▶ Activate the special seat belt retractor again and correctly secure the child restraint system.

When enabled, the child seat safety feature ensures that the seat belts of the front passenger seat and rear seats do not slacken once the child restraint system is secured.

The seat belts on the following seats are equipped with a child seat safety feature:

- Front passenger seat
- Rear seats

- ▶ **To install a child restraint system:** when installing a child restraint system, always observe the manufacturer's installation and operating instructions as well as the information in this Operator's Manual.
- ▶ Pull the seat belt smoothly from the seat belt outlet.
- ▶ Engage the seat belt tongue in the seat belt buckle.

- ▶ **To activate the child seat safety feature:** pull the seat belt out fully and let the inertia reel retract it again. When the child seat safety feature is activated, you will hear a ratcheting sound.
- ▶ Push the child restraint system down until the seat belt sits tightly.
- ▶ **To deactivate the child seat safety feature:** press the release button of the seat belt buckle.
- ▶ Hold the seat belt tongue and guide back to the seat belt outlet.

### Installing a LATCH-type (ISOFIX) child restraint system on the rear seat

### Installing a LATCH-type (ISOFIX) child restraint system on the rear seat

- ▲ **WARNING** Risk of accident if the rear bench seat, rear seat and seat backrest are not engaged

The rear bench seat, rear seat and seat backrest may fold forwards, even when you are driving.

- As a result, the vehicle occupant will be pushed into the seat belt with increased force. The seat belt will not be able to protect as intended and could cause additional injury.
- Objects or loads in the trunk or cargo compartment will not be restrained by the seat backrest.
- ▶ Make sure that the rear bench seat, the rear seat and the seat backrest are engaged before every trip.

If the rear seat backrest is not engaged and locked in place, the red lock verification indicator will be visible.

**⚠ WARNING** Risk of injury or death if the permissible gross mass of the child and child restraint system is exceeded

Too much load may be placed on the LATCH-type (ISOFIX) child seat securing systems and the child may not be restrained in the event of an accident, for example.

- ▶ If the child and the child restraint system together weigh more than the permissible gross mass of 73 lb (33 kg), use only a LATCH-type (ISOFIX) child restraint system that secures the child with the vehicle seat belt.
- ▶ Also secure the child restraint system with the Top Tether belt, if available.

Always comply with the information about the mass of the child restraint system:

- in the manufacturer's installation and operating instructions for the child restraint system used
- on a label on the child restraint system, if present

Regularly check that the permissible gross mass of the child and child restraint system is still complied with.

When installing a child restraint system, observe the following:

- ☑ Always observe the correct use of the seats and consider their suitability for attaching a child restraint system.
- ☑ Always comply with the manufacturer's installation and operating instructions for the child restraint system used.
- ☑ Make sure that the child's feet do not touch the front seat. If necessary, move the front seat slightly forwards.

 When installing a LATCH-type (ISOFIX) child restraint system, also observe the following:

- ☑ **When using a Group 0/0+ baby car seat and a Group I rearward-facing child restraint system on a rear seat:** adjust the front seat so that the seat does not touch the child restraint system.
- ☑ **When using a Group I forward-facing child restraint system:** remove the head restraint from the respective seat, if possible. In addition, the backrest of the child restraint system must lie as flat as possible against the backrest of the vehicle seat. After the child restraint system has been removed, replace the head restraint immediately and adjust all head restraints correctly.
- ☑ For certain child restraint systems in weight group II or III, there may be restrictions on the maximum size setting, e.g. due to possible contact with the roof.
- ☑ The child restraint system must not be installed between the roof and the seat

cushion and/or be installed facing the wrong direction. Where possible, adjust the seat cushion inclination accordingly.

- ✓ The child restraint system must not be put under strain by the head restraint. Adjust the head restraints accordingly.

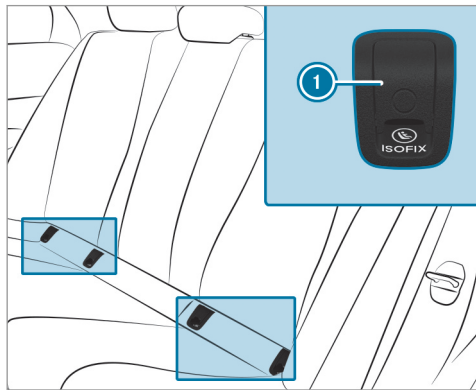

① LATCH-type (ISOFIX) mounting bracket

Before every journey, make sure that the LATCH-type (ISOFIX) child restraint system is engaged correctly in both mounting brackets in the vehicle.

**!** **NOTE** Damage to the seat belt for the center seat during installation of the child restraint system

▶ Make sure that the seat belt is not trapped.

- ▶ Remove and store away covers ①.
- ▶ Attach the LATCH-type (ISOFIX) child restraint system to both mounting brackets in the vehicle.
- ▶ After removing the child seat, reattach covers ①.

## Securing a Top Tether

**!** **WARNING** Risk of injury or death if the rear seat backrests are not locked after installing Top Tether belts

The rear seat backrests may fold forwards when driving.

In this case, child restraint systems may no longer perform their intended protective function. Additional injuries may also be caused.

- ▶ Always lock rear seat backrests after installing Top Tether belts.
- ▶ Pay attention to the lock verification indicator.

If the rear seat backrest is not engaged and locked in place, the red lock verification indicator will be visible.



If the child restraint system is equipped with a Top Tether belt:

The risk of injury can be reduced by a Top Tether. The Top Tether belt enables an additional connection between the child

restraint system attached with LATCH-type (ISOFIX) and the vehicle.

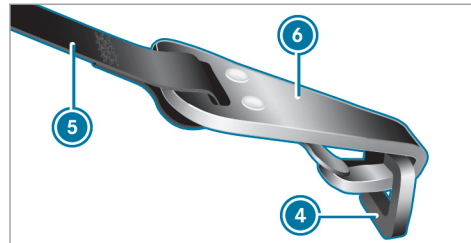
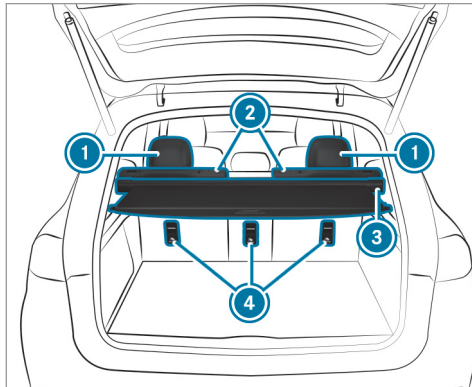

- ▶ If necessary, slide head restraint ① upwards (→ page 93).
- ▶ Install the LATCH-type (ISOFIX) child restraint system with Top Tether. Comply with the child restraint system manufacturer's installation instructions.
- ▶ Guide Top Tether belt ⑤ under head restraint ① between the two head restraint bars.
- ▶ If cargo compartment cover ③ is installed, guide Top Tether belt ⑤ downwards between cargo compartment cover ③ and seat backrest ②.

- ▶ Hook Top Tether hook ⑥ of Top Tether belt ⑤ into Top Tether anchorage ④ without twisting.
- ▶ Tension Top Tether belt ⑤. Comply with the child restraint system manufacturer's installation instructions.
- ▶ If necessary, slide head restraint ① downwards (→ page 93). Make sure that you do not interfere with the correct routing of Top Tether belt ⑤.

### Securing the child restraint system with the seat belt

#### Securing the child restraint system with the seat belt on the rear seat

**⚠ WARNING** Risk of accident if the rear bench seat, rear seat and seat backrest are not engaged

The rear bench seat, rear seat and seat backrest may fold forwards, even when you are driving.

- As a result, the vehicle occupant will be pushed into the seat belt with increased force. The seat belt will not be able to protect as intended and could cause additional injury.
- Objects or loads in the trunk or cargo compartment will not be restrained by the seat backrest.

▶ Make sure that the rear bench seat, the rear seat and the seat backrest are engaged before every trip.

If the rear seat backrest is not engaged and locked in place, the red lock verification indicator will be visible.

**When installing a belt-secured child restraint system, observe the following:**

- ✔ Always comply with the manufacturer's installation and operating instructions for the child restraint system used.
- ✔ **When using a category 0/0+ baby car seat and a category I rearward-facing child restraint system on a rear seat:**

adjust the front seat so that the seat does not touch the child restraint system.

- ✔ **When using a category I forward-facing child restraint system:** remove the head restraint from the respective seat, if possible.

After the child restraint system has been removed, replace the head restraint immediately and adjust all head restraints correctly.

- ✔ The backrest of the forward-facing child restraint system must, as far as possible, be resting on the seat backrest of the rear seat.
- ✔ For certain child restraint systems in weight category II or III, there may be restrictions on the maximum size setting, e.g. due to possible contact with the roof.
- ✔ The child restraint system must not be put under strain between the roof and the seat cushion and/or be installed facing the wrong direction. Where possible, adjust the seat cushion inclination accordingly.

- ✔ The child restraint system must not be put under strain by the head restraint. Adjust the head restraints accordingly.

- ✔ Make sure that the child's feet do not touch the front seat. If necessary, move the front seat slightly forwards.

The seat belts on the following seats are equipped with a special seat belt retractor:

- Front passenger seat
- Rear seats

When enabled, the special seat belt retractor ensures that the seat belts of the front passenger seat and rear seats do not slacken once the child restraint system is secured (→ page 55).

- ▶ Install the child restraint system. The entire base of the child restraint system must always rest on the sitting surface of the rear seat.
- ▶ Always make sure that the shoulder belt strap is correctly routed from the seat belt



outlet of the vehicle to the shoulder belt guide on the child restraint system. The shoulder belt strap must be routed forwards and downwards from the seat belt outlet.

### Notes on rearward-facing and forward-facing child restraint systems on the front passenger seat

**⚠ WARNING** Risk of injury or death when using a rearward-facing child restraint system while the front passenger airbag is enabled

If you secure a child in a rearward-facing child restraint system on the front passenger seat and the PASSENGER AIR BAG OFF indicator lamp is off, the front passenger airbag can deploy in the event of an accident.

The child could be struck by the airbag.

Always ensure that the front passenger airbag is disabled. The PASSENGER AIR BAG OFF indicator lamp must be lit.

NEVER use a rearward-facing child restraint system on a seat with an ENABLED FRONT AIRBAG; DEATH or SERIOUS INJURY to the CHILD can occur.

Observe the specific instructions for rearward-facing and forward-facing child restraint systems (→ page 61).

Always observe the status of the front passenger airbag on the PASSENGER AIR BAG OFF indicator lamp:

- When using a rearward-facing child restraint system on the front passenger seat, the front passenger airbag must always be disabled. This is only the case if the PASSENGER AIR BAG OFF indicator lamp is lit continuously (→ page 46).
- If the PASSENGER AIR BAG OFF indicator lamp is off, the front passenger airbag is enabled. The front passenger airbag may deploy during an accident.

### Securing the child restraint system with the seat belt on the front passenger seat

When installing a belt-secured child restraint system on the front passenger seat, always observe the following:

- ✓ Observe the child restraint system manufacturer's installation and operating instructions.
- ✓ When using a forward-facing child restraint system in category I: remove the head restraint from the respective seat, if possible.
 

After the child restraint system has been removed, replace the head restraint immediately and adjust all head restraints correctly.
- ✓ The backrest of the forward-facing child restraint system must, as far as possible, be resting on the seat backrest of the front passenger seat.
- ✓ For certain child restraint systems in weight category II or III, there may be restrictions on the maximum size setting, e.g. due to possible contact with the roof.

## 62 Occupant safety

- ✓ The child restraint system must not be put under strain between the roof and the seat cushion and/or be installed facing the wrong direction.
- ✓ The child restraint system must not be put under strain by the head restraint. Adjust the head restraints accordingly.
- ✓ Never place objects (e.g. cushions) under or behind the child restraint system.

The seat belt on the front passenger side is equipped with a child seat safety feature.

When enabled, the child seat safety feature ensures that the seat belt does not slacken once the child seat is secured (→ page 55).

- ▶ Set the front passenger seat as far back as possible and move the seat into the highest position if possible.
- ▶ Fully retract the seat cushion length adjustment.
- ▶ Adjust the seat cushion inclination so that the front edge of the seat cushion is in the highest position and the rear edge of the seat cushion is in the lowest position.

- ▶ Set the seat backrest to the most vertical position possible.
- ▶ Install the child restraint system. The entire base of the child restraint system must always rest on the sitting surface of the front passenger seat.
- ▶ Always make sure that the shoulder belt strap is correctly routed from the seat belt outlet of the vehicle to the shoulder belt guide on the child restraint system. The shoulder belt strap must be routed forwards and downwards from the seat belt outlet.
- ▶ If necessary, adjust the seat belt outlet and the front passenger seat accordingly.

### Child safety locks

#### Activating or deactivating the child safety lock for the rear doors

**⚠ WARNING** Risk of accident and injury due to children left unattended in the vehicle

If children are left unsupervised in the vehicle, they could, in particular:

- Open doors, thereby endangering other persons or road users.
- Get out and be struck by oncoming traffic.
- Operate vehicle equipment and become trapped, for example.

In addition, the children could also set the vehicle in motion, for example by:

- Releasing the parking brake.
- Change the transmission position.
- Start the vehicle.

- ▶ Never leave children unattended in the vehicle.
- ▶ When leaving the vehicle, always take the SmartKey with you and lock the vehicle.
- ▶ Keep the SmartKey out of reach of children.

**⚠ WARNING** Risk of fatal injury due to exposure to extreme heat or cold in the vehicle

If people – particularly children – are exposed to extreme temperatures over an extended period of time, there is a risk of serious or even fatal injury.

- ▶ Never leave anyone – particularly children – unattended in the vehicle.
- ▶ Never leave animals in the vehicle unattended.

**⚠ WARNING** Risk of accident and injury due to children left unattended in the vehicle

If children are traveling in the vehicle, they could, in particular:

- Open doors, thereby endangering other persons or road users
  - Get out and be struck by oncoming traffic
  - Operate vehicle equipment and become trapped, for example
- ▶ Always activate the child safety locks installed if children are traveling in the vehicle.
  - ▶ Never leave children unattended in the vehicle.
  - ▶ When leaving the vehicle, always take the SmartKey with you and lock the vehicle.

There are child safety locks for the rear doors and the rear side windows.

The child safety lock on the rear doors secures each door separately. The doors can no longer be opened from the inside.

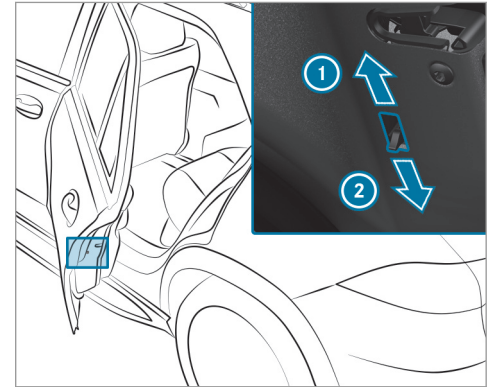

- ▶ Press the lever in direction ① (activate) or ② (deactivate).
- ▶ Make sure that the child safety locks are working properly.

### Activating or deactivating the child safety lock for the rear side windows

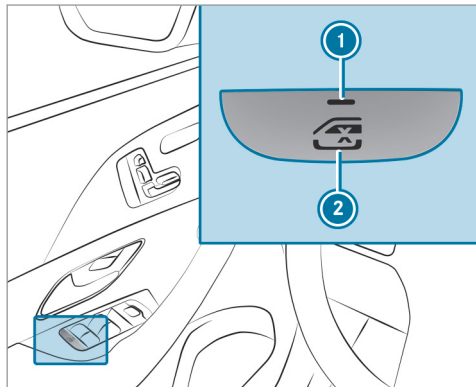

▶ **To activate/deactivate:** press button ②.

The rear side window can be opened or closed in the following cases:

- indicator lamp ① is lit: via the switch on the driver's door

- Indicator lamp ① is off: via the switch on the corresponding rear door or driver's door.

### Notes on pets in the vehicle

**⚠ WARNING** Risk of accident and injury due to animals left unsecured or unattended in the vehicle

If you leave animals in the vehicle unattended or unsecured, they could possibly press down buttons or switches.

Thereby an animal may:

- activate vehicle equipment and become trapped, for example
- switch systems on or off and endanger other road users

Unsecured animals may be thrown around in the vehicle in the event of an accident or sudden steering and braking maneuver and injure vehicle occupants in the process.

- ▶ Never leave animals in the vehicle unattended.
- ▶ Always correctly secure animals while driving, for example using a suitable animal carrier.

## SmartKey

### Overview of SmartKey functions

**⚠ WARNING** Risk of accident and injury due to children left unattended in the vehicle

If children are left unsupervised in the vehicle, they could, in particular:

- Open doors, thereby endangering other persons or road users.
- Get out and be struck by oncoming traffic.
- Operate vehicle equipment and become trapped, for example.

In addition, the children could also set the vehicle in motion, for example by:

- Releasing the parking brake.
- Change the transmission position.
- Start the vehicle.

▶ Never leave children unattended in the vehicle.

- ▶ When leaving the vehicle, always take the SmartKey with you and lock the vehicle.
- ▶ Keep the SmartKey out of reach of children.

**❗ NOTE** Damage to the SmartKey caused by magnetic fields

- ▶ Keep the SmartKey away from strong magnetic fields.

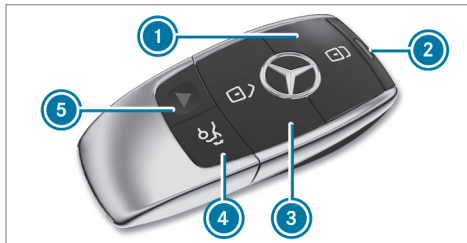

- ① Locks
- ② Indicator lamp

- ③ Unlocks
  - ④ Opens/closes the tailgate
  - ⑤ Panic alarm
- ❖ If indicator lamp ② does not light up after pressing the or button, the battery is discharged.

Replacing the SmartKey battery (→ page 67).

The SmartKey locks and unlocks the following components:

- the doors
- the fuel filler flap
- the tailgate

If the vehicle is not opened within approximately 40 seconds after unlocking, it locks again. Anti-theft protection is armed again.

Do not keep the SmartKey together with electronic devices or metal objects. This can affect the SmartKey's functionality.

Do not keep the SmartKey in the temperature-controlled cup holder. Otherwise, the SmartKey will not be reliably detected.

### Activating/deactivating the acoustic locking verification signal

Multimedia system:

→  ▶ Settings ▶ Vehicle

- ▶ Activate or deactivate **Acoustic Lock**.

### Activating/deactivating the panic alarm

#### Requirements:

- The ignition is switched off.





- ▶ **To activate:** press button ① for approximately one second.  
A visual and audible alarm is triggered.

- ▶ **To deactivate:** briefly press button ① again.  
or
- ▶ Press the start/stop button on the cockpit (the SmartKey is inside the vehicle).

### Changing the unlocking settings

Possible unlocking functions of the SmartKey:

- Central unlocking
- Unlocking the driver's door and fuel filler flap

- ▶ **To switch between settings:** press the  and  buttons simultaneously for approximately six seconds until the indicator lamp flashes twice.

Options if the unlocking function for the driver's door and fuel filler flap has been selected:

- **To unlock the vehicle centrally:** press the  button twice.
- **Vehicles with KEYLESS-GO:** if you touch the inner surface of the door handle on the driver's door, only the driver's door and fuel filler flap are unlocked.

### Deactivating the SmartKey functions

If you do not use the vehicle or a SmartKey for an extended period of time, you can reduce the energy consumption of the respective SmartKey. To do so, deactivate the SmartKey functions.

- ▶ **To deactivate:** press the  button on the SmartKey twice in quick succession. The SmartKey indicator lamp flashes twice briefly and lights up once.
- ▶ **To activate:** press any button on the SmartKey.

- ① When the vehicle is started with the SmartKey in the marked space of the center console, the SmartKey functions are automatically activated (→ page 144).

### Removing/inserting the emergency key

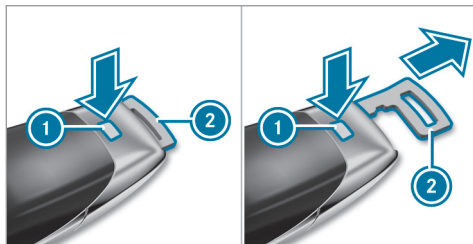

- ▶ **To remove:** press release knob ①. Emergency key ② is pushed out slightly.
  - ▶ Pull out emergency key ② until it engages in the intermediate position.
  - ▶ Press release knob ① again and fully remove emergency key ②.
  - ▶ **To insert:** press release knob ①.
  - ▶ Insert emergency key ② to the intermediate position or fully until it engages.
- ① You can use the intermediate position of emergency key ② to attach the SmartKey to a key ring.

### Replacing the SmartKey battery

**⚠ DANGER** Serious damage to health caused by swallowing batteries

Batteries contain toxic and corrosive substances. Swallowing batteries may cause serious damage to health.

There is a risk of fatal injury.

- ▶ Keep batteries out of the reach of children.
- ▶ If batteries are swallowed, seek medical attention immediately.

**🔥 ENVIRONMENTAL NOTE** Environmental damage caused by improper disposal of batteries



Batteries contain pollutants. It is illegal to dispose of them with the household rubbish.



Dispose of batteries in an environmentally responsible manner. Take discharged batteries to a qualified specialist workshop or to a collection point for used batteries.

#### Requirements:

- You require a CR 2032 3 V cell battery.

Mercedes-Benz recommends that you have the battery replaced at a qualified specialist workshop.

- ▶ Remove the emergency key (→ page 67).

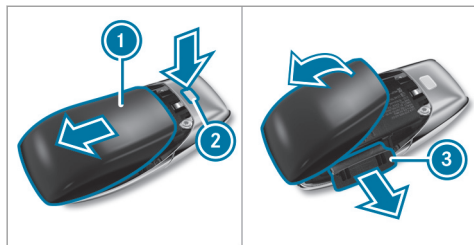

- ▶ Press release knob ② down fully and slide cover ① in the direction of the arrow.
- ▶ Fold out cover ① in the direction of the arrow and remove.
- ▶ Remove battery compartment ③ and take out the discharged battery.
- ▶ Insert the new battery into battery compartment ③. Observe the positive pole marking in the battery compartment and on the battery when doing this.
- ▶ Push in battery compartment ③.
- ▶ Re-attach cover ① and push it until it engages.

### Problems with the SmartKey

#### You can no longer lock or unlock the vehicle

Possible causes:

- The SmartKey battery is weak or discharged.
  - The SmartKey is faulty.
- ▶ Check the battery using the indicator lamp and replace if necessary (→ page 67).
  - ▶ Use the emergency key to lock or unlock (→ page 67).
  - ▶ Have the SmartKey checked at a qualified specialist workshop.

#### There is interference from a powerful radio signal source

The SmartKey function is impaired by, for example:

- High voltage power lines
- Mobile phones
- Electronic devices (notebooks, Tablets)
- Shielding due to metal objects or induction loops for electrical gate systems or automatic barriers

- ▶ Make sure that there is a sufficient distance between the SmartKey and the potential source of interference.

#### You have lost a SmartKey

- ▶ Have the SmartKey deactivated at a qualified specialist workshop.
- ▶ If necessary, have the mechanical lock replaced as well.

### Doors

#### Unlocking and opening doors from the inside

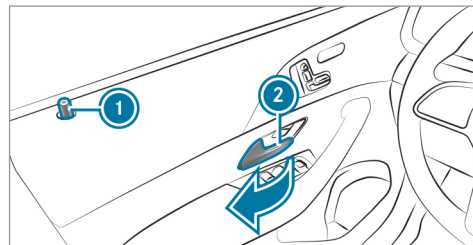



- ▶ **To unlock and open a front door:** pull door handle ②. Locking pin ① pops up when the door is unlocked.
- ▶ **To unlock a rear door:** pull the rear door handle. The locking pin pops up when the rear door is unlocked.
- ▶ **To open a rear door:** pull the rear door handle again.

### Centrally locking and unlocking the vehicle from the inside

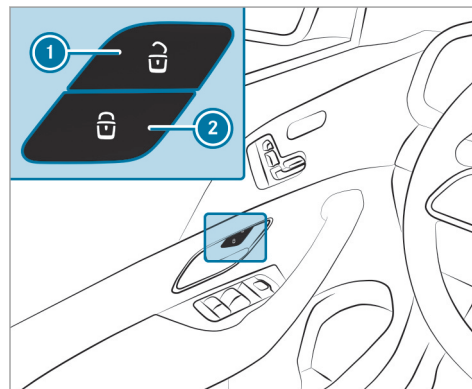

- ▶ **To unlock:** press button ①.
- ▶ **To lock:** press button ②.

This does not lock or unlock the fuel filler flap.

The vehicle is not unlocked:

- If you have locked the vehicle using the SmartKey.
- If you have locked the vehicle using KEY-LESS-GO.

### Locking/unlocking the vehicle with KEY-LESS-GO

#### Requirements:

- The SmartKey is outside the vehicle.
- The distance between the SmartKey and the vehicle does not exceed 3 ft (1 m).
- The driver's door and the door at which the door handle is used are closed.

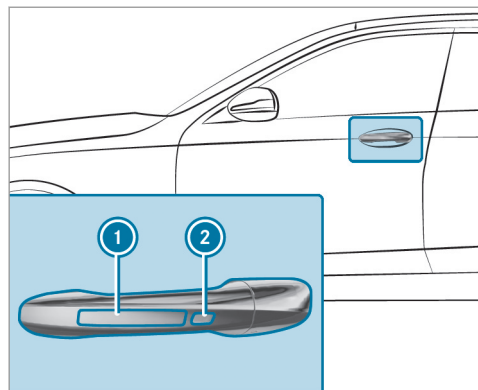

- ▶ **To unlock the vehicle:** touch the inner surface of the door handle.
- ▶ **To lock the vehicle:** touch sensor surface ① or ②.
- ▶ **Convenience closing:** touch recessed sensor surface ② until the closing process has been completed.

① Further information on convenience closing (→ page 79).

If you open the tailgate from outside, it is automatically unlocked.

### Problems with KEYLESS-GO

**You can no longer lock or unlock the vehicle using KEYLESS-GO.**

Possible causes:

- The SmartKey functions have been deactivated (→ page 66).
  - The SmartKey battery is weak or discharged.
  - The SmartKey is faulty.
- ▶ Activate the SmartKey functions (→ page 66).
  - ▶ Check the battery using the indicator lamp and replace if necessary (→ page 67).
  - ▶ Use the emergency key to unlock or lock the vehicle (→ page 67).
  - ▶ Have the vehicle and SmartKey checked at a qualified specialist workshop.

**There is interference from a powerful radio signal source**

The KEYLESS-GO function is impaired by, for example:

- High voltage power lines
- Mobile phones
- Electronic devices (notebooks, tablets)
- Shielding due to metal objects or induction loops for electrical gate systems or automatic barriers

▶ Make sure that there is a sufficient distance between the SmartKey and the potential source of interference.

### Activating/deactivating the automatic locking feature

The vehicle is locked automatically when the ignition is switched on and the wheels are turning faster than walking pace.

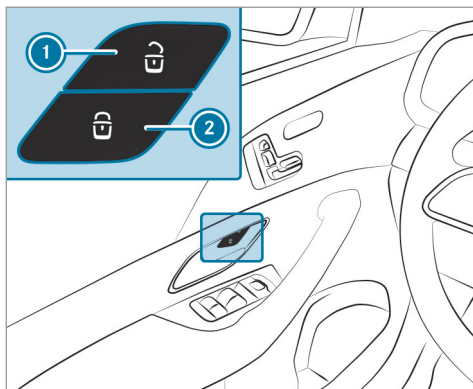

- ▶ **To activate:** press and hold button ② for approximately five seconds until an acoustic signal sounds.
- ▶ **To deactivate:** press and hold button ① for approximately five seconds until an acoustic signal sounds.

In the following situations, there is a danger of being locked out when the function is activated:

- While the vehicle is being tow started/ pushed.
- If the vehicle is being tested on a roller dynamometer.

#### Power closing function

**⚠ WARNING** Risk of becoming trapped when the doors close automatically

Body parts or objects can become trapped, causing injuries.

- ▶ Ensure that no body parts or objects are in the closing area.
- ▶ Automatic closing of the doors can be canceled by pulling the outer or inner door handle.

If you push the door into the lock to the first detent position, the power closing function will automatically pull the door into the lock.

#### Locking/unlocking the driver's door with the emergency key

- ① If you wish to lock the vehicle entirely using the emergency key, first press the button for locking from the inside while the driver's door is open. Then proceed to lock the driver's door using the emergency key.

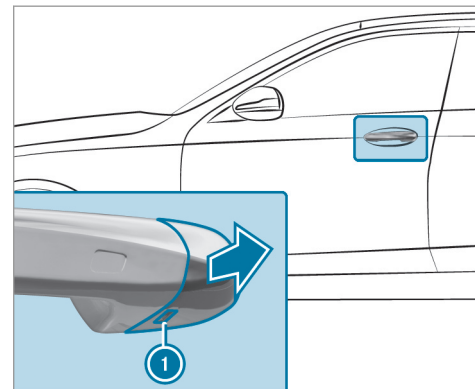

- ▶ Insert the emergency key as far as it will go into opening 1 in the cover.
- ▶ Pull and hold the door handle.
- ▶ Pull the cover on the emergency key as straight as possible away from the vehicle until it releases.
- ▶ Release the door handle.

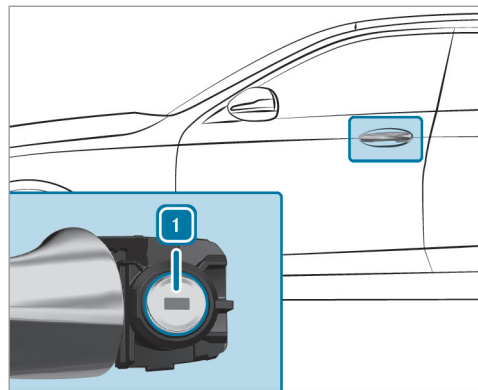

- ▶ **To unlock:** turn the emergency key counter-clockwise to position 1.
- ▶ **To lock:** turn the emergency key clockwise to position 1.
- ▶ Carefully press the cover onto the lock cylinder until it engages and is seated firmly.

### Cargo compartment

#### Opening the tailgate

**⚠ DANGER** Risk of exhaust gas poisoning

Combustion engines emit poisonous exhaust gases such as carbon monoxide. Exhaust gases can enter the vehicle interior if the tailgate is open when the engine is running, especially if the vehicle is in motion.

- ▶ Always switch off the engine before opening the tailgate.
- ▶ Never drive with the tailgate open.

**!** **NOTE** Damage to the tailgate caused by obstacles above the vehicle

The tailgate swings rearwards and upwards when it is opened.

- ▶ Make sure that there is sufficient space behind and above the tailgate.

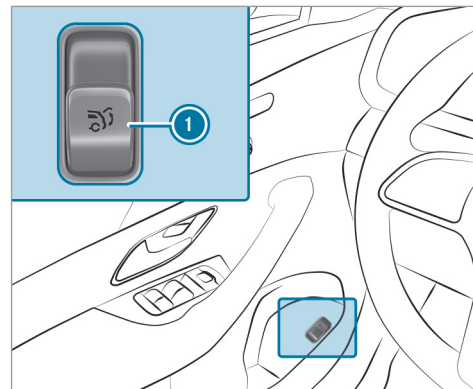

- ▶ Pull remote operating switch ① for the tailgate.
- ▶ Press and hold the  button on the SmartKey.
- ▶ **Vehicles with HANDS-FREE ACCESS:** Use your foot to kick below the bumper (→ page 75).
- ▶ If the tailgate is unlocked, pull the tailgate handle and release it.
- ▶ For a tailgate stopped in an intermediate position, pull it upwards and release it as soon as it starts to open.

The tailgate is equipped with an automatic object recognition function. If a solid object blocks or restricts the tailgate during automatic opening, this process will be stopped. The automatic object recognition function is only an aid. It is not a substitute for your attentiveness when you are opening the tailgate.

### Closing the tailgate

**▲ WARNING** Risk of injury from unsecured items in the vehicle

If objects, luggage or loads are not secured or not secured sufficiently, they could slip, tip over or be thrown around and thereby hit vehicle occupants.

There is a risk of injury, particularly in the event of sudden braking or a sudden change in direction.

- ▶ Always stow objects in such a way that they cannot be thrown around.
- ▶ Before the journey, secure objects, luggage or loads against slipping or tipping over.

Observe the notes on loading the vehicle.

- ▶ Pull the tailgate downwards slightly. Release it as soon as it begins to close.

**▲ WARNING** Risk of becoming trapped during automatic closing of the tailgate

Body parts may become trapped. There may be people in the closing area.

- ▶ Make sure that nobody is in the vicinity of the closing area during the closing process.

Use one of the following options to stop the closing process:

- Press the  button on the SmartKey.
- Press or pull the remote operating switch on the driver's door.
- Press the closing or locking button on the tailgate.
- Pull the tailgate handle.

- ▶ **Vehicles with HANDS-FREE ACCESS:** it is also possible to stop the closing process by making a kicking movement below the rear bumper.

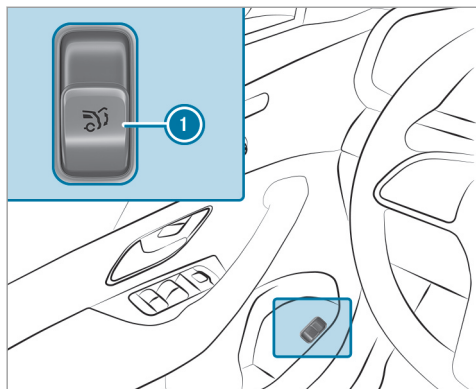

- ▶ Switch on the power supply or the ignition.
- ▶ Press remote operating switch ① for the tailgate.

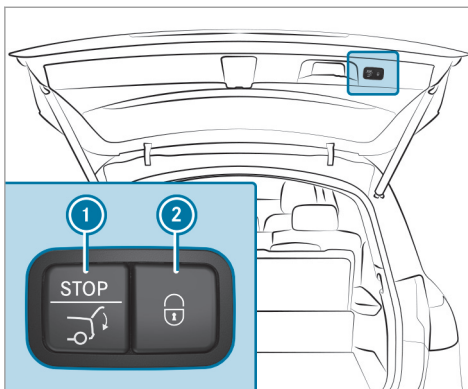

- ▶ Press closing button ① on the tailgate.

#### Vehicles with KEYLESS-GO

- ▶ Press locking button ② on the tailgate. If a SmartKey is detected outside the vehicle, the tailgate will close and the vehicle will be locked.

- ▶ Press and hold the  button on the SmartKey (with the SmartKey in the vicinity of the vehicle).

#### Vehicles with HANDS-FREE ACCESS

- ▶ Make a kicking movement with your foot below the bumper (→ page 75).

#### Automatic reversing function for the tailgate

The tailgate is equipped with automatic object recognition with a reversing function. If a solid object hinders or restricts the tailgate when it is closing automatically, the tailgate will automatically open again slightly. Automatic object recognition with reversing function is only an aid. It is not a substitute for your attentiveness when you are closing the tailgate.

- ▶ During the closing process, make sure that no body parts are in the closing area.

**⚠ WARNING** Risk of becoming trapped despite reversing function

The reversing function will not react:

- To soft, light and thin objects, e.g. fingers

- Towards the end of the closing procedure

In these situations in particular, the reversing function cannot prevent someone being trapped.

- ▶ Ensure that no body parts are in the closing area.

If someone is trapped, either:

- Press the  button on the SmartKey.
- Press or pull the remote operating switch on the driver's door.
- Press the closing or locking button on the tailgate.
- Pull the tailgate handle.

### HANDS-FREE ACCESS function

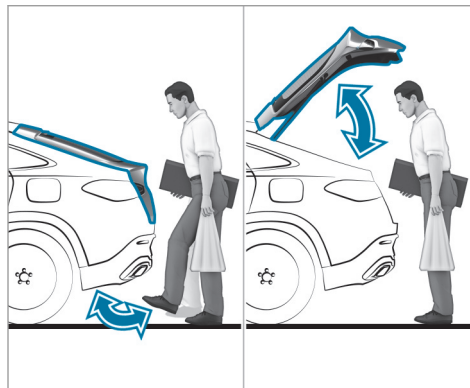

With HANDS-FREE ACCESS you can open, close or stop the closing process of the tailgate by performing a kicking movement under the rear bumper.

The kicking movement triggers the opening or closing process alternately.

Observe the notes when opening (→ page 72) and closing (→ page 73) the tailgate.

- ⓘ Two warning tones sound when the tailgate is opening or closing.

**⚠ WARNING** Risk of burns caused by a hot exhaust system

The vehicle exhaust system can become very hot. If you use HANDS-FREE ACCESS, you could burn yourself by touching the exhaust system.

- ▶ Always ensure that you only make a kicking movement within the detection range of the sensors.

**!** **NOTE** Vehicle damage due to unintentional opening of the tailgate

- when using an automatic car wash
- when using a high pressure cleaner
- ▶ Deactivate KEYLESS-GO or make sure that the key located is at least 10 ft

(3 m) away from the vehicle in such situations.

When making the kicking movement, make sure that you are standing firmly on the ground. You could otherwise lose your balance, e.g. on ice.

Observe the following notes:

- The SmartKey is behind the vehicle.
- Stand at least 12 in (30 cm) away from the vehicle while performing the kicking movement.
- Do not come into contact with the bumper while making the kicking movement.
- Do not carry out the kicking movement too slowly.
- The kicking movement must be towards the vehicle and back again.

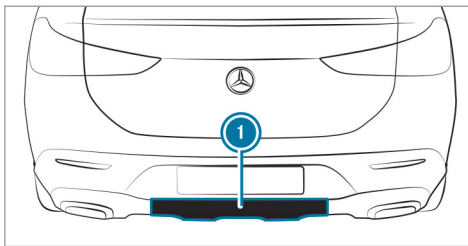

### ① Detection range of the sensors

If several consecutive kicking movements are not successful, wait ten seconds.

### System limits

The system may be impaired or may not function in the following cases:

- The sensors are dirty, e.g. due to road salt or snow.
- The kicking movement is made using a prosthetic leg.

The tailgate can open or close unintentionally in the following situations:

- If a person's arms or legs are moving in the sensor detection range, e.g. when polishing the vehicle or picking up objects.
- If objects are moved or placed behind the vehicle, e.g. tensioning straps or luggage.
- If clamping straps, tarps or other coverings are pulled over the bumper.
- If a protective mat with a length reaching over the trunk sill down into the detection range of the sensors is used.
- If the protective mat is not secured correctly.
- When working on the trailer hitch, trailers or rear bicycle racks.

Deactivate the SmartKey functions (→ page 66) or do not carry the SmartKey about your person in such situations.



### Limiting the opening angle of the tailgate

#### Activating the opening angle limiter

You can limit the opening angle of the tailgate in the top half of its opening range to approximately 8 in (20 cm) before the end position.

- ▶ Stop the opening procedure of the tailgate at the desired position.
- ▶ Press and hold the closing button on the tailgate until you hear a short acoustic signal. The opening angle limiter will be activated. The tailgate will then stop in the stored position when opened.

To open the tailgate fully, pull the handle on the outside of the tailgate again after it has stopped automatically.

#### Deactivating the opening angle limiter

- ▶ Press and hold the closing button on the tailgate until two short acoustic signals sound.

### Unlocking the tailgate with the emergency key

#### Requirements:

- The rear seat backrest has been folded forward.
- The collapsible cargo compartment cover has been removed.

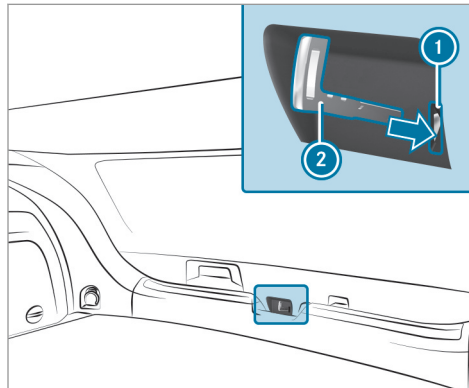

- ▶ Insert emergency key ② into opening ① in the trim and push it in. The tailgate will be unlocked.

### Side windows

#### Opening and closing the side windows

**⚠ WARNING** Risk of entrapment when opening a side window

When opening a side window, parts of the body could be drawn in or become trapped between the side window and window frame.

- ▶ When opening, make sure that nobody is touching the side window.
- ▶ If someone is trapped, release the button immediately or pull it in order to close the side window again.

**⚠ WARNING** Risk of becoming trapped when closing a side window

When closing a side window, body parts could be trapped in the closing area in the process.

- ▶ When closing, make sure that no body parts are in the closing area.

- ▶ If someone is trapped, release the button immediately or press the button in order to reopen the side window.

**⚠ WARNING** Risk of becoming trapped when children operate the side windows

Children could become trapped if they operate the side windows, particularly when unattended.

- ▶ Activate the child safety lock for the rear passenger compartment side windows.
- ▶ When leaving the vehicle, always take the SmartKey with you and lock the vehicle.
- ▶ Never leave children unattended in the vehicle.

**Requirements:**

- The power supply or the ignition is switched on.

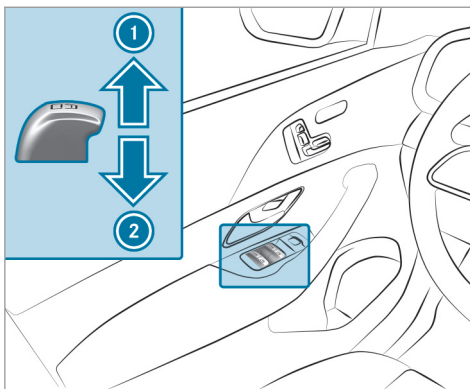

- ① Closes
- ② Opens

The buttons on the driver's door take precedence.

- ▶ **To start automatic operation:** press the  button beyond the point of resistance or pull and release it.

- ▶ **To interrupt automatic operation:** press or pull the  button again.

When the vehicle is switched off, the side windows can continue being operated.

This function is available for around four minutes or until a front door is opened.

**Automatic reversing function of the side windows**

If an object impedes a side window during the closing process, the side window will open again automatically. The automatic reversing function is only an aid and is not a substitute for your attentiveness.

- ▶ During the closing process, make sure that no body parts are in the closing area.

**⚠ WARNING** Risk of becoming trapped despite there being reversing protection on the side window

The reversing function does not react:

- To soft, light and thin objects, e.g. fingers.

- During resetting.

The reversing function cannot prevent someone from becoming trapped in these situations.

- ▶ During the closing process, make sure that no body parts are in the closing area.
- ▶ If someone becomes trapped, press the  button to open the side window again.

### Convenience opening (ventilating the vehicle before starting a journey)

**⚠ WARNING** Risk of entrapment when opening a side window

When opening a side window, parts of the body could be drawn in or become trapped between the side window and window frame.

- ▶ When opening, make sure that nobody is touching the side window.

- ▶ Release the button immediately if somebody becomes trapped.

- ▶ Press and hold the  button on the SmartKey.

The following functions are performed:

- The vehicle is unlocked.
- The side windows are opened.
- The panoramic sliding roof is opened.
- The seat ventilation of the driver's seat is switched on.

- ⓘ If the roller sunblind of the panoramic sliding sunroof is closed, the roller sunblind is opened first.

- ▶ **To interrupt convenience opening:** release the  button.

- ▶ **To continue convenience opening:** press and hold the  button again.

### Convenience closing (closing the vehicle from outside)

**⚠ WARNING** Risk of entrapment due to not paying attention during convenience closing



When the convenience closing feature is operating, parts of the body could become trapped in the closing area of the side window and the sliding sunroof.

- ▶ When the convenience closing feature is operating, monitor the entire closing process and make sure that no body parts are in the closing area.

- ▶ Press and hold the  button on the SmartKey.

The following functions are performed:

- The vehicle is locked.
- The side windows are closed.
- The panoramic sliding roof is closed.

- ▶ **To interrupt convenience closing:** release the  button.
- ▶ **To close the roller sunblinds:** press and hold the  button again.
- ⓘ Convenience closing can also be operated with KEYLESS-GO (→ page 69).

### Problems with the side windows

**⚠ WARNING** Risk of becoming trapped or fatally injured if reversing protection is not activated

If you close a side window again immediately after it has been blocked, the side window will close with increased or maximum force. The reversing function is then not active and body parts may become trapped.

- ▶ Make sure that no parts of the body are in the closing area.
- ▶ To stop the closing process, release the button or press the button again to reopen the side window.

**A side window cannot be closed and you cannot see the cause.**

- ▶ Check to see whether any objects are in the window guide.
- ▶ Adjust the side windows.

### Adjusting the side windows

If a side window is obstructed during closing and reopens again immediately:

- ▶ Immediately after this, pull the corresponding button again until the side window has closed and hold the button for at least one more second (re-adjustment). The side window will be closed without the automatic reversing function.

If the side window is obstructed again and reopens again immediately:

- ▶ Immediately after this, pull the corresponding button again until the side window has closed and hold the button for at least one more second (follow-up adjustment). The side window will be closed without the automatic reversing function.

**The side windows cannot be opened or closed using the convenience opening feature.**

- The SmartKey battery is weak or discharged.
- ▶ Check the battery using the indicator lamp and replace if necessary (→ page 67).

### Sliding sunroof

#### Opening and closing the sliding sunroof

- ⓘ The term "sliding sunroof" also refers to the panorama roof with power tilt/sliding panel.

**⚠ WARNING** Risk of becoming trapped when the sliding sunroof is being opened and closed

Body parts may become trapped in the range of movement.

- ▶ During opening and closing, make sure that no body parts are in the range of movement.
- ▶ Release the button immediately if somebody becomes trapped.

or

- ▶ Briefly press the button in any direction during automatic operation. The opening or closing process will be stopped.

**⚠ WARNING** Risk of becoming trapped if the sliding sunroof is operated by children

Children operating the sliding sunroof could get caught in the moving parts, particularly if unattended.

- ▶ Never leave children unattended in the vehicle.
- ▶ When leaving the vehicle, always take the key with you and lock the vehicle.

**⚠ WARNING** Risk of becoming trapped when the roller sunblind is being opened and closed

Body parts may become trapped between the roller sunblind and frame or sliding roof.

- ▶ When opening or closing, make sure that no body parts are in the roller sunblind's range of movement.
- ▶ Release the button immediately if somebody becomes trapped.

or

- ▶ Briefly press the button in any direction during automatic operation. The opening or closing process will be stopped.

**! NOTE** Malfunction due to snow and ice

Snow and ice may cause the sliding sunroof to malfunction.

- ▶ Open the sliding sunroof only if it is free of snow and ice.

**! NOTE** Damage caused by protruding objects

Objects that protrude from the sliding sunroof may damage the sealing strips.

- ▶ Do not allow anything to protrude from the sliding sunroof.

**! NOTE** Important points to remember when a roof luggage rack is installed

When a roof luggage rack is installed, raising or opening the sliding sunroof may be limited.

- ▶ Check whether the sliding sunroof can be raised or opened when a roof luggage rack is installed.
- ▶ If in doubt, do not raise or open the sliding sunroof.

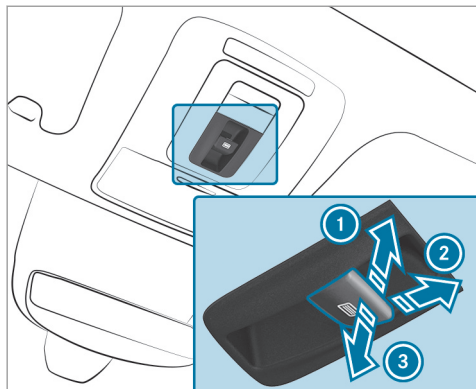

- ① To raise
- ② To open
- ③ To close/lower

Use the  button to operate the panorama roof with power tilt/sliding panel and the roller sunblind.

The panorama roof with power tilt/sliding panel can be operated only when the roller sunblind is open.

❶ The roller sunblind can be opened only when the panorama roof with power tilt/sliding panel is closed or in the raised position.

▶ Check whether the sliding sunroof can be raised or opened when a roof luggage rack is installed.

▶ **To start automatic operation:** press the  button beyond the point of resistance or pull and release it.

▶ **To interrupt automatic operation:** briefly press the  button in any direction. The opening/closing process will be stopped.

**Vehicles with a panorama roof with power tilt/sliding panel:** The automatic raising feature is available only when the sliding sunroof is closed or raised.

▶ **To ventilate the vehicle interior:** raise the sliding sunroof. The roller sunblind will open slightly.

### Automatic reversing function of the sliding sunroof

If an object is obstructing the sliding sunroof during the closing process, the sliding sunroof will open again automatically. The automatic reversing function is only an aid and is not a substitute for your attentiveness.

▶ During the closing process, make sure that no body parts are in the closing area.

**⚠ WARNING** Risk of becoming trapped despite the reversing function being active

In particular, the reversing function does not react:

- To soft, light and thin objects, e.g. fingers.
- Towards the end of the closing procedure.
- During resetting.

▶ During the closing process, make sure that no body parts are in the closing area.

- ▶ Release the button immediately if somebody becomes trapped.

or

- ▶ Briefly press the button in any direction during automatic operation. The closing process will be stopped.

#### Automatic reversing function of the roller sunblind

If an object is obstructing the roller sunblind during the closing process, the roller sunblind will open again automatically. The automatic reversing function is only an aid and is not a substitute for your attentiveness.

- ▶ When closing the roller sunblind, make sure that no body parts are in the range of movement.

**⚠ WARNING** Risk of becoming trapped despite reversing function

In particular, the reversing function does not react to soft, light and thin objects, e.g. fingers.

- ▶ When closing the roller sunblind, make sure that no body parts are in the range of movement.

- ▶ Release the button immediately if somebody becomes trapped.

or

- ▶ Briefly press the button in any direction during the automatic closing process. The closing process will be stopped.

#### Automatic functions of the sliding sunroof

- ① The term "sliding sunroof" also refers to the panorama roof with power tilt/sliding panel.

By pushing or pulling the  button, you can interrupt the automatic functions: "Rain closing function when driving" and "Automatic lowering".

#### Rain closing function when driving

**Vehicles with a panorama roof with power tilt/sliding panel:** If it starts to rain, the raised sliding sunroof will automatically be lowered while the vehicle is in motion.

#### Automatic lowering function

**Vehicles with a panorama roof with power tilt/sliding panel:** If the sliding sunroof is raised at the rear, it will automatically be lowered slightly at higher speeds. At low speeds, it will be raised again automatically.

**⚠ WARNING** Risk of becoming trapped by automatic lowering of the sliding sunroof

At higher speeds, the raised sliding sunroof will automatically be lowered slightly at the rear.

- ▶ Make sure that nobody reaches into the sliding sunroof's range of movement while the vehicle is in motion.
- ▶ If somebody becomes trapped, briefly push the sliding sunroof button forwards or backwards.

### Problems with the sliding sunroof

**⚠ WARNING** Risk of becoming trapped or fatal injuries when the sliding sunroof is closed again

If the sliding sunroof is closed again immediately after it has been blocked or reset, it will close with increased force.

- ▶ Make sure that no parts of the body are in the closing area.
- ▶ Release the button immediately if somebody becomes trapped.

or

- ▶ Briefly press the button in any direction during the automatic closing process. The closing process will be stopped.

**The sliding sunroof cannot be closed and you cannot see the cause.**

**i** The term "sliding sunroof" also refers to the panorama roof with power tilt/sliding panel.

If the sliding sunroof is obstructed during closing and reopens again slightly:

- ▶ Immediately after automatic reversing, pull and hold the  button down again to the point of resistance until the sliding sunroof is closed. The sliding sunroof will be closed with increased force.



If the sliding sunroof is obstructed again and reopens again slightly:

- ▶ Repeat the previous step. The sliding sunroof will be closed with even greater force.

**Vehicles with a panorama roof with power tilt/sliding panel: The sliding sunroof or the roller sunblind is not operating smoothly.**

- ▶ Reset the sliding sunroof and the roller sunblind.

**Resetting the sliding sunroof and the roller sunblind**

- ▶ Pull and hold the  button little by little until the sliding sunroof is fully closed.
- ▶ Pull and hold the  button little by little until the roller sunblind is fully closed.

- ▶ Use automatic operation to fully open and then close the sliding sunroof.

### Anti-theft protection

#### Function of the immobilizer

The immobilizer prevents your vehicle from being started without the correct SmartKey.

The immobilizer is automatically activated when the ignition is switched off and deactivated when the ignition is switched on.

When leaving the vehicle, always take the SmartKey with you and lock the vehicle. Anyone can start the engine if a valid SmartKey has been left inside the vehicle.

- i** In the event the engine cannot be started (yet the vehicle's battery is charged), the system is not operational. Contact an authorized Mercedes-Benz Center or call 1-800-FOR-MERCEdes (in the USA) or 1-800-387-0100 (in Canada).



## ATA (anti-theft alarm system)

### Function of the ATA system

If the ATA system is armed, a visual and audible alarm is triggered in the following situations:

- when a door is opened
- when the tailgate is opened
- when the hood is opened
- when interior protection is triggered (→ page 86)
- when the tow-away alarm is triggered (→ page 86)

The ATA system is armed automatically after approximately ten seconds in the following situations:

- after locking the vehicle with the SmartKey
- after locking the vehicle using KEYLESS-GO

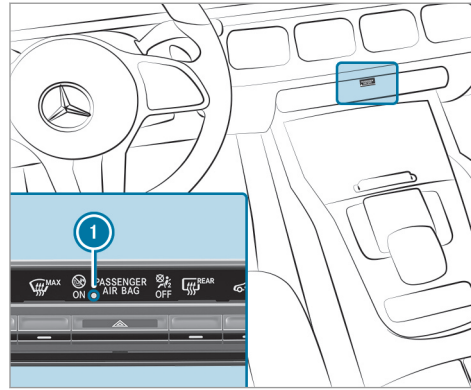

Indicator lamp ① flashes when the ATA system is armed.



The ATA system is deactivated automatically in the following situations:

- after unlocking the vehicle with the SmartKey
- after unlocking the vehicle using KEYLESS-GO

- after pressing the start/stop button with the SmartKey in the stowage compartment (→ page 144)

- ① When the Mercedes-Benz emergency call system is active and the alarm stays on for more than 30 seconds, a message is automatically sent to the Customer Assistance Center (→ page 277).
- ① In the case of severe battery discharging, the anti-theft alarm system is automatically deactivated to facilitate the next engine start.

### Deactivating the ATA

- ▶ Press the ,  or  button on the SmartKey.

or

- ▶ Press the start/stop button with the SmartKey in the marked space (→ page 144)

### Deactivating the alarm using KEYLESS-GO

- ▶ Grasp the outside door handle with the SmartKey outside the vehicle.

### Function of the tow-away alarm

-  This function may not be available in all countries.

An audible and visual alarm is triggered if an alteration to your vehicle's angle of inclination is detected while the tow-away alarm is armed.



The tow-away alarm is automatically armed after approximately 60 seconds:

- after locking the vehicle with the SmartKey
- after locking the vehicle using KEYLESS-GO

The tow-away alarm is only armed when the following components are closed:

- the doors
- the tailgate

The tow-away alarm is automatically deactivated:

- after pressing the  or  button on the SmartKey
- after pressing the start/stop button with the SmartKey in the stowage compartment (→ page 144)

- after unlocking the vehicle using KEYLESS-GO
- when using HANDS-FREE ACCESS

Information on collision detection on a parked vehicle (→ page 172).

### Arming/disarming the tow-away alarm

Multimedia system:

   Settings  Quick Access

 Arm or disarm [Tow-away Protection](#).

The tow-away alarm is armed again in the following cases:

- The vehicle is unlocked again.
- A door is opened.
- The vehicle is locked again.

-  If quick access is unavailable, select the [Vehicle](#) submenu in the [Settings](#) main menu to arm or disarm the tow-away alarm.

### Function of the interior motion sensor

-  This function may not be available in all countries.

When the interior motion sensor is activated, a visual and audible alarm is triggered if movement is detected in the vehicle interior.



The interior motion sensor is activated automatically after approximately ten seconds:

- after locking the vehicle with the SmartKey
- after locking the vehicle using KEYLESS-GO

The interior motion sensor is only activated when the following components are closed:

- the doors
- the tailgate

The interior motion sensor is automatically deactivated:

- after pressing the  or  button on the SmartKey
- after pressing the start/stop button with the SmartKey in the storage compartment (→ page 144)

- after unlocking the vehicle using KEYLESS-GO
- when using HANDS-FREE ACCESS

The following situations can lead to a false alarm:

- moving objects such as mascots in the vehicle interior
- when the side window is open
- when the panoramic sliding sunroof is open

### Arming/deactivating the interior motion sensor

---

Multimedia system:

  **Settings** **Quick Access**

- ▶ Activate or deactivate **Interior Motion Sensor**.

The interior motion sensor is activated again in the following cases:

- The vehicle is unlocked again.
- A door is opened.
- The vehicle is locked again.

- ① If quick access is unavailable, select the **Vehicle** menu under **Settings** to activate or deactivate the interior motion sensor.

### Notes on the correct driver's seat position

**⚠ WARNING** Risk of accident due to adjusting vehicle settings while the vehicle is in motion

You could lose control of the vehicle in the following situations in particular:

- If you adjust the driver's seat, the head restraints, the steering wheel or the mirror while the vehicle is in motion.
  - If you fasten your seat belt while the vehicle is in motion.
- Before starting the engine: adjust the driver's seat, the head restraints, the steering wheel and the mirror and fasten your seat belt.

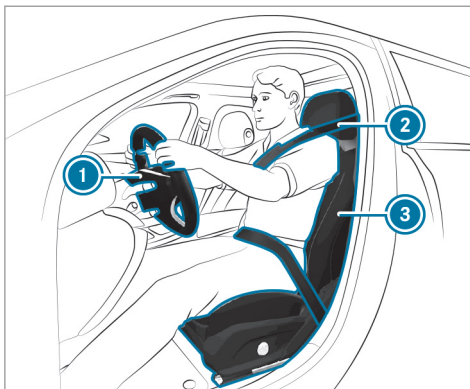

Ensure the following when adjusting steering wheel ①, seat belt ② and driver's seat ③:

- You are sitting as far away from the driver's airbag as possible, taking the following points into consideration.
- You are sitting in an upright position
- Your thighs are slightly supported by the seat cushion

- Your legs are not fully extended and you can depress the pedals properly
- The back of your head is supported at eye level by the center of the head restraint
- You can hold the steering wheel with your arms slightly bent
- You can move your legs freely
- You can see all the displays on the instrument cluster clearly
- You have a good overview of the traffic conditions
- Your seat belt sits snugly against your body and passes across the center of your shoulder and across your hips in the pelvic area

### Seats

#### Adjusting the front seat

**⚠ WARNING** Risk of becoming trapped if the seats are adjusted by children

Children could become trapped if they adjust the seats, particularly when unattended.

- ▶ When leaving the vehicle, always take the SmartKey with you and lock the vehicle.
- ▶ Never leave children unattended in the vehicle.

You can adjust the seats when the ignition is switched off.

**⚠ WARNING** Risk of becoming trapped when adjusting the seat

When you adjust a seat, you or other vehicle occupants could become trapped, e.g. on the seat guide rail.

- ▶ When adjusting a seat, make sure that no one has any part of their body within the sweep of the seat.

Observe the safety notes on "Airbags" and "Children in the vehicle".

**⚠ WARNING** Risk of accident due to adjusting vehicle settings while the vehicle is in motion

You could lose control of the vehicle in the following situations in particular:

- If you adjust the driver's seat, the head restraints, the steering wheel or the mirror while the vehicle is in motion.
  - If you fasten your seat belt while the vehicle is in motion.
- ▶ Before starting the engine: adjust the driver's seat, the head restraints, the steering wheel and the mirror and fasten your seat belt.

**⚠ WARNING** Risk of becoming trapped if the seat height is adjusted carelessly

If you adjust the seat height carelessly, you or other vehicle occupants could be trapped and thereby injured.

Children in particular could accidentally press the electrical seat adjustment buttons and become trapped.

- ▶ While moving the seats, make sure that hands or other body parts do not get under the lever assembly of the seat adjustment system.

**⚠ WARNING** Risk of injury due to head restraints not being installed or being adjusted incorrectly

If head restraints have not been installed or have not been adjusted correctly, there is an increased risk of injury in the head and neck area, e.g. in the event of an accident or when braking.

- ▶ Always drive with the head restraints installed.
- ▶ Before driving off, make sure for every vehicle occupant that the center of the head restraint supports the back of the head at about eye level.

Do not interchange the head restraints of the front and rear seats. Otherwise, you will not be able to adjust the height and angle of the head restraints correctly.

Adjust the head restraint fore-and-aft position so that it is as close as possible to the back of your head.

**⚠ WARNING** Risk of injury or death due to an incorrect seat position

The seat belt does not offer the intended level of protection if you have not moved the seat backrest to an almost vertical position.

You could slip beneath the seat belt and injure yourself.

- ▶ Adjust the seat properly before commencing your journey.
- ▶ Always ensure that the seat backrest is in an almost vertical position and that the shoulder belt is routed across the center of your shoulder.

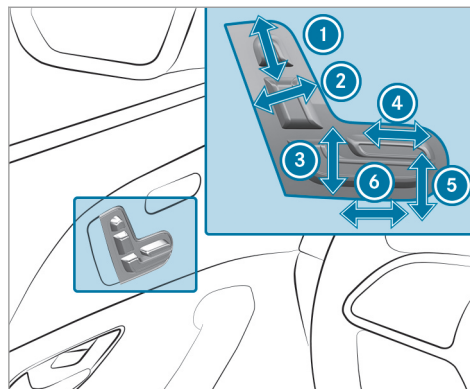

- ① Head restraint height
- ② Seat backrest inclination
- ③ Seat height
- ④ Seat cushion length
- ⑤ Seat cushion inclination
- ⑥ Seat fore-and-aft position

- ▶ Save the settings with the memory function (→ page 101).

### Adjusting the front passenger seat electrically from the driver's seat

#### Requirements:

- The power supply is switched on.

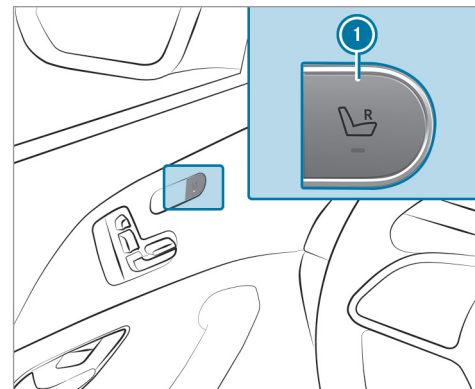

You can call up the following functions for the front passenger seat:

- Seat adjustment

- Seat heating
- Seat ventilation
- Memory function

- ▶ **To select the front passenger seat:** press button ❶. When the indicator lamp lights up, the front passenger seat is selected.
- ▶ Adjust the front passenger seat using the buttons on the driver's side door control panel.
- ▶ **Select the driver's seat:** press button ❶ again. When the indicator lamp goes out, the driver's seat has been selected.

### Adjusting the 4-way lumbar support

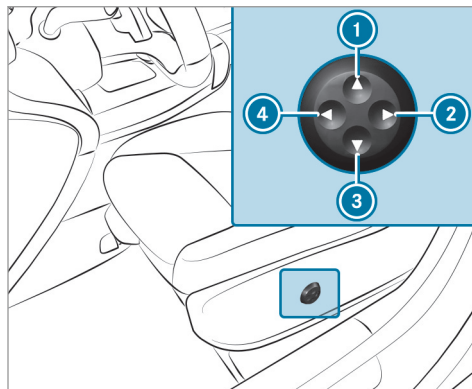

- ❶ Higher
- ❷ Softer
- ❸ Lower
- ❹ Firmer

- ▶ Using buttons ❶ to ❹, adjust the contour of the backrest individually to suit your back.

### Head restraints

#### Adjusting the front seat head restraints manually

**⚠ WARNING** Risk of accident due to adjusting vehicle settings while the vehicle is in motion

You could lose control of the vehicle in the following situations in particular:

- If you adjust the driver's seat, the head restraints, the steering wheel or the mirror while the vehicle is in motion.
  - If you fasten your seat belt while the vehicle is in motion.
- ▶ Before starting the engine: adjust the driver's seat, the head restraints, the steering wheel and the mirror and fasten your seat belt.

**⚠ WARNING** Risk of injury due to head restraints not being installed or being adjusted incorrectly

If head restraints have not been installed or have not been adjusted correctly, there is an increased risk of injury in the head and neck area, e.g. in the event of an accident or when braking.

- ▶ Always drive with the head restraints installed.
- ▶ Before driving off, make sure for every vehicle occupant that the center of the head restraint supports the back of the head at about eye level.

Do not interchange the head restraints of the front and rear seats. Otherwise, you will not be able to adjust the height and angle of the head restraints correctly.

Adjust the head restraint fore-and-aft position so that it is as close as possible to the back of your head.

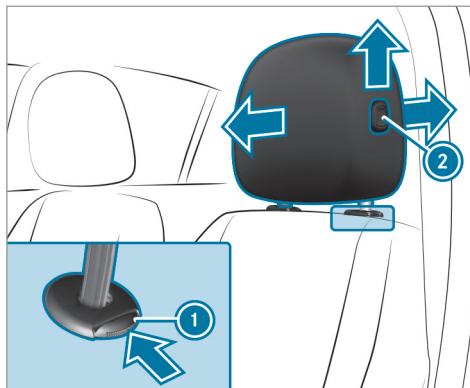

- ▶ **To raise:** pull the head restraint up.
- ▶ **To lower:** press release knob ① in the direction of the arrow and push the head restraint down.
- ▶ **To move forward:** press release knob ② and pull the head restraint forward.
- ▶ **To move backwards:** press release knob ② and push the head restraint backwards.

### Adjusting the front seat luxury head restraints mechanically

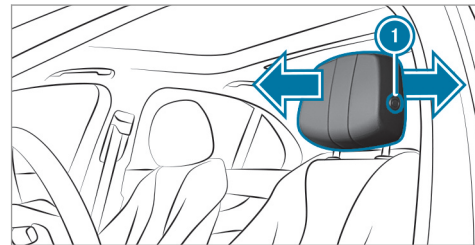

- ▶ **To move forward:** press release knob ① and pull the head restraint forward.
- ▶ **To move backwards:** press release knob ① and push the head restraint backwards.



### Adjusting the head restraints of the rear seats mechanically

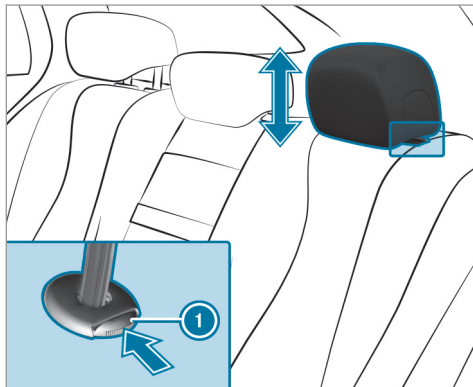

- ▶ **To raise:** pull the head restraint up.
- ▶ **To lower:** press release knob ① in the direction of the arrow and push the head restraint down.

### Installing/removing the rear seat head restraints

#### Removing

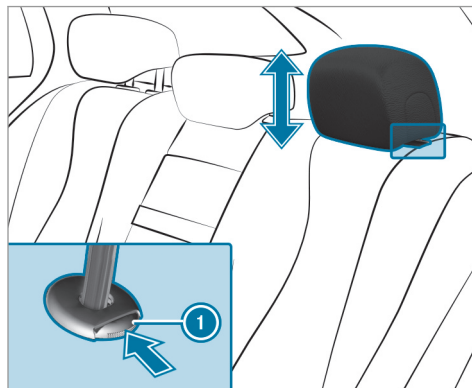

- ▶ Release the rear seat backrest and fold it forwards slightly (→ page 104).
- ▶ Pull the head restraint upwards as far as it will go.

- ▶ Push release knob ① in the direction of the arrow and pull out the head restraint.

#### Installing

- ▶ Insert the head restraint such that the notches on the bar are on the left when viewed in the direction of travel.
- ▶ Push the head restraint down until it engages.
- ▶ Fold the rear seat backrest back until it engages.

### Configuring the seat settings

Multimedia system:

→ ▶ **Comfort** ▶ **Seat Comfort**

### Adjusting the backrest contour in the lumbar region of the seat backrest (lumbar)

- ▶ Select **Lumbar**.
- ▶ Select the settings for the desired seat.
- ▶ Adjust the air cushions.

### Adjusting the backrest side bolsters

- ▶ Select [Side Bolsters](#).
- ▶ Adjust the air cushion for the desired seat.

### Setting the seat heating balance

- ▶ Select [Seat Heating Balance](#).
- ▶ Adjust the heat distribution for the desired seat.

### Setting automatic seat adjustment

**⚠ WARNING** Risk of becoming trapped during adjustment of the driver's seat after calling up a driver profile

Selecting a profile may trigger an adjustment of the driver's seat to the position saved under the profile. You or other vehicle occupants could be injured in the process.

- ▶ Make sure that when the position of driver's seat is being adjusted using the multimedia system, no people or body parts are in the seat's range of movement.

If there is a risk of someone becoming trapped, stop the adjustment process immediately:

- ▶ a) Tap the warning message on the media display.
  - or
  - ▶ b) Press a memory position button or a seat adjustment switch on the driver's door.
- The adjustment process is stopped.

#### Requirements:

- Adapting the driver's seat and steering wheel position to the body size: automatic seat adjustment has been switched on.

Multimedia system:

- ▶  ▶ [Settings](#) ▶ [Vehicle](#)
- ▶ [Automatic Seat Adjustment](#)

#### Switching automatic seat adjustment on/off

When the active user profile is changed while the vehicle is stationary, the driver's seat, steering

wheel, outside mirrors and seat contour will automatically be adapted to the driver.

- ▶ Select [On](#) or [Off](#).
- ⓘ This setting is available only for individual user profiles. For the guest profile, automatic seat adjustment cannot be switched on or off. Further information about user profiles .

#### Adjusting driver's seat and steering wheel position to body size

The vehicle calculates a suitable driver's seat and steering wheel position on the basis of the driver's body size and sets this directly.

- ▶ **To set the unit of measurement:** select [cm](#) or [ft/in](#).
- ▶ Set the size using the scale.
- ▶ Select [Start Positioning](#).  
The driver's seat and steering wheel position is adjusted to the body size that has been set.

- ❶ If the driver's seat and steering wheel position calculated by the vehicle is not practical or comfortable, it can be manually changed at any time via the buttons. The exterior mirrors are not set via this function. Instead, they have to be set manually via the switches.
- ❷ You can also make these settings via the Mercedes me portal for your user profile. By synchronising the profiles in the vehicle and the Mercedes me connect profiles, you can carry over these settings for your vehicle. Further information about synchronising user profiles .

### Setting the easy entry and exit feature

- ▶ Select **Steering Wheel & Seat, Steering Wheel Only** or **Off**.
- ❶ If you use an individual user profile and have set your body size, this information is carried over for the easy entry and exit feature. This causes the driver's seat and steering wheel to automatically move into the correct position .

### Overview of massage programs

- **Hot Relaxing Back** Combination of heat and massage. It starts by massaging the back. In addition, warm pressure points become noticeable, starting in the pelvic area.
- **Hot Relaxing Shoulder** Combination of heat and massage. It starts by massaging the shoulders. In addition, warm pressure points become noticeable, starting in the pelvic area.
- **Activating Massage** Activating massage with upward-moving massage waves.
- **Classic Massage** Relaxing back massage.
- **Wave Massage** Regenerating massage via massage waves across the back and in the seat cushion.
- **Mobilizing Massage** Mobilizing Massage with upward-moving massage waves. Can promote deeper respiration and hence improve circulation and blood pressure.
- **Active Workout, Backrest** and **Active Workout, Cushion** These programs require your cooperation. Alternating between tensing

and releasing helps to improve blood flow to your muscles. Press against a pressure point as soon as you feel it.

### Selecting the massage program for the front seats

Multimedia system:

→  ▶▶ **Comfort** ▶▶ **Massage**

- ▶ Select a massage program (→ page 95).
- ▶ Start the program for the desired seat .
- ▶ **To set the massage intensity:** switch **High Intensity** on or off.

❶ For the rear seats, the massage program can be selected on the following devices (if available):

- On the rear displays  
The selection can be made for the rear seats on the second and third rows of seats.
- On the MBUX rear tablet

The selection is made in the same way as on the rear displays for the rear seats on the second row of seats.

### Resetting seat settings

Multimedia system:

→  → **Comfort** → **Seat Comfort**

▶ Select  for the desired seat.

▶ Confirm the prompt.

### Switching the seat heating on/off

**⚠ WARNING** Risk of burns due to repeatedly switching on the seat heating

Repeatedly switching on the seat heating can cause the seat cushion and seat backrest padding to become very hot.

The health of persons with limited temperature sensitivity or a limited ability to react to high temperatures may be affected or they may even suffer burn-like injuries.

▶ Do not repeatedly switch on the seat heating.

To protect against overheating, the seat heating may be temporarily deactivated after it is switched on repeatedly.

**!** **NOTE** Damage to the seats caused by objects or documents when the seat heating is switched on

When the seat heating is switched on, overheating may occur due to objects or documents placed on the seats, e.g. seat cushions or child seats. This could cause damage to the seat surface.

▶ Make sure that no objects or documents are on the seats when the seat heating is switched on.

#### Requirements:

- The power supply is switched on.

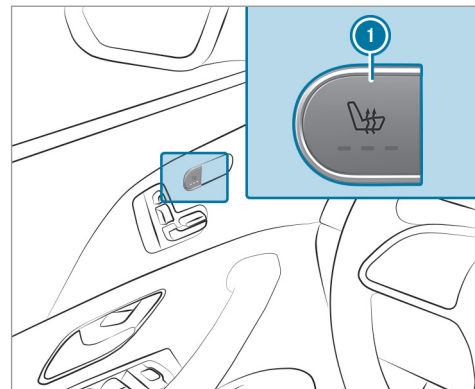

Seat heating in the cockpit

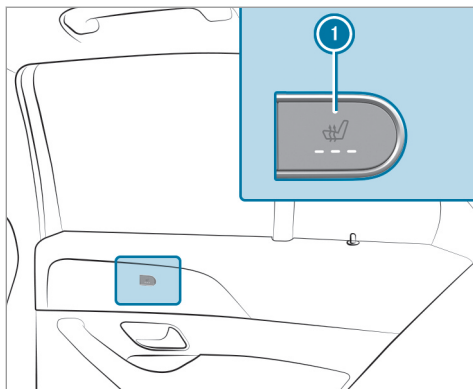

Seat heating in the rear passenger compartment

- ▶ Press button ❶ repeatedly until the desired heating level is set. Depending on the heating level, up to three indicator lamps will light up. If all indicator lamps are off, the seat heating is switched off.

❶ The seat heating will automatically switch down from the three heating levels after 8,

10 and 20 minutes until the seat heating is switched off.

### Setting the panel heating

Multimedia system:

- ▶ Home ▶ Settings ▶ Vehicle
- ▶▶ Panel Heating

When the seat heating is switched on, the armrests, the door center panel and the center console can be heated.

- ▶ Switch the function for the desired seats on or off.

### Switching the seat ventilation on/off

**Requirements:**

- The power supply is switched on.

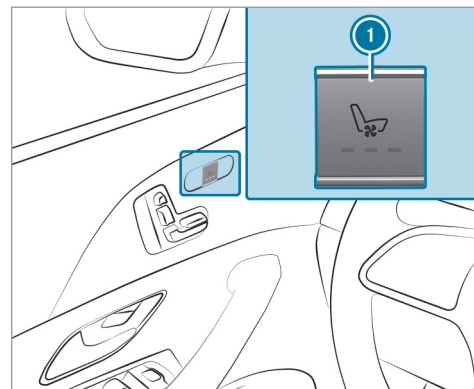

Seat ventilation in the cockpit

- ▶ Press button ❶ repeatedly until the desired ventilation level is set. Depending on the ventilation level, up to three indicator lamps will light up. If all indicator lamps are off, the seat ventilation is switched off.

## Steering wheel

### Adjusting the steering wheel mechanically

**⚠ WARNING** Risk of accident due to adjusting vehicle settings while the vehicle is in motion

You could lose control of the vehicle in the following situations in particular:

- If you adjust the driver's seat, the head restraints, the steering wheel or the mirror while the vehicle is in motion.
  - If you fasten your seat belt while the vehicle is in motion.
- ▶ Before starting the engine: adjust the driver's seat, the head restraints, the steering wheel and the mirror and fasten your seat belt.

**⚠ WARNING** Risk of entrapment for children when adjusting the steering wheel

Children could injure themselves if they adjust the steering wheel.

- ▶ Never leave children unattended in the vehicle.
- ▶ When leaving the vehicle, always take the SmartKey with you and lock the vehicle.

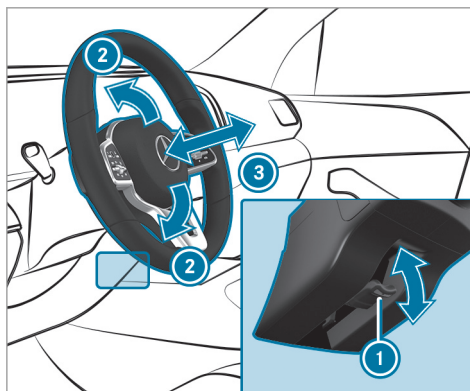

- ▶ **To unlock:** push release lever ① down as far as it will go.

- ▶ Adjust height ② and distance ③ to the steering wheel.
- ▶ **To lock:** push release lever ① up as far as it will go.
- ▶ Check and make sure that the steering column is locked by moving the steering wheel.

### Adjusting the steering wheel electrically

The steering wheel can be adjusted when the ignition is switched off.

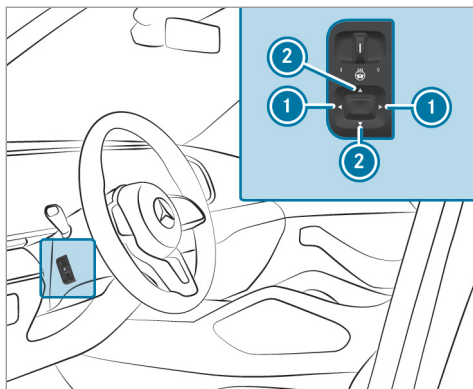

- ① To adjust the distance to the steering wheel
- ② To adjust the height
- ▶ Save the settings with the memory function (→ page 101).

### Switching the steering wheel heater on or off

#### Requirements:

- The ignition is switched on.

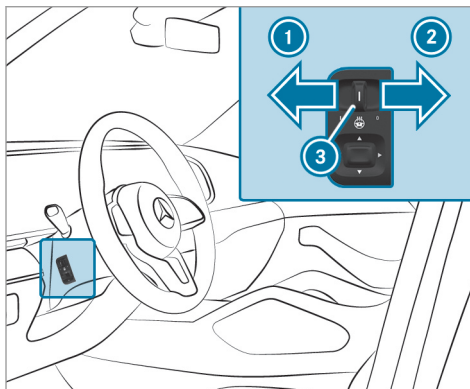

- ▶ **To switch on:** push the switch to position ①. Indicator lamp ③ lights up.
- ▶ **To switch off:** push the switch to position ②. Indicator lamp ③ goes out.

When you switch the ignition off, the steering wheel heater switches off.

### Easy entry and exit feature

#### Using the easy entry and exit feature

- ⚠ **WARNING** Risk of accident when pulling away during the adjustment process for the easy exit feature

You could lose control of the vehicle.

- ▶ Always wait until the adjustment process is complete before pulling away.

- ⚠ **WARNING** Risk of becoming trapped while adjusting the easy entry and exit feature

You and other vehicle occupants could become trapped.

- ▶ Ensure that no-one has a body part in the range of movement of the seat or steering wheel.

- ▶ If someone becomes trapped, move the steering wheel adjustment lever. The adjustment process will be stopped.

If there is a risk of becoming trapped by the driver's seat:

- ▶ Press the seat adjustment switch. The adjustment process will be stopped.

**Vehicles with memory function:** You can stop the adjustment process by pressing one of the memory function position switches.

**⚠ WARNING** Risk of becoming trapped during activation of the easy entry and exit feature by children

If children activate the easy entry and exit feature, they can become trapped, particularly when unattended.

- ▶ Never leave children unattended in the vehicle.

- ▶ When leaving the vehicle, always take the SmartKey with you and lock the vehicle.

If the easy entry and exit feature is active, the steering wheel will move upwards and the driver's seat will move back in the following situations:

- You switch the ignition off with the driver's door open.
- You open the driver's door with the ignition switched off.

- ① The steering wheel will then move upwards only if it is not already as high as it will go. The driver's seat will then move backwards only if it is not already in the rearmost position. The driver's seat backrest will then move forwards only if it is not already in the frontmost position.

The steering wheel and the driver's seat will move back to the last drive position in the following cases:

- You switch the power supply or the ignition on when the driver's door is closed.
- You close the driver's door with the ignition switched on.

The last drive position will be saved when:

- You switch the ignition off.
- **Vehicles with memory function:** You call up the seat settings via the memory function.
- **Vehicles with memory function:** You save the seat settings via the memory function.

**Vehicles with memory function:** Press one of the memory function position buttons to stop the adjustment process.



### Operating the memory function

**⚠ WARNING** Risk of an accident if the memory function is used while driving

If you use the memory function on the driver's side while driving, you could lose control of the vehicle as a result of the adjustments being made.

- ▶ Only use the memory function on the driver's side when the vehicle is stationary.

**⚠ WARNING** Risk of entrapment when setting the seat with the memory function

When the memory function adjusts the seat, you and other vehicle occupants – particularly children – could become trapped.

- ▶ During the adjustment process of the memory function, make sure that no one has any body parts in the sweep of the seat.

- ▶ If someone becomes trapped, press a preset position button or seat adjustment switch immediately.

**⚠ WARNING** Risk of entrapment if the memory function is activated by children

Children could become trapped if they activate the memory function, particularly when unattended.

- ▶ Never leave children unattended in the vehicle.
- ▶ When leaving the vehicle, always take the SmartKey with you and lock the vehicle.

You can use the memory function when the ignition is switched off.

#### Storing

Seat adjustments for up to three people can be stored and called up using the memory function. You can save settings for the following systems:

- Front seat

- Outside mirrors
- Head-up Display
- Steering column
- Seat contour

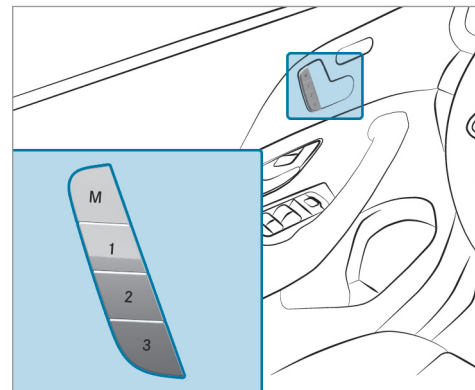

- ▶ Set all systems to the desired position.

- ▶ Briefly press the **M** memory button and then press preset position **1**, **2** or **3** within three seconds.  
An acoustic signal sounds. The settings are stored.
- ▶ **To call up:** press and briefly hold preset position button **1**, **2** or **3**.  
After releasing the button, all systems are moved into the stored position.

### Stowage areas

#### Notes on loading the vehicle

#### **⚠ DANGER** Risk of exhaust gas poisoning

Combustion engines emit poisonous exhaust gases such as carbon monoxide. Exhaust gases can enter the vehicle interior if the tailgate is open when the engine is running, especially if the vehicle is in motion.

- ▶ Always switch off the engine before opening the tailgate.
- ▶ Never drive with the tailgate open.

#### **⚠ WARNING** Risk of injury from unsecured items in the vehicle

If objects, luggage or loads are not secured or not secured sufficiently, they could slip, tip over or be thrown around and thereby hit vehicle occupants.

There is a risk of injury, particularly in the event of sudden braking or a sudden change in direction.

- ▶ Always stow objects in such a way that they cannot be thrown around.
- ▶ Before the journey, secure objects, luggage or loads against slipping or tipping over.

#### **⚠ WARNING** Risk of injury due to objects being stowed incorrectly

If you do not adequately stow objects in the vehicle interior, they could slip or be tossed around and thereby strike vehicle occupants. In addition, cup holders, open stowage spaces and mobile phone brackets cannot

always restrain the objects they contain in the event of an accident.

There is a risk of injury, particularly in the event of sudden braking or a sudden change in direction.

- ▶ Always stow objects in such a way that they cannot be tossed about in these or similar situations.
- ▶ Always make sure that objects do not project from stowage spaces, parcel nets or stowage nets.
- ▶ Close the lockable stowage spaces before starting a journey.
- ▶ Stow and secure objects that are heavy, hard, pointed, sharp-edged, fragile or too large in the cargo compartment.

#### **⚠ WARNING** - Risk of accident or injury when using the cup holder while the vehicle is moving

The cup holder cannot secure containers while the vehicle is moving.

If you use a cup holder while the vehicle is moving, the container may be flung around and liquids may be spilled. The vehicle occupants may come into contact with the liquid and if it is hot, they could be scalded. You could be distracted from traffic conditions and you may lose control of the vehicle.

- ▶ Only use the cup holder when the vehicle is stationary.
- ▶ Only use the cup holder for containers of the right size.
- ▶ Close the container, particularly if the liquid is hot.

**!** **NOTE** Damage to the cup holder

When the rear armrest is folded back the cup holder could become damaged.

- ▶ Only fold the rear armrest back when the cup holder is closed.

**!** **NOTE** Damage to the rear armrest due to body weight

When folded out, the rear armrest can be damaged by body weight.

- ▶ Do not sit or support yourself on the rear seat armrest.

**!** **WARNING** Risk of injury due to an open cargo compartment floor

If you drive with the cargo compartment floor open, objects could be flung around and hit vehicle occupants as a result. There is a risk of injury, particularly in the event of sudden braking or a sudden change in direction.

- ▶ Always close the cargo compartment floor before a journey.

**!** **WARNING** - Risk of fire and injury from hot cigarette lighter

You can burn yourself if you touch the hot heating element or the socket of the cigarette lighter.

In addition, flammable materials may ignite if:

- you drop the hot cigarette lighter
  - a child holds the hot cigarette lighter to objects, for example
- ▶ Always hold the cigarette lighter by the knob.
  - ▶ Always make sure that the cigarette lighter is out of reach of children.
  - ▶ Never leave children unattended in the vehicle.

**!** **WARNING** Risk of burns from the tailpipe and tailpipe trims

The exhaust tailpipe and tailpipe trims can become very hot. If you come into contact with these parts of the vehicle, you could burn yourself.

- ▶ Always be particularly careful around the tailpipe and the tailpipe trims and supervise children especially closely in this area.

- ▶ Allow vehicle parts to cool down before touching them.

The driving characteristics of your vehicle are dependent on the distribution of the load within the vehicle. You should bear the following in mind when loading the vehicle:

- Never exceed the permissible gross mass or the gross axle weight rating for the vehicle (including occupants). The values are specified on the vehicle identification plate on the vehicle's B-pillar.
- The load must not protrude above the upper edge of the seat backrests.
- Always use the partition net when transporting objects in the cargo compartment.
- Always place the load behind unoccupied seats if possible.
- Secure the load using the tie-down eyes and distribute the load evenly.

### Stowage spaces in the vehicle interior

#### Overview of the front storage compartments

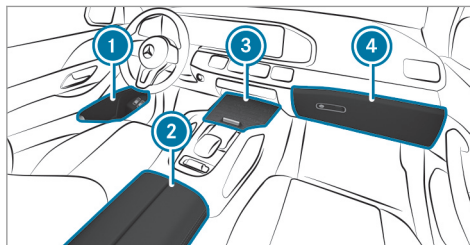

- ① Storage space in the doors
- ② Storage compartment in the armrest with USB ports (depending on vehicle equipment)
- ③ Storage/telephone compartment with cup holder in the center console at front
- ④ Glove box

### Through-loading feature in the rear bench seat (EASY-PACK Quickfold)

#### Folding the rear seat backrest forwards

**⚠ WARNING** Risk of becoming trapped when adjusting the seats

When you adjust a seat, you may trap yourself or a vehicle occupant.

- ▶ When adjusting a seat, make sure that no one has any body parts in the sweep of the seat.

**⚠ WARNING** Risk of accident if the seat and seat backrest are not engaged

The seat and seat backrest can fold forwards.

There is a risk of the following, in particular:

- The vehicle occupant may be pressed against the seat belt. The seat belt will not be able to protect as intended and could cause additional injury.

- A child restraint system will no longer be properly supported or positioned and will no longer fulfill its function as intended.
- The seat backrest will not be able restrain objects or goods in the cargo compartment.

Always ensure that the seat and seat backrest are engaged, in particular:

- Before persons travel in the vehicle while sitting on a seat with the easy entry and exit feature
- After you have adjusted the seat
- After the easy entry and exit feature has been used
- After the cargo compartment enlargement has been folded forwards

Always ensure that all vehicle occupants have their seat belts fastened correctly and are sitting properly. Particular attention must be paid to children.

If you no longer require the folded-down rear seat backrest as a load area, fold the backrest back into place.

Make sure that the red marking of the lock verification indicator is no longer visible. Otherwise, the seat backrest will not be locked.

#### Folding the rear seats forwards mechanically

**NOTE** Damage to the headliner when the rear seat backrests are folded forwards and backwards

The headliner could be damaged when the seat backrests are folded forwards and backwards.

- ▶ Before you fold the seat backrests forwards and backwards, insert the head restraints.

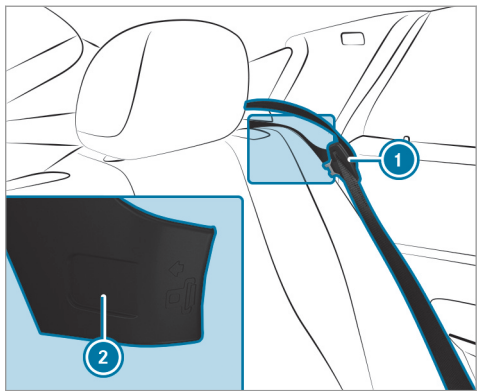

- ▶ Press the seat belt tongue of seat belt ① into marked position ②.

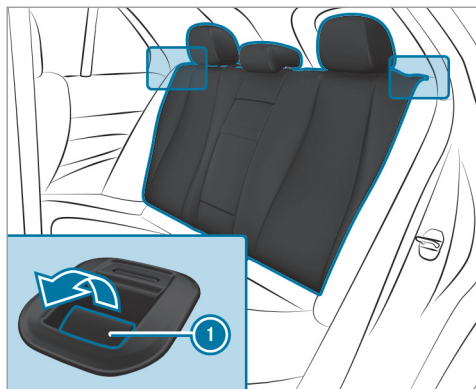

- ▶ Move the driver's or front passenger seat forwards, if necessary.
- ▶ **To fold the left and right seat backrests forwards:** insert the head restraints for the seat backrests (→ page 93).
- ▶ Pull release lever ①.
- ▶ Fold the corresponding seat backrest forwards.

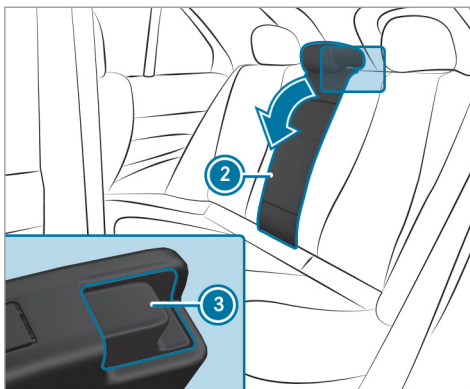

- ▶ **To fold the center seat backrest forwards:** press release catch ③.
- ▶ Fold seat backrest ② forwards.
- ① Observe the following recommendations:
  - If you wish to fold only one of the outer seat backrests forwards, it is recommended that you fold the right seat backrest forwards.

- If you wish to fold one of the outer seat backrests forwards together with the center seat backrest, it is recommended that you fold the left and center seat backrests forwards.

#### Folding back the rear seat backrest

**!** **NOTE** Damage caused by trapping the seat belt when the seat backrest is folded back

The seat belt could become trapped and thus damaged when the seat backrest is folded back.

- ▶ Ensure that the seat belt tongue has been inserted at the side in the marked position.

**!** **NOTE** Damage to the headliner when the rear seat backrests are folded forwards and backwards

The headliner could be damaged when the seat backrests are folded forwards and backwards.

- ▶ Before you fold the seat backrests forwards and backwards, insert the head restraints.

### Folding back the rear seat mechanically

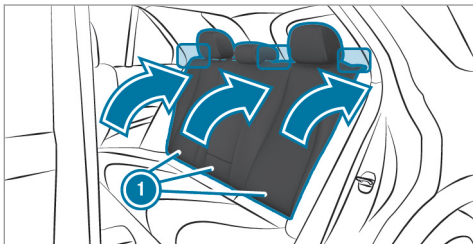

- ▶ Move the driver's or front passenger seat forwards, if necessary.
- ▶ Swing seat backrest ① back until it engages.
- ▶ Make sure that the red marking of the lock verification indicator is no longer visible. Otherwise, the seat backrest will not be locked.

### Collapsible cargo compartment cover

#### Notes on the collapsible cargo compartment cover

**⚠ WARNING** Risk of injury or death due to poorly secured objects

The cargo compartment cover alone cannot secure or restrain heavy objects, items of luggage or heavy loads.

You could be hit by an unsecured load, particularly in the event of abrupt changes in direction, sudden braking or an accident.

- ▶ Always stow objects in such a way that they cannot be thrown around.
- ▶ Secure objects, luggage or loads against slipping or tipping over, e.g. by using tie downs, even if you are using the cargo compartment cover.

**!** **NOTE** Damage to the collapsible cargo compartment cover when the vehicle is being loaded

When the vehicle is being loaded, the collapsible cargo compartment cover may be damaged.

- ▶ Do not place any objects above the lower edge of the side windows or on the collapsible cargo compartment cover.

### Unfolding the collapsible cargo compartment cover

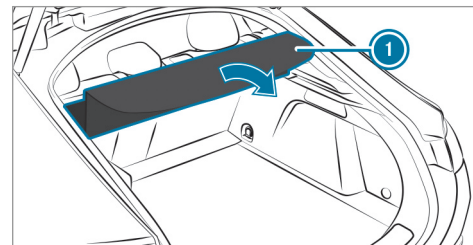

- ▶ Lift collapsible cargo compartment cover ① by the handle, unfold it in the direction of the arrow and place it on the edge.

### Folding up the collapsible cargo compartment cover

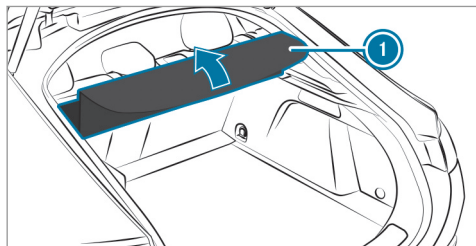

- ▶ Lift collapsible cargo compartment cover ① by the handle, guide it forwards in the direction of the arrow until it has completely folded up and stow it away in the folded state.

### Installing and removing the collapsible cargo compartment cover

#### Requirements:

- The collapsible cargo compartment cover is folded up.

### Removing the collapsible cargo compartment cover

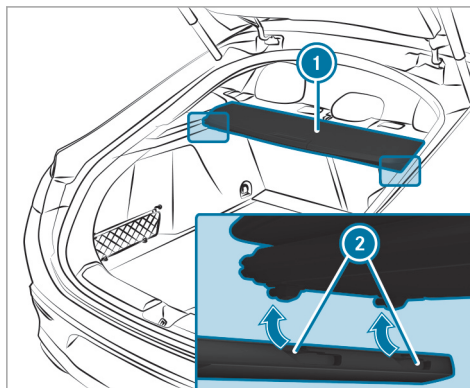

- ▶ Pull collapsible cargo compartment cover ① towards the rear by the bottom, folded-up section and remove it in the direction of the arrow from brackets ② on the left and right.

### Installing the collapsible cargo compartment cover

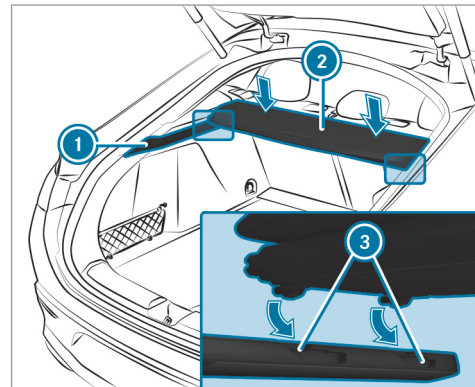

- ▶ Place collapsible cargo compartment cover ② on edge ①.
- ▶ Place collapsible cargo compartment cover ② into the brackets on the left and right ③



and push it forwards in the direction of the arrow.  
The end caps of the collapsible cargo compartment cover will engage.

### Overview of the tie-down eyes in the cargo compartment

Observe the notes on loading the vehicle (→ page 102).

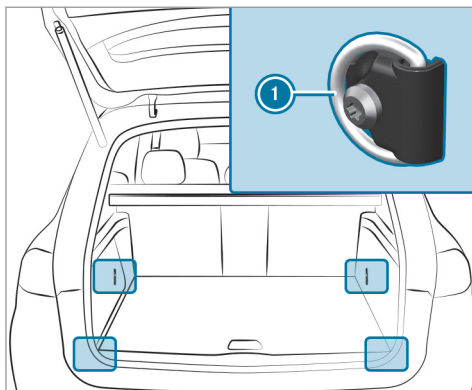

① Cargo tie-down rings

### Overview of bag hooks

**⚠ WARNING** Risk of injury when using bag hooks with heavy objects

The bag hooks cannot restrain heavy objects or items of luggage.

Objects or items of luggage may be flung around and hit vehicle occupants.

- ▶ Only hang light objects on the bag hooks.
- ▶ Never hang hard, sharp-edged or fragile objects on the bag hooks.

Observe the notes on loading the vehicle (→ page 102).

Subject the bag hooks to a maximum load of 6.6 lbs (3 kg) and do not attach any goods to them.

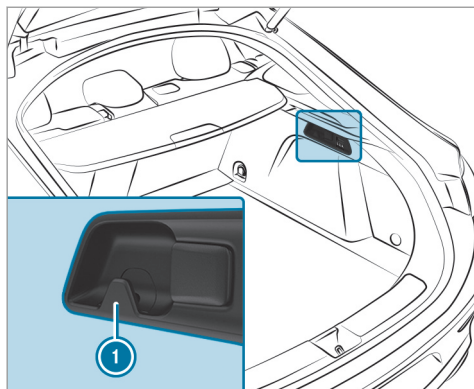

1 Bag hook

### Coat hook on the tailgate

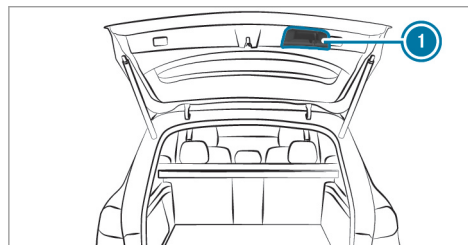

1 Coat hook on the tailgate

Coat hooks are not suitable for heavy objects. Use the coat hooks only for light objects such as jackets.

### Using the coat hooks in the rear passenger compartment

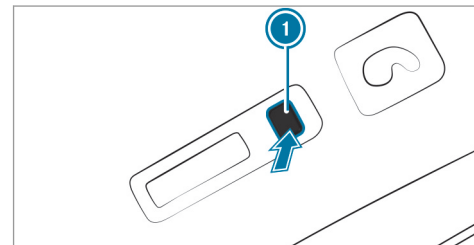

▶ Press coat hooks 1 at the bottom. Coat hook 1 extends.

i Observe the notes on loading the vehicle (→ page 102).

### EASY-PACK load-securing kit

#### Notes on the snap-in module for the cargo compartment (telescopic rods)

The EASY-PACK load-securing kit allows you to use your cargo compartment for a variety of pur-

poses. The components are located in the stowage space under the cargo compartment floor.

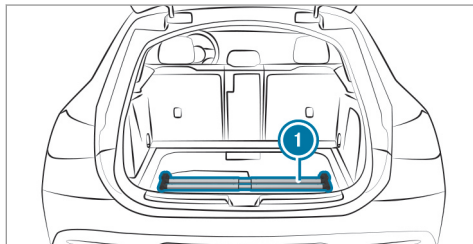

- ① Telescopic rod with mounting elements and holders

### Installing a telescopic rod

**⚠ WARNING** Risk of injury due to an open cargo compartment floor

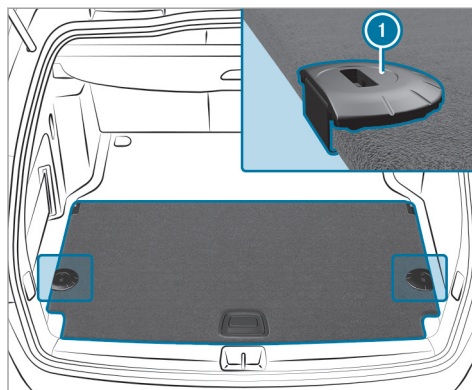

If you drive with the cargo compartment floor open, objects could be flung around and hit vehicle occupants as a result. There is a risk of injury, particularly in the event of sudden braking or a sudden change in direction.

- ▶ Always close the cargo compartment floor before a journey.

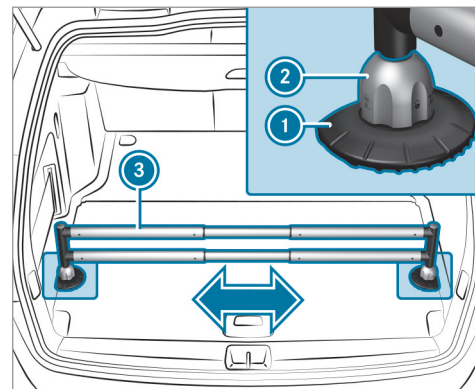

- ▶ Open the cargo compartment floor (→ page 112).
- ▶ Attach holders ① in the desired position at the side of the cargo compartment floor.
- ▶ Close the cargo compartment floor.



- ▶ Turn mounting elements ② to .
- ▶ Insert mounting elements ② into holders ①.
- ▶ Extend telescopic rod ③.
- ▶ Insert telescopic rod ③ into mounting elements ②.
- ▶ Turn both mounting elements ② to .

### Opening or closing the stowage space under the cargo compartment floor

**⚠ WARNING** Risk of injury due to an open cargo compartment floor

If you drive when the cargo compartment floor is open, objects could be thrown around and thereby strike vehicle occupants. There is a risk of injury, particularly in the event of sudden braking or a sudden change in direction.

▶ Always close the cargo compartment floor before a journey.

#### Opening

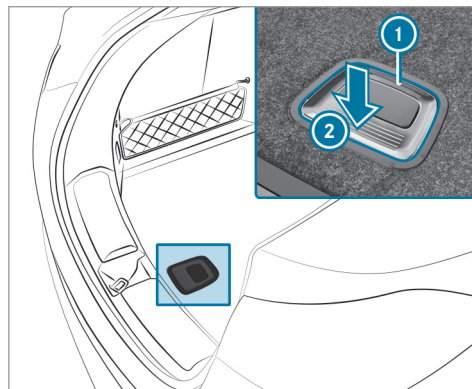

- ▶ Holding the ribbing, press handle ① downward ②. Handle ① will flip up.
- ▶ Swing the cargo compartment floor upward using handle ① and hold it in place.

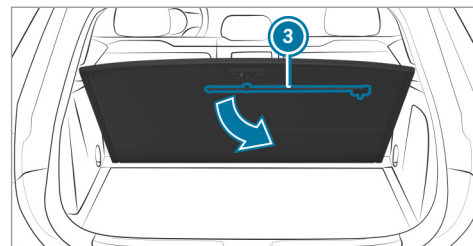

- ▶ Pull rod ③ from the bracket on the underside of the cargo compartment floor and turn it as far as it will go.

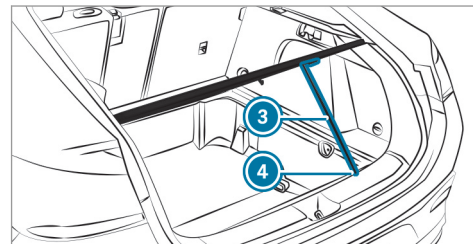

- ▶ Position rod ③ in the corner of cargo compartment floor ④.

### Closing

- ▶ Remove rod ③ from the corner of cargo compartment floor ④.
- ▶ Fasten rod ③ to the bracket on the underside of the cargo compartment floor.
- ▶ Fold the cargo compartment floor downwards.
- ▶ Press the cargo compartment floor down until it engages.

### Locking and unlocking the cargo compartment floor

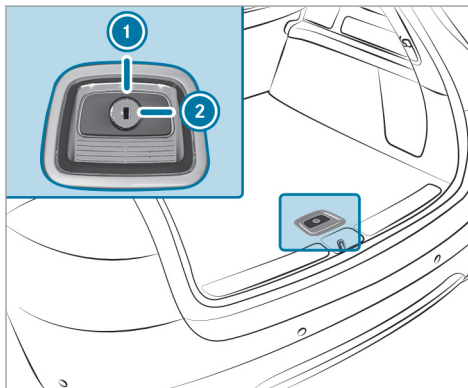

- ▶ Turn the emergency key a quarter turn clockwise ② (to lock) or counter-clockwise ① (to unlock).

### Attaching a roof luggage rack

**⚠ WARNING** Risk of accident due to exceeding the maximum roof load

The vehicle center of gravity and the usual driving characteristics as well as the steering and braking characteristics alter.

If you exceed the maximum roof load, the driving characteristics, as well as steering and braking, will be greatly impaired.

- ▶ Never exceed the maximum roof load and adjust your driving style.

You will find information on the maximum roof load in the "Technical data" section.

**! NOTE** Vehicle damage from non-approved roof luggage racks

The vehicle could be damaged by roof luggage racks that have not been tested and approved for Mercedes-Benz.

- ▶ Use only roof luggage racks tested and approved for Mercedes-Benz.

- ▶ Depending on the vehicle equipment, ensure that the sliding sunroof can be fully raised when the roof luggage rack is installed.
- ▶ Depending on the vehicle equipment, ensure that the trunk lid can be fully opened when the roof luggage rack is installed.
- ▶ Position the load on the roof luggage rack in such a way that the vehicle will not sustain damage even when it is in motion.

**!** **NOTE** Damage to the panorama roof with power tilt/sliding panel due to non-approved roof luggage racks

The panorama roof with power tilt/sliding panel may be damaged by the roof luggage rack if you attempt to open it when using a roof luggage rack not tested and approved for Mercedes-Benz.

- ▶ When a roof luggage rack is installed, open the panorama roof with power tilt/sliding panel only if this has been

tested and approved for Mercedes-Benz.

The panorama roof with power tilt/sliding panel may be raised to allow ventilation of the vehicle interior.

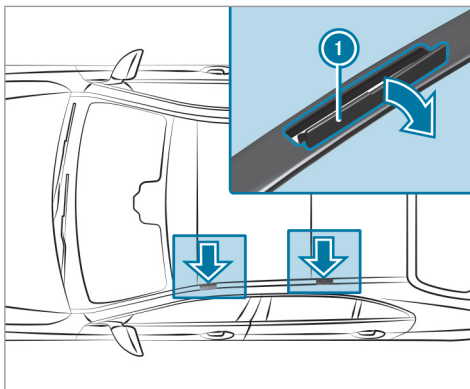

**!** **NOTE** Damage to the covers

The covers may be damaged and scratched when being opened.

- ▶ Do not use metallic or hard objects.

- ▶ Carefully fold covers ① upwards in the direction of the arrow.
- ▶ Secure the roof luggage rack to the fastening points beneath covers ①.
- ▶ Comply with the installation instructions of the roof luggage rack manufacturer.
- ▶ Secure the load on the roof luggage rack.

### Cup holder

**Switching the cooling or heating function for the temperature-controlled cup holder on or off**

**!** **WARNING** Risk of injury by touching the heating elements

The cup holder's heating elements may be very hot.

You can burn yourself on them.

- ▶ Do not touch the cup holder's hot heating elements.
- ▶ Ensure that no children can access the cup holder's hot heating elements.
- ▶ Never leave children unattended in the vehicle.

**!** **NOTE** Damage to objects in the temperature-controlled cup holder

If you place objects into the temperature-controlled cup holder, they may become damaged.

- ▶ Do not place objects into the temperature-controlled cup holder.

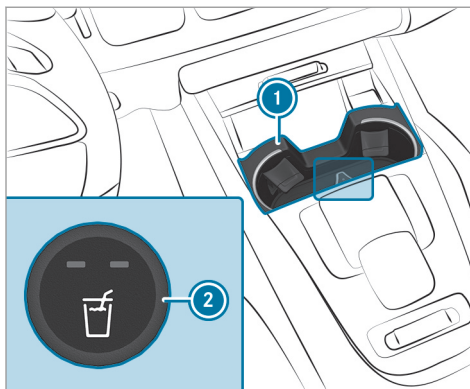

Cup holder in the front center console

- ▶ **To switch on:** on cup holder ①, press button ② repeatedly until the blue (keep cool) or red (keep warm) indicator lamp on the button lights up.  
If you use the heating function, the metal insert of the cup holder is heated. Once a certain temperature has been reached, the warning lamp lights up. Do not reach into the

cup holder's metal insert when the warning lamp is lit.

- ▶ **To switch off:** press button ② repeatedly until the indicator lamp on the button goes out.
- ① Clean the removable rubber mat only with clean, lukewarm water and the cup holder only with a soft cloth.

## Sockets

### Using the 12 V socket in the front center console

#### Requirements:

- Only connect devices up to a maximum of 240 W (20 A).

Depending on the vehicle equipment, the vehicle has the following 12 V sockets:

- In the storage compartment in the front center console
- In the cargo compartment

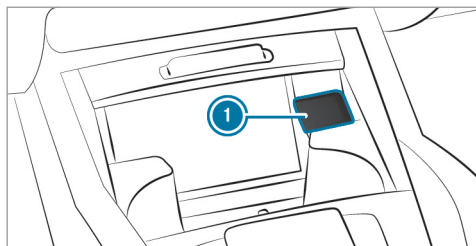

Example: 12 V socket in the storage compartment in the front center console

- ▶ Lift up cap ① of the socket and insert the plug of the device.

If you have connected a device to the 12 V socket, leave the cover of the storage compartment open.

### Using the 115 V socket in the rear passenger compartment

- ▶ **⚠ DANGER** Risk of fatal injury due to damaged connecting cables or sockets

You could receive an electric shock if the connecting cable or the 115 V power socket is pulled out of the trim or is damaged or wet.

- ▶ Use only connecting cables that are dry and free of damage.
- ▶ When the ignition is switched off, make sure that the 115 V power socket is dry.
- ▶ Immediately have the 115 V power socket checked or replaced at a qualified specialized workshop if it is damaged or has been pulled out of the trim.
- ▶ Never plug the connecting cable into a 115 V power socket that is damaged or has been pulled out of the trim.

- ▶ **⚠ DANGER** Risk of fatal injury due to incorrect handling of the socket

You could receive an electric shock in particular:

- If you reach into the socket.
- If you insert unsuitable devices or objects into the socket.
- ▶ Do not reach into the socket.
- ▶ Only connect suitable devices to the socket.

#### Requirements:

- Only connect devices with a suitable plug which conforms to the standards specific to the country you are in.
- Only connect devices up to a maximum of 150 W (1.3 A).
- Do not use multiple socket outlets.

Depending on the vehicle equipment, the design of the center console and storage compartment may differ.



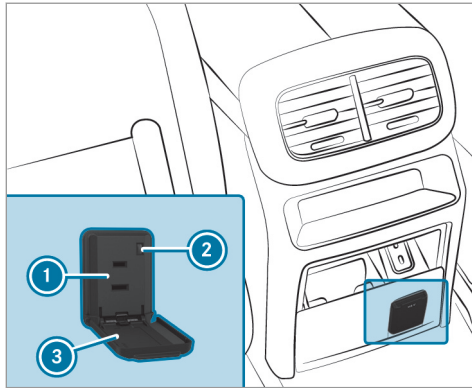

- ▶ Mercedes-Maybach vehicles with individual seats in the rear passenger compartment: open the storage compartment of the rear center console .
- ▶ Open flap ③ .
- ▶ Insert the plug of the device into 115 V socket ① .  
When the on-board electrical system voltage is sufficient, indicator lamp ② lights up.

### Overview of USB ports

Depending on the vehicle equipment, the vehicle has the following USB ports:

- In the storage compartment of the cockpit armrest (→ page 104)
- In the front center console next to the mobile phone storage compartment
- In the rear passenger compartment center console

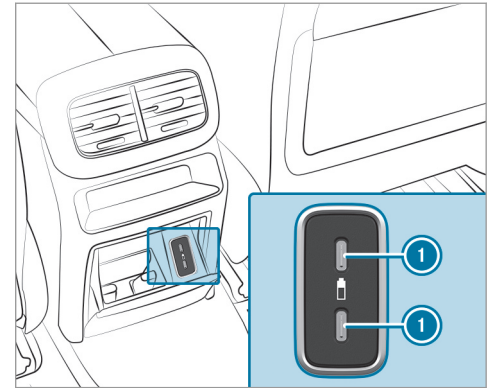

Example: USB ports in the center console in the rear passenger compartment

If the ignition is switched on you can charge USB devices, e.g. mobile phones, at USB ports. The charging voltage is approximately 5 V (up to 3 A).

### Wireless charging of the mobile phone and connection with the exterior antenna

#### Notes on wirelessly charging the mobile phone

**⚠ WARNING** Risk of injury due to objects being stowed incorrectly

If objects in the vehicle interior are stowed incorrectly, they can slide or be thrown around and hit vehicle occupants. In addition, cup holders, open stowage spaces and mobile phone receptacles cannot always retain all objects within.

There is a risk of injury, particularly in the event of sudden braking or a sudden change in direction.

- ▶ Always stow objects so that they cannot be thrown around in such situations.
- ▶ Always make sure that objects do not protrude from stowage spaces, parcel nets or stowage nets.

- ▶ Close the lockable stowage spaces before starting a journey.
- ▶ Always stow and secure heavy, hard, pointed, sharp-edged, fragile or bulky objects in the trunk/cargo compartment.

Observe the notes on loading the vehicle.

**⚠ WARNING** Risk of fire from placing objects in the mobile phone storage compartment

Placing other objects in the mobile phone storage compartment could constitute a fire hazard.

- ▶ Apart from a mobile phone, do not place any other objects in the mobile phone storage compartment, especially those made of metal.

**! NOTE** Damage to objects caused by placing them in the mobile phone storage compartment

If objects are placed in the mobile phone storage compartment, they may be damaged by electromagnetic fields.

- ▶ Do not place credit cards, data storage devices, ski passes or other objects sensitive to electromagnetic fields in the mobile phone storage compartment.

**! NOTE** Damage to the mobile phone stowage compartment caused by liquids

If liquids enter the mobile phone stowage compartment, the compartment may be damaged.

- ▶ Ensure that no liquids enter the mobile phone stowage compartment.

Always observe the notes for persons with electronic medical aids (→ page 29).

- Depending on the vehicle equipment, the mobile phone is connected to the vehicle's exterior antenna via the charging module.
- The charging function and wireless connection of the mobile phone to the vehicle's exterior antenna are only available if the ignition is switched on.
- Small mobile phones may not be able to be charged in every position of the mobile phone storage compartment.
- Large mobile phones which do not rest flat in the mobile phone storage compartment may not be able to be charged or connected with the vehicle's exterior antenna.
- The mobile phone may heat up during the charging process. This may also depend on the applications (apps) currently open in the background.
- To ensure more efficient charging and connection with the vehicle's exterior antenna, remove the protective cover from the mobile phone. Protective covers which are necessary for wireless charging are excluded.

### Wireless charging of a mobile phone in the cockpit

#### Requirements:

- The mobile phone is suitable for wireless charging.
- ① A list of compatible mobile phones can be found at: <https://www.mercedes-benz-mobile.com/>

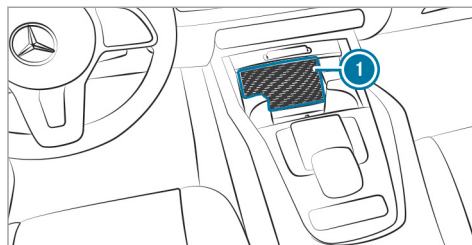

- ▶ Place the mobile phone as close to the center of mat ① as possible with the display facing upwards. When a message is shown in the multimedia system, the mobile phone is being charged.

Malfunctions detected during the charging process are shown in the multimedia system display.

- ① The mat can be removed for cleaning, e.g. using clean, lukewarm water.

### Installing/removing the floor mats

**⚠ WARNING** Risk of accident due to objects in the driver's footwell

Objects in the driver's footwell may impede pedal travel or block a depressed pedal. This jeopardizes the operating and road safety of the vehicle.

- ▶ Stow all objects in the vehicle securely so that they cannot get into the driver's footwell.
- ▶ Always install the floor mats securely and as prescribed in order to ensure that there is always sufficient room for the pedals.

- ▶ Do not use loose floor mats and do not place floor mats on top of one another.

### Installing floor mats

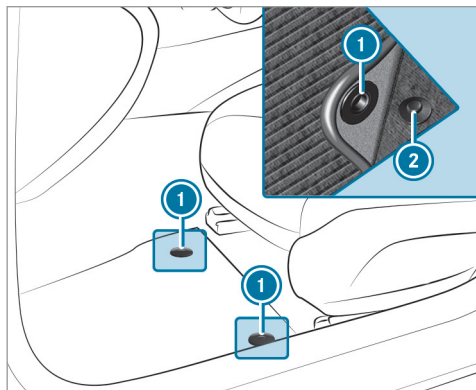

- ▶ Move the corresponding seat backwards and lay the floor mat in the footwell.
- ▶ Press studs ① onto holders ②.
- ▶ Adjust the corresponding seat.

### Removing floor mats

- ▶ **To remove:** pull the floor mat off the holders ②.
- ▶ Remove the floor mat.

## Exterior lighting

### Information about lighting systems and your responsibility

The various lighting systems of the vehicle are only aids. The driver of the vehicle is responsible for correct vehicle illumination in accordance with the prevailing light and visibility conditions, legal requirements and traffic situation.

## Light switch

### Operating the light switch

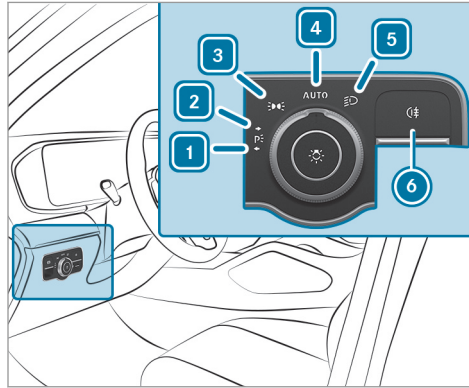

- 1 Left-hand standing lamps
- 2 Right-hand standing lamps
- 3 Parking lamps and license plate lamp
- 4 **AUTO** Automatic driving lights (preferred light switch position)

- 5 Low beam/high beam
- 6 Switches the rear fog light on/off

When low beam is activated, the indicator lamp for the parking lamps will be deactivated and replaced by the low-beam indicator lamp.

▶ Always park your vehicle safely using sufficient lighting, in accordance with the relevant legal stipulations.

**!** **NOTE** Battery discharging by operating the standing lights

Operating the standing lights over a period of hours puts a strain on the battery.

▶ Where possible, switch on the right or left parking light.

In the event of severe battery discharging, the parking lamps or standing lamps will be switched off automatically to facilitate the next engine start.

## 122 Light and visibility

The exterior lighting (except standing and parking lamps) will switch off automatically when the driver's door is opened.

- Observe the notes on surround lighting (→ page 126).

### Automatic driving lights function

The parking lamps, low beam and daytime running lamps are switched on automatically depending on the ignition status and the ambient light.

#### **⚠ WARNING** Risk of accident when the low beam is switched off in poor visibility



When the light switch is set to **AUTO**, the low beam may not be switched on automatically if there is fog, snow or other causes of poor visibility such as spray.

- ▶ In such cases, turn the light switch to .

The automatic driving lights are only an aid. You are responsible for vehicle lighting.

### Switching the rear fog lamps on or off

**Requirements:**

- The light switch is in the  or **AUTO** position.
- ▶ Press the  button.

Please observe the country-specific laws on the use of rear fog lamps.

- ⓘ Vehicles with AIRMATIC or E-ACTIVE BODY CONTROL with off-road package: when the rear fog lamp is switched on, off-road level +3 will not be available. If the rear fog lamp is switched on and off-road level +3 is activated, the vehicle will be lowered to off-road level +2.

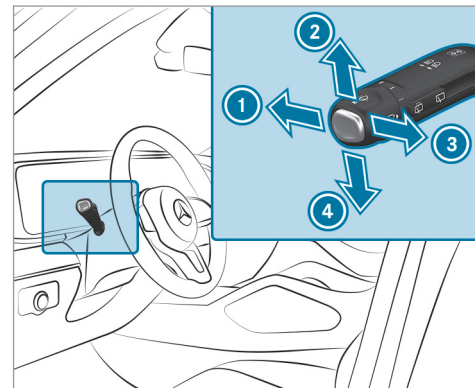

### Operating the combination switch for the lights



- ① High beam
- ② Turn signal light, right
- ③ High-beam flasher
- ④ Turn signal light, left

- ▶ Use the combination switch to activate the desired function.

### High beam

- ▶ **To switch on:** turn the light switch to the  or **AUTO** position.
- ▶ Push the combination switch in the direction of arrow ①. When the high beam is activated, the  indicator lamp for low beam is deactivated and replaced by the  indicator lamp for high beam.
- ▶ **To switch off:** push the combination switch in the direction of arrow ① or pull it in the direction of arrow ③.

### High-beam flasher

- ▶ Pull the combination switch in the direction of arrow ③.

### Turn signal light

- ▶ **To indicate briefly:** push the combination switch briefly to the point of resistance in the direction of arrow ② or ④. The corresponding turn signal light will flash three times.

- ▶ **To indicate permanently:** push the combination switch beyond the point of resistance in the direction of arrow ② or ④.

Vehicles with Active Lane Change Assist:

- Indicator operation activated by the driver can extend for the duration of the lane change.
- If the driver indicated directly beforehand but a lane change was not immediately possible, the turn signal indicator may activate automatically.

### Activating/deactivating the hazard warning lights

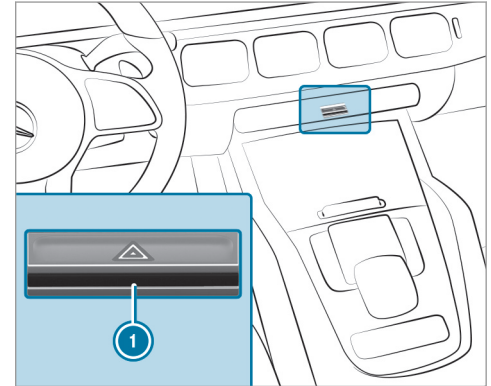

- ▶ Press button ①.

The hazard warning lights will switch on automatically if:

- The airbag has been deployed.

When the indicator is activated, the hazard warning lights are interrupted.

## Cornering light

### Cornering light function

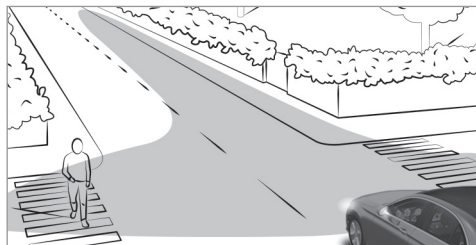

The cornering light improves the illumination of the road over a wide angle in the turning direction, enabling better visibility on tight curves, for example. It can be activated only when the low beam is switched on.

The function is active in the following cases:

- At speeds below 25 mph (40 km/h) when the turn signal light is switched on or the steering wheel is turned

- At speeds between 25 mph (40 km/h) and 43 mph (70 km/h) and when the steering wheel is turned

**Roundabout and intersection function:** the cornering light will be activated on both sides based on an evaluation of the vehicle's current GPS position. It will remain active until after the vehicle has left the roundabout or the intersection.

## Adaptive Highbeam Assist

### Adaptive Highbeam Assist function

**⚠ WARNING** Risk of accident despite Adaptive Highbeam Assist

Adaptive Highbeam Assist does not react to:

- Road users without lights, e.g. pedestrians
- Road users with poor lighting, e.g. cyclists
- Road users whose lighting is obstructed, e.g. by a barrier

On very rare occasions, Adaptive Highbeam Assist may fail to recognize other road users with their own lighting, or may recognize them too late.

In these, or in similar situations, the automatic high beam will not be deactivated or will be activated despite the presence of other road users.

- ▶ Always observe the road and traffic conditions carefully and switch off the high beam in good time.

### System limits

Adaptive Highbeam Assist cannot take into account road, weather or traffic conditions.

Detection may be restricted in the following cases:

- In poor visibility, e.g. fog, heavy rain or snow
- If there is dirt on the sensors or the sensors are obscured

Adaptive Highbeam Assist is only an aid. You are responsible for adjusting the vehicle's lighting to



the prevailing light, visibility and traffic conditions.

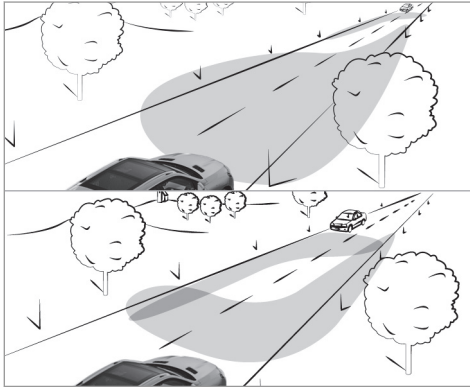

The Adaptive Highbeam Assist automatically switches between the following types of light:

- Low beam
- High beam

At speeds greater than 19 mph (30 km/h):

- If no other road users are detected, the high beam will be switched on automatically.

The high beam switches off automatically in the following cases:

- At speeds below 16 mph (25 km/h).
- If other road users are detected.
- If street lighting is sufficient.

At speeds greater than approximately 31 mph (50 km/h):

- The headlamp range of the low beam is regulated automatically based on the distance to other road users.

The system's optical sensor is located behind the windshield near the overhead control panel.

#### Switching Adaptive Highbeam Assist on/off



- ▶ **To switch on:** turn the light switch to the **AUTO** position.

- ▶ Switch on the high beam using the combination switch.  
When the high beam is switched on automatically in the dark, the  indicator lamp on the multifunction display will light up.
- ▶ **To switch off:** switch off the high beam using the combination switch.

#### Switching the daytime running lamps on/off

Multimedia system:

- ▶  ▶ Settings ▶ Light
- ▶ ▶ Daytime Run. Lights

- ▶ Activate  or deactivate  the function.

#### Setting the exterior lighting switch-off delay time

Requirements:

- The light switch is in the **AUTO** position.

Multimedia system:

-  » Settings » Light
- » Exterior Lighting Delay

▶ Set the switch-off delay time.  
When the vehicle engine is switched off, the exterior lighting will be activated for the set time.

### Switching the surround lighting on/off

Multimedia system:

-  » Settings » Light
- » Locator Lighting

When **Locator Lighting** is active, the exterior lighting lights up for 40 seconds after the vehicle is unlocked. When you start the vehicle, the surround lighting is deactivated and the automatic driving lights are activated.

**Illuminated running boards:** when the surround lighting is switched on, the illumination of the running boards is activated when a door is opened. If the door is not closed, the running board courtesy lighting is automatically deactivated after 40 seconds.





▶ Activate or deactivate the function.

### Interior lighting

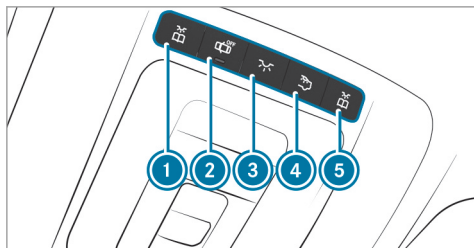
#### Adjusting the interior lighting

##### Front overhead control panel



- ①  Front left reading lamp
- ②  Automatic interior lighting control
- ③  Front interior lighting
- ④  Rear interior lighting
- ⑤  Front right reading lamp

▶ **To switch on or off:** press button ① - ⑤ accordingly.

##### Control panel in the rear compartment

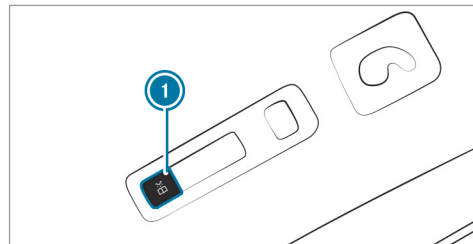

- ①  Rear reading lamp

▶ **To switch on or off:** press button ①.

### Adjusting the ambient lighting

Multimedia system:

-  » Settings » Light
- » Ambient Lighting

#### Setting the color

- ▶ Select **Color**.
- ▶ Set the desired color.

#### Adjusting the brightness

- ▶ Select **Brightness**.

Adjust the brightness.

#### Activating the brightness for zones

- ▶ Select **Brightness**.
- ▶ Select **Brightness Zones**.

#### Activating multi-color lighting

- ▶ Select **Color**.
- ▶ Select **Multi-color**.
- ▶ Select a color combination.

#### Activating multi-color animation

- ▶ Select **Color**.
- ▶ Select **Multi-color Animation**.  
The chosen color combination will change at predefined intervals.

#### Activating welcome lighting

- ▶ Select **Color**.
- ▶ Select **Welcome**.  
When the vehicle is unlocked, a special ambient lighting sequence will run.

#### Activating dependency on air conditioning settings

- ▶ Select **Color**.
- ▶ Select **Climate**.  
If changes are made to the temperature setting in the vehicle, the color of the ambient lighting will change briefly.

### Switching the interior lighting switch-off delay time on/off

Multimedia system:

-  » Settings » Light
- » Interior Lighting Delay

- ▶ Switch the switch-off delay time on or off.  
When this function is active, the interior lighting lights up for a short time after the vehicle is locked.

## Windshield wiper and windshield washer system

### Switching the windshield wipers on/off

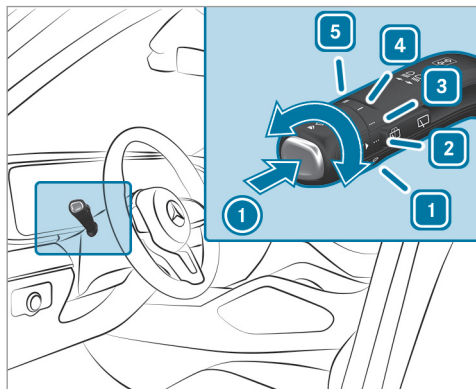

- 1** **0** Windshield wipers off
- 2** **...** Automatic wiper, normal
- 3** **...** Automatic wiper, frequent

- 4** **—** Continuous wiping, slow
- 5** **==** Continuous wiping, fast

▶ Turn the combination switch to the correct position **1** - **5**.

▶ **Single wipe/washing:** push the button on the combination switch in the direction of arrow **1**.

- Single wipe
- Wipes with washer fluid

**Vehicles with MAGIC VISION CONTROL:** in position **2** or **3**, the windshield washing process is automatically triggered if dirt is detected on the windshield unless the **Check Washer Fluid** message is being displayed.

### Changing the windshield wiper blades

**⚠ WARNING** Risk of becoming trapped if the windshield wipers are switched on while wiper blades are being replaced

If the windshield wipers begin to move while you are changing the wiper blades, you can be trapped by the wiper arm.

- ▶ Always switch off the windshield wipers and the ignition before changing the wiper blades.

### Moving the wiper arms into the replacement position

- ▶ Switch the ignition on and switch off again immediately.
- ▶ Within around 15 seconds, press and hold the button on the combination switch for approximately three seconds (→ page 128). The wiper arms will move into the replacement position.

### Removing the wiper blades

- ▶ Fold the wiper arms away from the windshield.

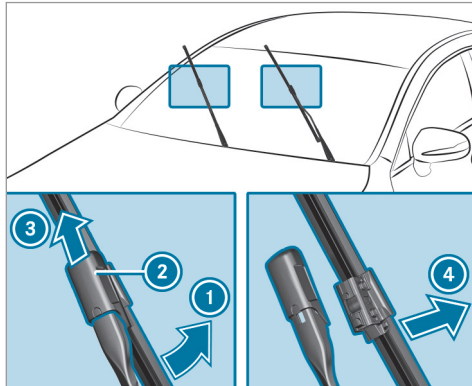

- ▶ Hold the wiper arm with one hand. With the other hand, turn the wiper blade in the direction of arrow ① away from the wiper arm as far as it will go.

- ▶ Slide catch ② in the direction of arrow ③ until it engages in the removal position.
- ▶ Remove the wiper blade from the wiper arm in the direction of arrow ④.

### Installing the wiper blades

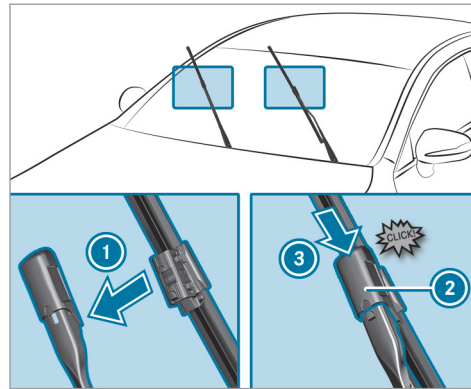

- ▶ Insert the new wiper blade into the wiper arm in the direction of arrow ①.

- ▶ Slide catch ② in the direction of arrow ③ until it engages in the locking position.
- ▶ Make sure that the wiper blade is seated correctly.
- ▶ Fold the wiper arms back onto the windshield.
- ▶ Switch on the ignition.
- ▶ Press the  button on the combination switch. The wiper arms will move into the original position.
- ▶ Switch the ignition off.

### Maintenance display

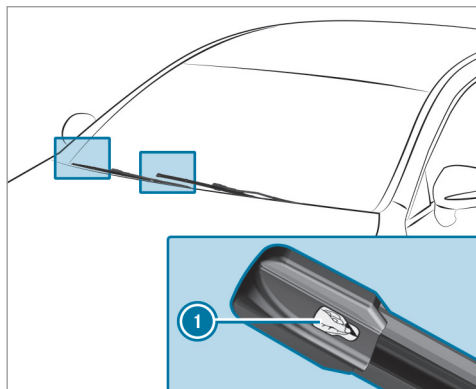

- ▶ Remove protective film ❶ from the maintenance display on the tip of the newly installed wiper blades.

When the color of the maintenance display changes from black to yellow, the wiper blades should be replaced.

- ❶ The duration until the color changes varies depending on the usage conditions.

### Replacing the windshield wiper blades (MAGIC VISION CONTROL)

#### Moving the wiper arms into the replacement position

- ▶ Switch off the ignition.
- ▶ Within around 15 seconds, press the button on the combination switch  (→ page 128). The wiper arms will move into the replacement position.

### Removing the wiper blades

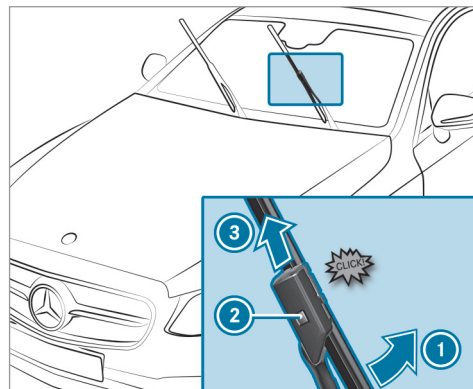

- ▶ **To bring the wiper blade into position to be removed:** hold the wiper arm firmly in one hand. With the other hand, turn the wiper blade in the direction of arrow ❶ beyond the point of resistance ❷. The wiper blade will engage in the removal position with a click.

- ▶ **To remove the wiper blade:** press release knob ②, pull the wiper blade in the direction of arrow ③ and remove.

### Installing the wiper blades

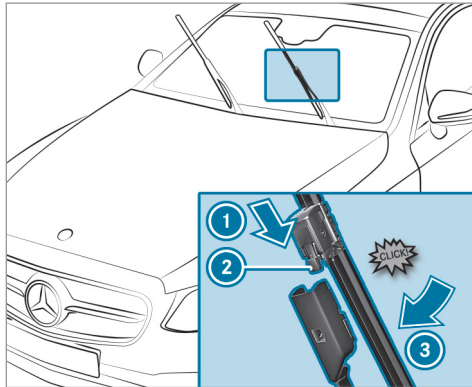

- ▶ Push the new wiper blade onto the wiper arm in the direction of arrow ① until release knob ② engages.

- ▶ Press the wiper blade onto the wiper arm in the direction of arrow ③ beyond the point of resistance. The wiper blade will engage with a noticeable click and move freely again.
- ▶ Fold the wiper arm back onto the windshield.

## Mirrors

### Operating the outside mirrors

- ⚠ **WARNING** Risk of accident due to adjusting vehicle settings while the vehicle is in motion

You could lose control of the vehicle in the following situations in particular:

- If you adjust the driver's seat, the head restraints, the steering wheel or the mirror while the vehicle is in motion.
- If you fasten your seat belt while the vehicle is in motion.
- ▶ Before starting the engine: adjust the driver's seat, the head restraints, the

steering wheel and the mirror and fasten your seat belt.

- ⚠ **WARNING** Risk of accident due to misjudgment of distance when using the front-passenger mirror

The outside mirror on the front passenger side reflects objects on a smaller scale.

- ▶ Therefore, always look over your shoulder in order to ensure that you are aware of the actual distance between you and the road users driving behind you.

### Folding the outside mirrors in/out

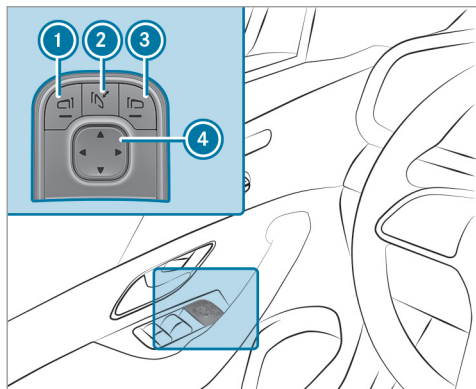

- ▶ Briefly press button ②.

ⓘ If the battery has been disconnected or has discharged, the outside mirrors must be moved briefly using button ②. Only then will the automatic mirror folding function work properly.

### Adjusting the outside mirrors

- ▶ Press button ① or ③ to select the outside mirror to be adjusted.
- ▶ Press button ④ to adjust the position of the mirror glass.

### Engaging the outside mirrors

If an outside mirror has been forcibly disengaged, proceed as follows.

- ▶ Vehicles without electrically folding outside mirrors: manually move the outside mirror into the correct position.
- ▶ Vehicles with electrically folding outside mirrors: press and hold button ②. You will hear a click and the mirror will audibly click into place. The outside mirror will now be set to the correct position.

### Automatic anti-glare mirrors function

**⚠ WARNING** Risk of acid burns and poisoning due to the anti-glare mirror electrolyte

Electrolyte may escape if the glass in an automatic anti-glare mirror breaks.

The electrolyte is hazardous to health and causes irritation. It must not come into contact with your skin, eyes, respiratory organs or clothing or be swallowed.

- ▶ If you come into contact with electrolyte, observe the following:
  - Immediately rinse the electrolyte from your skin with water and seek medical attention.
  - If electrolyte comes into contact with your eyes, immediately rinse them thoroughly with clean water and seek medical attention.
  - If the electrolyte is swallowed, immediately rinse your mouth out thoroughly. Do not induce vomiting. Seek medical attention immediately.



- Immediately change out of clothing which has been contaminated with electrolyte.
- If an allergic reaction occurs, seek medical attention immediately.

The inside rearview mirror and the outside mirror on the driver's side will automatically go into anti-glare mode if light from a headlamp hits the sensor on the inside rearview mirror.

### System limits

The system will not go into anti-glare mode if:

- The engine is switched off.
- Reverse gear is engaged.
- The interior lighting is switched on.

### Front-passenger outside mirror parking position function

- ⓘ The parking position is available only in vehicles with a memory function.

The parking position makes parking easier.

In the following situations, the front-passenger outside mirror will swivel downwards in the direction of the rear wheel on the front passenger's side:

- The parking position is stored (→ page 133)
- The front-passenger mirror is selected
- Reverse gear is engaged.

The front-passenger outside mirror will move back to its original position in the following situations:

- You shift the transmission to another transmission position
- You are traveling at speeds greater than 9 mph (15 km/h)
- You press the button for the outside mirror on the driver's side

### Storing and calling up the parking position of the front-passenger outside mirror

#### Storing

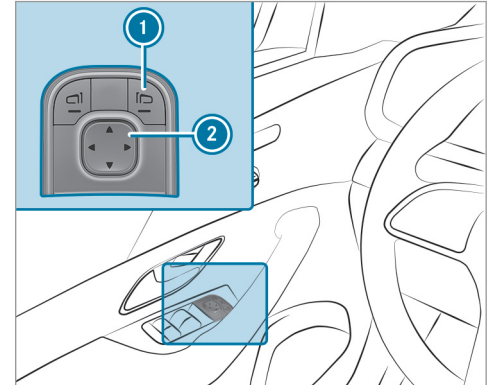

- ▶ Select the front-passenger outside mirror using button ①.
- ▶ Engage reverse gear.
- ▶ Move the front-passenger outside mirror into the desired parking position using button ②.

### Calling up

- ▶ Select the front-passenger outside mirror using button ①.
- ▶ Engage reverse gear.  
The front-passenger outside mirror will move to the stored parking position.

### Activating/deactivating the automatic mirror folding function

Multimedia system:

- ▶  ▶ Settings ▶ Vehicle
- ▶ Switch **Automatic Folding** on or off.

### Area permeable to radio waves on the windshield

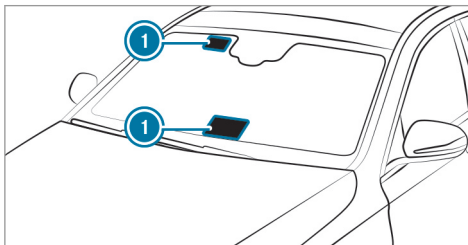

Radio-controlled equipment, such as toll systems, can be mounted only on areas ① of the windshield that are permeable to radio waves.

Areas permeable to radio waves ① are best visible from outside the vehicle when the windshield is illuminated with an external light source.

Note this position for vehicles with:

- Windshield heating
- Infrared reflective windshield

### Infrared-reflective windshield function

The infrared-reflective windshield is coated and reduces the build-up of heat in the vehicle interior.

The coating shields the vehicle interior from radio waves.

## Overview of climate control systems

### Notes on climate control

An interior air filter in combination with the pre-filter in the engine compartment must always be used so that the air conditioning system, pollution level monitoring and the air filtration work correctly. Make sure that the filter is installed correctly and the filter housing in the engine compartment is closed correctly using the cap and always tightly sealed when in operation. Use filters recommended and approved by Mercedes-Benz. Always have service work carried out at a qualified specialist workshop.

### Overview of the air conditioning control panel

The indicator lamps on the buttons indicate that the corresponding function is activated.

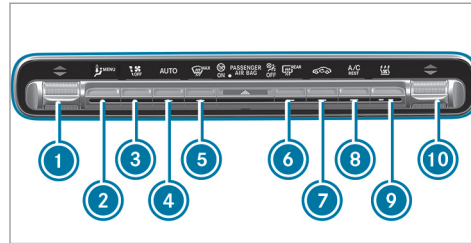

Example: control panel for dual-zone automatic climate control with stationary heater

- ① Sets the driver's side temperature
- ② Calls up/exits the air conditioning menu  
Pressing and holding (approx. four seconds): resets climate control to the basic settings
- ③ Sets the airflow or switches off climate control
- ④ Sets climate control to automatic mode (→ page 137)
- ⑤ Defrosts the windshield
- ⑥ Switches the rear window heater on/off

- ⑦ Switches air-recirculation mode on/off (→ page 138)
- ⑧ Switches the A/C function on/off (→ page 136)  
Switches residual heat on/off (→ page 138)
- ⑨ Vehicles with control panel for dual-zone automatic climate control or 3-zone automatic climate control without stationary heater: switches synchronization on/off (→ page 137)  
Vehicles with control panel for dual-zone automatic climate control or 3-zone automatic climate control with stationary heater: switches stationary heater on/off
- ⑩ Sets the temperature on the front passenger side

## Overview of the rear operating unit

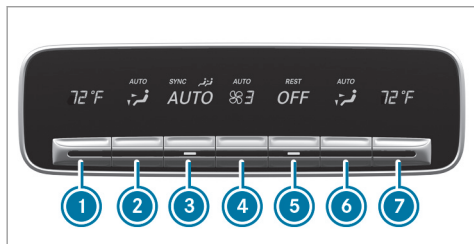

Example: USA

- ① Sets the temperature, left
- ② Sets the air distribution, left
- ③ Sets climate control to automatic mode (→ page 137)
- ④ Sets the airflow
- ⑤ Switches climate control on/off (→ page 136)  
Switches the residual heat on/off (→ page 138)
- ⑥ Sets the air distribution, right
- ⑦ Sets the temperature, right

## Operating the climate control system

### Switching climate control on/off

- ▶ **To switch on:** set the airflow to level 1 or higher using the button.
  - ▶ **To switch off:** set the airflow to level 0 using the button.
- ⓘ If climate control is switched off, the windows may fog up more quickly. Switch off climate control only briefly.

### Switching the climate control in the rear passenger compartment on/off

- ▶ Press button ⑤.
- ⓘ When climate control in the second seat row is switched off, the indicator lamp is activated and **OFF** is shown on the rear display.

### Switching the A/C function on or off via the control panel

The A/C function heats, cools and dehumidifies the vehicle's interior air.

- ▶ Press the button.

Switch off the A/C function only briefly; otherwise, the windows may fog up more quickly.

Condensation may drip from the underside of the vehicle when cooling mode is active. This is not a sign that there is a malfunction.

### Calling up the air conditioning menu

#### Calling up the air conditioning menu using the multimedia system

- ▶ Select one of the temperature displays at the lower edge of the media display.

#### Activating/deactivating the A/C function via the multimedia system

The A/C function heats, cools and dehumidifies the vehicle's interior air.

- ▶ Call up the air-conditioning menu (→ page 136).
- ▶ Select **First Row of Seats**.
- ▶ Select **A/C**.

### Setting climate control to automatic mode

In automatic mode, the set temperature is controlled and maintained at a constant level by the air supply.

- ▶ Press the **AUTO** button.
- ▶ **To switch to manual mode:** press the **AUTO** button.

In automatic mode, you can choose between five different air quantities using the  button. Automatic mode is retained.





### Automatically controlling the climate control in the rear passenger compartment

In automatic mode, the set temperature is regulated by the temperature of the dispensed air and the airflow.

- ▶ Press the **AUTO** button (→ page 136).

### Setting the air distribution

- ▶ Call up the air conditioning menu (→ page 136).

- ▶ Select a row of seats.
- ▶ **To set the air distribution:** select ,  or .
- ▶ Set the airflow.
- ▶ **i** Several air distribution options can be selected at the same time, for example to set the climate control for the windshield and the footwells simultaneously. The  climate control for the windshield can only be selected for the first seat row.

### Setting climate control for the rear passenger compartment (multimedia system)

#### Setting the temperature

- ▶ Call up the air conditioning menu (→ page 136).
- ▶ Select **Second Row of Seats**.
- ▶ Set the temperature.

### Setting the airflow

- ▶ Call up the air conditioning menu (→ page 136).
- ▶ Select **Second Row of Seats**.
- ▶ Set the airflow.

### Controlling the rear climate control automatically

- ▶ Select **REAR AUTO**.  
Rear climate control is controlled automatically.

### Deactivating rear climate control

- ▶ Select **REAR OFF**.  
Rear climate control is deactivated.

### Activating/deactivating the climate control synchronization function via the control panel

Climate control can be set centrally using the synchronization function. The temperature and air distribution setting for the driver's side will be adopted automatically for all climate control zones.

## 138 Climate control

- ▶ Press the **SYNC** button.

The synchronization function will be deactivated if the settings for one of the other climate zones are changed.

### Activating/deactivating the climate control synchronization function via the multimedia system

Climate control can be set centrally using the synchronization function. The driver's settings for temperature, air quantity and air distribution are adopted automatically for all climate zones.

- ▶ Call up the air conditioning menu (→ page 136).
- ▶ Select **First Row of Seats**.
- ▶ Select **SYNC**.

### Removing condensation from the windows

#### Windows fogged up on the inside

- ▶ Press the **AUTO** button.

- ▶ If the windows continue to fog up: press the  button.

#### Windows fogged up on the outside

- ▶ Switch on the windshield wipers.
- ▶ Press the **AUTO** button.

### Switching air-recirculation mode on/off

- ▶ Press the  button.  
The interior air will be recirculated.

Air-recirculation mode automatically switches to fresh air mode after some time.

- ⓘ If air-recirculation mode is switched on, the windows may fog up more quickly. Switch on air-recirculation mode only briefly.

### Switching the residual heat on or off

#### Requirements:

- The vehicle is parked.

It is possible to make use of the residual heat from the engine to continue heating or ventilating the front compartment of the vehicle for

approximately 30 minutes, depending on the temperature set.

- ▶ **To activate:** press  button.

Residual heat will be switched off automatically.

### Switching the residual heat in the rear passenger compartment on/off

#### Requirements:

- The vehicle is parked.

When the residual heat of the engine is activated in the rear compartment, you can heat or ventilate the rear passenger compartment for approximately 30 minutes.

- ▶ Press button  (→ page 136).

### Activating/deactivating ionization

Ionization improves the quality of the vehicle's interior air. Ionization of the interior air is odorless.

- ▶ Call up the air conditioning menu (→ page 136).

- ▶ Select **Air Quality**.
- ▶ Select **IONIZATION**.

### Fragrance system

#### Setting the fragrance system Requirements:

- Automatic climate control is activated.
- The glove box is closed.

The fragrance system distributes a pleasant fragrance throughout the vehicle interior from a flacon located in the glove box.

- ▶ Call up the climate control menu (→ page 136).
- ▶ Select **Air Quality**.
- ▶ Select **AIR FRESHENER**.
- ▶ Keep pressing until the desired intensity is reached.

#### Inserting or removing the flacon of the fragrance system

**⚠ WARNING** Risk of injury from liquid perfume

If children open the flacon, they could drink the liquid perfume or it could come into contact with their eyes.

- ▶ Do not leave children unattended in the vehicle.
- ▶ Consult a doctor immediately if liquid perfume has been drunk.
- ▶ If liquid perfume comes into contact with your eyes or skin, rinse your eyes with clean water.
- ▶ If symptoms continue, consult a doctor.



**ENVIRONMENTAL NOTE** Environmental damage due to improper disposal of full flacons



Full flacons must not be disposed of with household waste.



Full flacons must be taken to a harmful substance collection point.

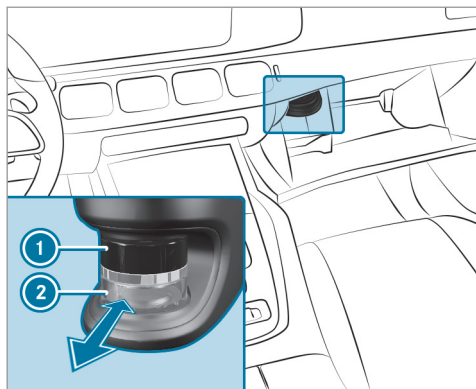

- ① Cap
- ② Flacon

- ▶ **To insert:** slide the flacon into the holder as far as it will go.
- ▶ **To remove:** after opening the glove box, wait for approximately seven seconds and pull out the flacon.

If you do not use genuine Mercedes-Benz interior perfumes, observe the manufacturers' safety notices on the perfume packaging.

Dispose of the genuine Mercedes-Benz interior perfume flacon when it is empty and do not refill it.

#### Refillable flacon

- ▶ Unscrew the cap of the empty flacon.
- ▶ Fill the flacon with a maximum of 0.5 fl. oz. (15 ml).
- ▶ Screw the cap back on to the flacon.

Always refill the empty refillable flacon with the same perfume. Observe the separate information sheet with the flacon.

#### Information on the windshield heater

The windshield heater is switched on automatically if the  button is activated. In addition, it is automatically switched on when necessary.

## Air vents

### Adjusting the front air vents

**⚠ WARNING** Risk of burns and frostbite due to being too close to the air vents

Very hot or very cold air can flow from the air vents.

- ▶ Make sure that all vehicle occupants always maintain a sufficient distance from the air vents.
- ▶ If necessary, direct the airflow to another area of the vehicle interior.

To guarantee the flow of fresh air through the air vents into the vehicle interior, comply with the following:

- Always keep the vents and vent grilles in the vehicle interior free.
- Keep the air inlet free of deposits (→ page 295).
- Optimum climate comfort is achieved with the air vents in the center position.



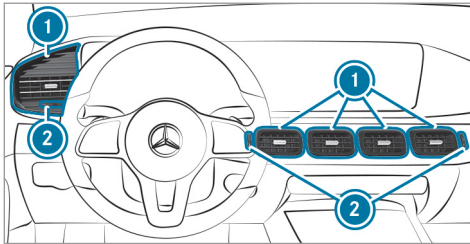

- ▶ **To open or close center air vents:** turn controller ② up or down as far as it will go.
- ▶ **To open or close side air vents:** turn controller ② to the left or right as far as it will go.
- ▶ **To adjust the air direction:** hold air vent ① in the center and move it up or down or to the left or right.

### Adjusting the rear air vents

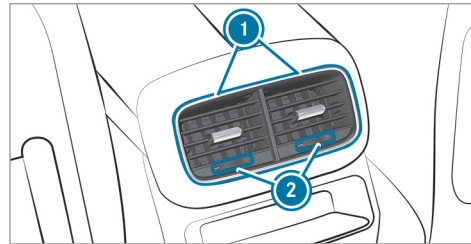

- ▶ **To open or close:** turn the controller ② to the left or right as far as it will go.
- ▶ **To set the airflow direction:** hold air vent ① in the center and move it up or down or to the left or right.

### Opening or closing the air vent in the glove box

**!** **NOTE** Damage to temperature-sensitive objects in the glove box

Temperature-sensitive objects stored in the glove box may be damaged by the air vent located inside it.

- ▶ Close the air vent when you heat the vehicle.
- ▶ At high outside temperatures, open the air vent and switch on the A/C function.

The automatic climate control must be switched on to cool the glove box.

## 142 Climate control

---

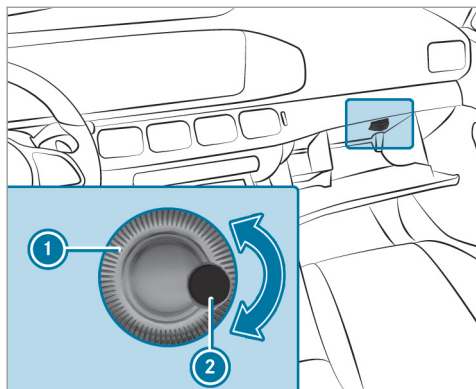

► **To open or close:** turn controller ① of air vent ② clockwise or counter-clockwise.

## Driving

### Notes on Mercedes-AMG vehicles

Observe the notes on the following additional topics in the Supplement, as you may otherwise fail to recognize dangers:

- Emotion Start
- AMG ACTIVE adaptive sport suspension system

### Switching on the power supply or the ignition (without engine start)

**⚠ WARNING** Risk of accident and injury due to children left unattended in the vehicle

If children are left unsupervised in the vehicle, they could, in particular:

- Open doors, thereby endangering other persons or road users.
- Get out and be struck by oncoming traffic.

- Operate vehicle equipment and become trapped, for example.

In addition, the children could also set the vehicle in motion, for example by:

- Releasing the parking brake.
  - Change the transmission position.
  - Start the vehicle.
- ▶ Never leave children unattended in the vehicle.
- ▶ When leaving the vehicle, always take the SmartKey with you and lock the vehicle.
- ▶ Keep the SmartKey out of reach of children.

Also observe the "Notes on pets in the vehicle".

#### Requirements:

- the SmartKey is located in the vehicle and the SmartKey battery is not discharged.
- the brake pedal is not depressed.

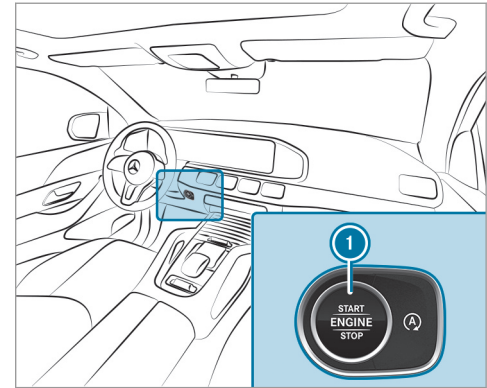

- ▶ **To switch on the power supply:** press button ① once. You can activate the windshield wipers, for example.

The power supply is switched off again if the following conditions are met:

- you open the driver's door.
- you press button ① twice more.

- ▶ **To switch on the ignition:** press button ① twice.  
The indicator lamps in the instrument cluster light up.

The ignition is switched off again if one of the following conditions is met:

- you do not start the vehicle within 15 minutes and the transmission is in position **P** or the electric parking brake is applied.
- you press button ① once.

### Starting the vehicle

#### Starting the vehicle with the start/stop button

**▲ DANGER** Risk of death caused by exhaust gases

Combustion engines emit poisonous exhaust gases such as carbon monoxide. Inhaling these exhaust gases is hazardous to health and leads to poisoning.

- ▶ Never leave the engine or, if present, the auxiliary heating running in an enclosed space without sufficient ventilation.

**▲ WARNING** Risk of fire due to flammable material in the engine compartment or the exhaust system

Flammable materials may ignite.

- ▶ Therefore, check regularly that there are no flammable materials in the engine compartment or on the exhaust system.

#### Requirements

- The SmartKey is located in the vehicle and the SmartKey battery is not discharged.
- ▶ Shift the transmission to position **P** or **N**.
- ▶ Depress the brake pedal and press button ① once.

- ▶ If the vehicle does not start: switch off non-essential consumers and press button ① once.

- ▶ If the vehicle still does not start and the [Place the Key in the Marked Space See Operator's Manual](#) message also appears in the multifunction display: start the vehicle with the SmartKey in the marked space (emergency operation mode) (→ page 144).

- ① You can switch off the engine while driving by pressing button ① for about three seconds or by pressing button ① three times within three seconds. Be sure to observe the safety notes under "Driving tips" (→ page 148).

#### Starting the vehicle with the SmartKey in the marked space (emergency operation mode)

If the vehicle does not start and the [Place the Key in the Marked Space See Operator's Manual](#) message appears in the multifunction display, you can start the vehicle in emergency operation mode.

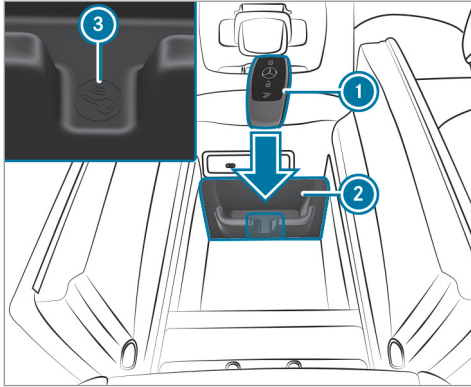

- ▶ Make sure that marked space ② is empty.
- ▶ Remove SmartKey ① from the key ring.
- ▶ Place SmartKey ① in marked space ② next to symbol ③.  
The vehicle will start after a short time.  
If you remove SmartKey ① from marked space ② the engine continues running. For further vehicle starts however, SmartKey ①

must be located in marked space ② next to symbol ③ during the entire journey.

- ▶ Have SmartKey ① checked at a qualified specialist workshop.

#### If the vehicle does not start:

- ▶ Place SmartKey ① in marked space ② and leave it there.
- ▶ Depress the brake pedal and start the vehicle using the start/stop button.
- ① You can also switch on the power supply or the ignition with the start/stop button.

#### Starting the vehicle via Remote Online services

##### Cooling or heating the vehicle interior before commencing your journey

Ensure the following before starting the engine:

- The legal stipulations in the area where your vehicle is parked allow engine starting via smartphone.
- It is safe to start and run the engine where your vehicle is parked.

- The fuel tank is sufficiently full.
- The starter battery is sufficiently charged.

#### Charging the starter battery before starting the journey

If the vehicle battery is discharged, you receive a message on your smartphone. You can then start the vehicle with the smartphone to charge the battery. The vehicle is automatically switched off after ten minutes.

Ensure the following before starting the engine:

- The legal stipulations in the area where your vehicle is parked allow engine starting via smartphone.
- It is safe to start and run the engine where your vehicle is parked.
- The fuel tank is sufficiently full.

### Starting the vehicle (Remote Online)

**⚠ WARNING** Risk of crushing or entrapment due to unintentional starting of the engine

Limbs could be crushed or trapped if the engine is started unintentionally during service or maintenance work.

- ▶ Always secure the engine against unintentional starting before carrying out maintenance or repair work.

#### Requirements:

- Park position **P** is selected.
- The anti-theft alarm system is not activated.
- The panic alarm is not activated.
- The hazard warning light system is switched off.
- The hood is closed.
- The doors are closed and locked.
- The windows and sliding sunroof are closed.

- ▶ Start the vehicle using the smartphone. After every engine start, the engine runs for ten minutes.

You can carry out a maximum of two consecutive starting attempts. The vehicle must be started once with the SmartKey before trying to start the engine again with the smartphone. you can stop the vehicle again at any time.

- ❗ Further information can be found in the smartphone app.

#### Securing the engine against starting before carrying out maintenance or repair work:

- ▶ Switch on the hazard warning light system.  
or
- ▶ Unlock the doors.  
or
- ▶ Open a side window or the sliding sunroof.

#### Breaking-in notes

**Mercedes-AMG vehicles:** observe the notes in the Supplement. You could otherwise fail to recognize dangers.

To preserve the engine during the first 1,000 miles (1,500 km):

- drive at varying road speeds and engine speeds.
- drive the vehicle in drive program **C** or **E**.
- shift to the next highest gear at the very latest when the needle reaches the last third before the red area in the tachometer.
- do not shift down a gear manually in order to brake.
- avoid overstraining the vehicle, e.g. driving at full throttle.
- do not depress the accelerator pedal past the pressure point (kickdown).
- only increase the engine speed gradually and accelerate the vehicle to full speed after 1,000 miles (1,500 km).

This also applies when the engine or parts of the drivetrain have been replaced.

Please also observe the following breaking-in notes:

- in certain driving and driving safety systems, the sensors adjust automatically while a certain distance is being driven after the vehicle has been delivered or after repairs. Full system effectiveness is not reached until the end of this teach-in process.
- brakepads, brake discs and tires that are either new or have been replaced only achieve optimum braking effect and grip after several hundred miles of driving. Compensate for the reduced braking effect by applying greater force to the brake pedal.

### Notes on optimized acceleration

If all necessary requirements and activation conditions are fulfilled, the best possible acceleration can be achieved from a standstill.

Do not use the optimized acceleration on public roads. Individual wheels could spin and you could lose control of the vehicle. There is an increased risk of skidding and/or accident.

Be sure to observe the safety notes and information on ESP® (→ page 176).

### Pulling away with optimized acceleration

**⚠ WARNING** Risk of skidding and having an accident from wheels spinning

When you use optimized acceleration, individual wheels could spin and you could lose control of the vehicle.

If ESP® is deactivated, there is a risk of skidding and accident.

- ▶ Make sure that no persons or obstacles are in the close vicinity of your vehicle.

### Requirements:

- The vehicle has been broken in (→ page 146).
- The vehicle and tires are in good condition.
- You are on a high-grip roadway.
- The engine and transmission are at normal operating temperature.

**!** **NOTE** Increased wear due to optimized acceleration

When pulling away with optimized acceleration, all components of the drivetrain are subjected to a very high load.

This can lead to increased component wear.

- ▶ Do not always pull away with optimized acceleration.

- ▶ Engage the **D** drive position (→ page 162).
- ▶ Move the steering wheel to the straight-ahead position.
- ▶ Select the sportiest available drive program **S!** or **S** (→ page 158).
- ▶ Deactivate ESP® (→ page 178).
- ▶ Depress and hold the brake pedal firmly with your left foot.
- ▶ With your right foot, fully depress the accelerator pedal.

- ▶ After no more than five seconds, take your left foot quickly off the brake, but keep the accelerator pedal depressed. The vehicle pulls away at maximum acceleration.
- ▶ Switch on ESP® once the acceleration procedure is complete.

#### Ending optimized acceleration

- ▶ Remove your foot from the accelerator pedal.
- ▶ Reactivate the ESP®.
- ⓘ After you pull away with optimized acceleration, components of the drivetrain can become very hot, which means that optimized acceleration values may be reached again only after a few minutes.

#### Notes on driving

**⚠ WARNING** Risk of accident due to objects in the driver's footwell

Objects in the driver's footwell may impede pedal travel or block a depressed pedal.

This jeopardizes the operating and road safety of the vehicle.

- ▶ Stow all objects in the vehicle securely so that they cannot get into the driver's footwell.
- ▶ Always install the floor mats securely and as prescribed in order to ensure that there is always sufficient room for the pedals.
- ▶ Do not use loose floor mats and do not place floor mats on top of one another.

**⚠ WARNING** Risk of accident due to incorrect footwear

Incorrect footwear includes, for example:

- Shoes with platform soles
- Shoes with high heels
- Slippers
- ▶ Always wear suitable footwear so that you can operate the pedals safely.

**⚠ WARNING** Risk of accident when switching off the ignition when driving

If you switch off the ignition while driving, safety functions are restricted or no longer available.

You will then need, for example, to use considerably more force to steer and brake.

- ▶ Do not switch off the ignition while driving.

**⚠ DANGER** Risk of death caused by exhaust gases

Combustion engines emit poisonous exhaust gases such as carbon monoxide. Inhaling these exhaust gases is hazardous to health and leads to poisoning.

- ▶ Never leave the engine or, if present, the auxiliary heating running in an enclosed space without sufficient ventilation.



**▲ WARNING** Risk of skidding and of an accident due to shifting down on slippery road surfaces

If you shift down on slippery road surfaces to increase the engine braking effect, the drive wheels may lose traction.

- ▶ Do not shift down on slippery road surfaces to increase the engine braking effect.

**▲ DANGER** Risk of fatal injury due to poisonous exhaust gases

If the tailpipe is blocked or sufficient ventilation is not possible, poisonous exhaust gases such as carbon monoxide may enter the vehicle. This is the case when the vehicle becomes stuck in snow, for example.

- ▶ Keep the tailpipe and the area around the vehicle free from snow when the engine or the stationary heater are running.

- ▶ Open a window on the side of the vehicle facing away from the wind to ensure an adequate supply of fresh air.

**▲ WARNING** Risk of accident and injury due to being under the influence of alcohol and drugs while driving

Driving when under the influence of alcohol and/or drugs is an extremely dangerous combination. Even small quantities of alcohol or drugs may affect your reflexes, perception and judgment.

The probability of a serious or even fatal accident greatly increases if you drive when under the influence of alcohol or drugs.

- ▶ Do not drink alcohol or take drugs while driving, and do not allow anyone to drive who has been drinking alcohol or taking drugs.

**▲ WARNING** Risk of accident due to the brake system overheating

If you leave your foot on the brake pedal when driving, the brake system may overheat.

This increases the braking distance and the brake system may even fail.

- ▶ Never use the brake pedal as a footrest.
- ▶ Do not depress the brake pedal and the accelerator pedal at the same time while driving.

**! NOTE** Engine damage due to excessively high engine speeds

The engine will be damaged if you drive with the engine in the overrevving range.

- ▶ Do not drive with the engine in the overrevving range.

**!** **NOTE** Wearing out the brake linings by continuously depressing the brake pedal

- ▶ Do not depress the brake pedal continuously whilst driving.
- ▶ To use the braking effect of the engine, shift to a lower gear in good time.

**!** **NOTE** Damage to the drivetrain and engine when pulling away

- ▶ Do not warm up the engine while the vehicle is stationary. Pull away immediately.
- ▶ Avoid high engine speeds and driving at full throttle until the engine has reached its operating temperature.

**!** **NOTE** Damage to the catalytic converter due to non-combusted fuel

The engine is not running smoothly and is misfiring.  
Non-combusted fuel may get into the catalytic converter.

▶ Only depress the accelerator pedal slightly.

▶ Have the cause rectified immediately at a qualified specialist workshop.

#### **Notes on driving on salt-treated roads**

The braking effect is limited on salt-treated roads.

Therefore, observe the following notes:

- due to salt build-up on the brake discs and brakepads, the braking distance can increase considerably or result in braking only on one side
- maintain a much greater safe distance to the vehicle in front

To remove salt build-up:

- brake occasionally while paying attention to the traffic conditions
- carefully depress the brake pedal at the end of the journey and when starting the next journey

#### **Notes on hydroplaning**

Hydroplaning can take place once a certain amount of water has accumulated on the road surface.

Observe the following notes during heavy precipitation or in conditions in which hydroplaning may occur:

- reduce speed
- avoid tire ruts
- avoid sudden steering movements
- brake carefully

**i** Also observe the notes on regularly checking wheels and tires (→ page 320).

#### **Notes on driving through water on the road surface**

Water which has entered into the vehicle can damage the engine, electrics and transmission. Water can also enter the air intake of the engine and cause engine damage.

Observe the following if you must drive through water:

- Observe the maximum permissible fording depth (→ page 365).
- Drive at walking pace at most, otherwise water can enter the vehicle interior or engine compartment.
- Vehicles traveling in front, or oncoming vehicles, can create waves which may exceed the maximum permissible depth of the water.

The braking effect of the brakes is reduced after fording. Brake carefully while paying attention to the traffic conditions until braking power has been fully restored.

### Notes on off-road driving

**⚠ WARNING** Risk of accident if you do not keep to line of fall on inclines

If you drive at an angle or turn on an incline, the vehicle could slip sideways, tip and roll-over.

- ▶ Always drive on inclines in the line of fall (straight up or down) and do not turn.

**⚠ WARNING** Risk of fire due to flammable materials on hot parts of the exhaust system

Flammable material such as leaves, grass or twigs may ignite if they come into contact with hot parts of the exhaust system.

- ▶ When driving on unpaved roads or off-road, regularly check the vehicle underside.
- ▶ Remove trapped plants or other flammable material, in particular.
- ▶ If there is damage, consult a qualified specialist workshop immediately.

When driving off-road, sand, mud and water or water mixed with oil may get into the brakes. This may lead to a reduction in braking effect or total brake failure as a result of increased wear. The braking characteristics will vary depending on the material that has entered the system.

Clean the brakes after driving off-road. If you then notice reduced braking effect or hear scraping noises, have the brake system checked at a qualified specialist workshop. Adapt your driving style to the changed braking characteristics.

**! NOTE** Damage caused by driving over obstacles

The vehicle can be damaged by:

- driving up onto high curbs or unpaved roads.
  - quickly driving over obstacles such as curbs, speed bumps or potholes.
  - heavy objects hitting the underbody or chassis components.
- ▶ Do not drive over obstacles that could damage the vehicle.
  - ▶ Check the vehicle regularly for damage during off-road driving.
  - ▶ Adjust the vehicle speed to suit the road surface conditions.

- ▶ If there is damage, consult a qualified specialist workshop immediately.

 **ENVIRONMENTAL NOTE** Environmental damage due to non-observance of prohibition signs

Environmental protection has priority. Treat nature with respect.

- ▶ Be sure to observe prohibition signs.

### Checklist before driving off-road

Check the following points before driving off-road:

- Fuel level
- Engine oil level: fill engine oil to the maximum level to ensure full gradeability (→ page 291).
- Tire-change tool kit and spare wheel
- Tires and wheels
- ① Further information about special all-terrain tires for retrofitting can be obtained from a qualified specialist workshop.

### Off-road driving

Read this section before driving your vehicle off-road. Practice by driving over more gentle off-road terrain first.

- Observe the notes on the cross-country ABS (→ page 176).
- If necessary, select the  (→ page 158) drive program before driving off-road.
- Select a vehicle level suitable for off-road terrain (→ page 203). To avoid damaging the vehicle, make sure there is always sufficient ground clearance.
- Always keep the engine running and in gear when driving on downhill gradients and slopes. Observe the notes on driving in mountainous terrain.
- Do not drive on unknown terrain that is not easily visible and stay on marked routes.
- Always keep the doors and windows closed while the vehicle is in motion.
- Deactivate Active Distance Assist DISTRONIC and cruise control.
- Adapt your driving style to the terrain.

- Do not use the HOLD function on steep downhill or uphill gradients with slippery or loose surfaces.

### Driving on sand

When driving on sand, also observe the following instructions:

- Select the  drive program.
- Select a higher vehicle level.
- Shift to a lower gear.
- Drive quickly to overcome the rolling resistance, otherwise the vehicle may dig itself in.
- Drive in the tracks of other vehicles if possible. Make sure that the following prerequisites are met:
  - the tire ruts are not too deep
  - the sand is firm enough
  - the ground clearance is sufficient

**Mercedes-AMG vehicles:** observe the notes in the Supplement. You could otherwise fail to recognize dangers.

### Fording

Also observe the following information when fording:

- Drive no faster than 6 mph (10 km/h).
- Observe the maximum permissible fording depth (→ page 365).
- Switch off automatic climate control (→ page 137).
- Ensure that a bow wave does not form as you drive.
- Do not stop in the water and do not switch off the engine. Ensure the ECO start/stop function is switched off (→ page 155).

### Driving in mountainous terrain

Also observe the following information when driving in mountainous terrain:

- Observe the values of the approach/departure angle and of the maximum gradient (→ page 365).
- Avoid high engine speeds.
- Use the braking power of the engine when driving downhill.

- Shift to a lower gear on uphill gradients and on long, steep downhill gradients.
- Activate DSR before driving downhill, if necessary (→ page 186).

### Checklist after driving off-road

Driving off-road places greater demands on your vehicle than driving on normal roads. Check the entire vehicle for damage and foreign bodies every time after driving off-road. Foreign bodies in the wheels or drivetrain can lead to imbalances and therefore vibrations.





- If the  drive program is selected: select another drive program.
- Deactivate DSR.
- Lower the vehicle level again to a level suitable to the road conditions, e.g. to the normal level.
- Apply the brakes to dry them after fording.
- Check that the service brake is working normally after a long downhill stretch.
- Clean the following components every time after driving off-road:
  - license plate number

- headlamps and tail lamps
- tires, wheels and wheel arches
- underbody
- After driving through sand, mud, water or gravel, have the following components checked and cleaned:
  - brake discs and brakepads
  - tires and wheels
  - axle joints

### ECO start/stop function

#### Operation of the ECO start/stop function

**Mercedes-AMG vehicles:** observe the notes in the Supplement. You could otherwise fail to recognize dangers.

- ① The ECO start/stop function is available only in the , , ,  and  drive programs (depending on the setting).

## 154 Driving and parking

The engine is switched off automatically in the following situations if all vehicle conditions for an automatic engine stop are met:

- you brake the vehicle to a standstill in transmission position **D** or **N**.
- **vehicles with a 48 V on-board electrical system:** you depress the brake pedal when traveling at a low speed.

If the system has detected one of the following situations, the engine will not stop:





- you stop at a stop sign and there is no vehicle in front of you.
  - the vehicle that stopped in front of you starts up again.
  - you maneuver, turn the steering wheel sharply or engage reverse gear.
- i** When the HOLD function is active and in transmission position **P**, the engine can stop in spite of an intelligent stop inhibitor.

The engine is restarted automatically if:

- you engage transmission position **D** or **R**.
- you depress the accelerator pedal.

- an automatic engine start is required by the vehicle.
- you release the brake pedal.
- **vehicles with a 48 V on-board electrical system:**
  - you release the brake pedal on a downhill gradient and the vehicle does not roll.
  - the vehicle rolls on a downhill gradient and does not automatically enter glide mode at 15 mph (20 km/h).

ECO start/stop function symbols in the multifunction display:

- the  symbol (green) appears when the vehicle is at a standstill: the engine was switched off by the ECO start/stop function.
- the  symbol (yellow) appears when the vehicle is at a standstill: not all vehicle conditions for an engine stop have been met.
- neither the  nor  symbol appears when the vehicle is at a standstill: an intelligent stop inhibitor was detected, e.g. a stop sign.

- the  symbol appears: the ECO start/stop function is deactivated or there is a malfunction.

If the engine was switched off by the ECO start/stop function and you leave the vehicle, a warning tone sounds and the engine is not restarted. In addition, the following display message appears in the multifunction display:

**Vehicle Ready to Drive Switch the Ignition Off Before Exiting**

If you do not switch off the ignition, the ignition is automatically switched off after three minutes.

## Deactivating or activating the ECO start/stop function

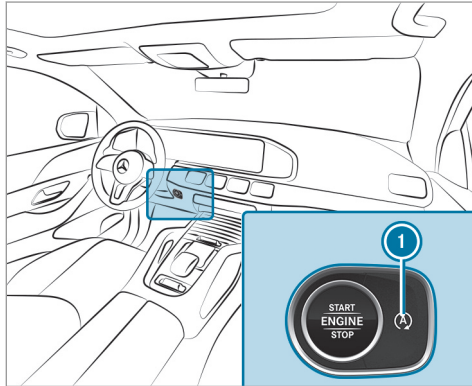

- ▶ Press button ①.  
A display appears in the instrument cluster when switching the ECO start/stop function off/on.
- ⓘ A continuous  display appears in the instrument cluster while the ECO start/stop function is deactivated.

## ECO display function

The ECO display summarizes your driving characteristics from the start of the journey to its completion and assists you in achieving the most economical driving style.

You can influence consumption by doing the following:

- Drive with particular care
- Driving the vehicle in drive program 
- Follow the gearshift recommendations

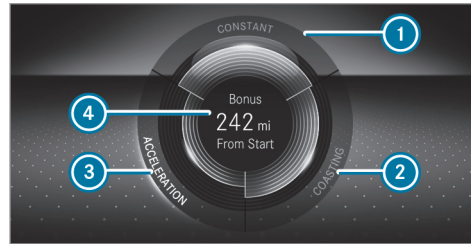

The lettering in the segment will light up brightly, the outer edge will light up and the segment will fill up when the following driving style is adopted:

- ① Steady speed
- ② Gentle deceleration and rolling
- ③ Moderate acceleration

The lettering in the segment will be gray, the outer edge will be dark and the segment will empty when the following driving style is adopted:

- ① Fluctuations in speed
- ② Heavy braking
- ③ Sporty acceleration

The ECO display will show you when you have driven economically:

- The three segments will fill up completely at the same time
- The edges around all three segments will light up

The additional range achieved as a result of your driving style in comparison with a driver with a very sporty driving style will be shown in the center of display ④. The range displayed does not indicate a fixed reduction in consumption.

### ECO Assist function

#### Vehicles with a 48 V on-board electrical system (EQ Boost technology):

ECO Assist analyzes data for the vehicle's expected route. This allows the system to optimally adjust the driving style for the route ahead, save fuel and recuperate. If the system detects an event ahead, e.g. a speed limit or a roundabout, it will appear on the multifunction display. The following symbols can be displayed:

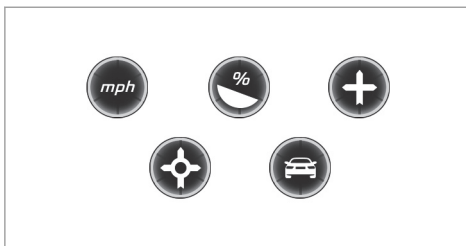

Examples of an event ahead

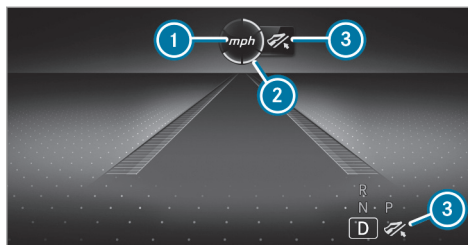

- ① Event ahead
- ② Distance display for the event ahead
- ③ "Foot off the accelerator" prompt

Distance display segments ② show the distance to the event ahead as follows:

- A few segments light up: the event ahead is near.
- Many segments light up: the event ahead is further away.

When the vehicle nears the event, ECO Assist will calculate the optimal speed for maximum fuel economy and recuperative energy based on the distance, speed and downhill gradient. The **Foot off the Accelerator** ③ message appears in the multifunction display. The first segments in front of the vehicle will turn green. The remaining segments will initially stay white. If the driver takes their foot off the accelerator pedal in good time, the remaining segments on the display will successively turn green until the event shown is reached. The drivetrain will be set for maximum fuel economy. Recuperation will charge the battery. Recuperation will be adapted to the selected drive program.

The event will be shown for a short time after it has been passed. If there is no response to the



**Foot off the Accelerator** prompt, the segments will remain white.

If the event involves a vehicle in front, all segments will immediately turn green once there is a response to the **Foot off the Accelerator** prompt.

For active ECO Assist in drive program **[E]**, symbol **③** will appear on the multifunction display and on the Head-up Display beside transmission position **[D]**. Symbol **③** will also appear when the assistant display is not selected.

If the system does not intervene during the event ahead, nothing will be displayed. The system is passive.

ECO Assist is active only in drive programs **[E]** and **[C]**.

### System limits

ECO Assist can function even more precisely if the route is adhered to when route guidance is active. The basic function is also available without active route guidance. Not all information and traffic situations can be foreseen. The quality depends on the map data.

ECO Assist is only an aid. The driver is responsible for keeping a safe distance from the vehicle in front, for vehicle speed and for braking in good time. The driver must be ready to brake at all times irrespective of whether the system intervenes.

The system may be impaired or may not function in the following situations:

- If there is poor visibility, e.g. due to insufficient illumination of the road, highly variable shade conditions, rain, snow, fog or heavy spray.
- If there is glare, e.g. from oncoming traffic, direct sunlight or reflections.
- If there is dirt on the windshield in the area of the multifunction camera or the camera is fogged up, damaged or obscured.
- If traffic signs are hard to discern, e.g. due to dirt, snow or insufficient lighting, or because they are obscured.
- If the information on the navigation system's digital map is incorrect or out of date.
- If signs are ambiguous, e.g. traffic signs in roadworks or in adjacent lanes.

## DYNAMIC SELECT switch

### Function of the DYNAMIC SELECT switch

**Mercedes-AMG vehicles:** observe the notes in the Supplement. You could otherwise fail to recognize dangers.

- ① Depending on the engine and equipment, the vehicle has different drive programs.

Use the DYNAMIC SELECT switch to change between the following drive programs:

- [I]** **(Individual):** individual settings
- [S+]** **(Sport +):** particularly sporty driving style
- [S]** **(Sport):** sporty driving style
- [C]** **(Comfort):** comfortable and economical driving style
- [E]** **(Eco):** particularly economical driving style
- [CV]** **(CURVE):** comfortable driving with curve inclination function (vehicles with E-ACTIVE BODY CONTROL)
-  **Offroad:** driving on less demanding off-road terrain

- ① The drive program selected appears in the multifunction display of the on-board computer.
- ① Depending on the situation, the cylinder can be briefly deactivated in the drive programs **E** and **C**, depending on the engine.

Depending on the drive program, the following systems change their characteristics:

- Drive
  - Engine and transmission management
  - Active Distance Assist DISTRONIC
- ESP®
- **Vehicles with AIRMATIC or E-ACTIVE BODY CONTROL:**
  - Suspension tuning
  - Vehicle level
- Electric power steering

### Notes on the roof load display

Certain drive programs and ESP® settings are unsuitable for transporting a roof load.

If one of these drive programs is set or selected,



the symbol is shown as a warning. When this symbol is shown, the selected drive program is not suitable for transporting a load on the roof.

The following drive programs are affected:

- **Sport** drive program
- **Sport +** drive program
- **Individual** drive program with the ESP® set-ting Sport or Sport+

① The symbol is also shown in the following situations:

- Within the themes if a corresponding drive program is saved

For more information on themes see .

- Within the reset display if the previously active drive program is unsuitable for the transport of a roof load

For further information on the reset display, see (→ page 159).

### Selecting the drive program

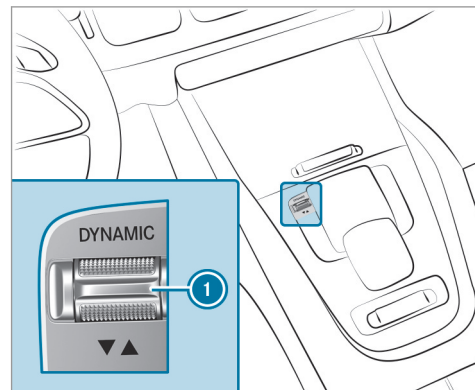

- ▶ Press DYNAMIC SELECT switch  forwards or backwards.  
The drive program selected appears in the multifunction display.

### Configuring DYNAMIC SELECT (multimedia system)

Multimedia system:

-  » Settings » Vehicle
- ▶ DYNAMIC SELECT

#### Setting drive program I

- ▶ Select **Individual Configuration**.
- ▶ Select and set a category.

#### Switching the restoration display on or off

- ▶ Switch **Request at Start** on or off.

**Function on:** the next time the vehicle is started a prompt appears asking whether the last active drive program should be restored. If the ECO start/stop function was deactivated, an additional prompt appears asking if the function should remain deactivated.

-  The prompt appears only if the previously active settings deviate from the standard settings.

**Function off:** the next time the vehicle is started the  drive program is set automatically. The ECO start/stop function is activated automatically.

-  This function must be activated for each user profile separately. Only when this function is activated will the drive program and Eco start/stop setting for the previous journey be saved for the respective user profile.



### Displaying vehicle data

Multimedia system:

-  » Info
- ▶ Select **Vehicle**.  
The vehicle data is displayed.

### Displaying engine data

Multimedia system:

-  » Info
- ▶ Select **Engine**.  
The engine data is displayed.
-  The actual (maximum) values that can be achieved for engine output and engine torque may deviate from the certified values within the country-specific guidelines for permissible tolerances (basis: UN-ECE No. 85 or country-specific guidelines).  
Factors that can influence this are, for example:
  - Sea level
  - Fuel grade
  - Outside temperature
  - Operating temperature of the engine
-  The values displayed serve only as orientation. The values for engine output and engine torque shown in the media display may deviate from the actual values.

## Calling up the consumption indicator

Multimedia system:



▶ Select **Consumption**.

The current and average consumption is displayed.

## Automatic transmission

### DIRECT SELECT lever

#### Function of the DIRECT SELECT lever

**▲ WARNING** Risk of accident due to incorrect gearshifting

If the engine speed is higher than the idle speed and you engage the transmission position **D** or **R**, the vehicle may accelerate sharply.

▶ If you engage the transmission position **D** or **R** when the vehicle is at a standstill, always depress the brake pedal firmly and do not accelerate at the same time.

**▲ WARNING** Risk of accident and injury due to children left unattended in the vehicle

If children are left unsupervised in the vehicle, they could, in particular:

- Open doors, thereby endangering other persons or road users.
- Get out and be struck by oncoming traffic.
- Operate vehicle equipment and become trapped, for example.

In addition, the children could also set the vehicle in motion, for example by:

- Releasing the parking brake.
- Change the transmission position.
- Start the vehicle.

▶ Never leave children unattended in the vehicle.

▶ When leaving the vehicle, always take the SmartKey with you and lock the vehicle.

▶ Keep the SmartKey out of reach of children.

Use the DIRECT SELECT lever to switch the transmission position. The current transmission position is displayed in the multifunction display.

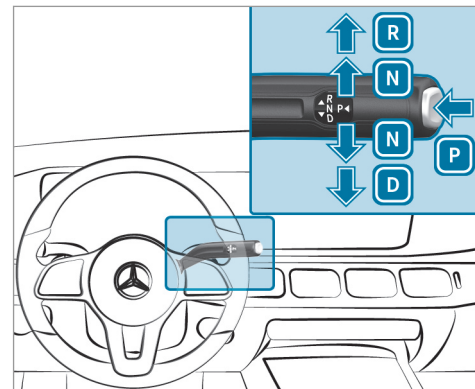

**P** Park position

**R** Reverse gear

**N** Neutral

**D** Drive position

### Engaging reverse gear R

- ▶ Depress the brake pedal and push the DIRECT SELECT lever upwards past the first point of resistance.

### Engaging neutral N

- ▶ Depress the brake pedal and push the DIRECT SELECT lever up or down to the first point of resistance.

Subsequently releasing the brake pedal will allow you to move the vehicle freely, e.g. to push it or tow it away.

**Proceed as follows if you want the automatic transmission to remain in neutral **N** even if the ignition is switched off or the driver's door is opened:**

- ▶ Start the vehicle.

- ▶ Depress the brake pedal and engage neutral **N** when the car is stationary. The **N Permanently Active Risk of Rolling Away** message appears in the instrument cluster.

- ▶ Release the brake pedal.

- ▶ Switch the ignition off.

- ⓘ If you then exit the vehicle leaving the SmartKey in the vehicle, the automatic transmission remains in neutral **N**.

The park position **P** is automatically re-engaged as soon as one of the following conditions is met:

- You switch to transmission position **D** or **R**.
- You press the **P** button.

### Engaging park position P

- ▶ Observe the notes on parking the vehicle (→ page 167).
- ▶ Depress the brake pedal until the vehicle is stationary.

- ▶ When the vehicle is stationary, press button **P**.

When the transmission position display shows **P**, the park position is engaged. If no transmission position display **P** appears, secure the vehicle to prevent it from rolling away.

- ⓘ Depending on the situation, it may take a short time until **P** is engaged. Therefore, always pay attention to the transmission position display.

Park position **P** is engaged automatically if one of the following conditions is met:

- you switch off the ignition when the vehicle is stationary and the transmission is in position **D** or **R**.
- you open the driver's door when the vehicle is stationary or when driving at a very low speed and the transmission is in position **D** or **R**.
- you switch the engine off and bring the vehicle to a standstill when the vehicle is rolling and the transmission is in position **D** or **R**.

- you switch off the engine, bring the vehicle to a standstill and open the driver's door when the vehicle is stationary or when the vehicle is rolling and the transmission is in position **N**.
  - engaging park position **P** automatically is required by the vehicle.
- i** To maneuver with an open driver's door, open the driver's door while stationary and engage transmission position **D** or **R** again.

### Engaging drive position **D**

- ▶ Depress the brake pedal and push the **DIRECT SELECT** lever down past the first point of resistance.

When the automatic transmission is in transmission position **D**, it shifts the gears automatically. This depends, among other things, on the following factors:

- The selected drive program
- The position of the accelerator pedal
- The driving speed

### Manual gearshifting

#### Permanent setting (vehicles with E-Active Body Control)

**Mercedes-AMG vehicles:** observe the notes in the Supplement. You could otherwise fail to recognize dangers.

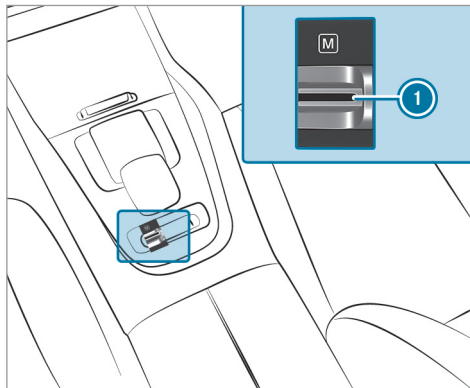

- ▶ **To activate/deactivate:** pull rocker switch **1**.

If indicator lamp is lit, manual gearshifting is activated. The current gear is displayed in the multifunction display.

#### Temporary setting

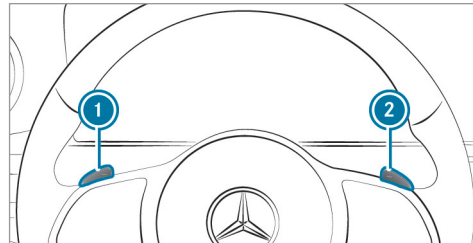

- ▶ **To activate:** pull steering wheel gearshift paddle **1** or **2**. Manual gearshifting is activated for a short time. Transmission position **M** and the current gear appear in the multifunction display.

▶ **To deactivate:** pull steering wheel gearshift paddle ② and hold it in place. The transmission position **D** appears in the multifunction display.

① To permanently shift the gears manually in drive program **I+** using the steering wheel gearshift paddles, select the **M** setting for the transmission.

### Gearshifting

▶ **To shift up:** pull steering wheel gearshift paddle ②.

▶ **To shift down:** pull steering wheel gearshift paddle ①.

### Gearshift recommendation

**Mercedes-AMG vehicles:** observe the notes in the Supplement. You could otherwise fail to recognize dangers.

The gearshift recommendation assists you in adopting an economical driving style.

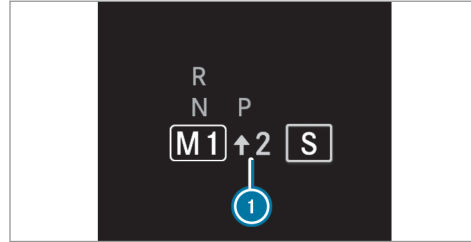

▶ If gearshift recommendation ① appears next to the transmission position display, shift to the recommended gear.

### Using kickdown

**Mercedes-AMG vehicles:** observe the notes in the Supplement. You could otherwise fail to recognize dangers.

▶ **Maximum acceleration:** depress the accelerator pedal beyond the pressure point.

The automatic transmission shifts up to the next gear when the maximum engine speed is reached to protect the engine from overrevving.

### Glide mode function

**Mercedes-AMG vehicles:** observe the notes in the Supplement. You could otherwise fail to recognize dangers.

With an anticipatory driving style, Glide mode helps you to reduce fuel consumption.

Glide mode is characterized by the following:

- The combustion engine is disconnected from the drivetrain and continues to run in neutral.
- The transmission position display **D** is shown in green.
- **Vehicles with 48 V on-board electrical system (EQ-Boost technology):** the combustion engine can be switched off. All of the vehicle functions remain active.

Glide mode is activated if the following conditions are met:

- Drive program **E** is selected.
- The speed is within a suitable range.
- The road's course is suitable, e.g. no steep uphill or downhill inclines or tight curves.

- There is no trailer coupled to the trailer hitch, and no bicycle rack installed.
- You do not depress the accelerator or brake pedal (except for light brake applications).
- ① Glide mode can also be activated if you have selected the "Eco" setting for the drive in the drive program .

Glide mode is deactivated again if one of the conditions is no longer met.

Glide mode can also be prevented by the following parameters:

- Incline
- Downhill gradient
- Temperature
- Height
- Speed
- Operating status of the engine
- Traffic situation

### Function of the 4MATIC

4MATIC ensures that all four wheels are driven. Together with ESP® and 4ETS, 4MATIC improves the traction of your vehicle whenever a driven wheel spins due to insufficient traction.

If you fail to adapt your driving style, 4MATIC can neither reduce the risk of an accident nor override the laws of physics. 4MATIC cannot take account of road, weather and traffic conditions. 4MATIC is only an aid. You are responsible especially for maintaining a safe distance from the vehicle in front, for vehicle speed, for braking in good time and for staying in lane.

- ① In wintry road conditions, the maximum effect of 4MATIC can be achieved only if you use winter tires (M+S tires), with snow chains if necessary.

### Refueling

#### Refueling the vehicle

**⚠ WARNING** Risk of fire or explosion from fuel

Fuels are highly flammable.

- ▶ Fire, open flames, smoking and creation of sparks must be avoided.
- ▶ Switch off the ignition and, if available, the stationary heater, before and while refueling the vehicle.

**⚠ WARNING** Risk of injury from fuels

Fuels are poisonous and hazardous to your health.

- ▶ Do not swallow fuel or let it come into contact with skin, eyes or clothing.
- ▶ Do not inhale fuel vapor.
- ▶ Keep children away from fuel.
- ▶ Keep doors and windows closed during the refueling process.



If you or other people come into contact with fuel, observe the following:

- ▶ Immediately rinse fuel off your skin with soap and water.
- ▶ If fuel comes into contact with your eyes, immediately rinse them thoroughly with clean water. Seek medical attention immediately.
- ▶ If you swallow fuel, seek medical attention immediately. Do not induce vomiting.
- ▶ Change immediately out of clothing that has come into contact with fuel.

**⚠ WARNING** Risk of fire and explosion due to electrostatic charge

Electrostatic charge can ignite fuel vapor.

- ▶ Before you open the fuel filler cap or take hold of the pump nozzle, touch the metallic vehicle body.

- ▶ To avoid creating another electrostatic charge, do not get into the vehicle again during the refueling process.

**!** **NOTE** Damage caused by the wrong fuel

Vehicles with a gasoline engine:

Even small amounts of the wrong fuel could result in damage to the fuel system, the engine and the emission control system.

- ▶ Only refuel with low-sulfur unleaded fuel.

This fuel may contain up to 10% ethanol. Your vehicle is suitable for use with E10 fuel.

Never refuel with one of the following fuels:

- Diesel
- Gasoline with more than 10% ethanol by volume, e.g. E15, E85, E100
- Gasoline with more than 3% methanol by volume, e.g. M15, M30, M85, M100
- Gasoline with additives containing metal

If you have accidentally refueled with the wrong fuel:

- ▶ Do not switch the ignition on.
- ▶ Consult a qualified specialist workshop.

**!** **NOTE** Do not use diesel to refuel vehicles with a gasoline engine

If you have accidentally refueled with the wrong fuel:

- Do not switch the ignition on. Otherwise fuel can enter the engine. Even small amounts of the wrong fuel could result in damage to the fuel system and the engine. The repair costs are high.
- ▶ Consult a qualified specialist workshop.
- ▶ Have the fuel tank and fuel lines drained completely.

**!** **NOTE** Damage to the fuel system caused by overfilled fuel tanks

- ▶ Only fill the fuel tank until the pump nozzle switches off.

If you have added too much fuel because of a defective filling pump, for instance:

- ▶ Do not switch the ignition on.
- ▶ Consult a qualified specialist workshop.

**!** **NOTE** Fuel may spray out when you remove the fuel pump nozzle

- ▶ Only fill the fuel tank until the pump nozzle switches off.

**Requirements:**

- The vehicle is unlocked.
- i** Do not get into the vehicle again during the refueling process. Otherwise, electrostatic charge could build up again.

Observe the notes on operating fluids and fuel.

Only refuel with fuel that has at least the octane number specified in the information label in the fuel filler flap. Otherwise, engine output can be reduced and fuel consumption increased.

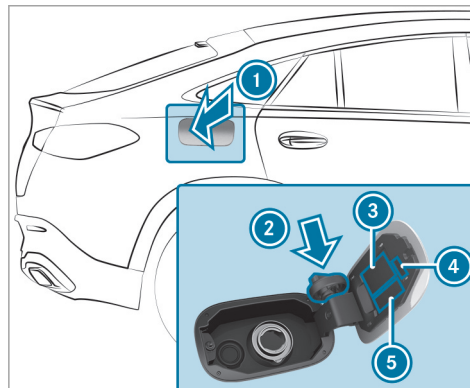

- 1** Fuel filler flap
- 2** Bracket for fuel filler cap
- 3** Tire pressure table
- 4** QR code for rescue card
- 5** Fuel type

- 4** QR code for rescue card
- 5** Fuel type

- ▶ Press on the back area of fuel filler flap **1**.
- ▶ Turn the fuel filler cap counter-clockwise and remove it.
- ▶ Insert the fuel filler cap from above into bracket **2**.
- ▶ Completely insert the pump nozzle into the tank filler neck, hook in place and refuel.
- ▶ Only fill the fuel tank until the pump nozzle switches off.
- ▶ Replace the cap on the filler neck and turn clockwise until it engages audibly.
- ▶ Close fuel filler flap **1**.
- i** Close the fuel filler flap before locking the vehicle.

## Parking

### Parking the vehicle

**⚠ WARNING** Risk of accident and injury caused by an insufficiently secured vehicle rolling away

If the vehicle is not securely parked sufficiently, it can roll away in an uncontrolled way even at a slight downhill gradient.

- ▶ On uphill or downhill gradients, turn the front wheels so that the vehicle rolls towards the curb if it starts moving.
- ▶ Apply the parking brake.
- ▶ Switch the transmission to position **P**.

**⚠ WARNING** Risk of fire caused by hot exhaust system parts

Flammable materials such as leaves, grass or twigs may ignite.

- ▶ Park the vehicle so that no flammable material can come into contact with hot vehicle components.

- ▶ In particular, do not park on dry grass-land or harvested grain fields.

**⚠ WARNING** Risk of accident and injury due to children left unattended in the vehicle

If children are left unsupervised in the vehicle, they could, in particular:

- Open doors, thereby endangering other persons or road users.
- Get out and be struck by oncoming traffic.
- Operate vehicle equipment and become trapped, for example.

In addition, the children could also set the vehicle in motion, for example by:

- Releasing the parking brake.
  - Change the transmission position.
  - Start the vehicle.
- ▶ Never leave children unattended in the vehicle.

- ▶ When leaving the vehicle, always take the SmartKey with you and lock the vehicle.
- ▶ Keep the SmartKey out of reach of children.

**! NOTE** Damage to the vehicle due to it rolling away

- ▶ Always secure the vehicle against rolling away.

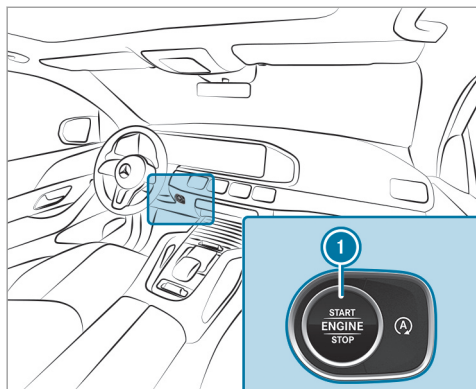

- ▶ Bring the vehicle to a standstill by applying the brake pedal.
- ▶ On gradients, turn the front wheels so that the vehicle will roll towards the curb if it starts moving.
- ▶ Apply the electric parking brake.

- ▶ Engage transmission position **P** in a stationary vehicle with the brake pedal applied (→ page 161).
  - ▶ Switch off the engine and the ignition by pressing button **1**.
  - ▶ Release the service brake slowly.
  - ▶ Get out of the vehicle and lock it.
- i** When you park the vehicle, you can still operate the side windows and the panorama roof with power tilt/sliding panel for approximately five minutes if the driver's door is closed.

### Garage door opener

#### Programming buttons for the garage door opener

**⚠ DANGER** Risk of death caused by exhaust gases

Combustion engines emit poisonous exhaust gases such as carbon monoxide. Inhaling these exhaust gases is hazardous to health and leads to poisoning.

- ▶ Never leave the engine or, if present, the auxiliary heating running in an enclosed space without sufficient ventilation.

**⚠ WARNING** Risk of injury when opening or closing a door with the garage door opener

When you operate or program the door with the integrated garage door opener, persons in the range of movement of the door may become trapped or be struck by the door.

- ▶ Always make sure that nobody is within the range of movement of the door.

Only operate the following doors using the garage door opener:

- Doors with a safety stop and reversing feature
- Doors which conform to the current U.S. safety standards

#### Requirements:

- The vehicle has been parked outside the garage or outside the range of movement of the door.
  - The engine is switched off.
  - The ignition is switched on.
- i** The garage door opener function is always available when the ignition is switched on.

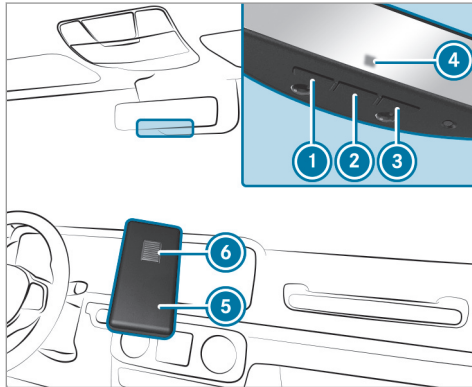

- ▶ Check if the transmitter frequency of the remote control has the frequency range of 280 to 868 MHz.  
Radio equipment approval number:
  - NZLMUAHL5 (USA)
  - 4112A-MUAHL5 (Canada)
- ▶ Press and hold button **1**, **2** or **3** that you wish to program.  
Indicator lamp **4** flashes yellow.
- i** It can take up to 20 seconds before the indicator lamp flashes yellow.
- ▶ Release the previously pressed button.  
Indicator lamp **4** continues to flash yellow.
- ▶ Point remote control **5** from a distance of 0.4 in (1 cm) to 3 in (8 cm) towards button **1**, **2** or **3**.
- ▶ Press and hold button **6** of remote control **5** until one of the following signals appears:
  - Indicator lamp **4** lights up green continuously. Programming is complete.
  - Indicator lamp **4** flashes green. Programming was successful. Additionally,

synchronization of the rolling code with the door system must also be carried out.

- ▶ If indicator lamp **4** does not light up or flash green: repeat the procedure.
- ▶ Release all of the buttons.
- i** The remote control for the door drive is not included in the scope of delivery of the garage door opener.

#### Synchronizing the rolling code Requirements:

- The door system uses a rolling code.
  - The vehicle must be within range of the garage door or door drive.
  - The vehicle as well as persons and objects are located outside the range of movement of the door.
- ▶ Press the programming button on the door drive unit.  
Initiate the next step within approximately 30 seconds.

- ▶ Press previously programmed button ①, ② or ③ repeatedly until the door closes. When the door closes, programming is completed.

ⓘ Please also read the operating instructions for the door drive.

### Troubleshooting when programming the remote control

- ▶ Check if the transmitter frequency of remote control ⑤ is supported.
- ▶ Replace the batteries in remote control ⑤.
- ▶ Hold remote control ⑤ at various angles from a distance of 0.4 in (1 cm) to 3 in (8 cm) front of the inside rearview mirror. You should test every position for at least 25 seconds before trying another position.
- ▶ Hold remote control ⑤ at the same angles at various distances in front of the inside rearview mirror. You should test every position for at least 25 seconds before trying another position.
- ▶ Note that some remote controls transmit only for a limited period, press button ⑥ on

remote control ⑤ again before transmission ends.

- ▶ Align the antenna line of the door opener unit with the remote control.

ⓘ Support and additional information on programming:

- On the toll free HomeLink® Hotline on 1-800-355-3515
- On the Internet at <https://www.homelink.com/mercedes>

### Opening or closing the garage door Requirements:

- The corresponding button is programmed to operate the door.
- ▶ Press and hold buttons ①, ② or ③ until the door opens or closes.
- ▶ If indicator lamp ④ flashes yellow after approximately 20 seconds: press and hold the previously pressed button again until the door opens or closes.

### Clearing the garage door opener memory

- ▶ Press and hold buttons ① and ③. Indicator lamp ④ lights up yellow.
- ▶ If indicator lamp ④ flashes green: release buttons ① and ③. The entire memory has been deleted.

### Electric parking brake

#### Electric parking brake function (applying automatically)

**⚠ WARNING** Risk of accident and injury due to children left unattended in the vehicle

If children are left unsupervised in the vehicle, they could, in particular:

- Open doors, thereby endangering other persons or road users.
- Get out and be struck by oncoming traffic.
- Operate vehicle equipment and become trapped, for example.

In addition, the children could also set the vehicle in motion, for example by:

- Releasing the parking brake.
  - Change the transmission position.
  - Start the vehicle.
- ▶ Never leave children unattended in the vehicle.
  - ▶ When leaving the vehicle, always take the SmartKey with you and lock the vehicle.
  - ▶ Keep the SmartKey out of reach of children.

The electric parking brake is applied if the transmission is in position **P** and one of the following conditions is fulfilled:

- The engine is switched off.
- The seat belt tongue is not inserted in the seat belt buckle of the driver's seat and the driver's door is opened.

**i** To prevent application: pull the handle of the electric parking brake.

In the following situations, the electric parking brake is also applied:

- Active Distance Assist DISTRONIC is bringing the vehicle to a standstill.
- The HOLD function is keeping the vehicle stationary.
- Active Parking Assist is keeping the vehicle stationary.

This is the case if one of the following conditions is also fulfilled:

- The engine is switched off.
- The seat belt tongue is not inserted in the seat belt buckle of the driver's seat and the driver's door is opened.
- There is a system malfunction.
- The power supply is insufficient.
- The vehicle is stationary for a lengthy period.

When the electric parking brake is applied, the red **PARK** (USA) or **(P)** (Canada) indicator lamp appears in the instrument cluster.

The electric parking brake is not automatically applied if the engine is switched off by the ECO start/stop function.

### Electric parking brake function (releasing automatically)

The electric parking brake is released when the following conditions are fulfilled:

- The driver's door is closed.
- The engine is running.
- The transmission is in position **D** or **R** and you depress the accelerator pedal or you shift from transmission position **P** to **D** or **R** when on level ground with the driver's door closed.
- If the transmission is in position **R**, the tail-gate must be closed.
- The seat belt tongue is inserted into the seat belt buckle of the driver's seat.

If the seat belt tongue is not inserted into the seat belt buckle of the driver's seat, one of the following conditions must be fulfilled:

- You shift from transmission position **P**.

- You have previously driven at speeds greater than 2 mph (3 km/h).

When the electric parking brake is released, the red **PARK** (USA) or **(P)** (Canada) indicator lamp in the instrument cluster goes out.

### Applying/releasing the electric parking brake manually

#### Applying

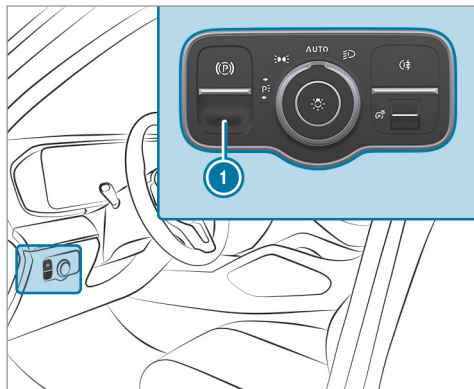

▶ Push handle ①.  
The red **PARK** (USA) or **(P)** (Canada) indicator lamp appears in the instrument cluster.

ⓘ The electric parking brake is only securely applied if the indicator lamp is lit continuously.

#### Releasing

▶ Switch on the ignition.  
▶ Pull handle ①.  
The red **PARK** (USA) or **(P)** (Canada) indicator lamp in the instrument cluster goes out.

#### Emergency braking

▶ Press and hold handle ①.  
As long as the vehicle is driving, the **Please Release Parking Brake** message is displayed.  
When the vehicle has been braked to a standstill, the electric parking brake is applied. The red **PARK** (USA) or **(P)** (Canada) indicator lamp appears in the instrument cluster.

### Information on collision detection on a parked vehicle

If a collision is detected when the tow-away alarm is armed on a locked vehicle, you will receive a notification in the multimedia system when you switch on the ignition.

You will receive information about the following points:

- The area of the vehicle that may have been damaged.
- The force of the impact.

The following situations can lead to inadvertent activation:

- The parked vehicle is moved, e.g. in a two-story garage.
- ⓘ Deactivate the tow-away alarm in order to prevent inadvertent activation. If you deactivate the tow-away alarm, collision detection will also be deactivated.



- ⓘ If the battery is severely discharged, the function for detecting a collision on a parked vehicle is automatically deactivated to facilitate the next engine start.

### System limits

Detection may be restricted in the following situations:

- The vehicle is damaged without impact, e.g. if an outside mirror is torn off or the paint is damaged by a key
- An impact occurs at low speed
- The electric parking brake is not applied

### Notes on parking the vehicle for an extended period

If you leave the vehicle parked for longer than six weeks, it may suffer damage through disuse.

The 12 V battery may also be impaired or damaged by heavy discharging.

- ⓘ Further information can be obtained at a qualified specialist workshop.

### Standby mode (extension of the starter battery's period out of use)

#### Standby mode function

ⓘ This function is not available for all models. If standby mode is activated, energy loss will be minimised during extended periods of non-operation.

Standby mode is characterised by the following:

- The starter battery is preserved.
- The maximum non-operational time appears in the media display.
- The connection to online services is interrupted.
- The ATA (anti-theft alarm system) is not available.
- The interior motion sensor and tow-away alarm functions are not available.
- The function for detecting collisions on a parked vehicle is not available.

If the following conditions are fulfilled, standby mode can be activated or deactivated using the multimedia system:

- The engine is switched off.
- The ignition is switched on.

Exceeding the vehicle's displayed non-operational time may cause inconvenience, i.e. it cannot be guaranteed that the starter battery will reliably start the engine.

The starter battery must be charged first in the following situations:

- The vehicle's non-operational time must be extended.
- The **Battery Charge Insufficient for Standby Mode** message appears in the media display.

ⓘ Standby mode is automatically deactivated when the ignition is switched on.

#### Activating/deactivating standby mode (parking the vehicle for an extended period) Requirements:

- The engine is switched off.

Multimedia system:

→  → Settings → Vehicle

- ▶ Activate or deactivate Standby Mode.
- ▶ Select Yes.

## Driving and driving safety systems

### Driving systems and your responsibility

Your vehicle is equipped with driving systems which assist you in driving, parking and maneuvering the vehicle. The driving systems are only aids. They are not a substitute for your attention to the surroundings and do not relieve you of your responsibility pertaining to road traffic law. The driver is always responsible for maintaining a safe distance to the vehicle in front, for vehicle speed, for braking in good time and for staying in lane. Pay attention to the traffic conditions at all times and intervene when necessary. Be aware of the limitations regarding the safe use of these systems.

Driving systems can neither reduce the risk of accident if you fail to adapt your driving style nor override the laws of physics. They cannot always

take into account road, weather or traffic conditions.

### Information on vehicle sensors and cameras

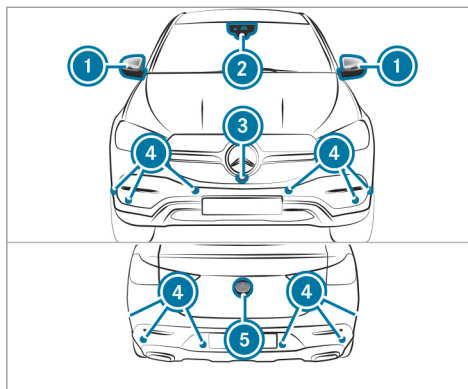

- ① Cameras in the outside mirrors
- ② Multifunction camera
- ③ Front camera

- ④ Ultrasonic sensors
- ⑤ Rear view camera

ⓘ Depending on the vehicle's equipment, the radar sensors are integrated behind the bumpers and/or behind the radiator grill.

Some driving and driving safety systems use cameras as well as radar or ultrasonic sensors to monitor the area in front of, behind or next to the vehicle.

Keep the areas around the sensors and cameras free of dirt, ice or slush (→ page 299). The cameras and sensors must not be covered, for example by bicycle racks, overhanging loads, stickers, foil or foils to protect against stone chipping. Additional license plate brackets can impair the function of the ultrasonic sensors, in particular.

In the event of damage or a severe impact in the area of the sensors, have the function of the sensors checked at a qualified specialist workshop. Have damage or stone chipping in the area of the cameras repaired at a qualified specialist workshop. If the sensors or cameras are damaged, some driving systems and driving safety systems may no longer function properly.

## Overview of driving systems and driving safety systems

- ABS (**A**nti-**l**ock **B**raking **S**ystem) (→ page 175)
- Off-road ABS (→ page 176)
- BAS (**B**rake **A**ssist **S**ystem) (→ page 176)
- ESP® (**E**lectronic **S**tability **P**rogram) (→ page 176)
- ESP® Crosswind Assist (→ page 179)
- ESP® trailer stabilization (→ page 179)
- EBD (**E**lectronic **B**rakeforce **D**istribution) (→ page 179)
- STEER CONTROL (→ page 179)
- Active Brake Assist (→ page 180)<sup>1</sup>
- Cruise control (→ page 185)
- DSR (**D**ownhill **S**peed **R**egulation) (→ page 186)
- Active Distance Assist DISTRONIC (→ page 188)<sup>1</sup>
- Active Speed Limit Assist (→ page 193)<sup>2</sup>
- Route-based speed adaptation (→ page 193)<sup>2</sup>
- Active Steering Assist (→ page 195)<sup>2</sup>
- Active Lane Change Assist (→ page 197)<sup>2</sup>
- Active Emergency Stop Assist (→ page 198)<sup>2</sup>
- Active Traffic Jam Assist (→ page 199)<sup>2</sup>
- Hill Start Assist (→ page 200)
- HOLD function (→ page 200)
- AIRMATIC (→ page 201)
- E-ACTIVE BODY CONTROL (→ page 206)
- Parking Assist PARKTRONIC (→ page 212)
- Rear view camera (→ page 216)
- Surround view camera (→ page 219)
- Active Parking Assist (→ page 223)
- ATTENTION ASSIST (→ page 227)
- Traffic Sign Assist (→ page 229)<sup>1</sup>
- Blind Spot Assist and Active Blind Spot Assist with exit warning (→ page 230)<sup>1</sup>
- Active Lane Keeping Assist (→ page 233)<sup>3</sup>

## Function of ABS

The Anti-lock Brake System (ABS) regulates the brake pressure in critical driving situations:

- During braking, e.g. at full brake application or insufficient tire traction, the wheels are prevented from locking.
- Vehicle steerability while braking is ensured.

If ABS intervenes when braking, you will feel a pulsing in the brake pedal. The pulsating brake pedal can be an indication of hazardous road conditions and can serve as a reminder to take extra care while driving.

<sup>1</sup> This function includes subfunctions which are only available in conjunction with the Driving Assistance Package.

<sup>2</sup> This function is country-dependent and only available in conjunction with the Driving Assistance Package.

<sup>3</sup> This function includes subfunctions which are only available in conjunction with the Driving Assistance Package or only available depending on the country.

### Functions of Off-road ABS

- ① Off-road ABS is activated automatically when you select the  drive program.

Off-road ABS is specially adapted for driving off-road:

- The front wheels lock cyclically during braking.
- The braking distance is shortened due to the digging-in effect.

#### System limits

- Off-road ABS functions at speeds below 25 mph (40 km/h).
- If Off-road ABS intervenes, the ability to steer may be restricted.

### Function of BAS

The Brake Assist System (BAS) supports your emergency braking situation with additional brake force.

If you depress the brake pedal quickly, BAS is activated:

- BAS automatically boosts the brake pressure.
- BAS can shorten the braking distance.
- ABS prevents the wheels from locking.

The brakes will function as usual once you release the brake pedal. BAS is deactivated.

### Functions of ESP®

**⚠ WARNING** Risk of skidding if ESP® is deactivated

If you deactivate ESP®, ESP® cannot carry out vehicle stabilization.

- ▶ ESP® should only be deactivated in the following situations.

**Mercedes-AMG vehicles:** observe the notes in the Supplement. You could otherwise fail to recognize dangers.

The Electronic Stability Program (ESP®) can monitor and improve driving stability and traction in the following situations within physical limits:

- When pulling away on a wet or slippery road.
- When braking.

If the vehicle deviates from the direction desired by the driver, ESP® can stabilize the vehicle by intervening in the following ways:

- One or more wheels are braked.
- The engine output is adapted according to the situation.

ESP® is deactivated if the  ESP® OFF warning lamp lights up continuously in the instrument cluster:

- Driving stability will no longer be improved.
- The drive wheels could spin.
- ETS/4ETS traction control is still active.

- ① When ESP® is deactivated, you are still assisted by ESP® when braking.

If the  ESP® warning lamp flashes in the instrument cluster, one or several vehicle wheels has reached its grip limit:

- Adapt your driving style to suit the current road and weather conditions.
- Do not deactivate ESP®.
- Only depress the accelerator pedal as far as is necessary when pulling away.

It can be advantageous to deactivate ESP® in the following situations to improve traction:

- When using snow chains.
- In deep snow.
- On sand or gravel.

 Spinning the wheels results in a cutting action, which enhances traction.

If the  ESP® warning lamp lights up continuously, ESP® is not available due to a malfunction.

Observe the following information:

- Indicator and warning lamps (→ page 417)
- Display messages (→ page 368)

### ETS/4ETS (Electronic Traction System)

ETS/4ETS traction control is part of ESP® and makes it possible to pull away and accelerate on a slippery road.

If you select the  drive program, a special ETS system specifically suited to off-road terrain is automatically activated.



ETS/4ETS can improve the vehicle's traction by intervening in the following ways:

- The drive wheels are braked individually if they spin.
- More drive torque is transferred to the wheel or wheels with traction.

### ESP® modes

Depending on the selected drive program, the appropriate ESP® mode will be activated automatically. ESP® adapts to different weather and road conditions as well as the driver's preferred driving style. You can select the drive programs using the DYNAMIC SELECT switch (→ page 158).

### ESP® Comfort

- active in drive programs ,  and 
- balance between traction and stability
- recommended for all road surface conditions
- suitable for both dry and difficult road conditions, such as snow or ice, or when the road is wet from rain

### ESP® Sport

- active in drive program 
- continues to offer stability but with a sporty setup
- allows the sporty driver a more active driving style
- only suitable for good road conditions, a dry road surface and a clear stretch of road

### ESP® Sport +

- active in drive program 
- emphasizes the vehicle's own oversteering and understeering characteristics for a more active driving style

- only suitable for good road conditions, a dry road surface and a clear stretch of road

#### Off-road ESP®

- active in drive program 
- intervenes later if there is oversteering or understeering, thus improving traction
- suitable for easily negotiable off-road terrain such as dirt tracks, gravel or sandy surfaces

#### Activating/deactivating ESP® (Electronic Stability Program)

Multimedia system:

→  ▶ Settings ▶ Quick Access

- ① ESP® can only be activated/deactivated using quick access when at least one other function is available in quick access. ESP® can otherwise be found in the Assistance menu.

**Mercedes-AMG vehicles:** observe the notes in the Supplement. You could otherwise fail to recognize dangers.

- ▶ Select ESP.
- ▶ Select On or  Off.

ESP® is deactivated if the  ESP® OFF warning lamp lights up continuously in the instrument cluster.

Observe the information on warning lamps and display messages which may be shown in the instrument cluster.

#### Activating/deactivating ESP® (vehicles with E-Active Body Control)

**Mercedes-AMG vehicles:** observe the notes in the Supplement. You could otherwise fail to recognize dangers.

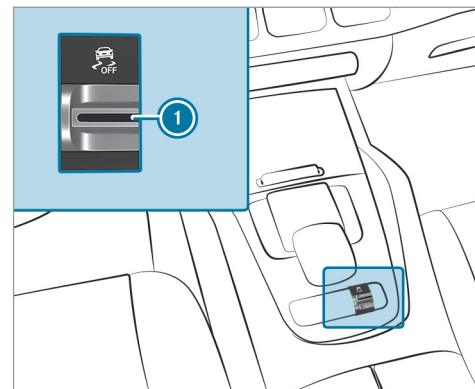

- ▶ Pull rocker switch ①.

ESP® is deactivated if the  ESP® OFF warning lamp lights up continuously in the instrument cluster.

Observe the information on warning lamps and display messages which may be shown in the instrument cluster.

### Function of ESP® Crosswind Assist

ESP® Crosswind Assist detects sudden gusts of side wind and helps the driver to keep the vehicle in the lane:

- ESP® Crosswind Assist is active at vehicle speeds between approx. 47 mph (75 km/h) and 125 mph (200 km/h) when driving straight ahead or cornering slightly.
- The vehicle is stabilized by means of individual brake application on one side.

### Function of ESP® trailer stabilization

**⚠ WARNING** Risk of accident in poor road and weather conditions

In poor road and weather conditions, the trailer stabilization cannot prevent lurching of the vehicle/trailer combination. Trailers with a high center of gravity may tip over before ESP® detects this.

▶ Always adapt your driving style to suit the current road and weather conditions.

When driving with a trailer, ESP® can stabilize your vehicle if the trailer begins to swerve from side to side:

- ESP® trailer stabilization is active above speeds of 40 mph (65 km/h).
- Slight swerving is reduced by means of a targeted, individual brake application on one side.
- In the event of severe swerving, the engine output is also reduced and all wheels are braked.

ESP® trailer stabilization may be impaired or may not function if:

- The trailer is not connected correctly or is not detected properly by the vehicle.

### Function of EBD

Electronic Brakeforce Distribution (EBD) is characterized by the following:

- Monitoring and regulating the brake pressure on the rear wheels.
- Improved driving stability when braking, especially on bends.

### Function of STEER CONTROL

STEER CONTROL helps you by transmitting a noticeable steering force to the steering wheel in the direction required for vehicle stabilization.

This steering recommendation is given particularly in the following situations:

- Both right wheels or both left wheels are on a wet or slippery road surface when you brake.
- The vehicle starts to skid.

### System limits

STEER CONTROL may be impaired or may not function in the following situations:

- ESP® is deactivated.
- ESP® is malfunctioning.
- The steering is malfunctioning.

If ESP® is malfunctioning, you will be assisted further by the electric power steering.

### Function of Active Brake Assist

Active Brake Assist consists of the following functions:

- Distance warning function
- Autonomous braking function
- Situation-dependent braking assistance
- **Vehicles with Driving Assistance Package:** Evasive Steering Assist and cornering function

Active Brake Assist can help you to minimize the risk of a collision with vehicles, cyclists or

pedestrians, or reduce the effects of such a collision.

If Active Brake Assist has detected a risk of collision, a warning tone sounds and the  distance warning lamp lights up in the instrument cluster.

**Vehicles with PRE-SAFE®:** depending on the country, an additional haptic warning occurs in the form of slight, repeated tensioning of the seat belt.

If you do not react to the warning, autonomous braking can be initiated in critical situations.

In especially critical situations, Active Brake Assist can initiate autonomous braking directly. In this case, the warning lamp and warning tone occur simultaneously with the braking application.

If you apply the brake yourself in a critical situation or apply the brake during autonomous braking, situation-dependent braking assistance occurs. The brake pressure increases up to maximum full-stop braking if necessary.

Observe the notes on driving systems and your responsibility; you may otherwise fail to recognize dangers (→ page 174).

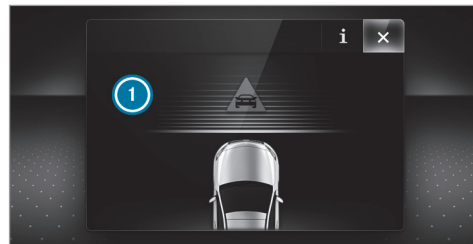

If autonomous braking or situation-dependent braking assistance has occurred, display  appears in the multifunction display and then automatically goes out after a short time.

If the autonomous braking function or the situation-dependent braking assistance is triggered, additional preventive measures for occupant protection (PRE-SAFE®) may also be initiated.



**▲ WARNING** Risk of an accident caused by limited detection performance of Active Brake Assist

Active Brake Assist cannot always clearly identify objects and complex traffic situations.

- ▶ Always pay careful attention to the traffic situation; do not rely on Active Brake Assist alone. Active Brake Assist is only an aid. The driver is responsible for maintaining a sufficiently safe distance to the vehicle in front, vehicle speed and for braking in good time.
- ▶ Be prepared to brake or swerve if necessary.

Also observe the system limits of Active Brake Assist.

### The individual subfunctions are available in various speed ranges:

The distance warning function can issue a warning in the following situations:

- From approximately 4 mph (7 km/h), if your vehicle is critically close to a vehicle, cyclist or pedestrian, you will hear an intermittent warning tone and the  distance warning lamp lights up in the instrument cluster.

**Vehicles with PRE-SAFE®:** depending on the country, an additional haptic warning occurs in the form of slight, repeated tensioning of the seat belt.

Brake immediately or take evasive action, provided it is safe to do so and the traffic situation allows this.

### Distance warning function (vehicles without Driving Assistance Package)

The distance warning function can aid you in the following situations with an intermittent warning tone and a warning lamp:

- at speeds up to approximately 155 mph (250 km/h) when approaching vehicles ahead
- at speeds up to approximately 50 mph (80 km/h) when approaching stationary vehicles, moving pedestrians and cyclists ahead
- at speeds up to approximately 37 mph (60 km/h) when approaching crossing cyclists

### Distance warning function (vehicles with Driving Assistance Package)

The distance warning function can aid you in the following situations with an intermittent warning tone and a warning lamp:

- at speeds up to approximately 155 mph (250 km/h) when approaching vehicles ahead

## 182 Driving and parking

---

- at speeds up to approximately 62 mph (100 km/h) when approaching stationary vehicles
- at speeds up to approximately 50 mph (80 km/h) when approaching moving pedestrians and cyclists ahead
- at speeds up to approximately 43 mph (70 km/h) when approaching stationary pedestrians, crossing vehicles and stationary and crossing cyclists

### **Autonomous braking function (vehicles without Driving Assistance Package)**

If the vehicle is traveling at speeds above approximately 4 mph (7 km/h), the autonomous braking function may intervene in the following situations:

- at speeds up to approximately 124 mph (200 km/h) when approaching vehicles ahead
- at speeds up to approximately 50 mph (80 km/h) when approaching cyclists ahead

- at speeds up to approximately 37 mph (60 km/h) when approaching moving pedestrians and crossing cyclists
- at speeds up to approximately 31 mph (50 km/h) when approaching stationary vehicles

### **Autonomous braking function (vehicles with Driving Assistance Package)**

If the vehicle is traveling at speeds above approximately 4 mph (7 km/h), the autonomous braking function may intervene in the following situations:

- at speeds up to approximately 155 mph (250 km/h) when approaching vehicles ahead
- at speeds up to approximately 62 mph (100 km/h) when approaching stationary vehicles
- at speeds up to approximately 50 mph (80 km/h) when approaching cyclists ahead
- at speeds up to approximately 43 mph (70 km/h) when approaching stationary and

moving pedestrians, crossing vehicles and stationary and crossing cyclists

### **Situation-dependent braking assistance (vehicles without Driving Assistance Package)**

The situation-dependent braking assistance can intervene from a speed of approximately 4 mph (7 km/h) in the following situations:

- at speeds up to approximately 155 mph (250 km/h) when approaching vehicles ahead
- at speeds up to approximately 50 mph (80 km/h) when approaching stationary vehicles and vehicles ahead
- at speeds up to approximately 37 mph (60 km/h) when approaching moving pedestrians and crossing cyclists

### Situation-dependent braking assistance (vehicles with Driving Assistance Package)

The situation-dependent braking assistance can intervene from a speed of approximately 4 mph (7 km/h) in the following situations:

- at speeds up to approximately 155 mph (250 km/h) when approaching vehicles ahead
- at speeds up to approximately 62 mph (100 km/h) when approaching stationary vehicles
- at speeds up to approximately 50 mph (80 km/h) when approaching cyclists ahead
- at speeds up to approximately 37 mph (60 km/h) when approaching stationary and moving pedestrians, crossing vehicles and stationary and crossing cyclists

### Canceling a brake application of Active Brake Assist

You can cancel a brake application of Active Brake Assist at any time by:

- Activating kickdown.
- Releasing the brake pedal.

Active Brake Assist may cancel the brake application when one of the following conditions is fulfilled:

- You maneuver to avoid the obstacle.
- There is no longer a risk of collision.
- An obstacle is no longer detected in front of your vehicle.

### Evasive Steering Assist (only vehicles with Driving Assistance Package)

Evasive Steering Assist has the following characteristics:

- The ability to detect stationary or moving pedestrians.
- Assistance through power-assisted steering if it detects a swerving maneuver.
- Activation by an abrupt steering movement during a swerving maneuver.
- Assistance during swerving and straightening of the vehicle.
- Reaction from a speed of approximately 12 mph (20 km/h) up to a speed of approximately 43 mph (70 km/h).

You can prevent the assistance at any time by actively steering.

### Cornering function (only vehicles with Driving Assistance Package)

If a danger of collision from an oncoming vehicle is detected when turning across an oncoming lane, autonomous braking can be initiated at speeds below 9 mph (15 km/h) before you have left the lane in which you are driving.

#### **WARNING** Risk of accident despite Evasive Steering Assist

Evasive Steering Assist cannot always recognize objects or complex traffic situations clearly.

Moreover, the steering support provided by Evasive Steering Assist is not sufficient to avoid a collision.

- ▶ Always pay careful attention to the traffic situation; do not rely on Evasive Steering Assist alone.
- ▶ Be prepared to brake or swerve if necessary.

- ▶ End the support by actively steering in non-critical situations.
- ▶ Drive at an appropriate speed if there are pedestrians close to the path of your vehicle.

### System limits

Full system performance is not available for a few seconds after switching on the ignition or after driving off.

The system may be impaired or may not function in the following situations:

- In snow, rain, fog, heavy spray, if there is glare, in direct sunlight or in greatly varying ambient light.
- If the sensors are dirty, fogged up, damaged or covered.
- If the sensors are impaired due to interference from other radar sources, e.g. strong radar reflections in parking garages.
- If a loss of tire pressure or a faulty tire has been detected and displayed.
- If DSR is active.

- In complex traffic situations where objects cannot always be clearly identified.
  - If pedestrians or vehicles move quickly into the sensor detection range.
  - If pedestrians are hidden by other objects.
  - If the typical outline of a pedestrian cannot be distinguished from the background.
  - If a pedestrian is not detected as such, e.g. due to special clothing or other objects.
  - On bends with a tight radius.
- i** The Active Brake Assist sensors adjust automatically while a certain distance is being driven after the vehicle has been delivered. Active Brake Assist is unavailable or only partially available during this teach-in period.

### Setting Active Brake Assist

#### Requirements:

- The ignition is switched on.

Multimedia system:

➔  ➔ Settings ➔ Assistance  
➔ Active Brake Assist

- ▶ Select the desired setting.  
The setting is retained when the engine is next started.

#### Deactivating Active Brake Assist

- i** It is recommended that you always leave Active Brake Assist activated.
- ▶ Select **Off**.  
The distance warning function, the autonomous braking function and the Evasive Steering Assist are deactivated.  
When the vehicle is next started, the middle setting is automatically selected.
- i** If Active Brake Assist is deactivated, the  symbol appears in the status bar of the multifunction display.

## Speed control cruise control

### Function of cruise control

Cruise control regulates the speed to the value selected by the driver.



If you accelerate to overtake, for example, the stored speed is not deleted. If you remove your foot from the accelerator pedal after overtaking, cruise control will resume speed regulation back to the stored speed.

Cruise control is operated using the corresponding steering wheel buttons. You can store any speed above 15 mph (20 km/h) up to the maximum design speed.

Observe the notes on driving systems and your responsibility; you may otherwise fail to recognize dangers (→ page 174).

**Mercedes-AMG vehicles:** Cruise control is available up to a maximum speed of 155 mph (250 km/h).

### Displays on the multifunction display

-  (gray): cruise control is selected but not yet activated.
-  (green): cruise control is active.

A stored speed appears along with the  display.

 The segments between the stored speed and the end of the segment display light up in the speedometer.

### System limits

Cruise control may be unable to maintain the stored speed on uphill gradients. The stored speed is resumed when the gradient evens out.

Change into a lower gear in good time on long and steep downhill gradients. Take particular note of this when driving a laden vehicle. By doing so, you will make use of the braking effect of the engine. This relieves the load on the brake system and prevents the brakes from overheating and wearing too quickly.

Do not use cruise control in the following situations:

- In traffic situations which require frequent changes of speed, e.g. in heavy traffic, on winding roads.
- On slippery roads. Accelerating can cause the drive wheels to lose traction and the vehicle could then skid.

- If you are driving when visibility is poor.

### Operating cruise control

 **WARNING** Risk of accident due to stored speed

If you call up the stored speed and this is lower than your current speed, the vehicle decelerates.

 Take into account the traffic situation before calling up the stored speed.

### Requirements:

- ESP® must be activated, but not intervening.
- The vehicle speed is at least 15 mph (20 km/h).
- The transmission is in position .

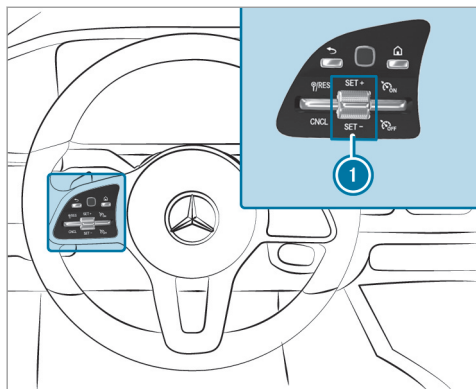



### Operating cruise control

- ▶ Press the rocker switch on the steering wheel control panel up or down to the desired position.

### Activating cruise control





- ▶ Select  with the right rocker switch.

### Activating cruise control

- ▶ Press rocker switch ① up  or down . The current speed is stored and maintained by the vehicle.
- or
- ▶ Select  with the left rocker switch. The last stored speed is called up and maintained by the vehicle.
- If the last stored speed has previously been deleted, the current vehicle speed is stored.

- ① When you switch off the vehicle, the last speed stored is cleared.

### Increasing/decreasing the stored speed

- ▶ 1 mph (1 km/h): press rocker switch ① up  or down  to the pressure point.
- or
- ▶ 5 mph (10 km/h): press rocker switch ① up  or down  beyond the pressure point.
- or
- ▶ Accelerate the vehicle to the desired speed and press rocker switch ① up .

### Adopting a detected speed

- ▶ Activate cruise control or the variable limiter.
- ▶ If a traffic sign has been detected and is displayed in the instrument cluster: select  with the left rocker switch. The maximum permissible speed shown by the traffic sign is stored and the vehicle maintains or does not exceed this speed.

### Deactivating cruise control

- ▶ Select  with the left rocker switch.

### Deactivating cruise control

- ▶ Select  with the right rocker switch.
- ① If you brake, deactivate ESP® or if ESP® intervenes, cruise control is deactivated.

### DSR (Downhill Speed Regulation)

#### Function of DSR (Downhill Speed Regulation)

DSR is an aid to assist you when driving downhill. It keeps the speed of travel at the selected target speed. The steeper the downhill gradient, the greater the DSR braking effect on the vehicle. On flat stretches of road and uphill gradi-

ents, the DSR brakes the vehicle minimally or not at all.

When DSR is activated and the transmission is in position **D**, **R** or **N**, DSR controls the driving speed. The target speed can be set to a value between 1 mph (2 km/h) and 11 mph (18 km/h). By braking or accelerating, you can drive at a higher or lower speed than the target speed at any time.

DSR is deactivated automatically if you drive at speeds greater than 28 mph (45 km/h) or select drive program **S** or **S+**. The  Off message then appears in the multifunction display. The status indicator in the multifunction display disappears. You also hear a warning tone.

### Notes on DSR

**⚠ WARNING** Risk of skidding and accident when DSR is activated on slippery road surfaces

If the driven speed and the target speed differ, the wheels may lose traction.

▶ Take into account the road surface and the difference between the driving

speed and target speed before activating DSR.

Observe the notes on driving systems and your responsibility; you may otherwise fail to recognize dangers (→ page 174).

You are always responsible for keeping control of the vehicle and for assessing whether the downhill gradient can be negotiated. Depending on road surface and tires, DSR may not always be able to keep to the target speed. Select a target speed suitable for the environmental conditions and also apply the brakes yourself if required.

### Activating/deactivating DSR (vehicles with E-Active Body Control)

#### Requirements:

- You are driving at 24 mph (40 km/h) or slower.

If the current vehicle speed is too high, the **Max. Speed 24 mph** message appears in the multifunction display.

- You have not selected drive program **S** or **S+**.

- Active Distance Assist DISTRONIC is deactivated.

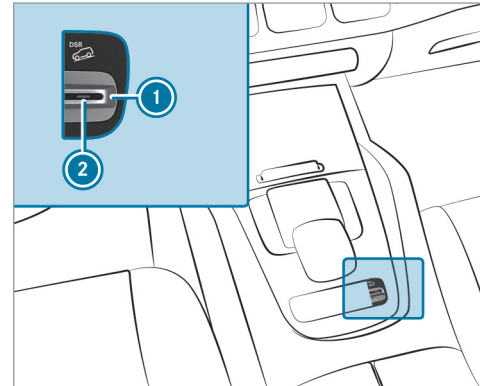

- ▶ **To activate:** pull rocker switch **1**. Indicator lamp **2** lights up.

The  symbol appears in the multifunction display.

- ▶ **To deactivate:** pull rocker switch ①. Indicator lamp ② and the  symbol go out.

### Activating or deactivating DSR (Downhill Speed Regulation)

#### Requirements:

- You are driving at 25 mph (40 km/h) or slower.  
If the current vehicle speed is too high, the **Max. Speed 24 mph** message appears in the multifunction display.
- Active Distance Assist DISTRONIC is deactivated.

Multimedia system:

→  → Settings → Quick Access

- ▶ Select .  
A status display appears in the multifunction display when the function is activated.

### Changing the target speed

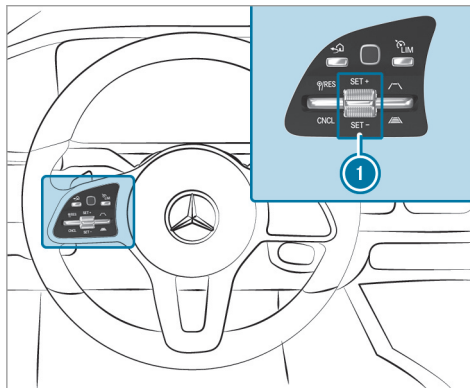

- ▶ **To increase/reduce the target speed:** press rocker switch ① up **SET/+** or down **SET/-** to the point of resistance. The selected target speed increases or decreases by 1 mph (1 km/h) and appears along with the  symbol in the multifunction display.

### Active Distance Assist DISTRONIC

#### Function of Active Distance Assist DISTRONIC

Active Distance Assist DISTRONIC maintains the set speed on free-flowing roads. If vehicles in front are detected, the set distance is maintained, if necessary, until the vehicle comes to a halt. The vehicle accelerates or brakes depending on the distance to the vehicle in front and the set speed. The speed and distance to the vehicle in front are set and saved using the steering wheel.

Available speed range:

- **Vehicles without Driving Assistance Package:** 15 mph (20 km/h) - 120 mph (200 km/h)
- **Vehicles with Driving Assistance Package:** 15 mph (20 km/h) - 130 mph (210 km/h)



Other features of Active Distance Assist DISTRONIC:

- Adjusts the driving style depending on the selected drive program (fuel efficient, comfortable or dynamic)
- Initiates acceleration to the stored speed if the turn signal indicator is switched on to change to the overtaking lane
- **Vehicles with Driving Assistance Package:**
  - Reacts to stationary vehicles detected in urban speed ranges (except bicycles and motorcycles)
  - Takes one-sided overtaking restrictions into account on freeways or on multi-lane roads with separate roadways (country-dependent)

**Vehicles with Active Parking Assist and Driving Assistance Package:** if the vehicle has been braked to a standstill on multi-lane, separate roadways by Active Distance Assist DISTRONIC, it can automatically follow the vehicle in front, driving off again within 30 seconds.

If a critical situation is detected when driving off, a visual and acoustic warning is given indicating that the driver must now take control of the vehicle. The vehicle is not accelerated any further.

Observe the notes on driving systems and your responsibility; you may otherwise fail to recognize dangers (→ page 174).

#### Active Distance Assist DISTRONIC displays in the instrument cluster

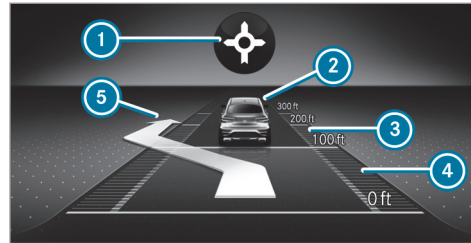

Assistant display

- ① Route-based speed adaptation: type of route event (→ page 193)
- ② Vehicle in front

- ③ Distance indicator
- ④ Set specified distance
- ⑤ Active Lane Change Assist lane change display

#### Permanent status display of Active Distance Assist DISTRONIC

- (white): Active Distance Assist DISTRONIC selected, specified distance set
- (green): Active Distance Assist DISTRONIC active, specified distance set and vehicle detected
- : Route-based speed adaptation active (→ page 193).

The stored speed is shown along with the permanent status display and highlighted on the speedometer. When Active Distance Assist DISTRONIC is passive, the speed is grayed out.

- ① On freeways or high-speed major roads, the green vehicle symbol is displayed cyclically when the vehicle is ready to pull away.

- ① If you depress the accelerator pedal beyond the setting of the Active Distance Assist DISTRONIC, the system is switched to passive mode. The  **Suspended** message appears in the multifunction display.

### Display on the speedometer

The stored speed is highlighted on the speedometer. If the speed of the vehicle in front or the speed adjustment is less than the stored speed due to the route event ahead, the segments on the speedometer light up. Deactivation of Active Distance Assist DISTRONIC, as well as alterations to the speed due to manual or automatic adoption of the maximum permissible speed, are displayed in the control feedback of the multifunction display on a single line.

### System limits

The system may be impaired or may not function in the following situations, for example:

- In snow, rain, fog, heavy spray, if there is glare, in direct sunlight or in greatly varying ambient light.

- If there is swirling dust, e.g. when driving off-road or on sandy surfaces.
- The windshield in the area of the camera is dirty, fogged up, damaged or covered.
- If the radar sensors are dirty or covered.
- In parking garages or on roads with steep uphill or downhill gradients.
- If there are narrow vehicles in front, such as bicycles or motorcycles.

In addition, on slippery roads, braking or accelerating can cause one or several wheels to lose traction and the vehicle could then skid.

Do not use Active Distance Assist DISTRONIC in these situations.

**⚠ WARNING** Risk of accident from acceleration or braking by Active Distance Assist DISTRONIC

Active Distance Assist DISTRONIC may accelerate or brake in the following cases, for example:

- If the vehicle pulls away using Active Distance Assist DISTRONIC.
  - If the stored speed is called up and is considerably faster or slower than the currently driven speed.
  - If Active Distance Assist DISTRONIC no longer detects a vehicle in front or does not react to relevant objects.
- ▶ Always carefully observe the traffic conditions and be ready to brake at all times.
- ▶ Take into account the traffic situation before calling up the stored speed.

**⚠ WARNING** Risk of accident due to insufficient deceleration by Active Distance Assist DISTRONIC

Active Distance Assist DISTRONIC brakes your vehicle with up to 50% of the possible deceleration. If this deceleration is not sufficient, Active Distance Assist DISTRONIC alerts you with a visual and acoustic warning.

- ▶ Adjust your speed and maintain a suitable distance from the vehicle in front.
- ▶ Brake the vehicle yourself and/or take evasive action.

**⚠ WARNING** Risk of accident if detection function of Active Distance Assist DISTRONIC is impaired

Active Distance Assist DISTRONIC does not react or has a limited reaction:

- when driving on a different lane or when changing lanes

- to pedestrians, animals, bicycles or stationary vehicles, or unexpected obstacles
- to complex traffic conditions
- to oncoming vehicles and crossing traffic

As a result, Active Distance Assist DISTRONIC may neither give warnings nor intervene in such situations.

- ▶ Always observe the traffic conditions carefully and react accordingly.

**Operating Active Distance Assist DISTRONIC Requirements:**

- The electric parking brake is released.
- ESP® is activated and is not intervening.
- The transmission is in position **D**.
- The driver's door is closed.
- Check of the radar sensor system has been successfully completed.
- Parking Assist PARKTRONIC is not being used to park the vehicle or to exit from a parking space.
- DSR is deactivated.

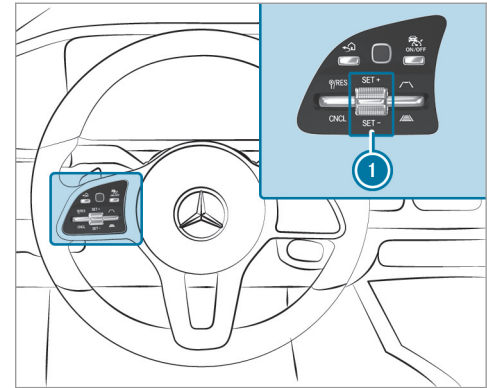

- ▶ **To operate Active Distance Assist DISTRONIC:** press the rocker switch on the steering wheel control unit up or down to the desired position.

**Activating/deactivating Active Distance Assist DISTRONIC**

- ▶ Press the  button.

**Activating Active Distance Assist DISTRONIC**

- ▶ **To activate without a stored speed:** press rocker switch ① up **SET+** or down **SET-**, or select **RES/Ⓟ** with the left rocker switch.

or

- ▶ **To activate with a stored speed:** select **RES/Ⓟ** with the left rocker switch.
- ▶ Remove your foot from the accelerator pedal. The current speed is stored and maintained by the vehicle.

#### Adopting a detected speed limit

- ▶ Activate Active Distance Assist DISTRONIC.
- ▶ If a traffic sign has been detected and is displayed in the instrument cluster: select **RES/Ⓟ** with the left rocker switch. The maximum permissible speed on the traffic sign is adopted as the stored speed. The vehicle adapts its speed to that of the vehicle in front, but only up to the stored speed.

#### Pulling away with Active Distance Assist DISTRONIC

- ▶ Activate Active Distance Assist DISTRONIC and remove your foot from the brake pedal.

- ▶ Select **RES/Ⓟ** with the left rocker switch.
- or

- ▶ Depress the accelerator pedal briefly and firmly. The functions of Active Distance Assist DISTRONIC continue to be carried out.

#### Deactivating Active Distance Assist DISTRONIC

**⚠ WARNING** Risk of accident due to Active Distance Assist DISTRONIC still being activated when you leave the driver's seat

If you leave the driver's seat while the vehicle is being braked by Active Distance Assist DISTRONIC only, the vehicle can roll away.

- ▶ Always deactivate Active Distance Assist DISTRONIC and secure the vehicle to prevent it from rolling away before you leave the driver's seat.

- ▶ Select **CNCL** with the left rocker switch.

- ① If you brake, deactivate ESP® or if ESP® intervenes, Active Distance Assist DISTRONIC is deactivated.

#### Increasing or decreasing the speed

- ▶ 1 mph (1 km/h): press rocker switch ① up **SET+** or down **SET-** to the pressure point.



or

- ▶ 5 mph (10 km/h): press rocker switch ① up **SET+** or down **SET-** beyond the pressure point.

or

- ▶ Accelerate the vehicle to the desired speed and press rocker switch ① up **SET+**.

#### Changing the specified distance to the vehicle in front

- ▶ **To reduce the specified distance:** press the right rocker switch up (.
- ▶ **To increase the specified distance:** press the right rocker switch down (.

### Function of Active Speed Limit Assist

If speed limit change between 12 mph (20 km/h) and 80 mph (130 km/h) is detected and the automatic adoption of speed limits is active, it will be automatically adopted as the stored speed (→ page 230).

The driven speed is adjusted when the vehicle is level with the traffic sign at the latest. In the case of signs indicating entry into an urban area, the speed is adapted according to the speed permitted within the urban area. The speed limit display in the Instrument Display is always updated when the vehicle is level with the traffic sign.

If there is no speed restriction on an unlimited stretch of road (e.g. on a freeway), the recommended speed is automatically adopted as the stored speed. The system uses the speed stored on an unlimited stretch of road as the recommended speed. If you do not alter the stored speed on an unlimited stretch of road, the recommended speed is 80 mph (130 km/h).

If Active Distance Assist DISTRONIC has been put into passive mode by pressing the accelera-

tor pedal, only speed limits which are higher than the set speed are adopted.

Observe the notes on driving systems and your responsibility; you may otherwise fail to recognize dangers (→ page 174).

#### System limits

The system limits of Traffic Sign Assist apply to the detection of traffic signs (→ page 229).

Speed limits below 12 mph (20 km/h) are not automatically adopted by the system as the stored speed. Temporary speed restrictions (e.g. for a certain time or due to weather conditions) cannot be properly detected by the system. The maximum permissible speed applying to a vehicle with a trailer is not detected by the system.

Adjust the speed in these situations.

**▲ WARNING** Risk of accident due to Active Speed Limit Assist adapting the vehicle's speed

The speed adopted by Active Speed Limit Assist may be too high or incorrect in some individual cases, such as:

- at speed limits below 12 mph (20 km/h)
  - in wet conditions or in fog
  - when towing a trailer
- ▶ Ensure that the driven speed complies with traffic regulations.
- ▶ Adjust the driving speed to suit current traffic and weather conditions.

### Function of route-based speed adaptation

When Active Distance Assist DISTRONIC is activated, the vehicle speed will be adapted accordingly to the route events ahead. Depending on the drive program selected, the vehicle negotiates a route event ahead in a fuel-saving, comfortable or dynamic manner. When the route event has been passed, the vehicle accelerates again to the stored speed. The set distance to the vehicle in front, vehicles detected ahead and speed restrictions ahead are taken into account.

Route-based speed adaptation can be configured in the multimedia system (→ page 194).

The following route events are taken into account:

- Curves
- T-intersections, roundabouts and toll stations
- Turns and exits
- Traffic jams ahead (only with Live Traffic )

**i** When the toll station is reached, Active Distance Assist DISTRONIC adopts the speed as the stored speed.

Also, the speed is reduced if the turn signal indicator to change lanes is switched on and one of the following situations is detected:

- Turning off at intersections
- Driving on slowing-down lanes
- Driving on lanes adjacent to slowing-down lanes

The driver is responsible for choosing the right speed and observing other road users. This applies in particular to intersections, roundabouts and traffic lights, as route-based speed adaptation does not brake the vehicle to a standstill.

When route guidance is active, the first speed adjustment is carried out automatically. If the turn signal indicator is switched on, the selected route is confirmed and further speed adjustment is activated.

Speed adaptation is canceled in the following cases:

- If the turn signal indicator is switched off before the route event.
- If the driver depresses the accelerator or brake pedal during the process.

### System limits

Route-based speed adaptation does not take right of way regulations into account. The driver is responsible for complying with road traffic regulations and driving at a suitable speed.

In difficult conditions, the speed selection made by the system may not always be suitable:

- unclear roads
- road narrowing
- wet road surfaces, snow or ice
- when towing a trailer

In these situations the driver must intervene accordingly.

**⚠ WARNING** Risk of accident in spite of route-based speed adaptation

Route-based speed adaptation can malfunction or be temporarily unavailable in the following situations:

- If the driver does not follow the calculated route
- If map data is not up-to-date or available
- In the event of roadworks
- In bad weather or road conditions
- If the accelerator pedal is depressed
- In the event of electronically displayed speed limitations

▶ Adapt the speed to the traffic situation.

### Setting route-based speed adaptation

#### Requirements:

- Active Distance Assist DISTRONIC is activated.

Multimedia system:

→  » Settings » Assistance  
» Route-based Speed

- ▶ Activate or deactivate the function. When the function is active, the vehicle speed is adjusted depending on the route events ahead.

- ⓘ Further information on the route-based speed adaptation (→ page 193).

## Active Steering Assist

### Function of Active Steering Assist







Active Steering Assist is only available up to a speed of 130 mph (210 km/h). The system helps you to stay in the center of the lane by means of moderate steering interventions. Depending on the speed driven, Active Steering Assist uses the vehicles ahead and lane markings as a reference.

- ⓘ Depending on the country, in the lower speed range Active Steering Assist can use

the surrounding traffic as a reference. If necessary, Active Steering Assist can then also provide assistance when driving outside the center of the lane, for example to form a rescue lane.

If the detection of lane markings and vehicles ahead is impaired, Active Steering Assist switches to passive mode. The system provides no support in this case.

### Status display of Active Steering Assist in the multifunction display

-  (gray): activated and passive
  -  (green): activated and active
  -  (red): system limits detected
  -  (white, red hands): "hands on the steering wheel" prompt
- ⓘ During the transition from active to passive status, the  symbol is shown as enlarged and flashing. Once the system is passive, the  symbol is shown as gray in the multifunction display.
  - ⓘ Depending on the selected vehicle settings, Active Steering Assist may be unavailable.

### Steering and touch detection

The driver is required to keep their hands on the steering wheel at all times and be able to intervene at any time to correct the course of the vehicle and keep it in lane. The driver must expect a change from active to passive mode or vice versa at any time.



If the system detects that the driver has not steered the vehicle for a considerable period of time or has removed their hands from the steering wheel, display ① appears. If the driver still does not steer the vehicle, a warning tone sounds in addition to the visual warning message.

If the driver does not react to this warning for a considerable period, an emergency stop is initiated (→ page 198).

The warning is not issued or is stopped when the driver gives confirmation to the system:

- The driver steers the vehicle.
- The driver presses a steering wheel button or operates Touch Control.

If Active Steering Assist detects that a system limit has been reached, a visual warning is issued and a warning tone sounds.

Observe the notes on driving systems and your responsibility; you may otherwise fail to recognize dangers (→ page 174).

### System limits

Active Steering Assist has a limited steering torque for lateral guidance. In some cases, the steering intervention is not sufficient to keep the vehicle in the lane or to drive through exits.

The system may be impaired or may not function in the following instances:

- There is poor visibility, e.g. due to snow, rain, fog, heavy spray, greatly varying ambient light or strong shadows on the road.
- There is glare, e.g. from oncoming traffic, direct sunlight or reflections.
- Insufficient road illumination.
- The windshield is dirty, fogged up, damaged or covered in the vicinity of the camera, e.g. by a sticker.
- No, or several, unclear lane markings are present for one lane, or the markings change quickly, for example, in a construction area or intersections.
- The lane markings are worn away, dark or covered up, e.g. by dirt or snow.
- If the distance to the vehicle in front is too short and thus the lane markings cannot be detected.
- The road is narrow and winding.
- There are obstacles on the lane or projecting out into the lane, such as object markers.

The system does not provide assistance in the following conditions:

- On tight curves and when turning.
- When crossing intersections.
- At roundabouts or toll stations.
- When towing a trailer.
- When the tire pressure is too low.

**⚠ WARNING** Risk of accident if Active Steering Assist unexpectedly stops functioning

If the system limits of Active Steering Assist are reached there is no guarantee that the system will remain active or will keep the vehicle in lane.

- ▶ Always keep your hands on the steering wheel and observe the traffic carefully.
- ▶ Always steer the vehicle paying attention to traffic conditions.



**⚠ WARNING** Risk of accident if Active Steering Assist unexpectedly intervenes

The detection of lane markings and objects may malfunction and cause unexpected steering interventions.

▶ Steer according to traffic conditions.

### Activating/deactivating Active Steering Assist

#### Requirements:

- ESP® is activated, but is not intervening.
- Active Distance Assist DISTRONIC is activated.

Multimedia system:

→  » Settings » Quick Access

▶ Select  Steering Assist.

### Function of Active Lane Change Assist

Active Lane Change Assist supports the driver when changing lanes by applying steering torque if the driver operates a turn signal indicator.

Observe the notes on driving systems and your responsibility; you may otherwise fail to recognize dangers (→ page 174).

Assistance when changing lanes is provided if all the following conditions are met:

- You are driving on a freeway or road with multiple lanes in the direction of travel.
- The neighboring lane is separated by a broken lane marking.
- No vehicle is detected in the adjacent lane.
- The driven speed is between 50 mph (80 km/h) and 110 mph (180 km/h).
- Active Lane Change Assist is switched on in the multimedia system.
- Active Steering Assist is activated and active.

If no vehicle is detected in the adjacent lane and a lane change is permitted, the lane change begins after the driver has activated the turn signal indicator. This is shown to the driver with a green arrow next to the  steering wheel symbol. The **Lane Change to the Left** message, for example, also appears. If Active Lane Change Assist has been activated with the turn signal

indicator but a lane change is not immediately possible, a gray arrow appears next to the  steering wheel symbol, which remains green.

When the lane change assistance starts, the turn signal indicator is automatically activated along with the display in the multifunction display.

If the assistance graphic is shown when changing lanes, the lane change display appears with an additional arrow pointing towards the adjacent lane (→ page 188)

If a lane change is not possible, the arrow is faded out after a few seconds and a new lane change must be initiated. An immediate lane change is only possible on freeway sections without speed limits.

If the system is impaired, Active Lane Change Assist may be canceled. The **Lane Change Canceled** message appears in the multifunction display.

In addition, a warning tone may sound.

**▲ WARNING** Risk of accident when changing lane to an occupied adjacent lane

Lane Change Assist cannot always clearly detect if the adjacent lane is free.

The lane change might be initiated although the adjacent lane is not free.

- ▶ Before changing lanes, make sure that the neighboring lane is free and there is no danger to other road users.
- ▶ Monitor the lane change.

**▲ WARNING** Risk of accident if Lane Change Assist unexpectedly stops functioning

If the system limitations for Lane Change Assist have been reached, there is no guarantee that the system will remain active.

Lane Change Assist cannot then assist you by applying steering torques.

- ▶ Always monitor the lane change and keep your hands on the steering wheel.

Observe the traffic conditions and steer and/or brake if necessary.

### System limits

The system limitations of Active Steering Assist apply to Active Lane Change Assist (→ page 195).

The system may also be impaired or may not function in the following situations:

- The sensors in the rear bumper are dirty, damaged or covered by a sticker or ice and snow, for example.
  - The exterior lighting shows a defect.
- i** The Active Lane Change Assist sensors adjust automatically while a certain distance is being driven after the vehicle has been delivered. Active Lane Change Assist is unavailable or only partially available during this teach-in process; no arrow appears next to the  Active Steering Assist symbol when the turn signal indicator is activated.

### Activating/deactivating Active Lane Change Assist

Multimedia system:

- ➔  ➔ Settings ➔ Assistance
- ➔ Active Lane Change Assist
- ▶ Activate or deactivate the function.

### Function of Active Emergency Stop Assist



If the system detects that the driver has not steered the vehicle for a considerable period of time or has removed their hands from the steering wheel, display **1** appears in the multifunction display. If the driver still does not steer the

vehicle, or gives no confirmation to the system, a warning tone sounds in addition to the visual warning message.

If the driver still does not respond to the warning, the **Beginning Emergency Stop** message appears in the multifunction display. If the driver still does not respond, Active Distance Assist DISTRONIC reduces the speed. The vehicle is decelerated in stages to a standstill.

Depending on the country, at speeds below 40 mph (60 km/h) the hazard warning lights switch on automatically.

When the vehicle is stationary, the following actions are carried out:

- The vehicle is secured with the electric parking brake.
- Active Distance Assist DISTRONIC is ended
- The vehicle is unlocked.
- If possible, an emergency call is placed to the Mercedes-Benz emergency call center

The driver can cancel the deceleration at any time by performing one of the following actions:

- Steering

- Braking or accelerating
- Deactivating Active Distance Assist DISTRONIC

### Function of Active Traffic Jam Assist

Active Traffic Jam Assist helps you when in traffic jams on multi-lane roads with separate roadways by automatically pulling away within up to 60 seconds and with moderate steering maneuvers. It orients itself using the vehicle in front and lane markings. Active Traffic Jam Assist automatically maintains a safe distance from the vehicle in front and vehicles cutting in.

Active Traffic Jam Assist requires you, as the driver, to keep your hands on the steering wheel at all times so that you are able to intervene at any time to correct the course of the vehicle and keep it in lane.

Observe the notes on driving systems and your responsibility; you may otherwise fail to recognize dangers (→ page 174).

Active Traffic Jam Assist activates automatically when all of the following conditions are met:

- You are in a traffic jam on a freeway or high-speed major road.
- Active Distance Assist DISTRONIC is activated and active (→ page 191).
- Active Brake Assist is available (→ page 180).
- Active Steering Assist is activated and active (→ page 197).
- Active Traffic Jam Assist is activated (→ page 200).
- You are traveling no faster than 35 mph (60 km/h).

The following symbol is displayed in the instrument cluster when the system is active:



### System limits

The system limitations of Active Distance Assist DISTRONIC and Active Steering Assist apply to Active Traffic Jam Assist (→ page 195).

### Activating/deactivating Active Traffic Jam Assist

Multimedia system:

→  → Settings → Quick Access



### Function of Hill Start Assist

Hill Start Assist holds the vehicle for a short time when pulling away on a hill under the following conditions:

- The transmission is in position **D** or **R**.
- The electric parking brake is released.

This gives you enough time to move your foot from the brake pedal to the accelerator pedal

and depress it before the vehicle begins to roll away.

**⚠ WARNING** Risk of accident and injury due to the vehicle rolling away

After a short time, Hill Start Assist no longer holds the vehicle.

- ▶ Swiftly move your foot from the brake pedal to the accelerator pedal. Do not leave the vehicle when it is being held by Hill Start Assist.

### HOLD function

#### HOLD function

The HOLD function holds the vehicle at a standstill without requiring you to depress the brake pedal, e.g. while waiting in traffic.

The HOLD function is only an aid. The responsibility for the vehicle safely standing still remains with the driver.

#### System limits

The HOLD function is only intended to provide assistance when driving and is not a sufficient

means of safeguarding the vehicle against rolling away when stationary.

- The incline must not be greater than 30%.

### Activating/deactivating the HOLD function

**⚠ WARNING** Risk of an accident due to the HOLD function being activated when you leave the vehicle

If the vehicle is only braked with the HOLD function it could, in the following situations, roll away:

- If there is a malfunction in the system or in the power supply.
- If the HOLD function is deactivated by depressing the accelerator pedal or brake pedal, e.g. by a vehicle occupant.

- ▶ Always secure the vehicle against rolling away before you leave it.

#### Requirements:

- The vehicle is stationary.

- The driver's door is closed or the seat belt on the driver's side is fastened.
- The engine is running or has been automatically switched off by the ECO start/stop function.
- The electric parking brake is released.
- Active Distance Assist DISTRONIC is deactivated.
- The transmission is in position **D**, **R** or **N**.

#### Activating the HOLD function

- ▶ Depress the brake pedal and after a short time quickly depress further until the **HOLD** display appears in the multifunction display.
- ▶ Release the brake pedal.

#### Deactivating the HOLD function

- ▶ Depress the accelerator pedal to pull away.
- or
- ▶ Depress the brake pedal until the **HOLD** display disappears from the multifunction display.

The HOLD function is deactivated in the following situations:

- Active Distance Assist DISTRONIC is activated.
- The transmission is switched to position **P**.
- The vehicle is secured with the electric parking brake.

In the following situations, the vehicle is held by transmission position **P** and/or by the electric parking brake:

- The seat belt is unfastened and the driver's door is opened.
- The vehicle is switched off.
- There is a malfunction in the system or the power supply is insufficient.

### AIRMATIC

#### Function of AIRMATIC

**Mercedes-AMG vehicles:** observe the notes in the Supplement. You could otherwise fail to recognize dangers.

AIRMATIC is an air suspension system with variable damping for improved driving comfort and vehicle dynamics. The all-round level control system ensures the best possible suspension and constant ground clearance, even with a laden vehicle. When driving at speed, the vehicle is lowered automatically to improve driving safety and to reduce fuel consumption. You also have the option of manually adjusting the vehicle level.

AIRMATIC is comprised of the following functions and components:

- Air suspension with automatic level control
- Speed-dependent lowering
- Manually selectable high level setting for greater ground clearance which can be adjusted using a level button
- ADS PLUS (Adaptive Damping System with constant adjustment of damping characteristics)

### Suspension setting and vehicle level per drive program

Drive program  and :

- The suspension setting is comfortable.
- The vehicle is set to the normal level.
- When driving at speeds above approximately 87 mph (140 km/h), the vehicle is lowered.
- When driving at speeds below approximately 25 mph (40 km/h), the vehicle is raised again.

Drive program :

- The suspension setting is firmer.
- The vehicle is lowered to sport level.

Drive program :

- The suspension setting is even firmer.
- The vehicle is lowered to Sport + level.

Drive program :

- The suspension setting is suitable for easily negotiable off-road terrain.
- The vehicle is set to off-road level +1 (raised level).

- When driving at speeds above approximately 50 mph (80 km/h), the vehicle is lowered.
- When driving at speeds below approximately 28 mph (45 km/h), the vehicle is raised.

Individual suspension settings can be called up in drive program  (→ page 159).

If the entry/exit level function is activated, the vehicle is set to the **Sport +** level to facilitate entering/exiting the vehicle. When driving at speeds above approx. 19 mph (30 km/h), the entry/exit level is deactivated and the vehicle is raised (→ page 204).

Differences between different vehicle levels compared to the normal level:

- **Car wash:** approx. +3.5 in (+90 mm) (→ page 297)
- **Raised level:** approx. +2.0 in (+50 mm)
- **Sport:** approx. -0.6 in (-15 mm)
- **Sport +:** approx. -1.0 in (-25 mm)

 Car wash level is +1.6 in (40 mm) above the maximum vehicle height (raised level). Driv-

ing into underground car parks at car wash level risks damaging the vehicle.

### Operation with a trailer or bicycle rack

If the electrical connection has been correctly established to the trailer or bicycle rack:

- Drive program : the vehicle adopts the normal level starting from a speed of 19 mph (30 km/h).
- All other drive programs: the vehicle remains at normal level irrespective of speed.

### System limits

AIRMATIC may not be available or have only limited availability in the following cases:

- The overheating protection has been activated due to frequent level changes within a short time. The  warning lamp appears in the multifunction display.  
After the cooling phase, the system is again available without restriction.

### Setting the vehicle level (vehicles with AIR-MATIC)

- ⚠ WARNING** Risk of accident because vehicle level is too high

If you drive at a higher vehicle level, the driving characteristics may be impaired due to the higher vehicle center of gravity.

The vehicle can drift outwards, for example, when steering or cornering.

- ▶ Always choose a vehicle level which is suited to the driving style and the road surface conditions.

- ⚠ WARNING** Risk of entrapment from vehicle lowering

When lowering the vehicle, people could become trapped if their limbs are between the vehicle body and the tires or underneath the vehicle.

- ▶ Make sure no one is underneath the vehicle or in the immediate vicinity of

the wheel arches when the vehicle is being lowered.

- ⚠ WARNING** Risk of becoming trapped due to the vehicle lowering

**Vehicles with AIRMATIC or level control:** when you unload luggage or leave the vehicle, the vehicle first rises slightly and then returns to the set level shortly afterwards.

You or anyone else in the vicinity of the wheel arches or the underbody could thus become trapped.

The vehicle can also be lowered after being locked.

- ▶ When leaving the vehicle, make sure that nobody is in the vicinity of the wheel arches or the underbody.

- ℹ NOTE** Damage due to vehicle lowering

Parts of the body could be damaged when the vehicle is lowered.

- ▶ Make sure that there are no obstacles such as curbs underneath or in the immediate vicinity of the body when the vehicle is being lowered.

**Mercedes-AMG vehicles:** observe the notes in the Supplement. You could otherwise fail to recognize dangers.

#### Requirements:

- The vehicle has been started.
- The vehicle is not moving faster than 40 mph (65 km/h).

### Raising the vehicle

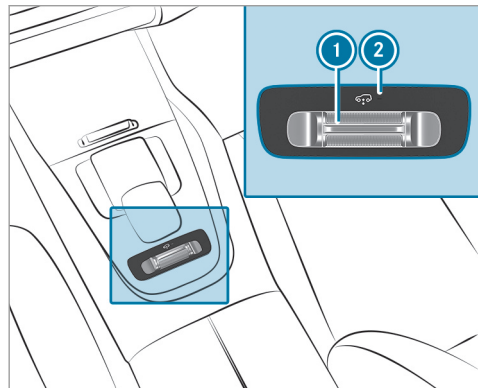

- ▶ Push rocker switch ① forwards. Indicator lamp ② flashes while the vehicle is being raised and lights up continuously when it has finished rising.

The vehicle is raised to off-road level +1.

Your selection is saved. The off-road level +1 set remains stored even after the ignition has been switched off.

The vehicle is lowered again in the following situations:

- When driving faster than 50 mph (80 km/h).
- When driving briefly between 40 mph (65 km/h) and 50 mph (80 km/h).
- After selecting a different drive program using the DYNAMIC SELECT switch.

In this case, the vehicle is adjusted to the height of the active drive program.

### Lowering the vehicle

- ▶ Pull rocker switch ①. Indicator lamp ② goes out when the lowering process is complete.

The vehicle is adjusted to the height of the active drive program.

### Operation with a trailer or bicycle rack

If the electrical connection has been correctly established to the trailer or bicycle rack:

- From approx. 18.7 mph (30 km/h): off-road level +1 can be selected, regardless of drive program.
- From approx. 18.7 mph (30 km/h): the vehicle is adjusted to normal level, regardless of drive program.

### Setting the entering/exiting level (AIRMATIC) Requirements:

- The engine is running.
- The vehicle is moving at speeds less than 20 mph (30 km/h).

Multimedia system:

- ▶ ▶ Settings
- ▶ Schnellzugriff (Quick access)

- ▶ Select **Lower When Getting In On**. The vehicle is lowered to low level -2 to facilitate entering and exiting.

The availability of this function depends on the vehicle equipment.



- i** Further information on AIRMATIC  
(→ page 201).

### Lowering and raising the rear of the vehicle

**⚠ WARNING** Risk of entrapment from vehicle lowering

When lowering the vehicle, people could become trapped if their limbs are between the vehicle body and the tires or underneath the vehicle.

- ▶ Make sure no one is underneath the vehicle or in the immediate vicinity of the wheel arches when the vehicle is being lowered.

#### Requirements:

- All vehicle doors are closed
- There is no trailer coupled
- There is no bicycle rack installed
- The battery is sufficiently charged; if necessary, start the engine

### Lowering the rear of the vehicle

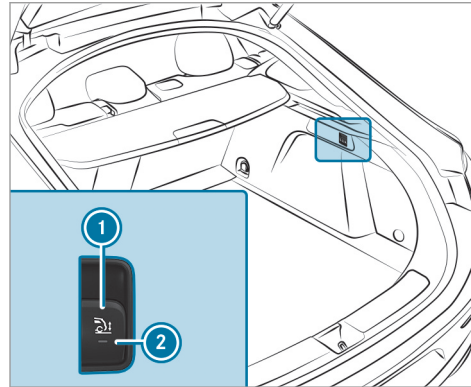

- ▶ Apply the electric parking brake.
- ▶ Shift the transmission to position **P** (→ page 161).
- ▶ Pull switch **1** in the right-hand cargo compartment trim briefly. Indicator lamp **2** flashes until the vehicle has been lowered.

The vehicle is lowered at the rear axle by approx. 1.5 in (40 mm). When the vehicle has been lowered, indicator lamp **2** remains lit.

When the rear of the vehicle has been completely lowered, indicator lamp **2** remains lit.

Lowering is interrupted in the following situations:

- A vehicle door is opened
  - Switch **1** is pulled again
  - The vehicle is being driven faster than 1.2 mph (2 km/h).
- i** The vehicle is automatically set to the level of the most recently selected drive program if you drive at speeds greater than 1.2 mph (2 km/h).

If indicator lamp **2** flashes twice and the rear of the vehicle does not lower:

- ▶ Make sure that the requirements are met.
- i** Lowering the rear of the vehicle allows the vehicle to be loaded more easily. Observe the notes on loading the vehicle when doing this (→ page 102).

### Raising the rear of the vehicle

▶ Check if the battery is sufficiently charged. If necessary, start the engine.

▶ Pull switch ① briefly.  
Indicator lamp ② goes out.

The vehicle will be raised to the currently selected level.

① The vehicle is automatically set to the level of the most recently selected drive program if you drive at speeds greater than 1.2 mph (2 km/h).

If the vehicle cannot be raised:

▶ Ensure that the battery is sufficiently charged; if necessary, start the engine.  
The raising process continues.

### E-ACTIVE BODY CONTROL

#### Function of E-ACTIVE BODY CONTROL

E-ACTIVE BODY CONTROL is an electrohydraulic suspension system with variable damping for improved driving comfort. The all-round level control system ensures the best possible suspension and constant ground clearance, even

with a laden vehicle. When driving at speed, the vehicle is lowered automatically to improve driving safety and to reduce fuel consumption. The suspension setting is adjusted depending on the road surface, vehicle load and the drive program selected.

The ROAD SURFACE SCAN function detects areas of unevenness in the road before you drive over them by means of a multifunction camera. This reduces chassis movements.

The damping is adjusted individually to each wheel and depends on the following factors:

- Driving style, e.g. sporty
- Road condition, e.g. bumps
- Drive program

E-ACTIVE BODY CONTROL is comprised of the following functions and components:

- **Vehicles with Driving Assistance Package:** ROAD SURFACE SCAN
- Curve inclination function CURVE
- Recovery mode
- Individual wheel control

- Air suspension with automatic level control
- Speed-dependent lowering to reduce fuel consumption
- Manual level adjustment
- ADS PLUS (Adaptive Damping System with constant adjustment of damping characteristics)
- DYNAMIC SELECT switch and level button

#### Suspension settings and vehicle level per drive program

Drive program **S**

- The suspension setting is firmer.
- The vehicle is set to Sport level.
- ROAD SURFACE SCAN is deactivated.
- The curve inclination function is deactivated.

Drive program **S+**

- The suspension setting is even firmer.
- The vehicle is set to Sport + level.
- ROAD SURFACE SCAN is deactivated.
- The curve inclination function is active.

Drive program 

- The suspension setting is comfortable.
- The vehicle is set to the normal level.
- When driving at speeds above approximately 87 mph (140 km/h), the vehicle is lowered.
- When driving at speeds below approximately 25 mph (40 km/h), the vehicle is raised.
- ROAD SURFACE SCAN is active.
- The curve inclination function is deactivated.

Drive program 

- The suspension setting is comfortable.
- The vehicle is set to the normal level.
- When driving at speeds above approximately 87 mph (140 km/h), the vehicle is lowered.
- When driving at speeds below approximately 25 mph (40 km/h), the vehicle is raised again.
- ROAD SURFACE SCAN is active.
- The curve inclination function is active.

Drive program 

- The suspension setting is comfortable.

- The vehicle is set to the normal level.
- When driving at speeds above approximately 87 mph (140 km/h), the vehicle is lowered.
- When driving at speeds below approximately 25 mph (40 km/h), the vehicle is raised again.
- ROAD SURFACE SCAN is deactivated.
- The curve inclination function is deactivated.

Drive program 

- The suspension setting is suitable for easily negotiable off-road terrain.
- The vehicle is set to off-road level +1.
- When driving at speeds above approximately 50 mph (80 km/h) the vehicle is lowered.
- When driving at speeds below approximately 28 mph (45 km/h), the vehicle is raised.
- ROAD SURFACE SCAN is deactivated.
- The curve inclination function is deactivated.
- Recovery mode and the individual wheel control function can be activated provided the necessary conditions are met.

Drive program 

- You can call up individual suspension settings here.

**Operation with a trailer or bicycle rack**

If the electrical connection has been correctly established to the trailer or bicycle rack:

- The curve inclination function is deactivated.
- Drive program : the vehicle adopts the normal level starting from a speed of 19 mph (30 km/h).
- All other drive programs: the vehicle remains at normal level irrespective of speed.

Level differences compared to the normal level

- **Car wash:** approx. +3.5 in (+90 mm) (→ page 297)
- **Raised level:** approx. +2.0 in (+50 mm)
- **Sport:** approx. -0.6 in (-15 mm)
- **Sport +:** approx. -1.0 in (-25 mm)

- Car wash level is +1.6 in (40 mm) above the maximum vehicle height (raised level). Driving into underground car parks at car wash level risks damaging the vehicle.

### Function of ROAD SURFACE SCAN

- This function is not available in all countries.

The ROAD SURFACE SCAN function monitors the road in front of your vehicle using multifunction camera (→ page 174). ROAD SURFACE SCAN detects unevenness in the road surface, e.g. bumps, before the vehicle drives over them. Chassis movements are reduced and driving comfort is increased.

ROAD SURFACE SCAN is automatically activated if the following conditions are met:

- The drive program **C** or **CV** is selected.
- The vehicle is set to the normal level.
- You are driving at a speed between 4 mph (7 km/h) and 112 mph (180 km/h).

### System limits

ROAD SURFACE SCAN can be impaired in the following situations or can stop functioning:

- If the road is insufficiently lit, e.g. at night.
- In snow, rain, fog, heavy spray, if there is glare, in direct sunlight or in greatly varying ambient light.
- If the windshield in the area of multifunction camera **1** is dirty, fogged up, damaged or covered.
- If the road surface has no optic structure or reflects light.
- If you are driving too close to the vehicle in front.
- If sections of the route have a very small radius of curvature.
- During abrupt driving maneuvers, e.g. heavy braking or sudden acceleration.

Observe the notes on cleaning the multifunction camera (→ page 299).

### Function of recovery mode

**⚠ WARNING** Risk of injury due to the vehicle moving up and down

During recovery mode, the vehicle moves up and down and can cause injuries.

- ▶ When activating recovery mode, make certain that no one is in the vicinity of the vehicle.

**! NOTE** Risk of damage due to the vehicle moving up and down

When free driving mode is activated, the vehicle moves up and down. Vehicle parts may be damaged if the underbody bottoms out.

- ▶ Make sure that there is sufficient ground clearance when rocking free mode is activated.

Recovery mode is a function of the suspension which can assist the driver on loose surfaces (e.g. sand, snow) when freeing a vehicle which has become stuck.

The vehicle body rocks in slow, vertical motions when recovery mode has been activated. This temporarily puts the wheels under greater load, which means they have increased traction and the vehicle is freed.

You can activate free driving mode via Off-road Assist (→ page 211).

### Function of individual wheel control

**⚠ WARNING** Risk of becoming trapped due to the vehicle lowering

The vehicle can be lowered when the individual wheel control function has been activated. Body parts could become trapped if they are between the vehicle body and the tires or underneath the vehicle.

- ▶ Make sure that nobody is under the vehicle or in the immediate vicinity of the wheel arches when individual wheel control is activated.

**!** **NOTE** Risk of damage due to the vehicle moving up and down

The vehicle can be lowered or raised on one or more wheels when the individual wheel control function has been activated. Vehicle parts could be damaged due to contact with objects.

- ▶ Make sure that the vehicle has sufficient room to move when the individual wheel control function has been activated.

Individual wheel control is a function of the suspension, which can be used to set the vehicle level for each wheel individually. This can help to improve alignment of the body when driving off-road.

You can activate individual wheel control via Off-road Assist (→ page 211).

### Adjusting the vehicle level (vehicles with E-ACTIVE BODY CONTROL)

**⚠ WARNING** Risk of accident because vehicle level is too high

Driving characteristics may be impaired.

The vehicle can drift outwards, for example, when steering or cornering.

- ▶ Choose a vehicle level which is suited to the driving style and the road surface conditions.

**⚠ WARNING** Risk of entrapment from vehicle lowering

When lowering the vehicle, people could become trapped if their limbs are between the vehicle body and the tires or underneath the vehicle.

- ▶ Make sure no one is underneath the vehicle or in the immediate vicinity of the wheel arches when the vehicle is being lowered.

**▲ WARNING** Risk of becoming trapped due to the vehicle lowering

**Vehicles with AIRMATIC or level control:** when you unload luggage or leave the vehicle, the vehicle first rises slightly and then returns to the set level shortly afterwards.

You or anyone else in the vicinity of the wheel arches or the underbody could thus become trapped.

The vehicle can also be lowered after being locked.

- ▶ When leaving the vehicle, make sure that nobody is in the vicinity of the wheel arches or the underbody.

**Requirements:**

- The vehicle has been started.
- The vehicle is being driven no faster than 40 mph (65 km/h).

**Raising the vehicle**

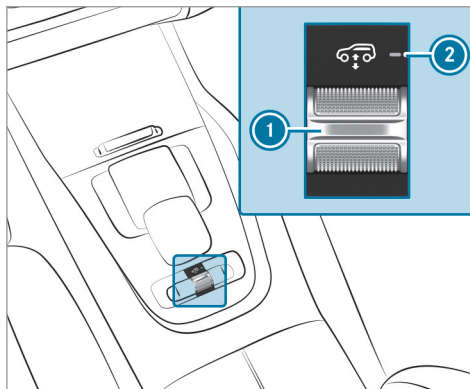

- ▶ Push rocker switch ① forwards. Indicator lamp ② flashes while the vehicle is being raised and lights up continuously when it has finished rising.

The vehicle is raised to off-road level +1.

Your selection is saved. The off-road level +1 set remains stored even after the ignition has been switched off.

The vehicle is lowered again in the following situations:

- When driving faster than 50 mph (80 km/h).
- When driving briefly between 40 mph (65 km/h) and 50 mph (80 km/h).
- After selecting a different drive program using the DYNAMIC SELECT switch.

In this case, the vehicle is adjusted to the height of the active drive program.

**Lowering the vehicle**

- ▶ Pull rocker switch ①. Indicator lamp ② goes out when the lowering process is complete.

The vehicle is adjusted to the height of the active drive program.

**Operation with a trailer or bicycle rack**

If the electrical connection has been correctly established to the trailer or bicycle rack:

- From approx. 18.7 mph (30 km/h): off-road level +1 can be selected, regardless of drive program.
- From approx. 18.7 mph (30 km/h): the vehicle is adjusted to normal level, regardless of drive program.

### Setting Off-road Assist

#### Requirements:

- the vehicle is stationary
- the vehicle is set to off-road level 1 or 2
- the Off-road or Off-road Plus (only vehicles with Off-road package) drive program has been selected
- the ignition is switched on
- all doors and the hood are closed
- the transmission is not engaged in position **P**
- there is no trailer coupled
- the vehicle is outdoors

- the detected lateral inclination of the vehicle must not exceed approx. 15°
- the system is within its operating temperature
- the on-board voltage is sufficiently high

Multimedia system:

→  ▶ Settings ▶ Assistance  
▶▶ Offroad Assistant

### Recovery mode

Recovery mode assists the driver when pulling away on rough terrain, such as sand or snow.

- ▶ Select **Recovery Mode**.
- ▶ Select **Start**.  
Recovery mode is activated.
- ▶ Select **Stop** to stop recovery mode.

Recovery mode is automatically deactivated in the following situations:

- you are actually traveling faster than 9 mph (15 km/h)
- after a running time of 30 seconds

- it is detected that an object has hit the underbody of the vehicle hard
- not all conditions are met

 Further information on recovery mode (→ page 208).

### Individual wheel control

Individual wheel control enables the vehicle level to be set separately for each wheel.

- ▶ Select **Individual Wheel Ctrl..**
- ▶ Set the vehicle level for the desired wheel.

 You can also use the touch display to set the level for two or more wheels at the same time.

- ▶ Select **Reset** to set all wheels to the default setting.

Individual wheel control is automatically deactivated in the following situations:

- you are traveling faster than 9 mph (15 km/h)
- it is detected that an object has hit the underbody of the vehicle hard

## 212 Driving and parking

- not all conditions are met
- ❗ Further information on individual wheel control (→ page 209).

### Parking Assist PARKTRONIC

#### Function of Parking Assist PARKTRONIC

Parking Assist PARKTRONIC is an electronic parking assistance system with ultrasound. It monitors the area around your vehicle using multiple sensors on the front bumper and on the rear bumper. Parking Assist PARKTRONIC shows you the distance between your vehicle and a detected obstacle visually and audibly.

Parking Assist PARKTRONIC is only an aid. It is not a substitute for your attention to the surroundings. The responsibility for safe maneuvering and parking remains with you. Make sure that there are no persons, animals or objects in the maneuvering area while maneuvering and parking in/exiting parking spaces.

In the standard setting, an intermittent warning tone sounds from a distance of approximately 1.0 ft (0.3 m) to an obstacle in front and approx-

imately 3.3 ft (1.0 m) to an obstacle behind. A continuous warning tone sounds from a distance of approximately 0.7 ft (0.2 m). Using the **Warn Early All Around** setting in the multimedia system, the warning tones for front and side impact protection can be set to sound at a greater distance of approximately 3.3 ft (1.0 m) in front and 2.0 ft (0.6 m) on the sides (→ page 216).

- ❗ The **Warn Early All Around** setting is always active at the rear of the vehicle.

If Parking Assist PARKTRONIC is deactivated, Active Parking Assist is unavailable.

### Parking Assist PARKTRONIC display in the multimedia system

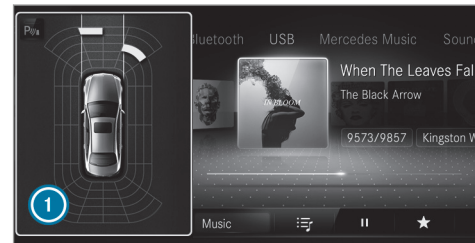

Vehicles with Active Parking Assist without a surround view camera



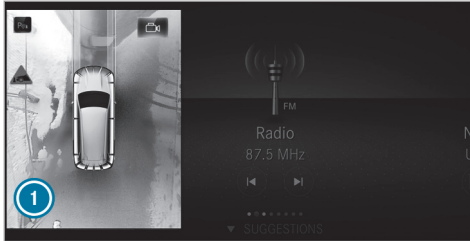

Vehicles with Active Parking Assist and a surround view camera

If Active Parking Assist is deactivated and an obstacle is detected in the path of the vehicle, a pop-up window for Parking Assist PARKTRONIC ① appears in the multimedia system at speeds below 6 mph (10 km/h).

The color of the individual segments of the warning display is based on the distance to the detected obstacle:

- **Yellow segments:** obstacles at a distance between approx. 2.0 ft (0.6 m) and 3.3 ft (1.0 m)

- **Orange segments:** obstacles at a distance between approx. 1.0 ft (0.3 m) and 2.0 ft (0.6 m)
- **Red segments:** obstacles at a very short distance of approx. 1.0 ft (0.3 m) or less

#### Display of Parking Assist PARKTRONIC in the Head-up Display

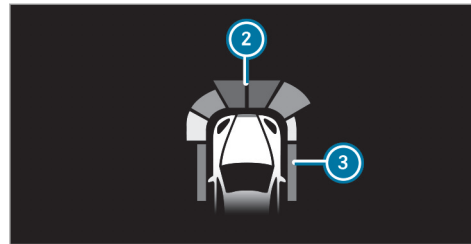

Optionally, obstacles detected by Parking Assist PARKTRONIC from a distance of approximately 3.3 ft (1.0 m) in front ② and 2.0 ft (0.6 m) on the sides ③ can also be displayed in the Head-up Display.

#### System limits

Parking Assist PARKTRONIC does not necessarily take into account the following obstacles:

- Obstacles below the detection range, e.g. persons, animals or objects.
- Obstacles above the detection range, e.g. overhanging loads, overhangs or loading ramps of trucks.

The sensors must be free of dirt, ice and slush. Otherwise, they may not function correctly. Clean the sensors regularly, especially after driving off-road, taking care not to scratch or damage them.

**Vehicles with trailer hitch:** Parking Assist PARKTRONIC is deactivated for the rear zone when you establish an electrical connection between your vehicle and a trailer.

### Problems with Parking Assist PARKTRONIC

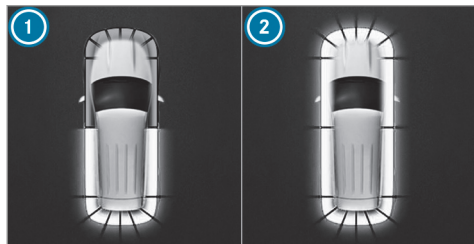

Example: vehicles with surround view camera

When rear segments ① or all-round segments ② light up red and the  symbol appears in the multifunction display, Parking Assist PARKTRONIC may have been deactivated due to signal interference. Start the vehicle again and check if Parking Assist PARKTRONIC is working at a different location.

If a warning tone also sounds for approximately two seconds every time the vehicle is started, it may be due to one of the following causes:

- **The sensors are dirty:** clean the sensors and observe the notes on care of vehicle parts (→ page 299).
- **Parking Assist PARKTRONIC has been deactivated due to a malfunction:** restart the vehicle. If the problem persists, consult a qualified specialist workshop.

#### Function of the passive side impact protection

Passive side impact protection is an additional Parking Assist PARKTRONIC function which warns the driver about obstacles at the side of the vehicle. A warning is issued when obstacles are detected between the front and rear detection range. In order for an object on the side to be detected, the sensors in the front and rear bumper must first detect the object while you are driving past it.

During the parking procedure or when maneuvering, objects are detected as the vehicle drives past. If you steer in the direction of a detected

obstacle and there is a risk of a lateral collision, a warning is issued and the segments light up in color in the display.

The segment color changes depending on the distance to the detected obstacle:

- **Yellow:** approximately 1.0 - 2.0 ft (30 - 60 cm)
- **Red:** less than approximately 1.0 ft (30 cm)

In order for lateral front or rear segments to be displayed, the vehicle must first travel a distance of at least half of the vehicle length. Once the vehicle has traveled the length of the vehicle, all of the lateral front and rear segments can be displayed.

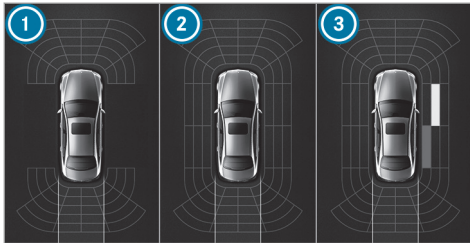

Parking Assist PARKTRONIC display: vehicles without a surround view camera

- ① Operational front and rear
- ② Operational front, rear and sides
- ③ Obstacle detected at the front right (yellow) and rear (red)

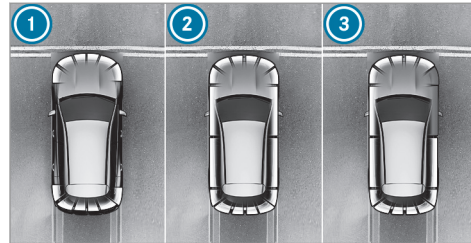

Parking Assist PARKTRONIC display: vehicles with a surround view camera

- ① Operational front and rear
- ② Operational front, rear and sides
- ③ Obstacles detected at the front right (red)

Saved obstacles on the sides are deleted in the following situations, for example:

- You park the vehicle and switch off the ignition.
- You open the doors.

After the engine is restarted, obstacles on the sides must be detected again before a new warning can be issued.

### System limits

The system limits for Parking Assist PARKTRONIC apply to passive side impact protection.

The following objects are not detected, for example:

- Pedestrians who approach the vehicle from the side
- Objects placed next to the vehicle



### Activating/deactivating Parking Assist PARKTRONIC

**!** **NOTE** Risk of an accident from objects at close range

Parking Assist PARKTRONIC may not detect certain objects at close range.

► When parking or maneuvering the vehicle, pay particular attention to any objects which are above or below the sensors, e.g. flower pots or drawbars. The vehicle or other objects could otherwise be damaged.

**Requirements:**

- The camera menu is open.
  - Or: Active Parking Assist is active.
  - Or: the PARKTRONIC pop-up window appears.
- ⓘ Make sure that there are no persons, animals or objects in the maneuvering area while maneuvering and parking in/exiting parking spaces.
- ▶ Tap  in the media display.
- ⓘ If the  symbol is shown in the multifunction display, Parking Assist PARKTRONIC is not active. Parking Assist PARKTRONIC is automatically activated when the vehicle is started.

Alternatively, Parking Assist PARKTRONIC can be activated or deactivated in the quick access menu.

**Adjusting the warning tones of Parking Assist PARKTRONIC**

Multimedia system:

- ▶  ▶ Settings ▶ Assistance ▶ Camera & Parking

**Adjusting the volume of the warning tones**

- ▶ Select **Warning Tone Volume**.
- ▶ Set a value.

**Adjusting the pitch of the warning tones**

- ▶ Select **Warning Tone Pitch**.
- ▶ Set a value.

**Specifying the starting point for the warning tones**

You can specify whether the Parking Assist PARKTRONIC warning tones should commence when the vehicle is further away from an obstacle.

- ▶ Select **Warn Early All Around**.
- ▶ Activate or deactivate the function.

**Activating/deactivating audio fadeout**

You can specify whether the volume of a media source in the multimedia system is to be reduced when Parking Assist PARKTRONIC sounds a warning tone.

- ▶ Select **Audio Fadeout During Warning Tones**.
- ▶ Activate or deactivate the function.

**Reversing camera**

**Function of the rear view camera**

When you engage reverse gear, the image from the rear view camera is shown in the media display. Dynamic guide lines show the path the vehicle will take with the current steering angle. This helps you to orient yourself and to avoid obstacles when backing up.

The rear view camera is only an aid. It is not a substitute for your attention to the surroundings. The responsibility for safe maneuvering and parking remains with you. Make sure that there are no persons, animals or objects etc., in the maneuvering area while maneuvering and parking.

**i** You can open the cover of the rear view camera manually (→ page 223).

The guide lines in the media display show the distances to your vehicle. The distances displayed only apply to road level.

Depending on the vehicle equipment, you can select from the following views:

- Normal view
- Wide-angle view
- Trailer view

The area behind the vehicle is displayed as a mirror image, as in the inside rearview mirror.

#### Vehicles without Active Parking Assist

The following camera views are available in the multimedia system:

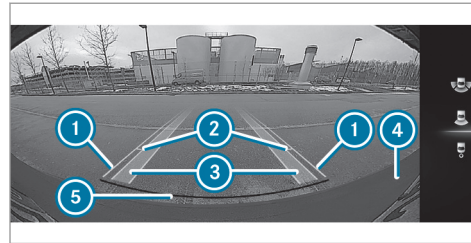

#### Normal view

- ① Yellow guide line, vehicle width (driven surface) depending on the current steering angle (dynamic)
- ② Yellow guide line at a distance of approximately 3.3 ft (1.0 m) from the rear area
- ③ Yellow lanes marking the course the tires will take with the current steering angle (dynamic)
- ④ Bumper
- ⑤ Red guide line at a distance of approximately 1.0 in (0.3 m) from the rear area

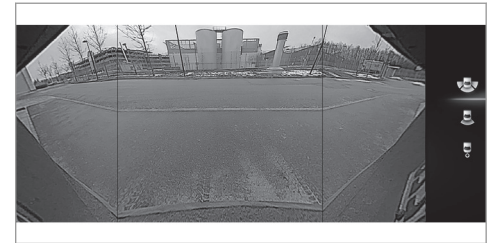

#### Wide-angle view

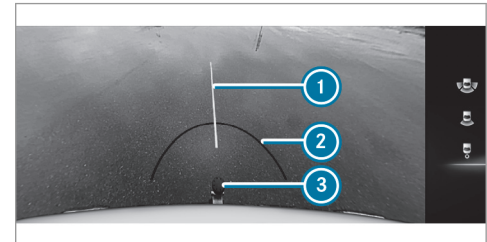

#### Trailer view (vehicles with a trailer hitch)

- ① Yellow guide line, locating aid

## 218 Driving and parking

- ② Red guide line at a distance of approximately 1.0 in (0.3 m) from the ball head of the trailer hitch
- ③ Ball head of the trailer hitch

### Vehicles with Active Parking Assist

The following camera views are available in the multimedia system:

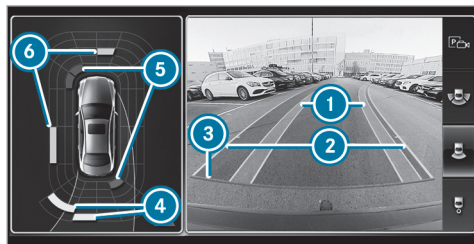

Normal view

- ① Yellow lanes marking the course the tires will take with the current steering angle (dynamic)

- ② Yellow guide line, vehicle width (driven surface) depending on the current steering angle (dynamic)
- ③ Red guide line at a distance of approximately 1.0 in (0.3 m) from the rear area
- ④ Yellow warning indicator of Parking Assist PARKTRONIC: obstacles at a distance between approximately 2.0 ft (0.6 m) and 3.3 ft (1.0 m)
- ⑤ Red warning display of Parking Assist PARKTRONIC: obstacles are very close (approximately 1.0 ft (0.3 m) or less)
- ⑥ Orange warning display of Parking Assist PARKTRONIC: obstacles are a medium distance away (between approximately 1.0 ft (0.3 m) and 2.0 ft (0.6 m))



Wide-angle view

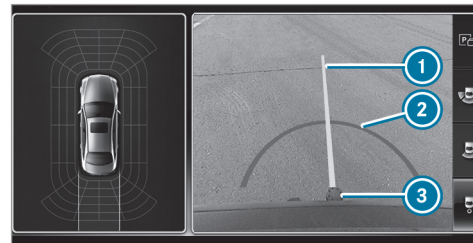

Trailer view (vehicles with a trailer hitch)

- ① Yellow guide line, locating aid

- ② Red guide line at a distance of approximately 1.0 in (0.3 m) from the ball head of the trailer hitch
- ③ Ball head of the trailer hitch

### System failure

If the rear view camera is not operational, the following display appears in the multimedia system.



### System limits

The rear view camera will not function or will only partially function in the following situations:

- The tailgate is open.
- There is heavy rain, snow or fog.
- The ambient light conditions are poor, e.g. at night.
- Cameras, or vehicle components in which the cameras are installed, are damaged, dirty

or covered. Observe the information on vehicle sensors and cameras (→ page 174).

- ① Do not use the rear view camera in these types of situation. You could otherwise injure others or collide with objects when parking the vehicle.

For technical reasons, the standard height of the vehicle may be altered if the vehicle is carrying a heavy load and can result in inaccuracies in the guide lines and in the display of the generated images.

- ① The contrast of the display may be impaired by direct sunlight or by other light sources, e.g. when driving out of a garage. In this case, pay particular attention.
- ① Have the display repaired or replaced if, for example, pixel errors considerably restrict its use.

### 360° camera

#### Function of the surround view camera

The surround view camera is a system that consists of four cameras. The cameras cover the

immediate vehicle surroundings. The system assists you, e.g. when parking or at exits with reduced visibility.

The views of the surround view camera are always available when driving forwards up to a speed of approx. 10 mph (16 km/h) and when backing up.

The surround view camera is only an aid and may show a distorted view of obstacles, show them incorrectly or not show them at all. It is not a substitute for your attention to the surroundings. The responsibility for safe maneuvering and parking remains with you. Make sure that there are no persons, animals or objects etc., in the maneuvering area while maneuvering and parking.

The system evaluates images from the following cameras:

- Rear view camera
- Front camera
- Two side cameras in the outside mirrors

- ① You can open the cover of the rear view camera manually (→ page 223).

### Views of the surround view camera

You can select from different views:

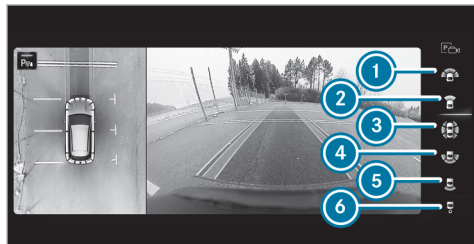

- 1 Wide-angle view, front
- 2 Top view with image from the front camera
- 3 Top view with images from the side cameras in the outside mirrors
- 4 Wide-angle view, rear
- 5 Top view with image from the rear view camera
- 6 Top view with trailer view (vehicles with a trailer hitch)

### Top view

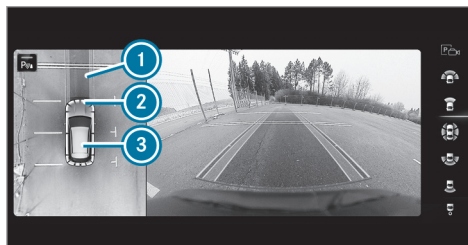

- 1 Lane indicating the route the vehicle will take at the current steering wheel angle
- 2 Warning display of Parking Assist PARKTRONIC
- 3 Your vehicle from above

The color of the individual segments of warning display 2 is based on the distance to the detected obstacle:

- **Orange segments:** obstacles at a distance between approx. 1.0 ft (0.3 m) and 2.0 ft (0.6 m)
  - **Red segments:** obstacles at a very short distance of approx. 1.0 ft (0.3 m) or less
- When Parking Assist PARKTRONIC is operational and no object is detected, the segments of the warning display are shown in gray.
- **Yellow segments:** obstacles at a distance between approx. 2.0 ft (0.6 m) and 3.3 ft (1.0 m)



## Guide lines

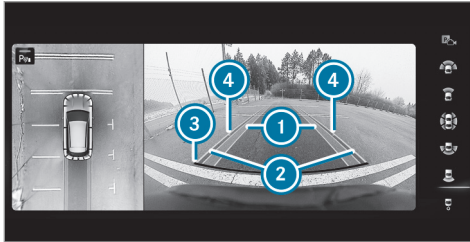

- ① Yellow lane marking the course the tires will take at the current steering wheel angle (dynamic)
- ② Yellow guide line, vehicle width (driven surface) depending on the current steering wheel angle (dynamic)
- ③ Red guide line at a distance of approximately 1.0 in (0.3 m) from the rear area
- ④ Mark at a distance of approx. 3.3 ft (1.0 m)
- i When Active Parking Assist is active, lane markings ① are displayed in green.

The guide lines in the media display show the distances to your vehicle. The distances apply to road level. In trailer mode, the guide lines are shown at the level of the trailer hitch.

### Trailer view (vehicles with a trailer hitch)

If you select trailer view and no trailer is coupled to the vehicle, the following display appears:

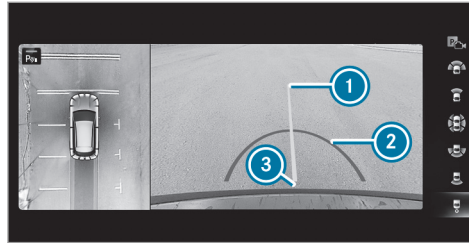

- ① Yellow guide line, locating aid
- ② Red guide line at a distance of approximately 1.0 in (0.3 m) from the ball head of the trailer hitch
- ③ Ball head of the trailer hitch



When the electrical connection is established between the vehicle and the trailer, the display changes to the side camera view.

This view supports maneuvering procedures with a trailer.

### Side view of the mirror cameras

The sides of the vehicle can be seen in this view.

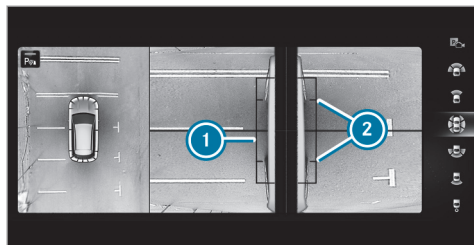

- ① Guide line of external vehicle dimensions with outside mirrors folded out
- ② Marker of the wheel contact points

### System failure

If the system is not ready for operation, the following message appears in the media display:



### System limits

The surround view camera will not function or will only partially function in the following situations:

- The doors are open.
  - The outside mirrors are folded in.
  - The tailgate is open.
  - There is heavy rain, snow or fog.
  - The ambient light conditions are poor, e.g. at night.
  - Cameras, or vehicle components in which the cameras are installed, are damaged, dirty or covered. Observe the information on vehicle sensors and cameras (→ page 174).
- ① Do not use the surround view camera under such circumstances. You could otherwise injure others or collide with objects when parking the vehicle.

For technical reasons, the standard height of the vehicle may be altered if the vehicle is carrying a heavy load and can result in inaccuracies in the guide lines and in the display of the generated images.

- ① The contrast of the display may be impaired by abrupt, direct sunlight or by other light sources, e.g. when driving out of a garage. In this case, pay particular attention.
- ① Have the display repaired or replaced if, for example, pixel errors considerably restrict its use.

See the notes on cleaning the surround view camera (→ page 299).

### Selecting a view for the surround view camera

- ▶ Shift to reverse gear.
- ▶ Select the desired view in the multimedia system (→ page 219).
- ▶ If, after shifting to reverse gear, the image of the rear view camera is not shown: switch off the ignition, press and hold the  button, switch on the ignition and engage reverse gear again.

### Opening the camera cover of the rear view camera

Multimedia system:

→  → Settings → Assistance  
→ Camera & Parking

▶ Select **Open Camera Cover**.

 The camera cover closes automatically after some time or after an ignition cycle.

### Active Parking Assist

#### Function of Active Parking Assist

Active Parking Assist is an electronic parking assistance system that automatically searches for and measures parking spaces on both sides of the vehicle when traveling forwards up to approx. 22 mph (35 km/h).

Active Parking Assist provides assistance when changing gear, accelerating, braking and steering the vehicle.

If all requirements are met, the  display appears in the multifunction display. The system then independently locates and measures paral-

lel and perpendicular parking spaces on both sides of the vehicle.

When Active Parking Assist has detected parking spaces, the  display appears in the multifunction display. The arrows show on which side of the road detected parking spaces are located. They are then shown in the media display. The parking space and, if necessary, the parking direction can be selected as desired. Active Parking Assist calculates a suitable vehicle path, switches on the turn signal indicator and assists you in parking and exiting the parking space.

Active Parking Assist is only an aid. It is not a substitute for your attention to the surroundings. The responsibility for safe maneuvering and parking remains with you. Make sure that no persons, animals or objects etc. are in the maneuvering range.

If one of the following actions is carried out, Active Parking Assist is canceled:

- Parking Assist PARKTRONIC is deactivated.
- You begin steering.
- You apply the parking brake.

- You engage transmission position .
- ESP® intervenes.
- You open the doors or the tailgate while driving.

#### System limits

Objects located above or below the detection range of the sensors, e.g. overhanging loads, tail sections or loading ramps of goods vehicles, or the borders of parking spaces, are not detected during measurement of the parking space. These are also then not taken into account when calculating the parking procedure. In some circumstances, Active Parking Assist may therefore guide you into the parking space incorrectly.

 **WARNING** Risk of accident due to objects located above or below the detection range of Active Parking Assist

If there are objects above or below the detection range, the following situations may arise:

- Active Parking Assist may steer too early.

## 224 Driving and parking

- The vehicle may not stop in front of these objects.

This could cause a collision.

- ▶ In these situations, do not use Active Parking Assist.

Extreme environmental conditions, such as snowfall or heavy rain, may lead to a parking space being measured inaccurately. Parking spaces that are partially occupied by trailer drawbars might not be identified as such or be measured incorrectly. Only use Active Parking Assist on level, high-grip ground.

Do not use Active Parking Assist in the following situations:

- In extreme weather conditions such as ice, packed snow or in heavy rain.
- When transporting a load that protrudes beyond the vehicle.
- If the parking space is on a steep downhill or uphill gradient.
- When snow chains are installed.
- When a trailer or bicycle rack is attached.

- Directly after a tire change or when spare tires are installed.
- If the tire pressure is too low or too high.
- If the suspension is out of alignment, e.g. after bottoming out on a curb.
- On steep inclines of more than approx. 15%.

Active Parking Assist may also display parking spaces that are not suitable for parking, such as, e.g.:

- Parking spaces where parking is prohibited.
- Parking spaces on unsuitable surfaces.

### Parking with Active Parking Assist

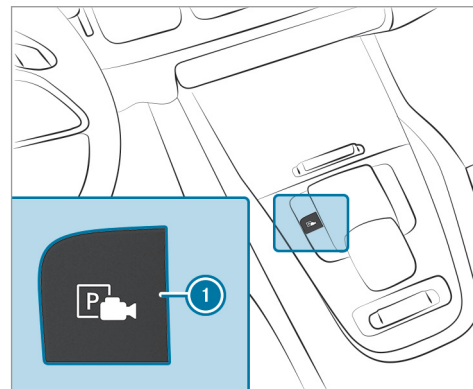

- ▶ Press button ①.

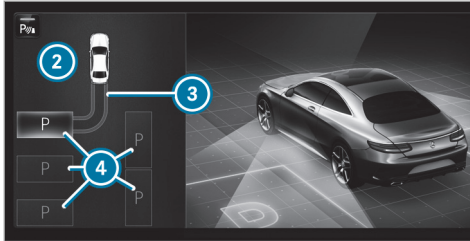

The media display shows the view of Active Parking Assist. Area ② displays detected parking spaces ④ and vehicle path ③.

- ① Vehicle path ③ shown on the media display may differ from the actual vehicle path.
- ▶ If a parking space is displayed: stop the vehicle.
- ▶ Select desired parking space ④ and confirm.
- ▶ If necessary, select the parking direction: forwards or reverse, and confirm. Vehicle path ③ is shown, depending on selected parking space ④ and the parking direction.

- ① The turn signal indicator is switched on automatically when the parking procedure begins.

You are responsible for selecting the turn signal indicator in accordance with the traffic conditions. If necessary, select the turn signal indicator accordingly.

**⚠ WARNING** Risk of accident due to vehicle swinging out while parking or pulling out of a parking space

While parking or exiting a parking space, the vehicle swings out and can drive onto areas of the oncoming lane.

This could cause you to collide with objects or other road users.

- ▶ Pay attention to objects and other road users.
- ▶ Where necessary, stop the vehicle or cancel the parking procedure with Active Parking Assist.

- ▶ If, for example, the **Please Engage Reverse Gear** message appears in the media display:

select the corresponding transmission position.

The vehicle drives into the selected parking space.

- ① During the parking procedure with Active Parking Assist, the lane markings are displayed in green in the camera image.

On completion of the parking procedure, the  **Parking Assist Finished, Take Control of Vehicle** display message appears. Further maneuvering may still be necessary.

- ▶ After completion of the parking procedure, safeguard the vehicle against rolling away. When required by legal requirements or local conditions: turn the wheels towards the curb.
- ① You can stop the vehicle and change the transmission position during the parking procedure. The system then calculates a new vehicle path. If no new vehicle path is available, the system can change the transmission position again or cancel the parking procedure.

### Exiting a parking space with Active Parking Assist

#### Requirements:

- The vehicle has been parked with Active Parking Assist.

Please note that you are responsible for the vehicle and surroundings during the entire parking procedure.

- ▶ Start the vehicle.

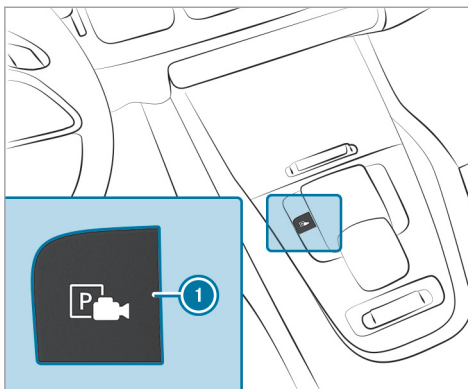

- ▶ Press button ①. The media display shows the view of Active Parking Assist.

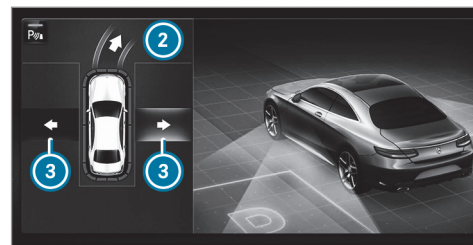

- ▶ If the vehicle has been parked perpendicular to the direction of travel: in area ②, select direction of travel ③ **Left** or **Right**.

**i** The vehicle path shown on the media display may differ from the actual vehicle path.

- ▶ Confirm direction of exit ③ to drive out of the parking space.

**i** The turn signal indicator is switched on automatically when the exiting procedure begins.

You are responsible for selecting the turn signal indicator in accordance with the traffic conditions. If necessary, select the turn signal indicator accordingly.

**⚠ WARNING** Risk of accident due to vehicle swinging out while parking or pulling out of a parking space

While parking or exiting a parking space, the vehicle swings out and can drive onto areas of the oncoming lane.

This could cause you to collide with objects or other road users.

- ▶ Pay attention to objects and other road users.
- ▶ Where necessary, stop the vehicle or cancel the parking procedure with Active Parking Assist.

- ▶ If, for example, the **Please Engage Forward Gear** message appears in the media display: select the corresponding transmission position. The vehicle moves out of the parking space. The turn signal indicator is switched off automatically.

After the parking space has been exited, a warning tone and the  **Parking Assist Finished**,

**Take Control of Vehicle** message prompt you to take control of the vehicle.

The vehicle is not automatically braked and can roll away. You have to accelerate, brake, steer and change gear yourself again.

## ATTENTION ASSIST

### Function of ATTENTION ASSIST

ATTENTION ASSIST assists you on long, monotonous journeys, e.g. on highways and trunk roads. If ATTENTION ASSIST detects indicators of fatigue or increasing lapses in concentration on the part of the driver, it suggests taking a break.

ATTENTION ASSIST is only an aid. It cannot always detect fatigue or lapses in concentration in time. The system is not a substitute for a well-rested and attentive driver. On long journeys, take regular breaks in good time that allow for adequate recuperation.

You can choose between two settings:

- **Standard:** normal system sensitivity.
- **Sensitive:** higher system sensitivity. The driver is warned earlier and the attention

level detected by ATTENTION ASSIST is adapted accordingly.

If drowsiness or increasing lapses in concentration are detected, the **ATTENTION ASSIST: Take a Break!** warning appears in the Instrument Display. You can acknowledge the message and take a break where necessary. If you do not take a break and ATTENTION ASSIST continues to detect increasing lapses in concentration, you will be warned again after a minimum of 15 minutes.



You can have the following status information for ATTENTION ASSIST displayed in the assistance menu of the on-board computer:

- The length of the journey since the last break.
- The attention level determined by ATTENTION ASSIST:
  - the fuller the circle, the higher the attentional level determined
  - as your attention wanes, the circle in the center of the display becomes smaller

If ATTENTION ASSIST is unable to calculate the attention level and cannot issue a warning, the **System Suspended** message appears.

If a warning is given in the Instrument Display, the multimedia system offers to search for a rest area. You can select a rest area and start navigation to this rest area. This function can be activated and deactivated in the multimedia system.

If ATTENTION ASSIST is deactivated, the  symbol appears in the assistance graphic in the Instrument Display when the engine is running. ATTENTION ASSIST is activated automatically

when the engine is re-started. The last selected sensitivity level remains stored.

### System limits

ATTENTION ASSIST is active in the 37 mph (60 km/h) to 124 mph (200 km/h) speed range.

The functionality of ATTENTION ASSIST is restricted, and warnings may be delayed or not occur at all in the following situations:

- If you have been driving for less than approximately 30 minutes.
- If the road condition is poor (uneven road surface or potholes).
- If there is a strong side wind.
- If you adopt a sporty driving style (high cornering speeds or high rates of acceleration).
- If the Steering Assist function of Active Distance Assist DISTRONIC is active.
- If the time has been set incorrectly.
- If you change lanes and vary your speed frequently in active driving situations.

The ATTENTION ASSIST tiredness or alertness assessment is deleted and restarted when continuing the journey in the following situations:

- If you switch off the engine.
- If you unfasten your seat belt and open the driver's door (e.g. changing drivers or taking a break).

### Setting ATTENTION ASSIST

Multimedia system:

  **» Settings » Assistance**  
**» Attention Assist**

### Setting options

- ▶ Select **Standard**, **Sensitive** or **Off**.

### Suggesting a rest area

- ▶ Select **Suggest Rest Area**.
- ▶ Activate or deactivate the function. If ATTENTION ASSIST detects fatigue or increasing lack of attention, it suggests a rest area in the vicinity.
- ▶ Select the suggested rest area. You are guided to the selected rest area.



## Traffic Sign Assist

### Function of Traffic Sign Assist

Traffic Sign Assist detects traffic signs with the multifunction camera (→ page 174). It assists you by displaying detected speed limits and overtaking restrictions in the instrument cluster and optionally in the Head-up Display or central display.

Observe the notes on driving systems and your responsibility; you may otherwise fail to recognize dangers (→ page 174).

Since Traffic Sign Assist also uses the data stored in the navigation system, it can update the display in the following situations without detecting traffic signs:

- When the vehicle changes roads, e.g. freeway entry or exit road.
- When a village or city boundary which is stored in the digital map is passed.

The camera also detects traffic signs with a restriction indicated by an additional sign (e.g. when wet).

### Warning when the maximum permissible speed is exceeded

The system can warn you if you unintentionally exceed the maximum permissible speed. To do this, you can specify in the multimedia system by how much the maximum permissible speed can be exceeded before a warning is issued. You can specify whether the warning is to be just a visual warning or an acoustic one as well.

### Display in the Instrument Display

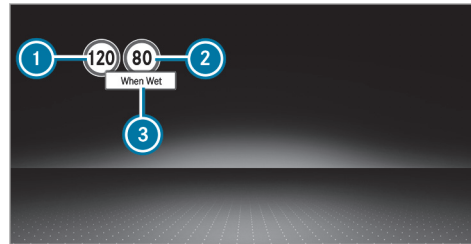

Instrument Display in the Widescreen Cockpit

- 1 Permissible speed
- 2 Permissible speed when there is a restriction
- 3 Additional sign with restriction

- i Vehicles with a standard Instrument Display:** a + symbol next to a traffic sign in the Instrument Display indicates that additional traffic signs have been detected. These can also be displayed in the media display and optionally in the Head-up Display.

If Traffic Sign Assist cannot determine the current maximum permissible speed (e.g. due to missing signs), the following display appears in the Instrument Display:



This is displayed continuously if the vehicle is in a country where Traffic Sign Assist is not supported. Traffic Sign Assist is not available in all countries.

- i** Also observe the information on display messages in Traffic Sign Assist (→ page 368).

### System limits

The system may be impaired or may not function in the following situations:

- If there is poor visibility, e.g. due to insufficient illumination of the road, if there are highly variable shade conditions or in rain, snow, fog or heavy spray.
- If there is glare, e.g. from oncoming traffic, direct sunlight or reflections.
- If the windshield in the area of the multifunction camera is dirty, or if the camera is fogged up, damaged or covered.
- If the traffic signs are hard to detect, e.g. due to dirt or snow, because they are covered, or due to insufficient lighting.
- If the information in the navigation system's digital map is incorrect or out-of-date.
- If the signs are ambiguous, e.g. traffic signs on construction sites or in adjacent lanes.
- If you turn sharply, when passing traffic signs outside the camera's field of vision.

### Setting Traffic Sign Assist Requirements:

- **Only vehicles with Driving Assistance Package:**

Active Distance Assist DISTRONIC must be activated for the automatic adoption of speed limits.

Multimedia system:

→  » Settings » Assistance  
» Traffic Sign Assist

### Activating or deactivating automatic adoption of speed limits (only vehicles with Driving Assistance Package)

- ▶ Select **Limit Adoption**.
- ▶ Activate or deactivate the function.  
The speed limits detected by Traffic Sign Assist are automatically adopted by Active Distance Assist DISTRONIC.
- ⓘ If one of the following systems is activated, the detected speed can be manually adopted as the speed limit:
  - Active Distance Assist DISTRONIC
  - Cruise control
  - Variable limiter

Further information (→ page 191).

### Displaying detected traffic signs in the media display

- ▶ Select **Display in Central Display**.
- ▶ Activate or deactivate the function.

### Adjusting the type of warning

- ▶ Select **Visual & Audible**, **Visual** or **Off**.

### Adjusting the warning threshold

This value determines the speed at which a warning is issued when exceeded.

- ▶ Select **Warning Threshold**.
- ▶ Set the desired speed.



### Blind Spot Assist and Active Blind Spot Assist with exit warning

#### Function of Blind Spot Assist and Active Blind Spot Assist with exit warning

Blind Spot Assist and Active Blind Spot Assist use two lateral, rear-facing radar sensors to monitor the area up to 130 ft (40 m) behind and 10 ft (3 m) next to your vehicle.

If a vehicle is detected at speeds above approximately 8 mph (12 km/h) and this vehicle subsequently enters the monitoring range directly next to your vehicle, the warning lamp in the outside mirror lights up red.

Permanent status display in the instrument cluster:

-  (gray): system is activated but inoperative
-  (green): system is activated and operational

If a vehicle is detected close to your vehicle and you switch on the turn signal indicator in the corresponding direction, a double warning tone sounds and the red warning lamp in the outside mirror flashes. If the turn signal indicator remains switched on, all other detected vehicles are indicated only by the flashing of the red warning lamp.

If you overtake a vehicle quickly, no warning is given.

**⚠ WARNING** Risk of accident despite Blind Spot Assist

Blind Spot Assist does not react to vehicles approaching and overtaking you at a greatly different speed.

Blind Spot Assist cannot warn drivers in this situation.

- ▶ Always pay careful attention to the traffic situation and maintain a safe distance at the side of the vehicle.

Observe the notes on driving systems and your responsibility; you may otherwise fail to recognize dangers (→ page 174).

**Exit warning**

The exit warning is an additional function of Blind Spot Assist and can warn vehicle occupants about approaching vehicles when leaving the vehicle when stationary.

**⚠ WARNING** Risk of accident despite exit warning

The exit warning neither reacts to stationary objects nor to vehicles approaching you at a greatly differing speed.

The exit warning cannot warn drivers in these situations.

- ▶ Always pay particular attention to the traffic situation when opening the doors and make sure there is sufficient clearance.

If there is a vehicle in the monitoring range, this is indicated in the outside mirror. If a vehicle occupant opens the door on the side with the warning, a warning tone sounds and the warning lamp in the outside mirror starts to flash.

This additional function is only available when Blind Spot Assist is active. When the exit warning is activated, it can warn vehicle occupants for up to three minutes after switching the ignition off. The exit warning is no longer available once the warning lamp in the outside mirror flashes three times.

## 232 Driving and parking

The exit warning is only an aid and not a substitute for the attention of vehicle occupants. The responsibility for opening and closing the doors and for leaving the vehicle remains with the vehicle occupants.

### System limits

Blind Spot Assist and Active Blind Spot Assist may be limited in the following situations:

- if there is dirt on the sensors or the sensors are obscured
- in poor visibility, e.g. due to fog, heavy rain or snow
- if there are narrow vehicles, e.g. bicycles or motorbikes
- if the road has very wide or narrow lanes
- if vehicles are not driving in the middle of their lane

Warnings may be issued in error when driving close to crash barriers or similar continuous lane borders. Always make sure that there is sufficient distance to the side for other traffic or obstacles.

Warnings may be interrupted when driving alongside long vehicles, for example trucks, for a prolonged time.

Blind Spot Assist is not operational when reverse gear is engaged.

Blind Spot Assist and the exit warning are not operational when a trailer is coupled to the vehicle and the electrical connection has been correctly established.

The exit warning may be limited in the following situations:

- when the sensors are covered by adjacent vehicles in narrow parking spaces
- when people approach the vehicle
- in the event of stationary or slowly moving objects

### Function of brake application (Active Blind Spot Assist)

If Active Blind Spot Assist detects a risk of a side impact in the monitoring range, a course-correcting brake application is carried out. This is designed to help you avoid a collision.

The course-correcting brake application is available in the speed range between approximately 20 mph (30 km/h) and 125 mph (200 km/h).

**⚠ WARNING** Risk of accident despite brake application of Active Blind Spot Assist

A course-correcting brake application cannot always prevent a collision.

- ▶ Always steer, brake or accelerate yourself, especially if Active Blind Spot Assist warns you or makes a course-correcting brake application.
- ▶ Always maintain a safe distance at the sides.



If a course-correcting brake application occurs, the red warning lamp flashes in the outside mirror and a warning tone sounds. In addition, a display **1** indicating the danger of a side collision appears in the multifunction display.

In rare cases, the system may make an inappropriate brake application. This brake application may be interrupted at any time if you steer slightly in the opposite direction or accelerate.

#### System limits

Note the system limitations of Active Blind Spot Assist; you may otherwise not recognize the dangers (→ page 230).

Either a course-correcting brake application appropriate to the driving situation, or none at all, may occur in the following situations:

- Vehicles or obstacles, e.g. crash barriers, are located on both sides of your vehicle.
- A vehicle approaches too closely on the side.
- You have adopted a sporty driving style with high cornering speeds.
- You brake or accelerate significantly.
- A driving safety system intervenes, e.g. ESP® or Active Brake Assist.
- ESP® is deactivated.
- A loss of tire pressure or a faulty tire is detected.
- You are driving with a trailer and the electrical connection to the trailer hitch has been correctly established.

#### Activating/deactivating Blind Spot Assist or Active Blind Spot Assist

Multimedia system:

→  **▶▶ Settings ▶▶ Assistance**

 Activate or deactivate **Blind Spot Assist**.

or

 Activate or deactivate **Act. Blind Spot Assist**.

#### Active Lane Keeping Assist



##### Function of Active Lane Keeping Assist

Active Lane Keeping Assist monitors the area in front of your vehicle by means of the multifunction camera (→ page 174). It serves to protect you against unintentionally leaving your lane. You will be warned by vibration pulses in the steering wheel and guided by a course-correcting brake application back into your lane.

Active Lane Keeping Assist is available in the speed range between 37 mph (60 km/h) and 124 mph (200 km/h).

Active Lane Keeping Assist can neither reduce the risk of an accident if you fail to adapt your driving style nor override the laws of physics. It cannot take into account road, weather or traffic conditions. Active Lane Keeping Assist is only an aid. You are responsible for maintaining a safe distance to the vehicle in front, for vehicle speed, for braking in good time and for staying in lane.

The status of Active Lane Keeping Assist is displayed in the on-board computer:

-  (green): Active Lane Keeping Assist is active and operating.
-  (gray): Active Lane Keeping Assist is active but not operating.
- : Active Lane Keeping Assist is deactivated or there is a malfunction.



If a lane-correcting brake application occurs, display **1** appears in the multifunction display.

The system does not intervene if you activate the turn signal indicator. If the system detects an obstacle, such as another vehicle in the adjacent

lane, it will intervene regardless of the turn signal indicator.

If you leave the lane without using the turn signal indicator but an obstacle is detected in your lane, the system will not intervene.

You are warned by vibrations in the steering wheel in the following circumstances:

- Active Lane Keeping Assist detects a lane marking.
- A front wheel drives over this lane marking.

#### Conditions for a course-correcting brake application (vehicles without Driving Assistance Package)

Lane markings were detected on both sides of the lane. The front wheel drives over a continuous lane marking.

- **i** A brake application may be interrupted at any time if you steer slightly in the opposite direction.

#### Conditions for a course-correcting brake application (vehicles with Driving Assistance Package)

- A continuous lane marking was detected and driven over with the front wheel.
- A lane marking and an approaching vehicle, an overtaking vehicle or vehicles driving parallel to your vehicle were detected in the adjacent lane. The front wheel drives over the lane marking.
- **i** A brake application may be interrupted at any time if you steer slightly in the opposite direction.

#### System limits

No lane-correcting brake application occurs in the following situations:

- You clearly and actively steer, brake or accelerate.
- If a driving safety system intervenes, such as ESP®, Active Brake Assist or Active Blind Spot Assist.

- You have adopted a sporty driving style with high cornering speeds or high rates of acceleration.
- When ESP® is deactivated.
- When driving with a trailer, the electrical connection to the trailer has been correctly established.
- If a loss of tire pressure or a faulty tire has been detected and displayed.



If you deactivate the Active Lane Keeping Assist warning and the lane markings cannot be clearly detected, it is possible that no lane correcting brake application takes place (→ page 235).

The system may be impaired or may not function in the following situations:

- If there is poor visibility, e.g. due to insufficient illumination of the road, if there are highly variable shade conditions or in rain, snow, fog or heavy spray.
- If there is glare, e.g. from oncoming traffic, the sun or reflections.
- If the windshield in the area of the multifunction camera is dirty, or if the camera is fogged up, damaged or covered.
- If there are no lane markings, or several unclear lane markings are present for one lane, e.g. around roadworks.
- If the lane markings are worn, dark or covered.
- If the distance from the vehicle in front is too short and thus the lane markings cannot be detected.
- If the lane markings change quickly, e.g. lanes branch off, cross one another or merge.
- If the road is very narrow and winding.
- **Vehicles with Driving Assistance Package:** if the radar sensors in the rear bumper are dirty or covered in snow and an obstacle is detected in your lane, no lane-correcting brake application takes place.

### Activating/deactivating Active Lane Keeping Assist

Multimedia system:

  [» Settings](#) [» Quick Access](#)  
[» Active Lane Keeping Assist](#)

 Activate or deactivate the function.

### Setting Active Lane Keeping Assist

Multimedia system:

  [» Settings](#) [» Assistance](#)  
[» Active Lane Keeping Assist](#)

### Setting the sensitivity

 The availability of this function is dependent on the country.

 Select **Standard**, **Sensitive** or **Off**.

### Activating or deactivating the haptic warning

 Select **Warning**.  
 Activate or deactivate the function.

## Trailer hitch

### Notes on trailer operation

**Mercedes-AMG vehicles:** observe the notes in the Supplement. You could otherwise fail to recognize dangers.

**⚠ WARNING** Risk of accident due to unsuitable ball neck

If you install an unsuitable ball neck, this may result in the trailer hitch and rear axle being overloaded.

As a consequence, the handling characteristics may be heavily impaired and the trailer could become detached. There is a risk of fatal injury.

- ▶ Only install a ball neck that conforms to the permitted dimensions and has been designed for the requirements of trailer operation.
- ▶ Do not change the ball neck or the trailer hitch.

The values approved by the manufacturer can be found on the identification plates and in the "Technical data" section under "Trailer hitch" for the towing vehicle (→ page 366).

**⚠ WARNING** Swerving of the vehicle/trailer combination due to increased speed

You could lose control of the vehicle/trailer combination.

The vehicle/trailer combination may even tip over.

- ▶ Under no circumstances should you try to straighten the vehicle/trailer combination by increasing the speed.
- ▶ Reduce your speed and do not counter-steer.
- ▶ If necessary, apply the brakes.

**ⓘ NOTE** Damage to the engine as a result of overheating

- ▶ If you retrofit a trailer hitch, modifications to the engine cooling system may

be necessary, depending on the vehicle model.

When retrofitting a trailer hitch, observe the fastening points on the chassis.

Retrofitting a trailer hitch is permissible only if a trailer load is specified in your vehicle documents. If this is not the case, the vehicle is not approved for trailer operation.

Further information can be obtained at a qualified specialist workshop.

If the trailer coupling is detachable, it is essential to comply with the operating instructions of the trailer coupling manufacturer.

Couple and uncouple the trailer carefully. If you do not connect the trailer to the towing vehicle correctly, the trailer may become detached.

Observe the following notes on the tongue weight:

- Do not use a tongue weight that exceeds or falls below the permissible tongue weight
- Use a tongue weight as close as possible to the maximum tongue weight



Do not exceed the following values:

- Permissible towing capacity
- Permissible rear axle load of the towing vehicle
- Permissible gross mass of the towing vehicle
- Permissible gross mass of the trailer
- Maximum permissible speed of the trailer

Ensure the following before starting a journey:

- The tire pressure on the rear axle of the towing vehicle is set for a maximum load
- The lighting of the connected trailer is operational

In the event of increased rear axle load, the vehicle/trailer combination may not exceed a maximum speed of 62 mph (100 km/h) for reasons concerning the operating permit. This also applies in countries in which the permissible maximum speed for vehicle/trailer combinations is above 62 mph (100 km/h).

#### **Vehicles with AIRMATIC or E-ACTIVE BODY**

**CONTROL:** if the socket of the trailer hitch is occupied, e.g. by a trailer or rear bicycle rack,

the vehicle is set to the normal level regardless of the drive program at speeds greater than 19 mph (30 km/h).

#### **Attaching the ball neck**

**⚠ WARNING** Risk of accident and injury due to an incorrectly installed ball coupling

If the ball coupling is not installed and engaged correctly, it may become detached during travel and endanger other road users. There is a risk of fatal injury.

- ▶ Install and secure the ball coupling as described in the ball coupling manufacturer's installation instructions.
- ▶ When the ball coupling has been installed, ensure that it is correctly secured before every trip.

**⚠ WARNING** Risk of accident due to an incorrectly installed and secured ball coupling

If the ball coupling has not been correctly installed and secured, the trailer can become detached.

- ▶ Install and secure the ball coupling as described in the ball coupling manufacturer's installation instructions.
- ▶ When the ball coupling has been installed, ensure that it is correctly secured before every trip.

#### **Requirements:**

- The vehicle is secured against rolling away.

### Attaching the ball neck

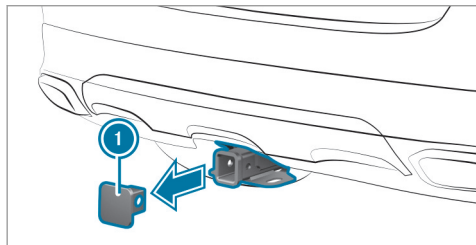

- ▶ Remove cover ① from the ball neck mount in the direction of the arrow.
- ▶ Store cover ① so that it cannot move around.
- ▶ Observe the manufacturer's installation instructions.

Observe the notes on loading the vehicle.

### Coupling or uncoupling a trailer

**⚠ WARNING** Risk of injury from the vehicle level being changed

**Vehicles with level control system:** the vehicle level may be changed unintentionally, e.g. by other persons. You may become trapped if you couple up or uncouple a trailer while the vehicle level is changing. In addition, other people could become trapped if their limbs are between the vehicle body and the tires or underneath the vehicle.

When coupling up or uncoupling a trailer, make sure that:

- ▶ The doors or tailgate are not opened or closed.
- ▶ You do not initiate the level control system and do not operate the DYNAMIC SELECT switch.
- ▶ Do not lock or unlock the vehicle.

#### Requirements:

- The vehicle is secured with the electric parking brake.

- The transmission is in position **P**.

The trailer will be correctly detected by the vehicle only if the following conditions are met:

- The trailer is connected correctly.
- The trailer lighting system is in working order.

The functions of the following systems will be affected by a correctly connected trailer:

- Active Lane Keeping Assist
- ESP<sup>®</sup> trailer stabilization
- Parking Assist PARKTRONIC
- Active Parking Assist
- Blind Spot Assist or Active Blind Spot Assist
- Drive Away Assist
- Cross Traffic Alert
- Rear view camera
- Surround view camera
- AIR BODY CONTROL
- AIRMATIC
- E-ACTIVE BODY CONTROL

**Vehicles without level control:** the ball head height will change depending on the vehicle's load. In this case, use a trailer with a height-adjustable drawbar.

### Coupling up a trailer

**!** **NOTE** Damage to the starter battery due to full discharge

Charging the trailer battery using the power supply of the trailer can damage the starter battery.

- ▶ Do not use the vehicle's power supply to charge the trailer battery.

Information about a suitable ball neck for Mercedes-Benz vehicles can be obtained from a qualified specialist workshop, e.g. an authorized Mercedes-Benz Center.

- ▶ Remove the cover cap from the ball neck mount and store it in a safe place (→ page 237).
- ▶ Position the trailer on a level surface behind the vehicle and couple it up to the vehicle.

- ▶ Establish the electrical connection between the vehicle and the trailer.

**i** Accessories can be connected to the permanent power supply up to 180 W and to the power supply that is switched on via the ignition lock.

### Uncoupling a trailer

**!** **WARNING** Risk of being crushed and becoming trapped when uncoupling a trailer

When uncoupling a trailer with an engaged inertia-activated brake, your hand may become trapped between the vehicle and the trailer drawbar.

- ▶ Do not uncouple trailers with an engaged overrun brake.

**!** **NOTE** Damage when uncoupling in a state of overrun

Uncoupling in a state of overrun can damage the vehicle.

- ▶ Do not uncouple trailers with an engaged overrun brake.

**!** **WARNING** Risk of becoming trapped when disconnecting the trailer cable

**Vehicles with level control system:** The vehicle may lower when the trailer cable is disconnected.

This could result in you or other people becoming trapped if your or their limbs are between the vehicle body and the tires or underneath the vehicle.

- ▶ Make sure that nobody is underneath the vehicle or in the immediate vicinity of the wheel arches when you disconnect the trailer cable.

- ▶ Disconnect the electrical connection between the vehicle and the trailer.
- ▶ Uncouple the trailer.
- ▶ Place the cover cap on the ball neck mount.

### Vehicle towing instructions

The vehicle is not suitable for the use of tow bar systems that are used for flat towing or dinghy towing, for example. Attaching and using tow bar systems can lead to damage on the vehicle.

When you are towing a vehicle with tow bar systems, safe driving characteristics cannot be guaranteed for the towing vehicle or the towed vehicle. The vehicle-trailer combination may swerve from side to side. Comply with the permitted towing methods (→ page 313) and the instructions for towing with both axles on the ground (→ page 314).

### Notes on the Instrument Display and on-board computer

#### **▲ WARNING** Risk of accident due to an Instrument Display malfunction

If the Instrument Display has failed or malfunctioned, the function restrictions applying to safety relevant systems are not visible.

The operating safety of your vehicle may be impaired.

- ▶ Drive on carefully.
- ▶ Have the vehicle checked immediately at a qualified specialist workshop.

#### **▲ WARNING** Risk of distraction from information systems and communications equipment

If you operate information and communication equipment integrated in the vehicle when driving, you will be distracted from the traffic situation. This could also cause you to lose control of the vehicle.

- ▶ Only operate this equipment when the traffic situation permits.
- ▶ If you cannot be sure of this, stop the vehicle whilst paying attention to road and traffic conditions and operate the equipment with the vehicle stationary.

You must observe the legal requirements for the country in which you are currently driving when operating the on-board computer.

The on-board computer shows only display messages and warnings from specific systems on the multifunction display. You must therefore ensure that your vehicle is always reliable.

If the operating safety of your vehicle is impaired, park the vehicle immediately and safely. Contact a qualified specialist workshop.

**Mercedes-AMG vehicles:** be sure to observe the notes in the Supplement. You could otherwise fail to recognize dangers.

## Instrument Display overview

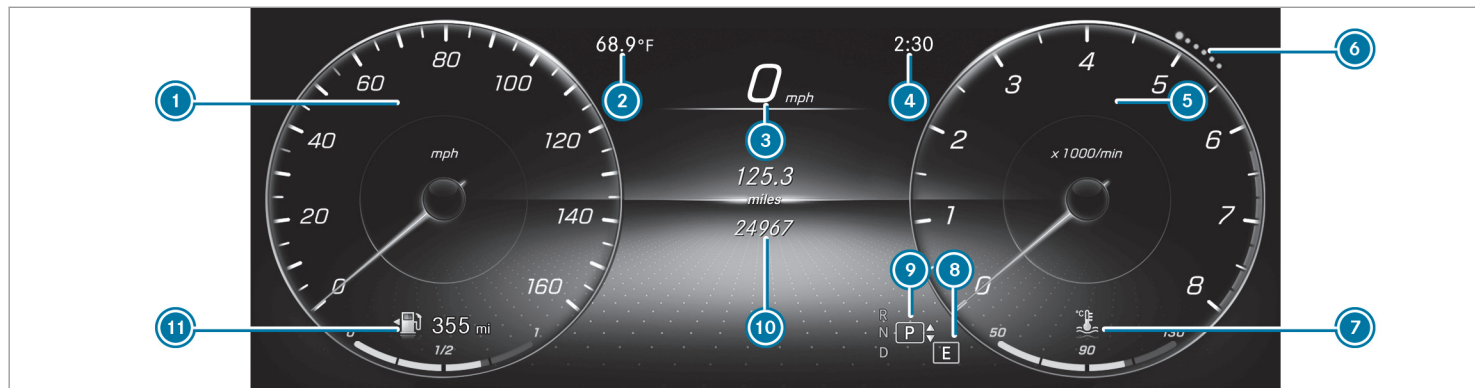

- ① Display content on left (example: speedometer): speedometer/time /date/trip computer **From Start** and **From Reset**/range/audio/angle of incline and approach/departure

The segments on the speedometer indicate the status of the following systems: cruise

control/limiter/Active Distance Assist DISTRONIC

- ② Outside temperature  
 ③ Digital speedometer  
 ④ Time  
 ⑤ Display content on right (example: tachometer): tachometer/average fuel consumption/ECO display/navigation/G-

meter/assistant display/4MATIC/suspension (equipment-dependent)

The fuel supply will be interrupted to protect the engine when the red mark on the tachometer (overrevving range) is reached.





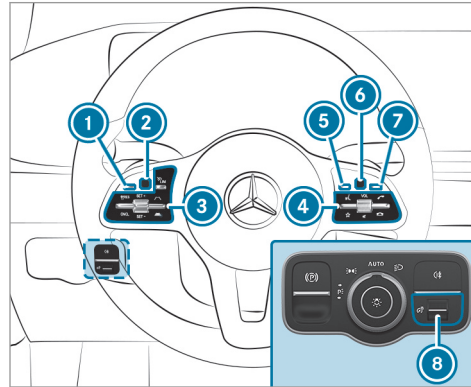

- ⑥ Index points  
 These show the selected display or menu content.

- ⑦ Coolant temperature display  
The coolant temperature display is permitted to rise to 248°F during normal operation. Vehicles with 48 V on-board electrical system: POWER and CHARGE display (electrical drive support and recuperation power of the electric motor)
- ⑧ Selected drive program
- ⑨ Selected transmission position
- ⑩ Multifunction display (example: standard display for trip): Assistance/Telephone/Navigation/Trip/Media/Radio/Styles and displays/Service
- ⑪ Fuel level, fuel filler flap location indicator, range

### Overview of the buttons on the steering wheel



- ①  Back/Home button, on-board computer  
Press and hold: shows standard display
- ② Touch Control, on-board computer
- ③ Control panel for cruise control or Active Distance Assist DISTRONIC

- ④ Control panel for MBUX multimedia system:
  -  Voice Control System
  -  Displays favorites
  - VOL: control knob, adjusts the volume or switches the sound off  (press)
  -  Makes/accepts a call
  -  Rejects/ends a call
  - ⑤  Calls up the home screen
  - ⑥ Touch Control multimedia system
  - ⑦  Back button
  - ⑧ Brightness control to adjust the lighting in the Instrument Display and in the control elements of the vehicle interior

### Operating the on-board computer

Observe the legal requirements for the country in which you are currently driving when operating the on-board computer.

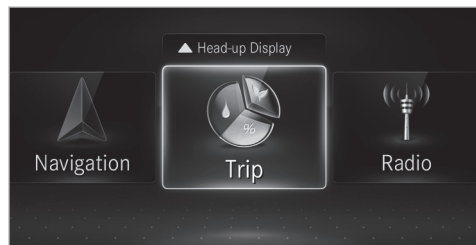

The on-board computer is operated using the left-hand Touch Control and the left-hand back/home button.

When the on-board computer is being operated, different acoustic signals will sound as operating feedback, e.g. when the end of a list is reached or when you are scrolling through a list.

The following menus are available:

- Assistance
- Phone
- Navigation
- Trip
- Radio

- Media
- Designs & Disp.
- Service

**i** You can find information about the possible settings and selections on the menus in the Digital Operator's Manual.

**▶ To call up the menu bar:** briefly press the left-hand back button until the menu bar is displayed.

**i** **Vehicles without Active Distance Assist DISTRONIC:** press the  button to call up the menu bar of the on-board computer.

**▶ To scroll in the menu bar:** swipe left or right on the left-hand Touch Control.

**▶ To call up a menu, submenu or possible settings on the menu, or confirm a selection or setting:** press the left-hand Touch Control.

**▶ To scroll through displays or lists on the menu, or select display content, a function, an entry or a display:** swipe upwards

or downwards on the left-hand Touch Control.

**▶ To exit a submenu:** press the left-hand back button.

### Selecting the Head-up Display

**▶ To switch on the Head-up Display:** switch on the Head-up Display via the multimedia system or activate it in the menu bar by swiping upwards on the left-hand Touch Control. The Head-up Display menu has been selected on the Head-up Display.

**▶ To switch to the Head-up Display:** press the left-hand Touch Control or swipe upwards on the left-hand Touch Control.

**▶ To select what the Head-up Display shows:** swipe upwards or downwards on the left-hand Touch Control.

### Full-screen menus

You can display the following menus in full on the Instrument Display:

- Assistance
- Trip



- **Navigation**

- ▶ On the corresponding menu, use the left-hand Touch Control to scroll to the end of the list.
- ▶ Press the left-hand Touch Control. The selected menu will be displayed in full.

### Overview of what is shown on the multi-function display

Also shown on the multifunction display:



Active Parking Assist (→ page 224)



Parking Assist PARKTRONIC deactivated (→ page 215)



Cruise control (→ page 185)



Active Distance Assist DISTRONIC (→ page 188)



Active Brake Assist (→ page 180)



Active Steering Assist (→ page 195)



Active Traffic Jam Assist (→ page 199)



Active Lane Keeping Assist (→ page 233)



Active Lane Change Assist (→ page 197)



ECO start/stop function (→ page 153)



HOLD function (→ page 200)



Adaptive Highbeam Assist (→ page 124)

**Vehicles with Traffic Sign Assist:** Detected instructions and traffic signs (→ page 229).

For an overview of the indicator and warning lamps, see (→ page 417).

## Head-up Display

### Function of the Head-up Display

The Head-up Display projects the following information above the cockpit into the driver's field of vision:

- Driving speed
- Information from the navigation system
- Information from the driving systems and driving safety systems
- Some warning messages

Depending on the vehicle's equipment, different content can be shown in the three display areas of the Head-up Display (→ page 246).

### Display content

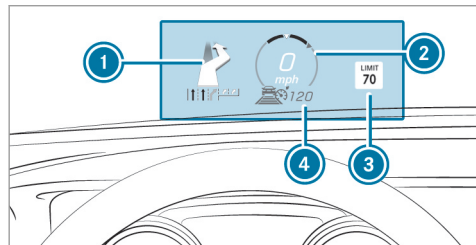

- ① Navigation instructions
- ② Current speed
- ③ Detected instructions and traffic signs
- ④ Set speed in the driving system (e.g. cruise control)

### System limits

The visibility of the displays will be affected by the following conditions:

- Seat position
- Image position setting
- Ambient light

- Wet road
- Objects on the display cover
- Polarization in sunglasses

❗ In extreme sunlight, sections of the display may appear washed out. You can correct this by switching the Head-up Display off and on again.

### Setting the Head-up Display using the on-board computer

On-board computer:

➔ **HEAD-UP DISPLAY**

The following Head-up Display settings can be selected:

- Position
- Brightness
- Displays
- Messages
- Assistance status
- Telephone
- Audio

- Voice Control System

▶ **To choose a setting:** swipe to the right on the left-hand Touch Control. The Settings menu (S) will be selected.

▶ **To call up the Settings menu:** press the left-hand Touch Control.

▶ **To adjust the position:** swipe upwards or downwards on the left-hand Touch Control.

▶ **To adjust the brightness:** swipe to the left or right on the left-hand Touch Control.

▶ **To set messages, assistance status, telephone, audio and the Voice Control System:** press the left-hand Touch Control. The list of setting options will be displayed.

▶ Swipe upwards or downwards on the left-hand Touch Control and select a setting by pressing the left-hand Touch Control.

### Selecting what the Head-up Display shows

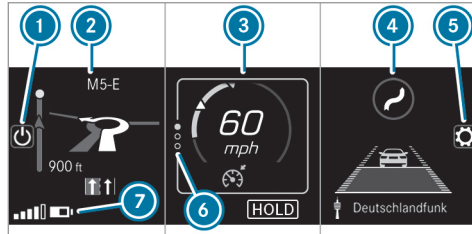

(Example)

- ① Switches the Head-up Display on/off
- ② Left display area
  - Navigation system
  - Inclination, gradient and compass
  - Average consumption
  - G-meter
- ③ Central display area
  - Set speed in the driver assistance system, e.g. cruise control
  - Warnings from driver assistance systems, e.g. distance warning

- ④ Right display area
  - Traffic Sign Assist
  - Vehicle level
  - Differential
  - Assistant display
- ⑤ Adjusts the position, brightness and lower display area
- ⑥ Index points
- ⑦ Lower display area

Display areas ② to ④ that are not required can be hidden.

- ① In audio mode, the station name or track will be shown temporarily when the audio source is being actively operated. In addition, the latest calls will be displayed when the telephone list on the Instrument Display is actively operated.

- ▶ **To select a display:** swipe upwards on the left-hand Touch Control.
- ▶ Press the left-hand Touch Control.

### Switching the Head-up Display on/off via the multimedia system

Multimedia system:

▶ ▶ Settings ▶ Quick Access

- ▶ Select HUD.
- ▶ The Head-up Display is activated.

## Overview and operation

### Notes on the MBUX multimedia system

**⚠ WARNING** Risk of distraction from information systems and communications equipment

If you operate information and communication equipment integrated in the vehicle when driving, you will be distracted from the traffic situation. This could also cause you to lose control of the vehicle.

- ▶ Only operate this equipment when the traffic situation permits.
- ▶ If you cannot be sure of this, stop the vehicle whilst paying attention to road and traffic conditions and operate the equipment with the vehicle stationary.

You must observe the legal requirements for the country in which you are currently driving when operating the multimedia system.

### Overview of the MBUX multimedia system

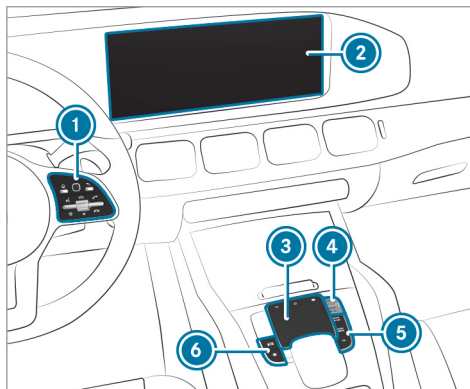

- ① Touch Control and control panel for the MBUX multimedia system
- ② Media display with touch functionality
- ③ Touchpad
- ④ Controller  
Turning: adjusts the volume

Press briefly: switches the mute function on/off

Press and hold: switches the multimedia system or media display on or off

- ⑤ Buttons for navigation, radio/media and telephone
- ⑥ Buttons for vehicle functions/system settings and favorites/themes

Further operating options:

- Conducting a voice dialog with the Voice Control System.
- Operating functions contact-free with the MBUX Interior Assistant.
- ① You can find further information about operation as well as about applications and services in the Digital Operator's Manual.

#### Anti-theft protection

This device is equipped with technical provisions to protect it against theft. Further information on protection against theft can be obtained from an authorized Mercedes-Benz Center.

## Home screen overview

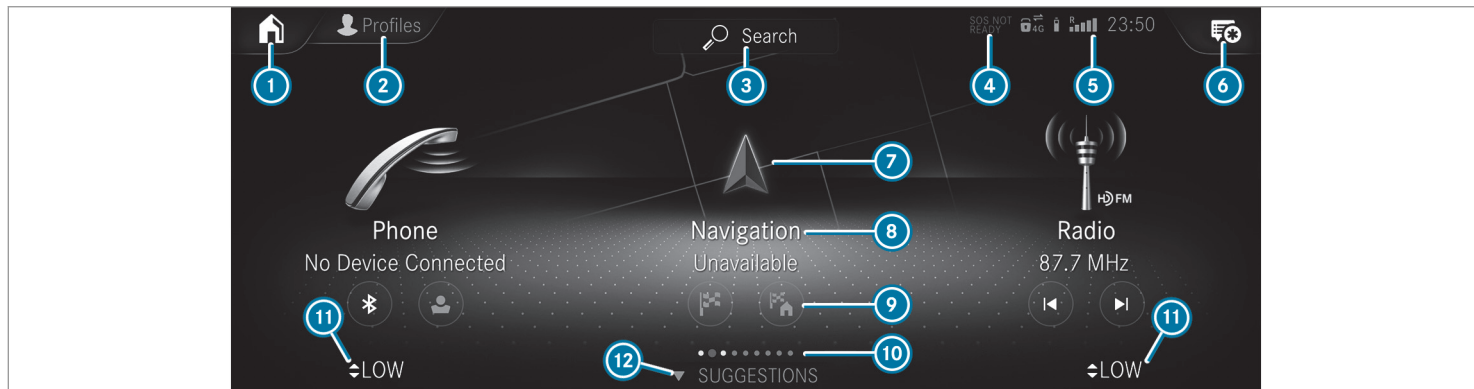

- ① Depending on the display, calls up the first three applications or the home screen
- ② Calls up the profile
- ③ Calls up the global search
- ④ SOS NOT READY (only when the Mercedes-Benz emergency call system is not available)

- ⑤ Signal strength of the mobile phone network, network display, battery status of the mobile phone connected, time
- ⑥ Calls up the Notifications Center
- ⑦ Calls up an application using the symbol
- ⑧ Application and current information
- ⑨ Quick-access, e.g. enter home address

- ⑩ Index points and selected display area
- ⑪ Calls up the air conditioning menu
- ⑫ Calls up **SUGGESTIONS, THEMES and FAVORITES**

## Operating the MBUX multimedia system

### Using Touch Control

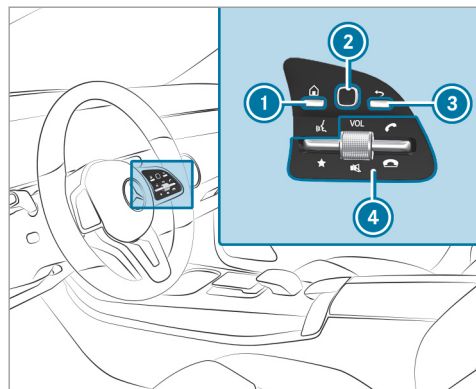

- ① Calls up the home screen
- ② Touch Control
- ③ Pressing briefly: returns to the previous display
- ④ Pressing the rocker switch down briefly: shows favorites

- Pressing the rocker switch down and holding: adds favorites and themes
- VOL: control adjusts the volume or switches the sound off (press)
- Pressing the rocker switch up: makes or accepts a call
- Pressing the rocker switch down: rejects or ends a call

Navigation through the menus is carried out with Touch Control ② with single-finger swipes.

- ▶ **To select a menu option:** swipe and press.
- ▶ **To move the digital map:** swipe in any direction.

### Using the touchscreen

- ▶ Select menu options, symbols or characters by pressing briefly.
- ▶ **To navigate in menus:** swipe up, down, left or right.
- ▶ **To use handwriting to enter characters:** write the character with one finger on the touchscreen.

- ▶ **To zoom in and out of the map:** move two fingers together or apart.
- ▶ **To call up the global menu:** press and hold on the touchscreen until the **OPTIONS** menu appears.

### Using the touchpad

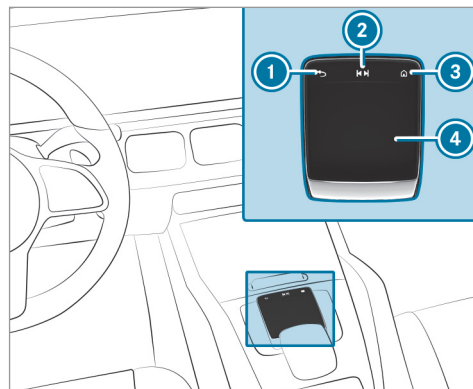

- ① Returns to the previous display
- ② Calls up the audio control menu





Swiping to the left or right: selects the previous or next radio station/music track

- ③  Calls up the home screen
- ④ Touchpad

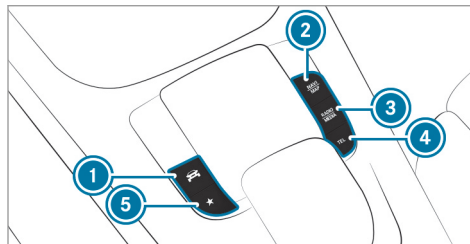
- ▶ **To select a menu option:** swipe and press.
- ▶ **To use handwriting recognition:** write a character on the touchpad.
- ▶ **To open or close the Notifications Center:** swipe down or up with two fingers.
- ▶ **To zoom in and out of the map:** move two fingers together or apart.

### Calling up applications using buttons



- ①  Calls up vehicle functions
- ②  Calls up navigation
- ③  Calls up radio or media
- ④  Calls up the telephone
- ⑤  Press briefly: calls up favorites  
Press and hold: adds a favorite or theme

▶ Alternatively, tap  on the touchscreen.  
or

▶ Press the  button on the Touch Control or on the touchpad.  
The home screen appears.

▶ Call up the application (→ page 249).

### Functions of the Voice Control System

With the Voice Control System, various applications in the MBUX multimedia system are operable using voice input. The Voice Control System is operational approximately thirty seconds after the ignition is switched on and is available for the driver's seat and front passenger seat.

The following multimedia system applications can be operated:

- Navigation
- Telephone
- Radio and TV
- Media player
- Messages
- Vehicle functions

### Starting the Voice Control System

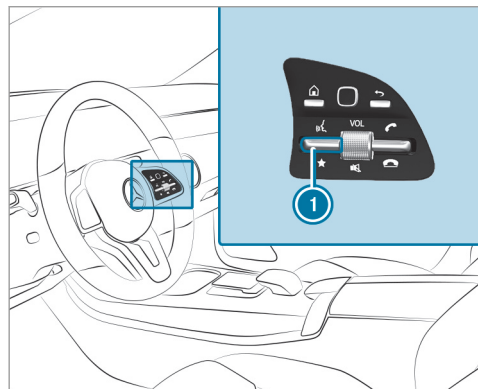

- ▶ Press rocker switch ① up.
- or
- ▶ Say "Hey Mercedes".

### Overview of the MBUX Interior Assistant

**⚠ WARNING** Risk of injury due to laser beams from the camera

This product uses a class 1 laser system. If the housing is opened or damaged, invisible laser beams could damage your retina.

- ▶ Do not open the housing.
- ▶ Always have maintenance work and repairs carried out by a qualified specialist workshop.

This product complies with the requirements of the FDA 21 CFR 1040.10 and 1040.11 with exception of the variations according to the FDA Laser Notice No. 50 from 24. June 2007.

The camera is located in the overhead control panel.

If the vehicle is equipped with the MBUX Interior Assistant, selected functions of the multimedia system can be operated contact-free. The MBUX Interior Assistant can differentiate between driver and front passenger interactions and detects specific hand positions (poses).

For further information on system limits, display messages and troubleshooting notes, see the Digital Operator's Manual.



The MBUX Interior Assistant supports the following interactions:

Interaction area	Interaction	Description
In front of the media display or above the touchpad	Proximity to the control element	The Interior Assistant recognizes the approach of the hand towards a control element. Depending on the active application, the display will be adjusted in the media display. Some functions differentiate between driver and front passenger. No specific hand position is required.
Above the center console	Defined poses	With defined poses a function is triggered depending on the application active.
Below the inside rearview mirror	Brief up and down movements	With brief vertical up and down movements below the inside rearview mirror the reading light for the driver or the front passenger is switched on and off.
Front passenger seat	Stretching out a hand above the front passenger seat	By stretching out a hand above the front passenger seat the search light is switched on. If you withdraw a hand from this area, the search light is switched off again.

### Switching the reading light and search light and on or off

#### Requirements:

- **For the reading light:** the function is available when it is dark.
- The hand movement takes place in the interaction area below the inside rearview mirror.
- **For the search light:** the function is available when it is dark.
- The hand movement takes place in the interaction area above the front passenger seat.

- The seat belt on the front passenger seat must **not** be inserted in the seat belt buckle.

### Switching the reading light on and off



- ▶ Briefly move a hand up or down beneath the inside rearview mirror. The reading light is switched on or off for the driver or front passenger.

### Switching the search light on and off

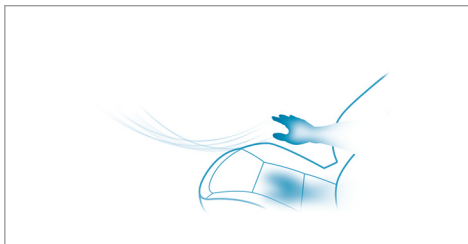

- ▶ **To switch on:** reach across the front passenger seat with a hand. The search light is switched on for the driver.
- ▶ **To switch off:** take a hand back away from the front passenger seat. The search light is switched off again.

### Information on profiles, themes, suggestions and favorites

**⚠ WARNING** Risk of becoming trapped during adjustment of the driver's seat after calling up a driver profile

Selecting a profile may trigger an adjustment of the driver's seat to the position saved under the profile. You or other vehicle occupants could be injured in the process.

- ▶ Make sure that when the position of driver's seat is being adjusted using the multimedia system, no people or body parts are in the seat's range of movement.

If there is a risk of someone becoming trapped, stop the adjustment process immediately:

- ▶ a) Tap the warning message on the media display.

or

- ▶ b) Press a memory position button or a seat adjustment switch on the driver's door.  
The adjustment process is stopped.

The driver's seat is equipped with an access preventer.

If the driver's door is open, the driver's seat will **not** be set after calling up the driver's profile.

Profiles store your vehicle settings and settings for the multimedia system. If the vehicle is used by several drivers, the driver can select their own profile without needing to change the settings of other drivers.

 Information on profiles from Mercedes me connect can be found in the Digital Operator's Manual.

Vehicle settings are, for example, driver's seat, steering wheel and mirror settings, climate control and ambient lighting. For the settings of the multimedia system, you can select, for example, radio stations, previous destinations as well as themes, suggestions and favorites.

For recurring driving situations, such as long drives on the freeway, you can save your preferred settings in a theme in the vehicle. In a theme you can save the display of the digital map, your preferred radio station and preferred drive program, for example.

The vehicle can learn the habits of the driver. It then offers suggestions for the most probable navigation destinations, media sources, radio stations or contacts. The requirements for that are the selection of a profile, your consent to the recording of data and sufficient collected data.



Favorites provide quick access to applications that are used often. You can select favorites from categories or add them directly to an application.

## Configuring profiles, themes and suggestions

Multimedia system:



### Creating a new profile

- ▶ Select  **Create Profile** .
- ▶ Select an avatar.
- ▶ Enter the name and confirm with  .
- ▶ Select **Continue**  .
- ▶ Select **Current Settings**.
- ▶ Select **Save**.
- ▶ Activate Bluetooth® and select **Connect Phone**, to connect a mobile phone with the user profile .
- ▶ Select **Finish**.

### Selecting profile options

- ▶ Select  for a profile.

The following functions are available:

- Editing, resetting or deleting a profile
- Resetting themes or favorites





- Configuring suggestions

### Configuring suggestions

- ▶ Select  for a profile.
- ▶ Select [Suggestion Settings](#).
- ▶ Switch [Allow Destination Suggestions](#), [Allow Music Suggestions](#) and [Allow Contact Suggestions](#) on or off.
- ▶ **To deactivate the learning function for one day:** activate [Deactivate 24h Intelligent Learning](#).  
For 24 hours no new actions will be trained and no data recorded for the active profile. Suggestions will continue to be shown.  
Example: if the option is switched on and a route to a new destination has been calculated, this destination would not be taken into account for the learning function.

### Creating new themes

- ▶ Select .
- ▶ Select [THEMES](#).

- ▶ Select  [Create Theme](#).  
The settings which are saved in the theme are shown.
- ▶ Select [Continue](#) .
- ▶ Select [Audio](#) and [Navigation](#) (Navigation) and store the active settings in the theme.
- ▶ Select [Continue](#) .
- ▶ Select an entry screen.
- ▶ Select [Continue](#) .
- ▶ Select an image.
- ▶ Enter the names into the entry field and confirm with .
- ▶ Select [Save](#).

## System settings

### Overview of the system settings menu

In the system settings menu, you can make settings in the following menus and control elements:

- Display
  - Styles
- Instrument lighting
- Display brightness
- Edge lighting
- Day/night design
- Control elements
  - Keyboard language and handwriting recognition
  - Touchpad sensitivity
  - Sensitivity of the Touch Controls
- Voice Control System
- MBUX Interior Assistant
- Sound
  - Entertainment
  - Navigation and traffic announcements
  - Telephone
  - Voice amplification to the rear passenger compartment
- Connectivity
  - Wi-Fi, Bluetooth, NFC
- MBUX Remote Control

- Authorizing and de-authorizing devices
- Time & date
- Language
- Units for distance
- Software updates
- Data import/export
- PIN protection
- System Reset

### Information on important system updates

Important system updates may be necessary for the security of your multimedia system's data. Install these updates, or else the security of your multimedia system cannot be ensured.

A system update consists of three steps:

- Downloading or copying of the data required for installation
- Installation of the downloaded system update
- Activation of the downloaded system update by restarting the system

- ① If automatic software updates are activated, the system updates will be downloaded automatically.

The multimedia system provides a message when a system update is available.

You have the following selection options:

- **Accept and Install**  
The system update will be downloaded in the background.
- **Information**  
Information about the pending system update is displayed.
- **Later**  
The system update can be downloaded manually at a later time.

### **Deep system updates**

Deep system updates access vehicle or system settings and can therefore only be carried out when the vehicle is stationary and the ignition is switched off.

If the download of a deep system update is completed and the downloaded system update is

ready for installation, you will be informed of this after the next ignition cycle, for example.

- ① Park the vehicle safely in a suitable location before starting the installation.

Requirements for the installation:

- The ignition is switched off.
- Notes and warnings have been read and accepted.
- The electric parking brake is applied.

If all requirements have been fulfilled, the downloaded system update is installed. The multimedia system cannot be operated while the downloaded system update is being installed and vehicle functions are restricted.

If errors should occur during the installation, the multimedia system automatically attempts to restore the previous version. If restoration of the previous version is not possible, a symbol appears on the media display. Consult a qualified specialist workshop to resolve the problem.

## Setting up a Wi-Fi hotspot

### Requirements:

- **To set up the Wi-Fi connection of the multimedia system with external hotspots:** there is no communication module installed.
- The device to be connected supports at least one of the types of connection described.

Multimedia system:

- ▶  ▶ Settings ▶ System
- ▶ Wi-Fi & Bluetooth

### Activating/deactivating Wi-Fi

- ▶ Select **Wi-Fi**.

### Connecting the multimedia system with an external hotspot using Wi-Fi

The type of connection established must be selected on the multimedia system and on the device to be connected.

- ① The connection procedure may differ depending on the device. Follow the instructions that are shown in the display. Further information can be found in the manufacturer's operating instructions.

- ▶ Select **Internet Settings**.
- ▶ Select **Connect via Wi-Fi**.
- ▶ Select **Add Hotspot**.

### Connecting using a security key

- ▶ Select the options  of the desired Wi-Fi network.
- ▶ Select **Connect Using Security Key**.
- ▶ Have the security key displayed on the device to be connected (see the manufacturer's operating instructions).
- ▶ Enter this security key on the multimedia system.
- ▶ Confirm the entry with **ok**.

### Connecting using a WPS PIN

- ▶ Select the options  of the desired Wi-Fi network.
- ▶ Select **Connect via WPS PIN Input**. The multimedia system generates an eight-digit PIN.
- ▶ Enter this PIN on the device to be connected.
- ▶ Confirm the entry.

### Connecting using a button

- ▶ Select the options  of the desired Wi-Fi network.
- ▶ Select **Connect via WPS PBC**.
- ▶ Select "Connect via WPS PBC" in the options on the device to be connected (see the manufacturer's operating instructions).
- ▶ Press the WPS button on the device to be connected.
- ▶ Select **Continue** in the multimedia system.

### Activating automatic connection

- ▶ Select **Connect via Wi-Fi**.
- ▶ Select the options  of the desired Wi-Fi network.
- ▶ Activate **Permanent Internet Connection**.

### Connecting with a known Wi-Fi

- ▶ Select **Connect via Wi-Fi**.
- ▶ Select a Wi-Fi network.
- ▶ The connection is established again.

### Configuring the multimedia system as a Wi-Fi hotspot for external devices

The type of connection established depends on the device to be connected. The function must be supported by the multimedia system and by the device to be connected. The type of connection established must be selected on the multimedia system and on the device to be connected.

- ▶ Select **Vehicle Hotspot**.
- ▶ Select **Connect Device to Vehicle Hotspot**.

### Connecting using WPS PIN generation

- ▶ Select **Connect via WPS PIN Generation**.
- ▶ Enter the PIN shown in the media display on the device to be connected and confirm.

### Connecting using WPS PIN entry

- ▶ Select **Connect via WPS PIN Input**.
- ▶ Enter the PIN that is shown on the external device's display on the multimedia system.

### Connecting using a button

- ▶ Select **Connect via WPS PBC**.

- ▶ Press the push button on the device to be connected (see the manufacturer's operating instructions).
- ▶ Select **Continue**.

### Connecting using a security key

- ▶ Select **Connect Device to Vehicle Hotspot**. A security key is displayed.
- ▶ Select the vehicle from the device to be connected. The vehicle is displayed with the **MB Hotspot XXXXX** network name.
- ▶ Enter the security key which is shown in the media display on the device to be connected.
- ▶ Confirm the entry.

### Connecting using NFC

- ▶ Select **Connect via NFC**.
- ▶ Activate NFC on the mobile device (see the manufacturer's operating instructions).
- ▶ Bring the mobile device into the NFC interface of the vehicle.
- ▶ Select **Finished**.  
The mobile device is now connected to the multimedia system hotspot via NFC.

### Generating a new security key

- ▶ Select **Vehicle Hotspot**.
- ▶ Select **Generate Security Key**.  
A connection will be established with the newly created security key.
- ▶ **To save a security key:** select **Save**.  
When a new security key is saved, all existing Wi-Fi connections are then disconnected. If the Wi-Fi connections are being re-established, the new security key must be entered.

## Navigation

### Notes on navigation

### Route guidance with augmented reality

- ⚠ **WARNING** Risk of accident and injury as a result of distraction, incorrect depiction or wrong interpretation of the display

The camera image of the augmented reality display is not suitable as a guide for driving.

- ▶ Always keep an eye on the actual traffic situation.
- ▶ Avoid extended observation of the camera image.

**⚠ WARNING** Risk of accident and injury due to imprecise positioning of additional information

The additional information from the augmented reality display is not a substitute for observing the actual driving situation.

- ▶ Always keep an eye on the actual traffic situation when carrying out all driving maneuvers.

The navigation menu is hidden if route guidance is active.

- ▶ **To show:** tap on the touchscreen. The menu is hidden automatically.

### Switching navigation on

---

Multimedia system:

→  ▶ **Navigation** (Navigation)

- ▶ Alternatively: press the  button. The map shows the vehicle's current position. The navigation menu is shown.



## Navigation overview

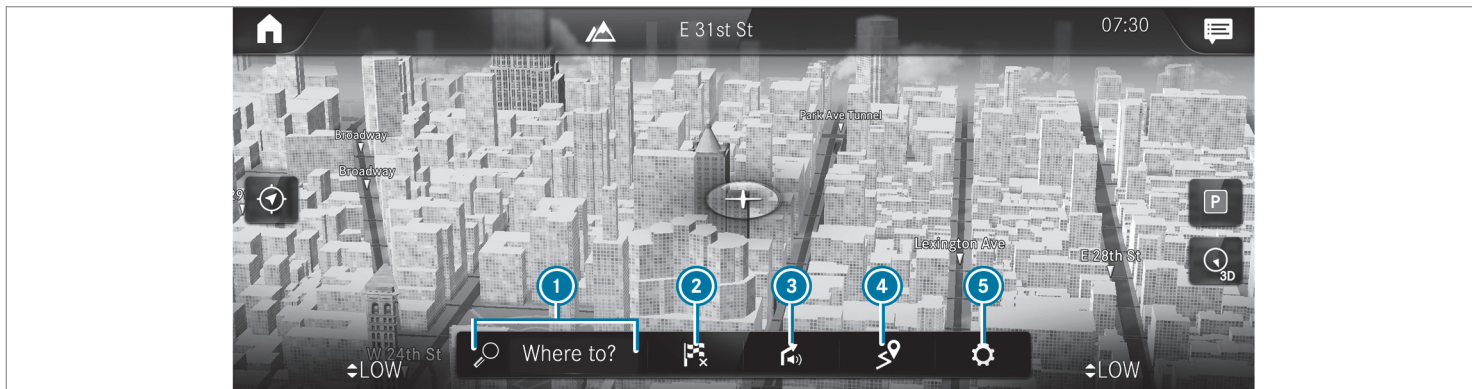

Example: digital map with navigation menu

- ① To enter a POI or address and additional destination entry options
- ② To cancel active route guidance
- ③ Repeats a navigation announcement and switch navigation announcements on or off

- ④ **ON THE WAY** menu with **Route Overview**, **Alternative Routes** and **Report Traffic Incident (Car-to-X)**  
**TRAFFIC** menu with **Traffic Announcements**, **Area Alerts** and **Live Traffic Subscription Info** To display **Route List**

**POSITION** menu with **Save Position** and **Compass**

- ⑤ Quick access for **Traffic**, **Parking** and **Highway Information** as well as options for **View**, **Announcements** and **Route via Advanced**

## Entering a destination

Multimedia system:

→ Home ▶ Navigation ▶ 🔍 Where to?

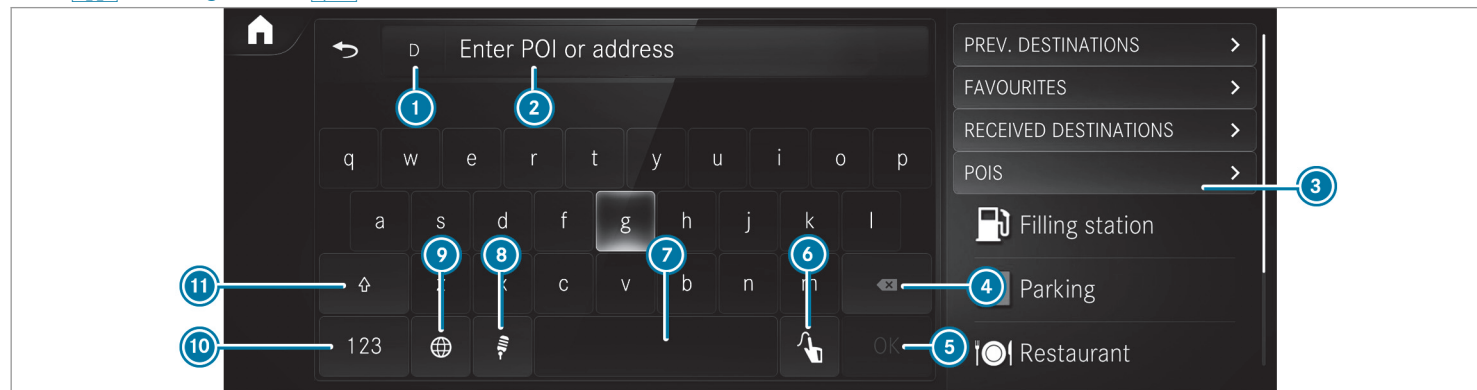

- ① The federal state or province in which the vehicle is located
- ② Enters a POI or address
- ③ List with additional destination entry options
- ④ Deletes an entry
- ⑤ **OK** Confirms an entry
- ⑥ Switches to handwriting recognition
- ⑦ Enters a space
- ⑧ Switches to voice input
- ⑨ Sets the written language
- ⑩ Switches to digits, special characters and symbols
- ⑪ Switches to upper-case or lower-case letters

- ▶ Enter the destination in ②. The entries can be made in any order.

The following entries can be made, for example:

- City, street, house number
- Street, city
- ZIP code
- POI name or POI category, e.g. [Parking](#)
- Contact name

- ▶ Select a search result in list ③. The route can be calculated.

**i** You can find further information about destination entry, e.g. 3 word addresses, in the Digital Operator's Manual.

### Changing country

- ▶ Select the indicator for federal state or province ①.
- ▶ Select the federal state or the province in ①.
- ▶ Enter the country indicator.
- ▶ Select the country on list ③.

- ▶ Select the federal state or the province from list ③.

### Using online search

Destination entry uses online map services. If the on-board search finds no suitable destinations or if you change countries, the online search is available.

For the destination you can enter an address, a POI or a 3 word address.

- ▶ Select country indicator ①.
- ▶ Select the provider for the online service from the countries list.

or

- ▶ If the on-board search delivers no results, enter the destination in input line ②.
- ▶ Select the destination in the list. The detailed view for the route is displayed.

### Calculating a route and using settings for route guidance

#### Requirements:





- The destination has been entered.

- The destination address is shown.

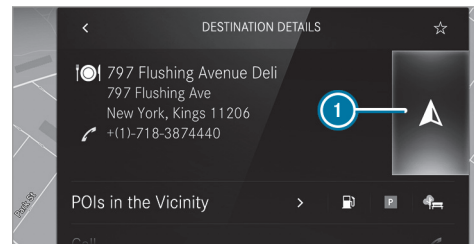
Multimedia system:

→  ▶ [Navigation](#)





- ①  No route yet.
-  A route has been mapped.
- ▶ Select . The route to the destination is calculated. Route guidance begins.
- or
- ▶ Select .

- ▶ Select **Set as Waypoint**.  
The destination address is set as the next intermediate destination.

or

- ▶ Select **Start New Route Guidance**.  
The destination address is set as the new destination. The previous destination and the intermediate destinations are deleted. Route guidance to the new destination begins.

### Selecting route settings

- ▶ Select .
- ▶ Select **Advanced**.
- ▶ Select **Route**.
- ▶ Select the route type.
- ▶ Take traffic information into consideration with **Dynamic Route Guidance** .
- ▶ Select route options with **Avoid Options**.
- ▶ Activate **Suggest Alternative Route**.  
Alternative routes are calculated for every route.

- ▶ Activate **Activate Commuter Route**.  
If the requirements are met, the multimedia system automatically detects that the vehicle is on a commuter route. Route guidance begins without voice output.

### Activating route guidance with augmented reality

- ▶ During route guidance, tap on the camera symbol on the media display.  
The camera image will be shown instead of the navigation map before a turning maneuver and will show additional information.
- ▶ **To return to the navigation map:** tap on the camera symbol again.

### Displaying additional information in the camera image

- ▶ Select .
- ▶ Select **Advanced**.
- ▶ Select **Augmented Reality**.
- ▶ Activate **Street Names** and **House Numbers**.  
During route guidance, street names and house numbers are shown in the camera image.

## Using map functions

Multimedia system:

  **▶▶ Navigation**

### Setting the map scale

- ▶ **To zoom in:** tap twice quickly with one finger on the media display.
- ▶ **To zoom out:** tap with two fingers on the media display.

### Moving the map

- ▶ Move one finger in any direction on the touchscreen.
- ▶ **To reset the map to the current vehicle position:** press  briefly.

### Selecting map orientation

- ▶ Tap repeatedly on the  compass symbol on the map.  
The view changes in the sequence **3D**, **2D Heading Up** to **2D North Up**.

### Switching freeway information on/off

- ▶ Select .

- ▶ Switch [Highway Information](#) on or off.

## Using services

### Requirements:

- There is an Internet connection.
- Mercedes me connect is available.
- You have set up a user account in the Mercedes me Portal.
- The vehicle is connected to a user account and you have accepted the conditions of use for the service.

Further information can be found at:  
<https://www.mercedes.me>

- The service is available.
- The service has been activated at an authorized Mercedes-Benz Center.

Multimedia system:

➔  ➔ [Navigation](#)

### Displaying the traffic situation with Live Traffic Information

- ▶ Select .
- ▶ Activate [Traffic](#).
- ▶ Select [Advanced](#).
- ▶ Select [View](#).
- ▶ Select [Map Elements](#).
- ▶ Switch on [Traffic Incidents](#), [Free Flowing Traffic](#) and [Delay](#).

If traffic information has been received, then traffic incidents such as roadworks, road blocks, local area reports (e.g. fog) and warning messages are displayed.

The traffic delay is displayed for the current route. Traffic delays lasting one minute or longer are taken into consideration.

### Displaying hazard warnings with Car-to-X-Communication

If hazard warnings are available these can be shown as symbols on the map. The display

depends on the settings for the [Traffic](#) and [Traffic Incidents](#) options.

- ▶ Set the options.  
If [Traffic](#) is switched off and [Traffic Incidents](#) is switched on, the symbols are shown on the prospective route.

### Displaying weather information and other map contents

- ▶ Select .
- ▶ Select [Advanced](#).
- ▶ Select [View](#).
- ▶ Select [Map Elements](#).
- ▶ Scroll up and show the [ONLINE MAP CONTENT](#) category.
- ▶ Switch on a service, e.g. [Weather](#).  
Current weather information is displayed on the navigation map, e.g. temperature or cloud cover.

## Telephone

### Telephony

#### Notes on telephony

**⚠ WARNING** Risk of distraction from operating integrated communication equipment while the vehicle is in motion

If you operate communication equipment integrated in the vehicle when driving, you will be distracted from the traffic situation. This could also cause you to lose control of the vehicle.

- ▶ Only operate this equipment when the traffic situation permits.
- ▶ If you cannot be sure of this, stop the vehicle whilst paying attention to road and traffic conditions and operate the equipment with the vehicle stationary.

**⚠ WARNING** Risk of an accident from operating mobile communication equipment while the vehicle is in motion

Mobile communications devices distract the driver from the traffic situation. This could also cause the driver to lose control of the vehicle.

- ▶ As the driver, only operate mobile communications devices when the vehicle is stationary.
- ▶ As a vehicle occupant, only use mobile communications devices in the areas intended for this purpose, e.g. in the rear passenger compartment.

You must observe the legal requirements for the country in which you are currently driving when operating mobile communication equipment in the vehicle.

**⚠ WARNING** Risk of injury due to objects being stowed incorrectly

If objects in the vehicle interior are stowed incorrectly, they can slide or be thrown around and hit vehicle occupants. In addition, cup holders, open stowage spaces and mobile phone receptacles cannot always retain all objects within.

There is a risk of injury, particularly in the event of sudden braking or a sudden change in direction.

- ▶ Always stow objects so that they cannot be thrown around in such situations.
- ▶ Always make sure that objects do not protrude from stowage spaces, parcel nets or stowage nets.
- ▶ Close the lockable stowage spaces before starting a journey.
- ▶ Always stow and secure heavy, hard, pointed, sharp-edged, fragile or bulky objects in the trunk/cargo compartment.

Observe the additional information on stowing mobile communications devices correctly:

- Loading the vehicle (→ page 102)

#### **Bluetooth® connection:**

The menu view and the available functions in the telephone menu are in part dependent on the Bluetooth® profile of the connected mobile phone. Full functionality is only available if the mobile phone supports both of the following Bluetooth® profiles:

- PBAP (Phone Book Access Profile)
  - The contacts on the mobile phone are shown automatically on the multimedia system.
- MAP (Message Access Profile)
  - The mobile phone message functions can be used on the multimedia system.

Irrespective of this, Bluetooth® audio functionality can be used with any mobile radio unit.

For information on the range of functions of the mobile radio unit to be connected, see the manufacturer's operating instructions.

#### **Network connection:**

The following cases can lead to the call being disconnected while the vehicle is in motion:

- You switch into a transmission/reception station, in which no communication channel is free.
- The SIM card used is not compatible with the network available
- a mobile phone with "Twincard" is logged into the network with the second SIM card at the same time

The multimedia system supports calls in HD Voice® for improved speech quality. A requirement for this is that the mobile phone and the mobile phone network provider of the person you are calling support HD Voice®.

Depending on the quality of the connection, the voice quality may fluctuate.

Further information can be obtained from an authorized Mercedes-Benz Center or at:  
<https://www.mercedes-benz.com/connect>

### Telephone menu overview

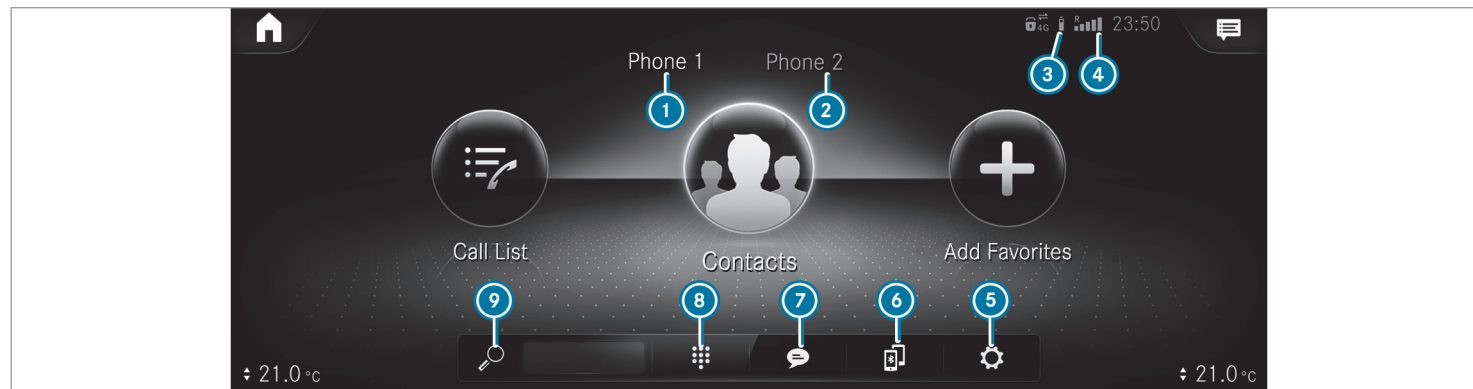

- ① Bluetooth® device name of the currently connected mobile phone/of the mobile phone
- ② Bluetooth® device name of the currently connected mobile phone/of the mobile phone (two phone mode)
- ③ Battery status of the connected mobile phone

- ④ Signal strength of the mobile phone network
- ⑤ Options
- ⑥ Device manager
- ⑦ Messages
- ⑧ Numerical pad
- ⑨ Contact search

### Telephony operating modes overview

Depending on your equipment, the following telephony operating modes are available:

- A mobile phone is connected to the multimedia system via Bluetooth®.



- Two mobile phones are connected with the multimedia system via Bluetooth® (two phone mode).
  - You can use all the functions of the multimedia system with the mobile phone in the foreground.
  - You can receive incoming calls and messages with the mobile phone in the background.

You can interchange the mobile phone in the foreground and background.

### Connecting a mobile phone

#### Requirements:

- Bluetooth® is activated on the mobile phone (see the manufacturer's operating instructions).
- Bluetooth® is activated on the multimedia system.

Multimedia system:



### Searching for a mobile phone

- ▶ Select .
- ▶ Select [Connect New Device](#).



### Connecting a mobile phone

Authorization follows using secure simple pairing.

- ▶ Select a mobile phone.  
A code is displayed in the multimedia system and on the mobile phone.
- ▶ If both codes match, confirm the code on the mobile phone.

### Functions in the telephony menu

In the telephony menu you have the following functions, for example:

- Making calls, e.g.:
  -  Accept a call
  -  [End Call](#)
  -  [Create Conf. Call](#)
  - Accepting or rejecting a waiting call

- Managing contacts, e.g.:
  - Downloading mobile phone contacts
  - Managing the format of a contact's name
  - Saving a contact as a favorite
- Receiving and sending messages, e.g.:
  - Using the read-aloud function
  - Dictating a new message

## Mercedes me and apps

### Mercedes me connect

#### Information on Mercedes me connect

Mercedes me connect consists of multiple services.

You can use the following services via the multimedia system and the overhead control panel, for example:

- Accident and Breakdown Management (me button or situation-dependent display in the multimedia system)
- Concierge Service (me button), if activated

- Mercedes-Benz emergency call system (automatic emergency call and SOS button)

Mercedes me connect Accident and Breakdown Management, the Mercedes me connect Concierge Service (if service is activated) and the Mercedes-Benz emergency call center are available for you around the clock.

The me button and the SOS button can be found on the vehicle's overhead control panel (→ page 271).

You can also call the Mercedes-Benz Customer Center using the multimedia system (→ page 272).

Please note that Mercedes me connect is a Mercedes-Benz service. In emergencies, first call the national emergency services using the standard national emergency service telephone numbers. In emergencies, you can also use the Mercedes-Benz emergency call system (→ page 277).

Observe the conditions of use for Mercedes me connect and other services. These can be obtained in the Mercedes me Portal: <https://me.secure.mercedes-benz.com>

Further information about Mercedes me connect services can be obtained in the Mercedes me Portal: <https://me.secure.mercedes-benz.com>

### **Information on Mercedes me connect Accident and Breakdown Management**

The Accident and Breakdown Management can include the following functions:

- Supplement to the Mercedes-Benz emergency call system (→ page 277)  
If necessary, the contact person at the Mercedes-Benz emergency call center forwards the call to Mercedes me connect Accident and Breakdown Management. Forwarding the call is however not possible in all countries.
- Breakdown assistance by a technician on location and/or the towing away of the vehicle to the nearest authorized Mercedes-Benz Center  
You may be charged for these services.
- Addition to the emergency guide after automatic accident or breakdown detection (→ page 272)

In the event of a breakdown or accident, further vehicle data is sent which enables optimal support by the Mercedes-Benz Customer Center and the authorized service partner or breakdown assistance.

- Addition to the Mercedes me connect service Telediagnosics

With the Telediagnosics function, specific wear and failure reports are recorded by the service provider, in so far as these can be clearly interpreted and are available through the monitoring of components that are subject to diagnostics.

If your vehicle detects a breakdown or threat of a breakdown, you may be prompted via the multimedia system to contact the Mercedes-Benz Customer Center for further help. This prompt in the multimedia system only appears when the vehicle is stationary.

**i** These services are subject to technical restrictions such as the mobile phone coverage, mobile network quality and the ability of the processing systems to interpret the transferred data. In some circumstances, this can result in delays or the failure of the information to appear in the multimedia system.

More information about Mercedes me connect services can be obtained in the Mercedes me Portal: <https://me.secure.mercedes-benz.com>

### Data transferred during Mercedes me connect call services

The data transferred during a Mercedes me connect call depends on:

- The reason for initiation of the call
- The service that is selected in the voice control system
- The activated Mercedes me connect services

Which data is transferred for the services can be taken from the currently valid terms of use. These can be obtained in the Mercedes me portal: <https://me.secure.mercedes-benz.com>

## Mercedes me calls

### Making a call via the overhead control panel

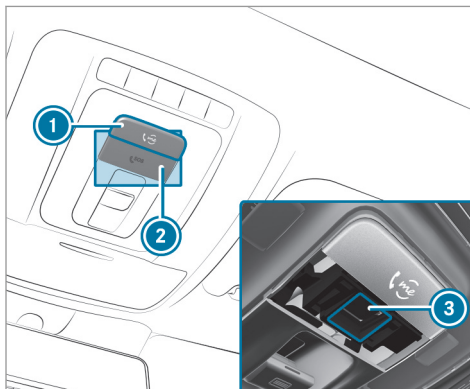

- ① me button for service, concierge or information calls
- ② SOS button cover
- ③ SOS button (emergency call system)

▶ **To make a Mercedes me call:** press me button ①.

▶ **To make an emergency call:** press SOS button cover ② briefly to open.

▶ Press and hold SOS button ③ for at least one second.

If a Mercedes me call is active, an emergency call can still be triggered. This has priority over all other active calls.

### Information about the Mercedes me call using the me button

A call to the Mercedes-Benz Customer Center has been initiated via the me button in the overhead control panel or the multimedia system (→ page 271).

Using the voice dialog system you access the desired service:

- Concierge Service (if the service is activated)
- Accident and Breakdown Management
- Mercedes-Benz Customer Center for general information about the vehicle

You can find information on the following topics:

- Activation of Mercedes me connect
- Operating the vehicle
- Nearest authorized Mercedes-Benz Center
- Other products and services from Mercedes-Benz

Data is transferred during the connection to the Mercedes-Benz Customer Center (→ page 273).

### Calling the Mercedes-Benz Customer Center using the multimedia system

#### Requirements:

- Access to a GSM network is available.
- The contract partner's GSM network coverage is available in the respective region.
- The ignition must be switched on so that vehicle data can be transferred automatically.

Multimedia system:



#### ▶ Call Mercedes me connect.

After confirmation, the multimedia system sends the required vehicle data. The data transfer is shown in the media display.

Then, you can select a service and be connected to a specialist at the Mercedes-Benz Customer Center.

- ⓘ In some countries, or if the Concierge Service is active, you will be connected directly with the Mercedes-Benz Customer Center. The Concierge Service is not available in all countries. More information about Mercedes me connect services can be obtained in the Mercedes me Portal: <https://me.secure.mercedes-benz.com>

### Calling the Mercedes-Benz Customer Center after automatic accident or breakdown detection

#### Requirements:

- The vehicle has detected an accident or breakdown situation.
- The vehicle is stationary.
- The hazard warning lights are switched on.

ⓘ This function is not available in all countries. The vehicle can detect accident or breakdown situations under certain circumstances.

In the event an accident or breakdown is detected, the emergency guide shows safety notes in the multimedia system display.

After quitting the emergency guide display on the multimedia system, a prompt appears asking whether you wish to get support from the Mercedes-Benz Customer Center.

#### ▶ Select Call.

- After your agreement, or if the Mercedes me connect service "Accident and Breakdown Management" is active, the vehicle data is transferred automatically (→ page 270).
- The Mercedes-Benz Customer Center takes your call and organizes the breakdown and accident assistance.

■ You may be charged for these services.

- ① Depending on the severity of the accident, an automatic emergency call can be initiated. This has priority over all other active calls.
- ① In addition, if the Mercedes me connect service "Telediagnosics" is active, a similar prompt can appear after a delay in the event of a breakdown. If you are already in contact with the Mercedes-Benz Customer Center or have already received support, this prompt can be ignored or declined.
- ① If you answer the prompt for support from the Mercedes-Benz Customer Center with **Later**, the message will be hidden and appear again later.  
The prompt triggered by the Mercedes me connect service "Telediagnosics", can either be confirmed or declined. After being declined, this will not be shown again.

### Arranging a service appointment via a Mercedes me call

If you have activated the maintenance management service, relevant vehicle data is transferred

automatically to the Mercedes-Benz Customer Center. You will then receive individual recommendations regarding the maintenance of your vehicle.

Regardless of whether you have consented to the maintenance management service, the multimedia system reminds you after a certain amount of time that a service is due. A prompt appears asking if you would like to make an appointment.

▶ **To arrange a service appointment:** select **Call**.

After your agreement, the vehicle data is transferred and the Mercedes-Benz Customer Center takes your preferred appointment date. The information is then sent to your desired service outlet.

This will contact you to confirm the appointment and if necessary consult about the details.

- ① If you select **Later** after the service message appears, the message is hidden and reappears at a later time.

### Transferred data during a Mercedes me call

If you initiate a service call using Mercedes me, data is transferred to enable targeted advice and an efficient service.

The following requirements must be fulfilled for the transfer of the data:

- The ignition is switched on.
- The required data transfer technology is supported by the mobile service operator.
- The quality of the mobile connection is sufficient.

Multi-stage transfer depends on the following factors:

- Reason for the initiation of the call
- The available mobile phone transmission technology.
- The activated Mercedes me connect services.
- The service selected in the voice control system.

### Data transfer if Mercedes me connect services are not activated

If no Mercedes me connect services are activated, the following data is transferred:

- Vehicle identification number
- Time of the call
- Reason for the initiation of the call
- Confirmation of the data protection prompt
- Country indicator of the vehicle
- Set language for the multimedia system
- Telephone number of the communication platform installed in the vehicle

If a call is made for a service appointment via the service reminder, the following data is also transmitted:

- Current mileage and maintenance data

If a call is made after automatic accident or breakdown detection using the multimedia system, the following data is also transmitted:

- Current mileage and maintenance data
- Current vehicle location

If Accident and Breakdown Management is called via the voice control system, the following data can also be called up from the vehicle by the Mercedes-Benz Customer Center:

- Current vehicle location

### Data transfer if Mercedes me connect services are activated

Only if the respective service is activated will additional incident-specific data be transmitted in the second stage to enable an optimal service.

An overview of the data transmitted can be found in the respective terms of use for Mercedes me connect services. These can be obtained in the Mercedes me Portal: <https://me.secure.mercedes-benz.com>

### Data processing

The data transmitted within the scope of the call is deleted from the processing system after the call is finished, in so far as this data is not being used for other activated Mercedes me connect services.

The incident-specific data is processed and stored in the Mercedes-Benz Customer Center

and, if required to process the incident, forwarded to the service partner authorized by the Mercedes-Benz Customer Center. Please take note of the data protection information on the Mercedes me Internet page at <https://www.mercedes.me> or in the recorded message immediately after calling the Mercedes-Benz Customer Center.

- ① The recorded message is not available in every country.

### Overview of the Mercedes me & Apps menu

When you log in with a user account to the Mercedes me Portal, then services and offers from Mercedes-Benz will be available to you.

For more information consult an authorized Mercedes-Benz Center or visit the Mercedes me portal: <https://me.secure.mercedes-benz.com>

- ① Make sure you always keep the Mercedes me apps updated.

You can call up the menu using **Mercedes me & Apps** in the multimedia system.

In the [Mercedes me & Apps](#) menu, the following options can be available:

- Connecting the vehicle with the [Mercedes me](#) user account
- Deleting a connection between a [Mercedes me](#) user account and the vehicle
- Calling up the Mercedes me services
- Calling up apps such as, In-Car Office or the web browser depending on availability

### [Web browser overview](#)

The web browser is started using the [Mercedes me & Apps](#) menu.

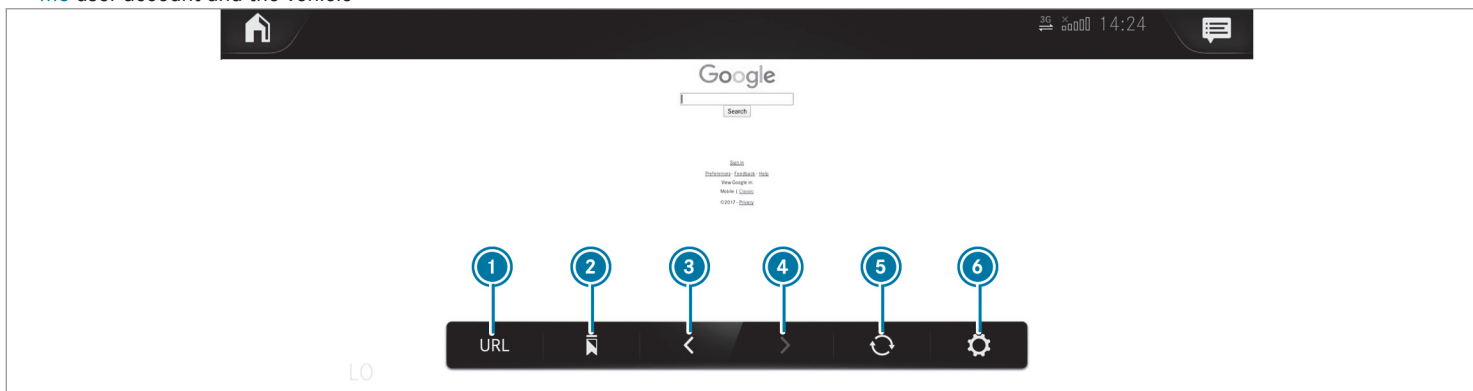

- ① URL entry
- ② Bookmarks
- ③ Web page, back

- ④ Web page, forwards
- ⑤ To refresh/stop
- ⑥ Options

- ⓘ Websites cannot be shown while the vehicle is in motion.

## Smartphone integration

With Smartphone Integration, you can use certain functions on your mobile phone via the multimedia system display.

Only one mobile phone at a time can be connected via Smartphone Integration to the multimedia system. Also for use with two phone mode with smartphone integration, only one additional mobile phone can be connected using Bluetooth® with the multimedia system.

The full range of functions for Smartphone Integration is only possible with an Internet connection. The appropriate application must be downloaded on the mobile phone to use Smartphone Integration. The mobile phone must be switched on and connected to a USB port with the  symbol on the multimedia system using a suitable cable.

### Apps for Smartphone Integration

- Mercedes-Benz Link (implementation of the function using the Mercedes-Benz Link control box)
- Apple CarPlay®

- Android Auto

You can start Smartphone Integration using the **Mercedes me & Apps** menu.

You can end Smartphone Integration by disconnecting the connecting cable between the mobile phone and multimedia system.

### Overview of transferred vehicle data

When using Smartphone Integration, certain vehicle data is transferred to the mobile phone. This enables you to get the best out of selected mobile phone services. Vehicle data is not directly accessible.

The following system information is transmitted:

- Software release of the multimedia system
- System ID (anonymized)

The transfer of this data is used to alter how content is displayed to correspond to the driving situation.

The following position data is transmitted:

- Coordinates
- Speed

- Compass direction
- Acceleration direction

This data is used by the mobile phone to improve the accuracy of the navigation (e.g. for continuation in a tunnel).

## Mercedes-Benz emergency call system

### Information on the Mercedes-Benz emergency call system

Your vehicle is equipped with the Mercedes-Benz emergency call system ("eCall"). This feature can help save lives in the event of an accident. eCall in no way replaces assistance provided from dialing 911.

Mercedes-Benz eCall only functions in areas where mobile phone coverage is available from the wireless service providers. Insufficient network coverage from the wireless service providers may result in an emergency call not being transmitted.

eCall is a standard feature in your Mercedes-Benz vehicle. In order to function as intended, the system relies on the transmission of data



detailed in the "Mercedes-Benz emergency call system data transmission" section that follows (→ page 279).

To disable eCall, a customer must visit an authorized Mercedes-Benz Service department to deactivate the vehicle's communication module.

**Deactivation of this module prevents the activation of any and all Mercedes me connect services. After the deactivation of eCall, automatic emergency call and manual emergency call will not be available.**

The ignition must be switched on before an automatic emergency call can be made.

- ❗ eCall is activated at the factory.
- ❗ eCall can be deactivated by an authorized Mercedes-Benz dealer. Please note that in the event ownership of the vehicle is transferred to another owner in its deactivated state, eCall will remain deactivated unless the new owner visits an authorized Mercedes-Benz dealership to reactivate the system.

### Overview of the Mercedes-Benz emergency call system

eCall can help to reduce the time between an accident and the arrival of emergency services at the site of the accident. It helps locate an accident site in places that are difficult to access. However, even if a vehicle is equipped with eCall, this does not mean the system is ON. As such, eCall does not replace dialing 911 in the event of an accident.

An emergency call can be made automatically (→ page 277) or manually (→ page 278) Only make emergency calls if you or others are in need of rescue.

Only make emergency calls if you or others are in need of rescue. Do not make an emergency call in the event of a breakdown or a similar situation.

#### Messages on the display

**SOS NOT READY:** the ignition is not on or eCall not available.

During an active emergency call,  appears in the display.

You can find more information on the regional availability of eCall at: <https://www.mercedes-benz-mobile.com/extra/ecall/>

- ❗ If there is a malfunction in the Mercedes-Benz emergency call system (e.g. a fault with the speaker, microphone, airbag, SOS button), a corresponding message appears in the multifunction display of the instrument cluster.

### Triggering an automatic Mercedes-Benz emergency call

#### Requirements:

- The ignition is switched on.
- The starter battery is sufficiently charged.

The Mercedes-Benz emergency call system triggers an emergency call automatically in the following cases:

- After activation of the restraint systems such as airbags or Emergency Tensioning Devices after an accident
- After an automatically initiated emergency stop by Active Emergency Stop Assist

The emergency call has been made:

- A voice connection is made to the Mercedes-Benz emergency call center.
- A message with accident data is transmitted to the Mercedes-Benz emergency call center.

The Mercedes-Benz emergency call center can transmit the vehicle position data to one of the emergency call centers.

The SOS button in the overhead control panel flashes until the emergency call is finished.

It is not possible to immediately end an automatic emergency call.

If no connection can be made to the emergency services either, a corresponding message appears in the media display.

- ▶ Dial the local emergency number on your mobile phone.

If an emergency call has been initiated:

- Remain in the vehicle if the road and traffic conditions permit you to do so until a voice connection is established with the emergency call center operator.

- Based on the call, the operator decides whether it is necessary to call rescue teams and/or the police to the accident site.
- If no vehicle occupant answers, an ambulance is sent to the vehicle immediately.

### Triggering a manual Mercedes-Benz emergency call

- ▶ **To use the SOS button in the overhead control panel:** press and hold the SOS button for at least one second (→ page 271).
- ▶ **To use the voice control system:** use the Voice Control System voice commands .

The emergency call has been made:

- A voice connection is made to the Mercedes-Benz emergency call center.
- A message with accident data is transmitted to the Mercedes-Benz emergency call center.

The Mercedes-Benz emergency call center can transmit the vehicle position data to one of the emergency call centers.

- Remain in the vehicle if the road and traffic conditions permit you to do so until a voice connection is established with the emergency call center operator.
- Based on the call, the operator decides whether it is necessary to call rescue teams and/or the police to the accident site.

If no connection can be made to the emergency services either, a corresponding message appears in the media display.

- ▶ Dial the local emergency number on your mobile phone.

### Ending an unintentionally triggered manual Mercedes-Benz emergency call

- ▶ **On the multifunction steering wheel:** select . Depress the button for several seconds.

### Data transfer of the Mercedes-Benz emergency call system

In the event of an automatic or manual emergency call the following data is transmitted, for example:

- Vehicle's GPS position data
- GPS position data on the route ( a few hundred meters )before the incident)
- Direction of travel
- Vehicle identification number
- Vehicle drive type
- Number of people determined to be in the vehicle
- Whether Mercedes me connect is available or not
- Whether the emergency call was initiated manually or automatically
- Time of the accident
- Language setting on the multimedia system

Data transmitted is vehicle information. For any questions about the collection, use and sharing of the eCall system data, please contact MBU-

SA's Customer Assistance Center at 800-FOR-MERC.

For Canada, please contact MBC's Customer Assistance Center at 1-800-387-0100.









Customer requests for covered information should be submitted via the same channels.





For accident clarification purposes, the following measures can be taken up to an hour after the emergency call has been initiated:

- The current vehicle position can be determined.
- A voice connection to the vehicle occupants can be established.

## Radio &amp; media

## Overview of the symbols and functions in the media menu

Symbol	Designation	Function
	Play	Select to start or continue playback.
	Rest	Select to pause the playback.
	Repeating a track	Select to repeat the current track or the active playlist. <ul style="list-style-type: none"> <li>• Select once: the active playlist is repeated.</li> <li>• Select twice: the current track is repeated.</li> <li>• Select three times: the function is deactivated.</li> </ul>
	Random playback	Select to play back tracks in random order.
	Skip forwards/back	Select to skip to the next or to the previous track.
	Options	Select to show additional options.
	Categories	Select to show or search through available categories (e.g. playback lists, albums, artists, etc.).
	Search	Select to search in the active menu. You can search for artists, genres, moods or videos, for example.

Symbol	Designation	Function
	Settings	Select to make settings.
	Home	Select to return to the home screen.
	Messaging	Select to call up messaging.
	Full screen	Select to switch to full screen mode

**The following functions and settings are available in the media menu:**

- Connecting external data storage media with the multimedia system (e.g. using USB or Bluetooth®)
- Playing back audio or video files

### Authorizing a Bluetooth® audio device for media playback

**Requirements:**

- Bluetooth® is activated on the multimedia system and audio equipment.

- The audio equipment supports the Bluetooth® audio profiles A2DP and AVRCP.
- The audio equipment is "visible" for other devices.

Multimedia system:



With Bluetooth® audio, you can play back music files from an external data storage medium, e.g. your smartphone, using the MBUX multimedia system.

- ▶ To play back audio files using the multimedia system, authorize the external data storage medium on the MBUX multimedia system.





### Authorizing a new Bluetooth® audio device





- ▶ Select **Connect New Device**.
- ▶ Select an audio device. Authorization starts. A code is displayed on the multimedia system and on the mobile phone.
- ▶ If the codes are identical, confirm on the audio equipment.
- ▶ Select **Only as Bluetooth Audio Device**. The Bluetooth® audio equipment is connected with the multimedia system.

### Connecting previously authorized Bluetooth® audio equipment

- ▶ Select a Bluetooth® audio device from the list.  
The connection is being established.

### Overview of the symbols and functions in the radio menu

Symbol	Designation	Function
	Home	Select to return to the home screen.
	Messaging	Select to call up messaging.
	Skip forwards/back	Select to skip to the next or to the previous station.
	Options	Select to have further options shown. Settings can be made to the following additional functions, for example: <ul style="list-style-type: none"><li>• Navigation and traffic announcements</li><li>• Frequency Fix function</li><li>• Radio additional text</li><li>• Emergency warnings</li></ul> The setting options are country-dependent.

Symbol	Designation	Function
HD	HD radio	Select to switch the HD radio function on or off. This function is not available in all countries.
	Mute function	Select to switch off the sound
	Storing radio stations	Select to save a station in the presets
	Station list	Select to have the station list shown.
	Search	Select to search in the active menu. You can search for artists, genres, moods or videos, for example.

#### Additional functions of Tuneln Radio

-  A relatively large volume of data can be transmitted when using Tuneln Radio.

Symbol	Designation	Function
	Options	The following additional settings are available in the TuneIn Radio menu: <ul style="list-style-type: none"> <li>• Selecting stream</li> <li>• Logging on to/out of the TuneIn account</li> </ul>
	Favorites	Select during playback to save the station currently set as a favorite.
	Play/Stop	Select to start, stop or continue playback.
	Browse	Select to choose a category and then a radio station.





#### Additional functions of the satellite radio

SIRIUS XM® satellite radio offers more than 175 digital-quality radio channels providing 100% commercial-free music, sports, news and entertainment, for example. SIRIUS XM® satellite radio employs a fleet of high-performance satel-

lites to broadcast around the clock throughout the USA and Canada. The satellite radio program is available for a monthly fee. Information about this can be obtained from a Sirius XM® Service Center and at <https://www.siriusxm.com> (USA) or <https://www.siriusxm.ca> (Canada).

 Sirius, XM and all related marks and logos are trademarks of Sirius XM Radio Inc. and its subsidiaries. All other marks, channel names and logos are the property of their respective owners. All rights reserved.



Symbol	Designation	Function
	Options	The following additional settings are available in the satellite radio menu: <ul style="list-style-type: none"> <li>• Activate parental control to lock channels with adult content</li> <li>• Set alarm programming for music and sport alerts</li> <li>• Create TuneMix lists to listen to music seamlessly</li> </ul>
	Playback controls	Select to show the timeline. Tap any point on the timeline to skip forwards or back. Navigate to the end of the timeline to return to live mode.
	Play	Select to start or continue playback.
	Rest	Select to pause the playback.

Depending on the frequency band selected, different functions are available to you.

Select the desired frequency band in the radio menu head runner.

### Calling up TuneIn Radio

#### Requirements:

- The Tuneln Radio service is activated in the Mercedes me portal.
- The data volume is available.  
Depending on the country, data volume may need to be purchased.
- A fast Internet connection for data transmission free of interference.

- ① New data volume can be purchased **directly from a mobile phone network provider** via the Mercedes me Portal.
- ① The functions and services are country-dependent. For more information, consult an authorized Mercedes-Benz Center.

Multimedia system:

 **▶▶ Radio**

- ▶ Select **Tuneln Radio**.  
The Tuneln menu appears. The last station set starts playing.
- ① The connection quality depends on the local mobile phone reception.

## Setting up satellite radio

### Requirements:

- Satellite radio equipment is available.
- Registration with a satellite radio provider has been completed.
- If registration is not included when purchasing the system, your credit card details will be required to activate your account.

Multimedia system:

 **▶▶ Radio ▶▶ SiriusXM**  
**▶▶  Options**

- ▶ Select **Service Information**.  
The service information screen appears showing the radio ID and the current subscription status.
- ▶ Establish a telephone connection.
- ▶ Follow the service staff's instructions.  
The activation process may take up to ten minutes.
- ① You can also have the satellite service activated online. To do so, please visit <http://www.siriusxm.com> (USA) or <http://www.siriusxm.ca> (Canada).

[www.siriusxm.com](http://www.siriusxm.com) (USA) or <http://www.siriusxm.ca> (Canada).

## Music and sport alerts

Multimedia system:

 **▶▶ Radio ▶▶ SiriusXM ▶▶ **  
**▶▶ Alerts**

### Setting music and sport alerts

This function enables you to program an alert for your favorite artists, tracks or sporting events. Music alerts can be saved whilst a track is being played and sport alerts can be saved during a live game. You can also specify sport alerts via the menu option. The system then continuously searches through all the channels.

- ▶ Set a music or sports alert, to be informed of matches in the Live program.

### Activating the music information function

- ▶ Activate **Music Alerts** .

### Setting a music alert

- ▶ Select **Add Alert**.

- ▶ Select **Artists** or **Song** in the dialog window. The alert is set for the current artist or track. If a match is found, a prompt appears asking whether you wish to change to the station.

#### Activating sports information

- ▶ Activate **Activate Sports Alerts** .

#### Setting a sport alert

- ▶ Select **Add Alert**.
- ▶ Select the team name or league in the dialog window.

#### Deleting individual sports and music alerts

- ▶ Select **Manage Music Alerts**.

or

- ▶ Select **Manage Sports Alerts**.
- ▶ Select an artist or track.

or

- ▶ Select a team.
- ▶ Select **Delete Selected Entries**. All highlighted alerts are deleted.

#### Deleting all sports and music alerts

- ▶ Select **Manage Music Alerts**.

or

- ▶ Select **Manage Sports Alerts**.
- ▶ Select **Delete All Entries**. All alerts are deleted.

### Sound settings

#### Overview of functions in the sound menu

The setting options and functions available depend on the sound system installed. You can find out which sound system is installed in your vehicle in the Digital Operator's Manual.

#### Standard sound system and Advanced sound system

The following functions are available:

- Equalizer
  - Treble, mid-range and bass
- Balance and fader
- Volume
  - Automatic adjustment

#### Burmester® surround sound system and Burmester® high-end 3D surround sound system

The following functions are available:

- Equalizer
  - Treble, mid-range and bass
- Balance and fader
- Sound focus
- VIP seats (Burmester® high-end 3D surround sound system)
- Sound profiles
- Volume
  - Automatic adjustment

## ASSYST PLUS service interval display

### Function of the ASSYST PLUS service interval display

The ASSYST PLUS service interval display on the Instrument Display provides information on the remaining time or distance before the next service due date.

You can hide this service display using the back button on the left-hand side of the steering wheel.

Depending on how the vehicle is used, the ASSYST PLUS service interval display may shorten the service interval, e.g. in the following cases:

- Mainly short-distance driving
- When the engine is often left idling for long periods
- In the event of frequent cold start phases

Mercedes-Benz recommends avoiding such operating conditions.

You can obtain information concerning the servicing of your vehicle from a qualified specialist

workshop, e.g. an authorized Mercedes-Benz Center.

### Displaying the service due date

On-board computer:

↳ Service ► ASSYST PLUS

The next service due date is displayed.

► **To exit the display:** press the back button on the left-hand side of the steering wheel.

Bear in mind the following related topic:

- Operating the on-board computer (→ page 243).

### Information on regular maintenance work

**!** **NOTE** Premature wear through failure to observe service due dates

Service work which is not carried out at the right time or incompletely can lead to increased wear and damage to the vehicle.

- Always observe the prescribed service intervals.
- Always have the prescribed service work carried out at a qualified specialist workshop.

### Special service requirements

The prescribed service interval is based on normal operation of the vehicle. Maintenance work will need to be performed more often if the vehicle is operated under arduous conditions or increased loads.

The ASSYST PLUS service interval display is only an aid. The driver of the vehicle bears responsibility as regards to whether maintenance work needs to be performed more often than specified based on the actual operating conditions and/or loads.

Examples of arduous operating conditions:

- regular city driving with frequent intermediate stops
- mainly short-distance driving

- frequent operation in mountainous terrain or on poor road surfaces
- when the engine is often left idling for long periods
- operation in particularly dusty conditions and/or if air-recirculation mode is frequently used

In these or similar operating conditions, have the interior air filter, engine air cleaner, engine oil and oil filter etc. changed more frequently. The tires must be checked more frequently if the vehicle is operated under increased loads. Further information can be obtained at a qualified specialist workshop.

### Battery disconnection periods

**The ASSYST PLUS service interval display can only calculate the service due date when the battery is connected.**

- ▶ Note down the service due date displayed on the instrument display before disconnecting the battery (→ page 288).

## Engine compartment

### Opening/closing the hood

**⚠ WARNING** Risk of accident due to driving with the hood unlocked

The hood may open and block your view.

- ▶ Never release the hood when driving.
- ▶ Before every trip, ensure that the hood is locked.

**⚠ WARNING** Risk of accident and injury when opening and closing the hood

The hood may suddenly drop into the end position.

There is a risk of injury for anyone in the hood's range of movement.

- ▶ Open or close the hood only when there is nobody in the hood's range of movement.

**⚠ WARNING** Danger of burns when opening the hood

If you open the hood when the engine has overheated or during a fire in the engine compartment, you could come into contact with hot gases or other escaping operating fluids.

- ▶ Before opening the hood, allow the engine to cool down.
- ▶ In the event of a fire in the engine compartment, keep the hood closed and call the fire service.

**⚠ WARNING** Risk of injury due to moving parts

Components in the engine compartment may continue running or start up suddenly, even if the ignition is switched off.

Make sure of the following before performing tasks in the engine compartment:

- ▶ Switch the ignition off.

- ▶ Never reach into the danger zone surrounding moving components, e.g. the rotation area of the fan.
- ▶ Remove jewelry and watches.
- ▶ Keep items of clothing and hair away from moving parts.

**⚠ WARNING** Risk of injury from touching components under voltage

The ignition system and the fuel injection system work under high voltage. You could receive an electric shock.

- ▶ Never touch components of the ignition system or the fuel injection system when the ignition is switched on.

**⚠ WARNING** Risk of burns from hot component parts in the engine compartment

Certain components in the engine compartment can be very hot, e.g. the engine, the radiator and parts of the exhaust system.

- ▶ Allow the engine to cool down and only touch component parts described in the following.

**⚠ WARNING** Risk of injury from using the windshield wipers while the engine hood is open

When the engine hood is open and the windshield wipers are set in motion, you can be trapped by the wiper linkage.

- ▶ Always switch off the windshield wipers and ignition before opening the engine hood.

### Opens the hood

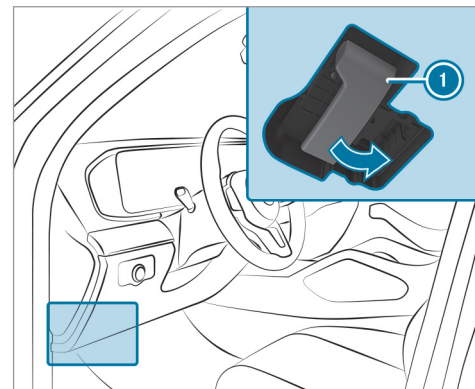

- ▶ To release the hood, pull on handle ①.

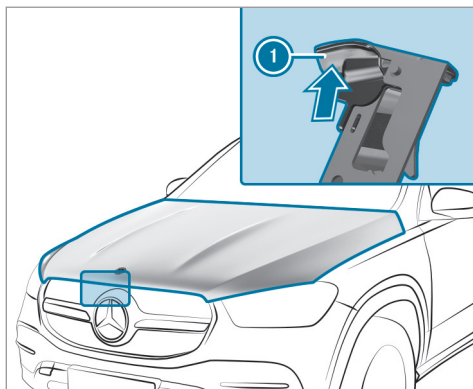

- ▶ Push handle ① of the hood catch upwards and lift the hood by approximately 15 in (40 cm).

### Closing the hood

#### **!** NOTE Damage to the hood

If the hood is closed manually, there is a risk of dents.

- ▶ Do not close the hood manually.

- ▶ Lower the hood to a height of around 8 in (20 cm) and then allow it to fall, applying a little force as you let it go.
- ▶ If the hood can still be lifted slightly, open the hood again and close it with a little more force until it engages correctly.

### Engine oil

#### Checking the engine oil level using the on-board computer

**Requirements:**

- The engine has been warmed up.
- The vehicle is parked on a level surface.
- The engine is running at idle speed.

The engine oil level is determined during driving. Determining the engine oil level can take up to 30 minutes with a normal driving style and even longer with an active driving style.

On-board computer:

#### ↳ Service ▶ Engine Oil Level

You will see one of the following messages on the multifunction display:

- **Measuring Engine Oil Level...:** measurement of the oil level is not yet possible.
- ▶ Repeat the request after a maximum of 30 minutes' driving.
- **Engine Oil Level OK** and the bar display for indicating the oil level on the multifunction display is green and is between "min" and "max": the oil level is correct.
- **Engine Oil Level Add 1,1 qts.** and the bar display for indicating the oil level on the multifunction display is orange and is below "min":
- ▶ Add 1.1 US qt (1 l) of engine oil.
- **Reduce Engine Oil Level** and the bar display for indicating the oil level on the multifunction display is orange and is above "max":

- ▶ Drain off any excess engine oil that has been added. To do so, consult a qualified specialist workshop.
- [For Engine Oil Level Switch Ignition On](#)
- ▶ Switch on the ignition to check the engine oil level.
- [Engine Oil Level System Inoperative](#): The oil level sensor is defective or not connected.
- ▶ Consult a qualified specialist workshop.
- [Engine Oil Level System Currently Unavail.](#)
- ▶ Close the hood.

### Refilling engine oil

**⚠ WARNING** Risk of burns from hot component parts in the engine compartment

Certain components in the engine compartment can be very hot, e.g. the engine, the radiator and parts of the exhaust system.

- ▶ Allow the engine to cool down and only touch component parts described in the following.

**⚠ WARNING** Risk of fire and injury from engine oil

If engine oil comes into contact with hot component parts in the engine compartment, it may ignite.

- ▶ Make sure that no engine oil is spilled next to the filler opening.
- ▶ Allow the engine to cool off and thoroughly clean the engine oil from component parts before starting the vehicle.

**! NOTE** Engine damage caused by an incorrect oil filter, incorrect oil or additives

- ▶ Do not use engine oils or oil filters which do not correspond to the specifications explicitly prescribed for the service intervals.
- ▶ Do not alter the engine oil or oil filter in order to achieve longer change intervals than prescribed.
- ▶ Do not use additives.

- ▶ Follow the instructions in the service interval display regarding the oil change.

**! NOTE** Damage caused by refilling too much engine oil

Too much engine oil can damage the engine or the catalytic converter.

- ▶ Have excess engine oil removed at a qualified specialist workshop.

- ⓘ Depending on the engine, the cap may be installed in the engine compartment in different locations.



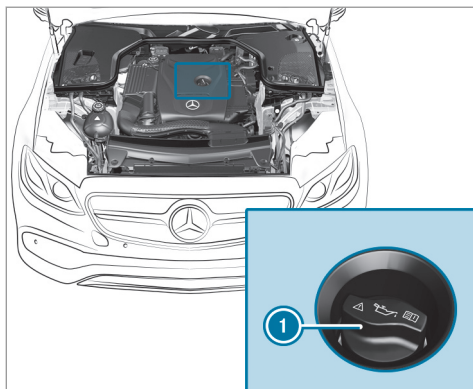

- ▶ Turn cap ① counter-clockwise and remove it.
- ▶ Add engine oil.
- ▶ Replace cap ① and turn it clockwise until it engages.
- ▶ Check the oil level again (→ page 291).

### Checking coolant level

**⚠ WARNING** Risk of burns from hot component parts in the engine compartment

Certain components in the engine compartment can be very hot, e.g. the engine, the radiator and parts of the exhaust system.

- ▶ Allow the engine to cool down and only touch component parts described in the following.

**⚠ WARNING** Risk of scalding from hot coolant

If you open the cap, you could be scalded.

- ▶ Let the motor cool down before opening the cap.
- ▶ When opening the cap, wear protective gloves and safety glasses.
- ▶ Open the cap slowly to release pressure.

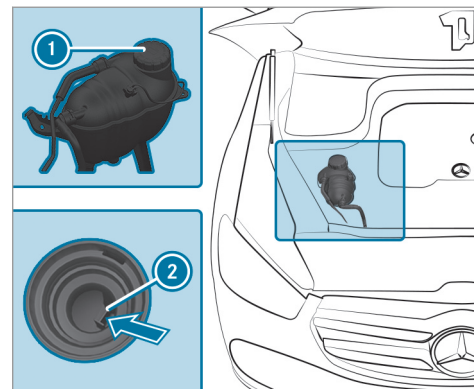

- ▶ Park the vehicle on a level surface.
- ▶ Check the coolant temperature display in the instrument cluster. The coolant temperature must be in the bottom quarter of the temperature display.
- ▶ Slowly turn cap ① counter-clockwise to release overpressure.

- ▶ Continue turning cap ① counter-clockwise and remove it.

The coolant level is correct in the following cases:

- if the engine is cold, the coolant is up to marker bar ②.
  - if the engine is warm, the coolant is up to 0.6 in (1.5 cm) over marker bar ②.
- ▶ If necessary, add coolant that has been approved for Mercedes-Benz.
- ① Further information on coolant (→ page 361)

### Adding washer fluid to the windshield washer system

**⚠ WARNING** Risk of burns from hot component parts in the engine compartment

Certain components in the engine compartment can be very hot, e.g. the engine, the radiator and parts of the exhaust system.

- ▶ Allow the engine to cool down and only touch component parts described in the following.

**⚠ WARNING** Danger of burns when opening the hood

If you open the hood when the engine has overheated or during a fire in the engine compartment, you could come into contact with hot gases or other escaping operating fluids.

- ▶ Before opening the hood, allow the engine to cool down.
- ▶ In the event of a fire in the engine compartment, keep the hood closed and call the fire service.

**⚠ WARNING** - Risk of fire and injury from windshield washer concentrate

Windshield washer concentrate is highly flammable. It could ignite if it comes into contact with hot engine component parts or the exhaust system.

- ▶ Make sure that no windshield washer concentrate spills out next to the filler opening.

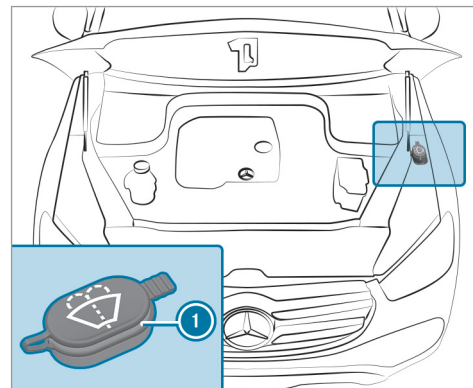

- ▶ Remove cap ① by the tab.
- ▶ Add washer fluid.
- Further information about the washer fluid (→ page 362)

### Keeping the air-water duct free

- ▶ Keep the area between the hood and the windshield free of deposits, e.g. ice, snow and leaves.

### Cleaning and care

#### Notes on washing the vehicle in a car wash

**⚠ WARNING** Risk of accident due to reduced braking effect after washing the vehicle

The braking effect is reduced after washing the vehicle.

- ▶ After the vehicle has been washed, brake carefully while paying attention to the traffic conditions until the braking effect has been fully restored.

**⚠ NOTE** Damage from automatic braking

If one of the following functions is switched on, the vehicle brakes automatically in certain situations:

- Active Brake Assist
- Active Distance Assist DISTRONIC
- HOLD function
- Active Parking Assist

To avoid damage to the vehicle, deactivate these systems in the following or similar situations:

- ▶ During towing
- ▶ In a car wash

**⚠ NOTE** Damage due to unsuitable car wash

- ▶ Before driving into a car wash make sure that the car wash is suitable for the vehicle dimensions.

- ▶ Ensure there is sufficient ground clearance between the underbody and the guide rails of the car wash.
- ▶ Ensure that the clearance width of the car wash, in particular the width of the guide rails, is sufficient.

To avoid damage to your vehicle when using a car wash, ensure the following beforehand:

- Active Distance Assist DISTRONIC and the HOLD function are deactivated.
- The surround view camera or the rear view camera is switched off.
- The side windows and sliding sunroof are completely closed.
- The outside mirrors are folded in.
- The blower for the ventilation/heating is switched off.
- The windshield wiper switch is in position .
- The SmartKey is at a minimum distance of 10 ft (3 m) away from the vehicle, otherwise the tailgate could open unintentionally.

- In car washes with a conveyor system: neutral **N** is engaged.
  - ① Drive straight and in to the center of the guide rails of the car wash to prevent damage to the tires and rims.
  - ① In car washes with a conveyor system: if you would like to leave the vehicle while it is being washed, make sure the SmartKey is located in the vehicle. The park position **P** is otherwise automatically engaged.
  - ① If, after the car wash, you remove the wax from the windshield and wiper rubbers, this will prevent smearing and reduce wiper noise.
- The rain sensor is deactivated to prevent the windshield washer system from starting up automatically.
  - The rear window wiper is deactivated.
  - The air conditioning system is set to air-recirculation mode.
  - Parking Assist PARKTRONIC is deactivated.
  - **Vehicles with surround view camera:** the front image is activated after approx. eight seconds.
  - **Vehicles with AIRMATIC:** the vehicle is raised to the maximum possible chassis level(→ page 203).

If rising takes longer than 25 seconds, the following message appears on the multifunction display:

[Preparation for Automatic Car Wash Incomplete See Media Display](#). After some time, the vehicle automatically continues rising.

- **Vehicles with E-ACTIVE BODY CONTROL:** the vehicle is raised to the maximum possible chassis level(→ page 209).

If rising takes longer than 25 seconds, the following message appears on the multifunction display:

[Preparation for Automatic Car Wash Incomplete See Media Display](#). After some time, the vehicle automatically continues rising.

If one of the settings cannot be selected, this is displayed by a **X** behind the respective setting.

Above a speed of 12 mph (20 km/h) car wash mode is automatically deactivated.

The following settings are reset when car wash mode is deactivated:

- The outside mirrors are folded out.
- The rain sensor is activated.
- The rear window wiper is activated.
- The air conditioning system is set to fresh air mode.
- Parking Assist PARKTRONIC is reset to the previously selected setting.

### Automatic car wash mode

In car wash mode, the vehicle is prepared for driving into the automatic car wash. Car wash mode can be activated at a speed of up to 12 mph (20 km/h) (→ page 297).

The following settings are made when car wash mode is activated:

- The outside mirrors are folded in.

- **Vehicles with surround view camera:** the front image is deactivated at speeds above 11 mph (18 km/h).
- **Vehicles with AIRMATIC:** the vehicle is lowered to the previously set chassis level.
- **Vehicles with E-ACTIVE BODY CONTROL:** the vehicle is lowered to the previously set chassis level.

### Activating/deactivating automatic car wash mode

#### Requirements:

- The vehicle is stationary.
- The engine is running.

Multimedia system:

→  → Settings → Quick Access

#### Activating automatic car wash mode

- ▶ Select [Automatic Car Wash Mode](#).
- ▶ Select [Start](#).

If one of the settings cannot be selected, this is displayed by a  behind the respective setting.

- ① For an overview of the settings made when activating automatic car wash mode (→ page 295).

#### Deactivating automatic car wash mode

- ▶ Select [Stop](#).  
The automatic car wash settings are reset.
- ① The automatic car wash mode is automatically deactivated as soon as a speed of 12 mph (20 km/h) is exceeded.

### Notes on using a power washer

 **WARNING** Risk of an accident when using power washers with round-spray nozzles

The water jet can cause externally invisible damage.

Components damaged in this way may unexpectedly fail.

- ▶ Do not use a power washer with round-spray nozzles.
- ▶ Have damaged tires or chassis parts replaced immediately.

To avoid damage to your vehicle, observe the following when using a power washer:

- Keep the SmartKey at least 10 ft (3 m) away from the vehicle. Otherwise the tailgate could open unintentionally.
- Maintain a distance of at least 11.8 in (30 cm) to the vehicle.
- **Vehicles with decorative foil:** parts of your vehicle are covered with a decorative foil. Maintain a distance of at least 27.6 in (70 cm) between the foil-covered parts of the vehicle and the nozzle of the power washer. Move the power washer nozzle around whilst cleaning. The water temperature of the power washer must not exceed 140 °F (60 °C).
- Observe the information on the correct distance in the equipment manufacturer's operating instructions.

- Do not point the nozzle of the power washer directly at sensitive parts such as tires, gaps, electrical components, batteries, light sources and ventilation slots.

### Washing the vehicle by hand

Observe the legal requirements, e.g. in a number of countries, washing by hand is only permitted in specially designated wash bays.

- ▶ Use a mild cleaning agent, e.g. car shampoo.
- ▶ Wash the vehicle with lukewarm water using a soft car sponge. When doing so, do not expose the vehicle to direct sunlight.
- ▶ Carefully hose the vehicle off with water and dry using a chamois. Take care not to point the water jet directly towards the air inlet grille below the hood.

### Notes on paintwork/matte finish paintwork care

Observe the notes on cleaning and care to avoid damaging the paintwork and interfering with the driver assistance systems.

### **Paint**

- Insect remains: soak with insect remover and rinse off the treated areas afterwards.
- Bird droppings: soak with water and rinse off afterwards.
- Tree resin, oils, fuels and greases: remove by rubbing gently with a cloth soaked in petroleum ether or lighter fluid.
- Coolant and brake fluid: remove with a damp cloth and clean water.
- Tar stains: use tar remover.
- Wax: use silicone remover.
- Do not attach stickers, films or similar materials. Only have film attached to the bumper at a qualified specialist workshop.
- Remove dirt immediately, where possible.

### **Matte finish**

- Only use care products approved for Mercedes-Benz.
- Do not attach stickers, films or similar materials. Only have film attached to the bumper at a qualified specialist workshop.

- Do not polish the vehicle and alloy wheels.
- Only use car washes that correspond to the latest engineering standards.
- Do not use car wash programs with a final hot wax treatment.
- Do not use paint cleaners, buffing or polishing products, gloss preservers, e.g. wax.

In the event of paintwork damage:

- Always have paintwork repairs carried out at a qualified specialist workshop.
- Make sure the radar sensors function (→ page 174).

### Notes on cleaning decorative foils

Observe the notes on matte finish care in the chapter "Notes on paintwork/matte finish paintwork care" (→ page 298). They also apply to matte decorative foils.

Observe the notes on cleaning decorative foils to avoid vehicle damage.

### Cleaning

- For cleaning, use plenty of water and a mild cleaning agent without additives or abrasive substances, e.g. a car shampoo approved for Mercedes-Benz.
- Remove dirt immediately, where possible, whilst avoiding rubbing too hard. There is otherwise a risk of damaging the decorative foil irreparably.
- If there is dirt on the finish or if the decorative foil is dull: use the Paint Cleaner recommended and approved for Mercedes-Benz.
- Insect remains: soak with insect remover and rinse off the treated areas afterwards.
- Bird droppings: soak with water and rinse off afterwards.
- To prevent water stains, dry a foil-wrapped vehicle with a soft, absorbent cloth after every car wash.

### Avoiding damage to the decorative foil

- The service life and color of decorative foils are impaired by:
  - Sunlight

- Temperature, e.g. hot air blower
- Weather conditions
- Stone chippings and dirt
- Chemical cleaning agents
- Oily products

- Do not use polish on matte decorative foil. Polishing will have the effect of shining the foil-wrapped surface.
- Do not treat matte or structured decorative foils with wax. Permanent stains may occur.

Scratches, corrosive deposits, areas affected by corrosion and damage caused by incorrect care cannot always be completely repaired. In such cases, visit a qualified specialist workshop.

You can obtain more information on care and cleaning products from the manufacturer.

In the case of foil-wrapped surfaces, optical differences may occur between the surfaces that were not protected by a decorative foil after removing a decorative foil.

- ① Have work or repairs to decorative foils carried out at a qualified specialist workshop, e.g. at an authorized Mercedes-Benz Center.

### Notes on care of vehicle parts

**⚠ WARNING** Risk of entrapment if the windshield wipers are switched on while the windshield is being cleaned

If the windshield wipers are set in motion while you are cleaning the windshield or wiper blades, you can be trapped by the wiper arm.

- ▶ Always switch off the windshield wipers and the ignition before cleaning the windshield or wiper blades.

**⚠ WARNING** Risk of burns from the tailpipe and tailpipe trims

The exhaust tailpipe and tailpipe trims can become very hot. If you come into contact with these parts of the vehicle, you could burn yourself.

- ▶ Always be particularly careful around the tailpipe and the tailpipe trims and supervise children especially closely in this area.
- ▶ Allow vehicle parts to cool down before touching them.

Observe the notes on cleaning and care of the following vehicle parts to avoid damage.

#### **Wheels/ribs**

- Use water and acid-free wheel cleaners.
- Do not use acidic wheel cleaners to remove brake dust. This could damage wheel bolts and brake components.
- To avoid corrosion of the brake discs and brake pads, drive the vehicle for a few minutes after cleaning before parking it. The brake discs and brake pads warm up and dry out.

#### **Windows**

- Clean windows inside and outside with a damp cloth and with a cleaning agent recommended for Mercedes-Benz.

- Do not use dry cloths or abrasive or solvent-based cleaning agents to clean the inside of windows.

#### **Wiper blades**

- Fold out the wiper blades and clean them using a damp cloth.
- Do not clean the wiper blades too often.

#### **Exterior lighting**

- Clean the lenses with a wet sponge and mild cleaning agent, e.g. car shampoo.
- Only use cleaning agents or cleaning cloths that are suitable for plastic lenses.

#### **Sensors**

- Clean the sensors in the front and rear bumper and in the radiator grill with a soft cloth and car shampoo.
- When using a power washer, maintain a minimum distance of 11.8 in (30 cm).

#### **Running boards**

- Use water and acid-free cleaning agents.
- Do not clean the aluminum trim insert of the running board with alkaline or acidic cleaning

agents such as wheel cleaners. Do not use acidic wheel cleaners to remove brake dust. The aluminum trim inserts could otherwise be damaged.

#### **Rear view camera and surround view camera**

- Open the camera cover with the multimedia system (→ page 223).
- Use clean water and a soft cloth to clean the camera lens.
- Do not use a power washer.

#### **Tailpipes**

- Clean with a cleaning agent recommended for Mercedes-Benz, especially in the winter and after washing the vehicle.
- Do not use acidic cleaning agents.

#### **Trailer hitch**

- Remove traces of rust on the ball, e.g. with a wire brush.
- Remove dirt with a lint-free cloth.
- After cleaning, oil or grease the ball head lightly.



- Observe the notes on care in the trailer hitch manufacturer's operating instructions.
- Do not clean the ball neck with a power washer or solvent.

### Notes on care of the interior

**⚠ WARNING** Risk of injury from plastic parts breaking off after the use of solvent-based care products

Care and cleaning products containing solvents can cause surfaces in the cockpit to become porous. When the airbags are deployed, plastic parts may break away.

▶ Do not use any care or cleaning products containing solvents to clean the cockpit.

**⚠ WARNING** Risk of injury or death from bleached seat belts

Bleaching or dyeing seat belts can severely weaken them.

This can, for example, cause seat belts to tear or fail in an accident.

▶ Never bleach or dye seat belts.

Observe the notes on cleaning and care to avoid vehicle damage.

#### Seat belts

- Clean with lukewarm and soapy water.
- Do not use chemical cleaning agents.
- Do not dry seat belts by heating them to over 176 °F (80 °C) or exposing them to direct sunlight.

#### Display

- Switch off the display and let it cool down.
- Clean the surface carefully with a microfiber cloth and a suitable display care product (TFT/LCD).
- Do not use any other agents.

#### Plastic trim

- Clean with a damp microfiber cloth.
- For heavy soiling: use a care product recommended for Mercedes-Benz.

- Do not attach stickers, films or similar materials.
- Do not allow cosmetics, insect repellent or sun cream to come in contact with the plastic trim.

#### Real wood/trim elements

- Clean with a microfiber cloth.
- Black piano-lacquer look: clean with a damp cloth and soapy water.
- For heavy soiling: use a care product recommended for Mercedes-Benz.
- Do not use solvent-based cleaning agents, polishes or waxes.

#### Headliner

- Clean with a brush or dry shampoo.

#### Carpet

- Use a carpet and textile cleaning agent recommended for Mercedes-Benz.

#### Genuine leather seat covers

- Clean with a damp cloth and then wipe with a dry cloth.

## 302 Maintenance and care

---

- Leather care: use a leather care agent that has been recommended for Mercedes-Benz.
- Do not allow the leather to become too damp.
- Do not use a microfiber cloth.

### **DINAMICA seat covers**

- Clean with a damp cloth.
- Do not use a microfiber cloth.

### **Imitation leather seat covers**

- Clean with a damp cloth and 1% soapy water.
- Do not use a microfiber cloth.

### **Cloth seat covers**

- Clean with a damp microfiber cloth and 1% soap solution and allow to dry.

## Flat tire

### Notes in the event of a flat tire

**⚠ WARNING** Risk of accident due to a flat tire

A flat tire severely affects the driving characteristics as well as the steering and braking of the vehicle.

#### Tires without run-flat characteristics:

- ▶ Do not drive with a flat tire.
- ▶ Change the flat tire immediately with an emergency spare wheel or spare wheel. Alternatively, consult a qualified specialist workshop.

#### Tires with run-flat characteristics:

- ▶ Observe the information and warning notes on MOExtended tires (run-flat tire).

In the event of a flat tire, the following options are available depending on your vehicle's equipment:

- **Vehicles with a TIREFIT kit:** you can repair the tire so that it is possible to continue the journey for a short period of time. To do this, use the TIREFIT kit (→ page 303).
  - **Vehicles with Mercedes me connect:** you can make a call for breakdown assistance via the overhead control panel in the case of a breakdown (→ page 271).
  - **All vehicles:** change the wheel (→ page 343).
- i** The emergency spare wheel is only available in certain countries.

### TIREFIT kit storage location

The TIREFIT kit is located under the cargo compartment floor.

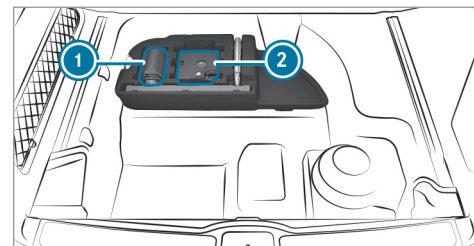

- 1** Tire sealant bottle
- 2** Tire inflation compressor

### Using the TIREFIT kit

#### Requirements:

- Tire sealant bottle and tire inflation compressor (→ page 303).
- TIREFIT sticker
- Gloves (depending on the vehicle equipment)

You can use TIREFIT tire sealant to seal perforation damage of up to 0.16 in (4 mm), particularly those in the tire contact surface. You can use

### 304 Breakdown assistance

TIREFIT in outside temperatures down to -4 °F (-20 °C).

#### **⚠ WARNING** Risk of accident when using tire sealant

The tire sealant may be unable to seal the tire properly, especially in the following cases:

- There are cuts or punctures in the tire larger than damage previously mentioned.
  - The wheel rim is damaged.
  - You have driven at very low tire pressure or on a flat tire.
- ▶ Do not continue driving.
- ▶ Consult a qualified specialist workshop.

#### **⚠ WARNING** Risk of injury and poisoning from tire sealant

The tire sealant is harmful and causes irritation. Do not allow it to come into contact with the skin, eyes or clothing, and do not

swallow it. Do not inhale tire sealant fumes. Keep the tire sealant away from children.

If you come into contact with the tire sealant, observe the following:

- ▶ Rinse off the tire sealant from your skin immediately using water.
- ▶ If tire sealant gets into your eyes, thoroughly rinse out the eyes using clean water.
- ▶ If tire sealant has been swallowed, immediately rinse out the mouth thoroughly and drink plenty of water. Do not induce vomiting and seek medical attention immediately.
- ▶ Change out of any clothes contaminated with tire sealant immediately.
- ▶ If allergic reactions occur, seek medical attention immediately.

**!** **NOTE** Overheating due to the tire inflation compressor running too long

- ▶ Do not run the tire inflation compressor for longer than ten minutes without interruption.

Comply with the manufacturer's safety notes on the sticker on the tire inflation compressor.

Have the tire sealant bottle replaced in a qualified specialist workshop every five years.

- ▶ Do not remove any foreign objects which have entered the tire.

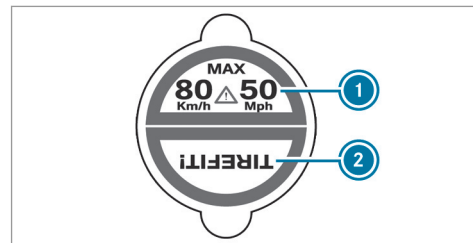

- ▶ Affix part ① of the TIREFIT sticker to the instrument cluster within the driver's field of vision.
- ▶ Affix part ② of the TIREFIT sticker near the valve on the wheel with the faulty tire.

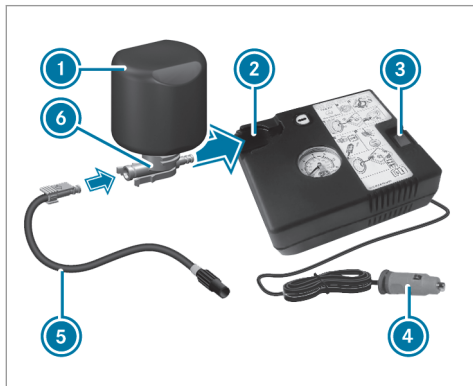

- ▶ Pull plug ④ with cable and hose ⑤ out of the tire inflation compressor housing.

- ▶ Push plug of hose ⑤ into flange ⑥ of tire sealant bottle ① until the plug engages.
- ▶ Place tire sealant bottle ① head downwards into recess ② of the tire inflation compressor.



- ▶ Remove the cap from valve ⑦ on the faulty tire.
- ▶ Screw filling hose ⑧ onto valve ⑦.
- ▶ Insert plug ④ into a 12 V socket in your vehicle.
- ▶ Switch on the ignition.

- ▶ Switch on the tire inflation compressor using On/Off switch ③.  
The tire is inflated. First, tire sealant is pumped into the tire. The pressure may briefly rise to approximately 500 kPa (5 bar/73 psi).

**Do not switch off the tire inflation compressor during this phase.**

- ▶ Let the tire inflation compressor run for a maximum of ten minutes.  
The tire should then have attained a tire pressure of at least 200 kPa (2.0 bar/29 psi).

If tire sealant leaks out, make sure you clean the affected area as quickly as possible. It is preferable to use clean water.

If you get tire sealant on your clothing, have it cleaned as soon as possible with perchloroethylene.

**If, after ten minutes, a tire pressure of 200 kPa (2.0 bar/29 psi) has not been attained:**

- ▶ Switch off the tire inflation compressor.

- ▶ Unscrew the filling hose from the valve of the faulty tire.

Please note that tire sealant may leak out when unscrewing the filling hose.

- ▶ Drive forwards or reverse very slowly for approximately 33 ft (10 m).
- ▶ Pump up the tire again.  
After a maximum of ten minutes the tire pressure must be at least 200 kPa (2.0 bar/29 psi).

**⚠ WARNING** Risk of accident due to the specified tire pressure not being attained

If the minimum tire pressure is not reached after the specified time, the tire is too badly damaged. The tire sealant cannot repair the tire in this instance.

The braking and driving characteristics may be greatly impaired.

- ▶ Do not continue driving.
- ▶ Consult a qualified specialist workshop.

**If, after ten minutes, a tire pressure of 200 kPa (2.0 bar/29 psi) has been attained:**

- ▶ Switch off the tire inflation compressor.
- ▶ Unscrew the filling hose from the valve of the faulty tire.

**⚠ WARNING** Risk of accident from driving with sealed tires

A tire temporarily sealed with tire sealant impairs the handling characteristics and is not suitable for higher speeds.

- ▶ Adapt your driving style accordingly and drive carefully.
- ▶ Do not exceed the maximum speed limit with a tire that has been repaired using tire sealant.

- ▶ Observe the maximum permissible speed for a tire sealed with tire sealant 50 mph (80 km/h).

**! NOTE** Staining caused by leaking tire sealant

After use, excess tire sealant may leak out from the filling hose.

- ▶ Therefore, place the filling hose in the plastic bag that contained the TIREFIT kit.

**🔥 ENVIRONMENTAL NOTE** Environmental pollution caused by environmentally irresponsible disposal

Tire sealant contains pollutants.

- ▶ Have the tire sealant bottle disposed of professionally, e.g. at an authorized Mercedes-Benz Center.

- ▶ Stow the tire sealant bottle and the tire inflation compressor.
- ▶ Pull away immediately.

- ▶ Stop driving after approximately ten minutes and check the tire pressure using the tire inflation compressor. The tire pressure must now be at least 130 kPa (1.3 bar/19 psi).

**⚠ WARNING** Risk of accident due to the specified tire pressure not being attained

If the specified tire pressure is not reached, the tire is too badly damaged. The tire sealant cannot repair the tire in this instance.

The braking and driving characteristics may be greatly impaired.

- ▶ Do not continue driving.
- ▶ Consult a qualified specialist workshop.

In cases such as the one mentioned above, contact an authorized Mercedes-Benz Center. Or call 1-800-FOR-MERCEDES (in the USA) or 1-800-387-0100 (in Canada).

- ▶ **To increase the tire pressure:** switch on the tire inflation compressor.

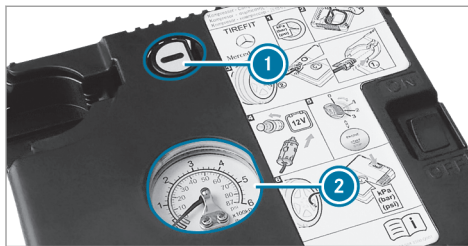

- ▶ **To reduce the tire pressure:** press pressure release button ① next to manometer ②.
- ▶ When the tire pressure is correct, unscrew the filling hose from the valve of the sealed tire.
- ▶ Screw the valve cap onto the valve of the sealed tire.
- ▶ Pull the tire sealant bottle out of the tire inflation compressor. The filling hose stays on the tire sealant bottle.
- ▶ Drive to the nearest qualified specialist workshop and have the tire, tire sealant bottle and filling hose replaced there.

## Battery (vehicle)

### Notes on the 12 V battery

- ⚠ WARNING** Risk of an accident due to work carried out incorrectly on the battery

Work carried out incorrectly on the battery can, for example, lead to a short circuit. This can restrict functions relevant for safety systems and impair the operating safety of your vehicle.

You could lose control of the vehicle in the following situations in particular:

- When braking
- In the event of abrupt steering maneuvers and/or when the vehicle's speed is not adapted to the road conditions
- ▶ In the event of a short circuit or a similar incident, contact a qualified specialist workshop immediately.
- ▶ Do not drive on.

► Always have work on the battery carried out at a qualified specialist workshop.

- Further information on ABS (→ page 175)
- Further information on ESP® (→ page 176)

For safety reasons, Mercedes-Benz recommends that you only use batteries which have been tested and approved for your vehicle by Mercedes-Benz.

#### All vehicles except vehicles with a lithium-ion battery

**⚠ WARNING** Risk of explosion due to electrostatic charge

Electrostatic charge can ignite the highly explosive gas mixture in the battery.

- To discharge any electrostatic charge that may have built up, touch the metal vehicle body before handling the battery.

The highly flammable gas mixture is created while the battery is charging and during starting assistance.

**⚠ WARNING** Danger of chemical burns from the battery acid

Battery acid is caustic.

- Avoid contact with the skin, eyes or clothing.
- Do not lean over the battery.
- Do not inhale battery gases.
- Keep children away from the battery.
- Immediately rinse battery acid off thoroughly with plenty of clean water and seek medical attention immediately.

#### All vehicles

**🔥 ENVIRONMENTAL NOTE** Environmental damage caused by improper disposal of batteries



Batteries contain pollutants. It is illegal to dispose of them with the household rubbish.



► Dispose of batteries in an environmentally responsible manner. Take discharged batteries to a qualified specialist workshop or to a collection point for used batteries.

If you have to disconnect the 12 V battery, contact a qualified specialist workshop.

Comply with safety notes and take protective measures when handling batteries.





Risk of explosion.



Fire, open flames and smoking are prohibited when handling the battery. Avoid creating sparks.



Electrolyte or battery acid is corrosive. Avoid contact with the skin, eyes or clothing. Wear suitable protective clothing, in particular gloves, an apron and a face mask. Immediately rinse electrolyte or acid splashes off with clean water. Consult a doctor if necessary.



Wear safety glasses.



Keep children away.



Observe this Operator's Manual.

Observe the following if you do not intend to use the vehicle over an extended period of time:

- Activate standby mode.
- Alternatively: connect the battery to a battery charger approved by Mercedes-Benz or consult a qualified specialist workshop to disconnect the battery.

### Notes on starting assistance and charging the 12 V battery

#### Vehicles with a lithium-ion battery

When charging the battery and during starting assistance, always use the jump-start connection point in the engine compartment.

**!** **NOTE** Damaging the battery through overvoltage

When charging using a battery charger without a maximum charging voltage, the battery or the vehicle electronics may be damaged.

- ▶ Only use battery chargers with a maximum charging voltage of 14.8 V.

#### All other vehicles

When charging the battery and during starting assistance, always use the jump-start connection point in the engine compartment.

**!** **NOTE** Damaging the battery through overvoltage

When charging using a battery charger without a maximum charging voltage, the battery or the vehicle electronics may be damaged.

- ▶ Only use battery chargers with a maximum charging voltage of 14.8 V.

**⚠ WARNING** Risk of explosion from hydrogen gas igniting

There is a danger of hydrogen gas igniting when charging the battery if there is a short circuit or sparks start to form.

- ▶ Make sure that the positive terminal of the connected battery does not come into contact with vehicle parts.
- ▶ Never place metal objects or tools on a battery.
- ▶ The described order of the battery clamps must be observed when connecting and disconnecting the battery.
- ▶ When giving starting assistance, always make sure that you only connect battery terminals with identical polarity.
- ▶ During starting assistance, you must observe the described order for connecting and disconnecting the jumper cable.
- ▶ Do not connect or disconnect the battery clamps while the engine is running.

**⚠ WARNING** Risk of explosion during charging process and starting assistance

During the charging process and starting assistance, the battery may release an explosive gas mixture.

- ▶ Avoid fire, open flames, creating sparks and smoking.
- ▶ Make sure there is sufficient ventilation.
- ▶ Do not lean over a battery.

**⚠ WARNING** Risk of explosion from a frozen battery

A discharged battery may freeze at temperatures slightly above or below freezing point.

During starting assistance or battery charging, battery gas can be released.

- ▶ Always allow a battery to thaw before charging it or performing starting assistance.

If the indicator/warning lamps in the instrument cluster do not light up at low temperatures, it is very likely that the discharged battery has frozen. In this case you may neither jump-start the vehicle nor charge the battery.

The service life of a battery that has been thawed may be dramatically shortened. The starting characteristics may be impaired, especially at low temperatures.

It is recommended that you have a thawed battery checked at a qualified specialist workshop.

**All vehicles**

**!** **NOTE** Damage caused by numerous or extended attempts to start the engine

Numerous or extended attempts to start the engine may damage the catalytic converter due to non-combusted fuel.

- ▶ Avoid numerous and extended attempts to start the engine.

Observe the following points during starting assistance and when charging the battery:

- Only use undamaged jumper cables/charging cables with a sufficient cross-section and insulated terminal clamps.
- Non-insulated parts of the terminal clamps must not come into contact with other metal parts while the jumper cables/charging cable is connected to the battery/jump-start connection point.
- The jumper cable/charging cable must not come into contact with any parts which may move when the engine is running.
- Always make sure that neither you nor the battery is electrostatically charged.
- Keep away from fire and open flames.
- Do not lean over the battery.

Observe the additional following points when charging the battery:

- Only use battery chargers tested and approved for Mercedes-Benz.
- Read the battery charger's operating instructions before charging the battery.

Observe the additional following points during starting assistance:

- Starting assistance may only be provided using vehicles, batteries or other jump start devices with a nominal voltage of 12 V.
- The vehicles must not touch.
- **Vehicles with a gasoline engine:** Jump-start the vehicle only when the engine and exhaust system are cold.

### Starting assistance and charging the 12 V battery

#### Requirements:

- The vehicle is secured with the electric parking brake.
- **Vehicles with automatic transmission:** The transmission is in position **[P]**.
- The ignition and all electrical consumers are switched off.
- The hood is open.

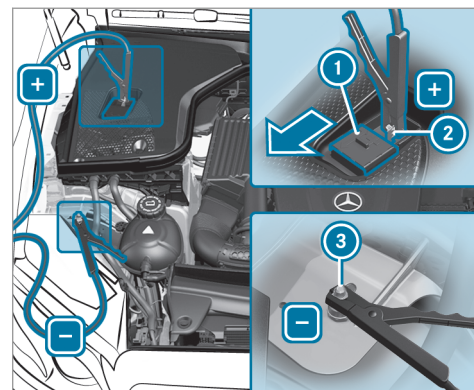

Example: engine compartment

- ▶ Slide cover ① of positive clamp ② on the jump-starting connection point in the direction of the arrow.
- ▶ Connect positive clamp ② on your vehicle to the positive pole of the donor battery using the jumper cable/charging cable. Always

begin with positive clamp ② on your own vehicle first.

- ▶ **During starting assistance:** start the engine of the donor vehicle and run at idle speed.
- ▶ Connect the negative pole of the donor battery and ground point ③ of your own vehicle by using the jumper cable/charging cable. Begin with the donor battery first.
- ▶ **During starting assistance:** start the engine of your own vehicle.
- ▶ **During the charging process:** start the charging process.
- ▶ **During starting assistance:** let the engines run for several minutes.
- ▶ **During starting assistance:** before disconnecting the jumper cable, switch on an electrical consumer in your own vehicle, e.g. the rear window heater or lighting.

When the starting assistance/charging process is complete, perform the following steps:

- ▶ First, remove the jumper cable/charging cable from ground point ③ and the negative pole of the donor battery, then from positive clamp ② and the positive pole of the donor battery. Begin each time with the contacts on your own vehicle first.
- ▶ After removing the jumper cable/charging cable, close cover ① of positive clamp ②.

Further information can be obtained at a qualified specialist workshop.

### Replacing the 12 V battery

- ▶ Observe the notes on the 12 V battery (→ page 307).

Mercedes-Benz recommends that you have the 12 V battery replaced at a qualified specialist workshop, e.g. at an authorized Mercedes-Benz Center.

Observe the following notes if you want to replace the battery yourself:

- Always replace a faulty battery with a battery which meets the specific vehicle requirements.  
The vehicle is equipped with an AGM technology battery (Absorbent Glass Mat) or a lithium-ion battery. Full vehicle functionality is only guaranteed with an AGM battery or lithium-ion battery. For safety reasons, Mercedes-Benz recommends that you only use batteries which have been tested and approved for your vehicle by Mercedes-Benz.
- Carry over detachable parts, such as vent hoses, elbow fitting or terminal covers from the battery being replaced.
- Make sure that the vent hose is always connected to the original opening on the side of the battery.  
Install any existing or supplied cell caps. Otherwise, gases or battery acid could escape.
- Make sure that detachable parts are reconnected in the same way.

## Tow starting or towing away

### Permitted towing methods

#### ! NOTE Damage from automatic braking

If one of the following functions is switched on, the vehicle brakes automatically in certain situations:

- Active Brake Assist
- Active Distance Assist DISTRONIC

- HOLD function
- Active Parking Assist

To avoid damage to the vehicle, deactivate these systems in the following or similar situations:

- ▶ During towing
- ▶ In a car wash



Mercedes-Benz recommends transporting your vehicle in the case of a breakdown, rather than towing it away.

For towing, use a tow rope or tow bar with both axles on the ground. Do not use tow bar systems.

#### ! NOTE Damage to the vehicle due to towing away incorrectly

- ▶ Observe the instructions and notes on towing away.

### Permitted towing methods

Vehicle equipment/towing method	 Both axles on the ground	 Front axle raised	 Rear axle raised
4MATIC vehicles	Yes, maximum 31 miles (50 km) at 31 mph (50 km/h)	No	No

### Towing away the vehicle with both axles on the ground

- ▶ Observe the notes on the permitted towing methods (→ page 313).
- ▶ Make sure that the battery is connected and charged.

A discharged battery has the following effects:

- The engine cannot be started
  - The electric parking brake cannot be released or applied
  - The automatic transmission cannot be shifted to position **N** or **P**
- i** If the automatic transmission cannot be shifted to position **N**, or the multifunction display in the instrument cluster does not show anything, the vehicle must be transported away (→ page 315). A towing vehicle with lifting equipment is required for vehicle transportation.

**!** **NOTE** Damage due to towing away at excessively high speeds or over long distances

The drivetrain could be damaged when towing at excessively high speeds or over long distances.

- ▶ A towing speed of 30 mph (50 km/h) must not be exceeded.
- ▶ A towing distance of 30 miles (50 km) must not be exceeded.

**!** **WARNING** Risk of accident when towing a vehicle which is too heavy

If the vehicle being tow-started or towed away is heavier than the permissible gross mass of your vehicle, the following situations can occur:

- The towing eye may become detached.
  - The vehicle/trailer combination may swerve or even overturn.
- ▶ If another vehicle is tow-started or towed away, its weight must not exceed

the permissible gross mass of your own vehicle.

- ▶ Information on the permissible gross mass of the vehicle can be found on the vehicle identification plate (→ page 355).
- ▶ Do not open the driver's door or front passenger door as the automatic transmission may otherwise shift to position **P** automatically.
- ▶ Install the towing eye (→ page 317).
- ▶ Fasten the tow bar.

**!** **NOTE** Damage due to incorrect connection of the tow bar

- ▶ Only connect the tow rope or tow bar to the towing eyes.

- i** You can also attach the tow bar to the trailer hitch.
- ▶ Deactivate the automatic locking mechanism (→ page 70).
- ▶ Do not activate the HOLD function.

- ▶ Deactivate the tow-away alarm (→ page 86).
- ▶ Deactivate Active Brake Assist (→ page 184).
- ▶ Shift the automatic transmission to position **N** (→ page 161).
- ▶ Release the electric parking brake.

**⚠ WARNING** Risk of accident due to limited safety-related functions during the towing process

Safety-related functions are limited or no longer available in the following situations:

- the ignition is switched off.
- the brake system or power steering system is malfunctioning.
- the energy supply or the on-board electrical system is malfunctioning.

When your vehicle is then towed away, significantly more effort may be required to steer and brake than is normally required.

- ▶ Use a tow bar.

- ▶ Make sure that the steering wheel can move freely, before towing the vehicle away.

**⚠ NOTE** Damage due to excessive tractive power

If you pull away sharply, the tractive power may be too high and the vehicles could be damaged.

- ▶ Pull away slowly and smoothly.

### Loading the vehicle for transport

- ▶ Observe the notes on towing away (→ page 314).
- ▶ Connect the tow bar to the towing eye in order to load the vehicle.
- ⓘ You can also attach the tow bar to the trailer hitch.
- ▶ Shift the automatic transmission to position **N**.

- ⓘ The automatic transmission may be locked in position **P** in the event of damage to the electrics. To shift to **N**, provide the on-board electrical system with power (→ page 311).

- ▶ Load the vehicle onto the transporter.
- ▶ Shift the automatic transmission to position **P**.
- ▶ Use the electric parking brake to secure the vehicle against rolling away.
- ▶ Only secure the vehicle by the wheels.

### Vehicles with ADS PLUS (Adaptive Damping System PLUS)

**⚠ WARNING** Risk of an accident when transporting vehicles with Adaptive Damping System PLUS

The reduced damping forces on the vehicle being transported can cause the vehicle/trailer combination to start to swing.

As a result, when transporting vehicles with the Adaptive Damping System PLUS, the

vehicle/trailer combination may start to skid. Consequently, you could lose control of your vehicle.

- ▶ When transporting, ensure that:
  - The vehicle has been loaded onto the transporter correctly
  - The vehicle is secured at all four wheels with suitable tensioning straps
  - The maximum permissible speed of 35 mph (60 km/h) is not exceeded when transporting

**!** **NOTE** Damage to the vehicle from securing it incorrectly

- ▶ After loading, the vehicle must be secured on all four wheels. Otherwise, the vehicle could be damaged.
- ▶ A minimum distance of 8 in (20 cm) upwards and 4 in (10 cm) downwards must be kept to the transport platform.

- ▶ Secure the vehicle on all four wheels after loading.

**4MATIC vehicles/vehicles with automatic transmission**

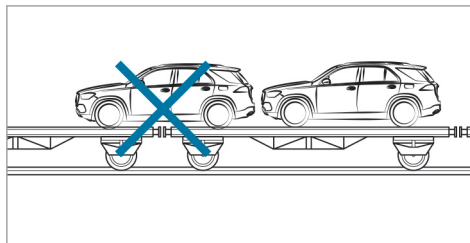

- ▶ Make sure that the front and rear axles come to rest on the same transportation vehicle.

**!** **NOTE** Damage to the drivetrain due to incorrect positioning

- ▶ Do not position the vehicle above the connection point of the transport vehicle.

**Towing eye storage location**

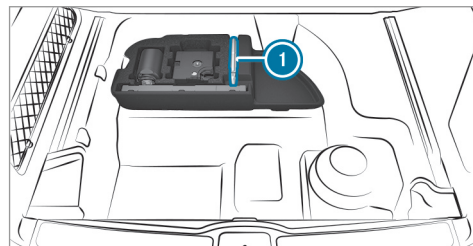

Towing eye ① is located under the cargo compartment floor with the tire-change tool kit.



## Installing the towing eye

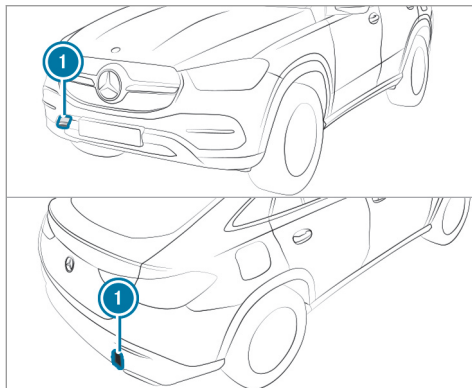

- ▶ Press the mark on cover ❶ inwards and remove.
- ▶ Screw in the towing eye clockwise as far as it will go and tighten.

**Vehicles with a trailer hitch:** Vehicles with a trailer hitch do not have a rear bracket for the

towing eye. Fasten the tow bar to the trailer hitch.

- ❶ Make sure that cover ❶ engages in the bumper when you remove the towing eye.

**NOTE** Damage to the vehicle due to incorrect use of the towing eye

When a towing eye is used to recover a vehicle, the vehicle may be damaged in the process.

- ▶ Only use the towing eye to tow away or tow start the vehicle.

## Tow starting the vehicle (emergency engine start)

### Vehicles with automatic transmission

**NOTE** Damage to the automatic transmission due to tow starting

The automatic transmission may be damaged in the process of tow starting vehicles with automatic transmission.

- ▶ Vehicles with automatic transmission must not be tow started.

- ▶ Vehicles with automatic transmission must not be tow-started.

## Electrical fuses

### Notes on electrical fuses

**WARNING** Risk of accident and injury due to overloaded lines

If you manipulate or bridge a faulty fuse or if you replace it with a fuse with a higher amperage, the electric line could be overloaded.

This could result in a fire.

- ▶ Always replace faulty fuses with specified new fuses containing the correct amperage.

**!** **NOTE** Damage due to incorrect fuses

Electrical components or systems may be damaged by incorrect fuses, or their functionality may be significantly impaired.

- ▶ Only use fuses that have been approved by Mercedes-Benz and which have the correct fuse rating.

Blown fuses must be replaced with fuses of the same rating, which you can recognize by the color and fuse rating. The fuse ratings and further information to be observed can be found in the fuse assignment diagram.

**Fuse assignment diagram:** on the fuse box in the cargo compartment (→ page 319).

**!** **NOTE** Damage or malfunctions caused by moisture

Moisture may cause damage to the electrical system or cause it to malfunction.

- ▶ When the fuse box is open, make sure that no moisture can enter the fuse box.
- ▶ When closing the fuse box, make sure that the seal of the lid is positioned correctly on the fuse box.

If the newly inserted fuse also blows, have the cause traced and rectified at a qualified specialist workshop.

Ensure the following before replacing a fuse:

- The vehicle is secured against rolling away.
- All electrical consumers are switched off.
- The ignition is switched off.

The electrical fuses are located in various fuse boxes:

- Fuse box in the engine compartment on the left-hand side of the vehicle, when viewed in the direction of travel (→ page 318)
- Fuse box on the driver's side of the cockpit (→ page 319)

- Fuse box in the front passenger footwell (→ page 319)
- Fuse box in the cargo compartment on the right-hand side of the vehicle, when viewed in the direction of travel (→ page 319)

### Opening and closing the fuse box in the engine compartment

**Requirement:**

- You need a dry cloth and a screwdriver.

Observe the notes on electrical fuses (→ page 317).

**Opening**

**⚠ WARNING** Risk of injury from using the windshield wipers while the engine hood is open

When the engine hood is open and the windshield wipers are set in motion, you can be trapped by the wiper linkage.

- ▶ Always switch off the windshield wipers and ignition before opening the engine hood.

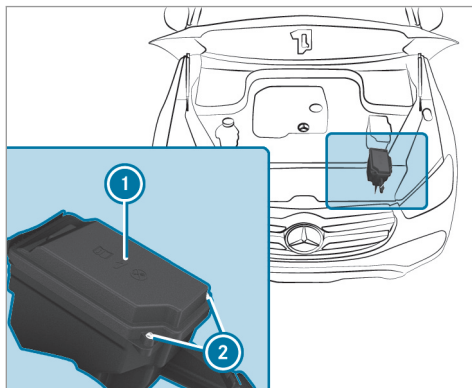

- ▶ Remove any existing moisture from the fuse box using a dry cloth.
- ▶ Loosen screws ② and remove fuse box lid ① from the top.

### Closing

- ▶ Check whether the seal is positioned correctly in the lid.
- ▶ Insert the lid into the bracket at the rear of the fuse box.
- ▶ Fold down the lid of the fuse box and tighten screws ②.
- ▶ Close the hood.

### Opening and closing the fuse box in the cockpit

The fuse box is on the side of the dashboard under a cover.

- ▶ Contact an authorized Mercedes-Benz Center for further information.

### Opening and closing the fuse box in the front passenger footwell

- ▶ Contact an authorized Mercedes-Benz Center for further information.

### Opening and closing the fuse box in the cargo compartment

Observe the notes on electrical fuses (→ page 317).

- ▶ Open the side cover.

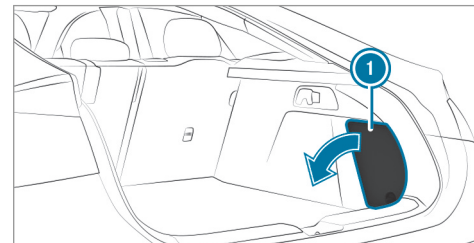

- ▶ Remove cover ①.

The fuse allocation chart is on the side of the fuse box.

### Notes on noise or unusual handling characteristics

Make sure there are no vibrations, noises or unusual handling characteristics when the vehicle is in motion. This may indicate that the wheels or tires are damaged. Hidden tire damage could also be causing the unusual handling characteristics.

If you suspect that a tire is malfunctioning, reduce your speed immediately and have the tires and wheels checked at a qualified specialist workshop.

### Notes on regularly inspecting wheels and tires

**⚠ WARNING** Risk of injury through damaged tires

Damaged tires can cause tire pressure loss.

- ▶ Check the tires regularly for signs of damage and replace any damaged tires immediately.

**⚠ WARNING** Risk of hydroplaning due to insufficient tire tread

Insufficient tire tread will result in reduced tire grip.

In heavy rain or slush the risk of hydroplaning is increased, in particular where speed is not adapted to suit the conditions.

- ▶ Thus, you should regularly check the tread depth and the condition of the tread across the entire width of all tires.

Minimum tread depth for:

- Summer tires:  $\frac{1}{8}$  in (3 mm)
- M+S tires:  $\frac{1}{16}$  in (4 mm)

- ▶ For safety reasons, replace the tires before the legally-prescribed limit for the minimum tread depth is reached.

Carry out the following checks on all wheels regularly, at least once a month or as required, for example, prior to a long journey or driving off-road:

- Check the tire pressure (→ page 321).

- Visually inspect wheels and tires for damage.
- Check the valve caps.
- Visual check of the tire tread depth and the tire contact surface across the entire width.  
The minimum tread depth for summer tires is  $\frac{1}{8}$  in (3 mm) and for winter tires  $\frac{1}{16}$  in (4 mm).

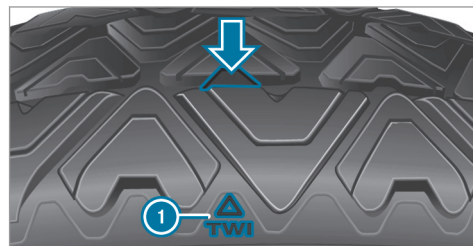

Six marks ① show where the bar indicators (arrow) are integrated into the tire tread. They are visible once a tread depth of approximately  $\frac{1}{16}$  in (1.6 mm) has been reached.

### Notes on snow chains

**!** **NOTE** Damage to components of the vehicle body or chassis due to fitted snow chains

If you fit snow chains to the front wheels of 4MATIC vehicles, you may damage components of the vehicle body or chassis.

▶ Only fit snow chains to the rear wheels of 4MATIC vehicles.

- Snow chains are only permissible for certain wheel/tire combinations. You can obtain information about this from an authorized Mercedes-Benz Center.
- For safety reasons, only use snow chains that have been specifically approved for your vehicle by Mercedes-Benz, or snow chains with the same quality standard.
- If snow chains are installed, the maximum permissible speed is 30 mph (50 km/h).
- **Vehicles with Active Parking Assist:** Do not use Active Parking Assist when snow chains are installed.

- **Vehicles with AIRMATIC or E-ACTIVE BODY CONTROL:** If snow chains are installed, only drive at raised vehicle level .

ⓘ You can deactivate ESP® to pull away (→ page 178). This allows the wheels to spin, achieving an increased driving force.

### Tire pressure

#### Notes on tire pressure

**⚠ WARNING** Risk of accident due to insufficient or excessive tire pressure

Underinflated or overinflated tires pose the following risks:

- The tires may burst, especially as the load and vehicle speed increase.
- The tires may wear excessively and/or unevenly, which may greatly impair tire traction.
- The driving characteristics, as well as steering and braking, may be greatly impaired.

▶ Comply with the recommended tire pressure and check the tire pressure of all tires including the spare wheel regularly:

- at least once a month
- when the load changes
- before embarking on a longer journey
- if operating conditions change, e.g. off-road driving

▶ Adjust the tire pressure as necessary.

Tire pressure which is too high or too low can:

- Shorten the service life of the tires.
- Cause increased tire damage.
- Adversely affect driving characteristics and thus driving safety, e.g. due to hydroplaning.

**⚠ WARNING** Risk of an accident due to insufficient tire pressure

Tires with pressure that is too low can overheat and burst as a result.

## 322 Wheels and tires

In addition, they also suffer from excessive and/or irregular wear, which can significantly impair the braking properties and the handling characteristics.

- ▶ Avoid excessively low tire pressures in all the tires, including the spare wheel.

Tire pressure which is too low can cause:

- Tire malfunctions as a result of overheating
- Impaired handling characteristics
- Irregular wear
- Increased fuel consumption

**⚠ WARNING** Risk of accident from excessive tire pressure

Tires with excessively high pressure can burst because they are damaged more easily by highway fill, pot holes etc.

In addition, they also suffer from irregular wear, which can significantly impair the braking properties and the handling characteristics.

- ▶ Avoid excessively high tire pressures in all the tires, including the spare wheel.

Tire pressure which is too high can cause:

- Increased braking distance
- Impaired handling characteristics
- Irregular wear
- Impaired driving comfort
- Susceptibility to damage

**⚠ WARNING** Risk of accident caused by repeated drop in tire pressure

If the tire pressure drops repeatedly, the wheel, valve or tire may be damaged.

Insufficient tire pressure can cause the tires to burst.

- ▶ Inspect the tire for signs of foreign objects.
- ▶ Check whether the wheel or valve has a leak.
- ▶ If you are unable to rectify the damage, contact a qualified specialist workshop.

You can find information on tire pressure for the vehicle's factory-installed tires on the following labels:

- Tire and Loading Information placard on the B-pillar of your vehicle (→ page 326).
- Tire pressure table on the inside of the fuel filler flap (→ page 323).

Observe the maximum tire pressure (→ page 333).

Use a suitable pressure gauge to check the tire pressure. The outer appearance of a tire does not permit any reliable conclusion about the tire pressure.

Only correct tire pressure when the tires are cold. Conditions for cold tires:

- The vehicle has been parked with the tires out of direct sunlight for at least three hours.
- The vehicle has traveled less than 1 mile (1.6 km).

The vehicle's tires heat up when driving. As the temperature of the tires increases, so too does the tire pressure.

**Vehicles with a tire pressure monitoring system:** You can also check the tire pressure using the on-board computer.

The tire pressure recommended for increased load/speed in the tire pressure table can affect the ride comfort.

**⚠ WARNING** Risk of accident due to unsuitable accessories on tire valve

If you mount unsuitable accessories onto tire valves, the tire valves may be overloaded and malfunction, which can cause a loss of tire pressure. Aftermarket tire pressure monitoring systems will cause the tire valve to remain open, depending on the design. This can also result in a loss of tire pressure.

- ▶ Only screw standard valve caps or valve caps specifically approved by Mercedes-Benz for your vehicle onto the tire valve.

**Notes on towing a trailer**

Always inflate the rear axle tires to the recommended tire pressure on the tire pressure table for increased load.

**Tire pressure table**

The tire pressure table is on the inside of the fuel filler flap.

- ⓘ The data shown in the images is example data.

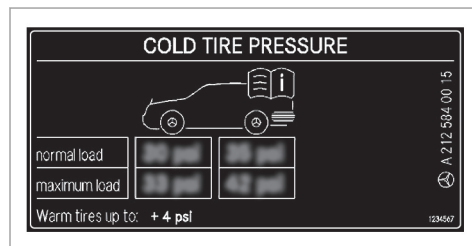

If one or more tire sizes precede a tire pressure, the following tire pressure information is only valid for those tire sizes and their respective load condition.

The load conditions "partially laden" and "fully laden" are defined in the table for different numbers of passengers and amounts of luggage. The actual number of seats may differ from this.

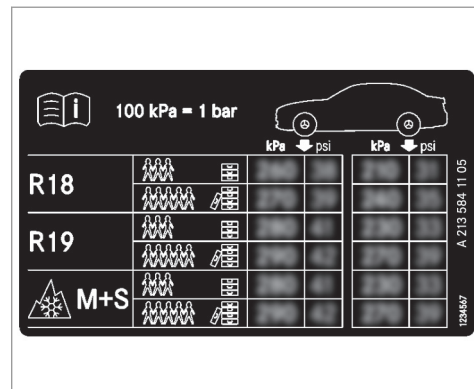

Some tire pressure tables only show the rim diameter instead of the complete tire size, e.g. **R18**. The rim diameter is part of the tire size and can be found on the tire side wall (→ page 334).

- Tire and Loading Information placard (→ page 326)
- Maximum tire pressure (→ page 333)

### Checking tire pressures manually

- ▶ Read the tire pressure for the current operating conditions from the Tire and Loading Information placard or the tire pressure table. Observe the notes on tire pressure.
- ▶ Remove the valve cap of the tire to be checked.
- ▶ Press the tire pressure gauge securely onto the valve.
- ▶ Read the tire pressure.
- ▶ If the tire pressure is lower than the recommended value, increase the tire pressure to the recommended value.
- ▶ If the tire pressure is higher than the recommended value, release air. To do so, press down the metal pin in the valve, e.g. using the tip of a pen for example. Then check the tire pressure again using the tire pressure gauge.
- ▶ Screw the valve cap onto the valve.

Further related subjects:

- Notes on tire pressure (→ page 321)

- Tire pressure table (→ page 323)
- Tire and Loading Information placard (→ page 326)

### Tire pressure monitoring system

#### Function of the tire pressure monitoring system

**⚠ DANGER** Risk of accident due to incorrect tire pressure

Each tire, including the spare (if provided), should be checked monthly when cold and inflated to the inflation pressure recommended by the vehicle manufacturer on the vehicle placard or tire inflation pressure label. (If your vehicle has tires of a different size than the size indicated on the vehicle placard or tire inflation pressure label, you should determine the proper tire inflation pressure for those tires.)

As an added safety feature, your vehicle has been equipped with a tire pressure monitoring system (TPMS) that illuminates a low tire

pressure telltale when one or more of your tires is significantly under-inflated. Accordingly, when the low tire pressure telltale illuminates, you should stop and check your tires as soon as possible, and inflate them to the proper pressure. Driving on a significantly under-inflated tire causes the tire to overheat and can lead to tire failure. Under-inflation also reduces fuel efficiency and tire tread life, and may affect the vehicle's handling and stopping ability. Please note that the TPMS is not a substitute for proper tire maintenance, and it is the driver's responsibility to maintain correct tire pressure, even if under-inflation has not reached the level to trigger illumination of the TPMS low tire pressure telltale.

Your vehicle has also been equipped with a TPMS malfunction indicator to indicate that the system is not operating properly. The TPMS malfunction indicator is combined with the low tire pressure telltale. When the system detects a malfunction, the indicator lamp will flash for approximately one minute



and then remain continuously illuminated. This sequence will continue upon subsequent vehicle start-ups as long as the malfunction exists.

When the malfunction indicator is illuminated, the system may not be able to detect or signal low tire pressure as intended. TPMS malfunctions may occur for a variety of reasons, including the installation of replacement or alternate tires or wheels on the vehicle that prevent the TPMS from functioning properly.

Always check the TPMS malfunction telltale after replacing one or more tires or wheels on your vehicle to ensure that the replacement or alternate tires and wheels allow the TPMS to continue to function properly.

The system checks the tire pressure and the tire temperature of the tires installed to the vehicle by means of a tire pressure sensor.

The tire pressure and the tire temperature appear in the multifunction display (→ page 325).

If there is a substantial pressure loss or if the tire temperature is excessive, you will be warned in the following ways:

- via display messages (→ page 412)
- via the  warning lamp in the instrument cluster

The tire pressure monitoring system is only an aid. It is the driver's responsibility to set the tire pressure to the recommended cold tire pressure suitable for the operating situation.

In most cases, the tire pressure monitoring system will automatically update the new reference values after you have changed the tire pressure. You can, however, also update the reference values by restarting the tire pressure monitoring system manually (→ page 326).

### System limits

The system may be impaired or may not function in the following situations:

- the tire pressure has been set incorrectly
- there is a sudden pressure loss caused, for example, by a foreign object penetrating the tire

- there is a malfunction caused by another radio signal source

### Checking the tire pressure with the tire pressure monitoring system

#### Requirements:

- The ignition is switched on.

On-board computer:

 [Service](#)  [Tires](#)

One of the following displays appears:

- Current tire pressure and tire temperature of the individual wheels:

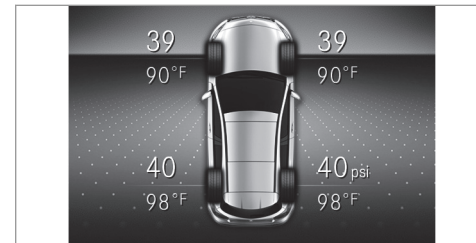

- **Tire pressure will be displayed after driving a few minutes**
- **Tire Pressure Monitor Active:** the teach-in process of the system is not yet complete. The tire pressures are already being monitored.

▶ Compare the tire pressure with the recommended tire pressure for the current operating condition (→ page 323). Observe the notes on tire temperature (→ page 321).

ⓘ The values displayed in the multifunction display may deviate from those of the tire pressure gauge as they refer to sea level. At high altitudes, the tire pressure value indicated by a pressure gauge are higher than those shown by the on-board computer. In this case, do not reduce the tire pressure.

### Restarting the tire pressure monitoring system

#### Requirements:

- The recommended tire pressure is correctly set for the respective operating status on all of the wheels (→ page 321).

Restart the tire pressure monitoring system in the following situations:

- The tire pressure has changed.
- The wheels or tires have been changed or newly installed.

On-board computer:

↳ Service ▶▶ Tires

▶ Swipe downwards on Touch Control on the left-hand side of the steering wheel. The **Use Current Pressures as New Reference Values** message is shown in the multifunction display.

▶ To restart, press Touch Control on the left-hand side of the steering wheel. The **Tire Press. Monitor Restarted** message is shown in the multifunction display.

Current warning messages are deleted and the yellow  warning lamp goes out.

After you have been driving for a few minutes, the system checks whether the current tire pressures are within the specified range. The current tire pressures are then accepted as reference values and monitored.

Be sure to also pay attention to the following related topic:

- Notes on tire pressure (→ page 321)

### Loading the vehicle

#### Notes on Tire and Loading Information placard

 **WARNING** Risk of accident from overloaded tires

Overloaded tires may overheat and burst as a consequence. Overloaded tires can also impair the steering and handling characteristics and lead to brake failure.

- ▶ Observe the load-bearing capacity of the tires.
- ▶ The load-bearing capacity must be at least half the gross axle weight rating of the vehicle.
- ▶ Never overload the tires by exceeding the maximum load.

The Tire and Loading Information placard is on the B-pillar on the driver's side of the vehicle.

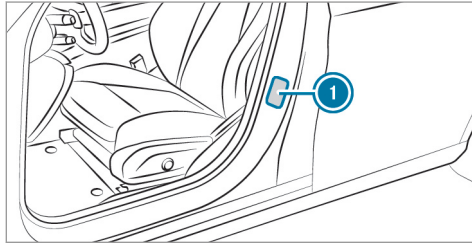

1 Tire and Loading Information placard

TIRE AND LOADING INFORMATION		RENSEIGNEMENTS POUR LES PNEUS ET LE CHARGEMENT	
SEATING CAPACITY NOMBRE DE PLACES	TOTAL 7	FRONT AVANT 2	MIDDLE MILIEU 3
		REAR ARRIERE 2	
The combined weight of occupants and cargo should never exceed XXX kg or XXX lbs. Le poids total des occupants et du chargement ne doit jamais dépasser XXX kg ou XXX lbs.*			
TIRE PNEU	SIZE DIMENSIONS	COLD TIRE PRESSURE PRESSION DES PNEUS A FROID	SEE OWNER'S MANUAL FOR ADDITIONAL INFORMATION
FRONT AVANT	255/40 ZR18 99Y XL	200 KPA, 29 PSI	VOIR LE MANUEL DE L'USAGER POUR PLUS DE RENSEIGNEMENTS
REAR ARRIERE	285/35 ZR18 101Y XL	200 KPA, 29 PSI	
SPARE DE SECOURS	175/55-18 95P	420 KPA, 60 PSI	

i The data shown in the illustration is example data.

The Tire and Loading Information placard shows:

- Maximum number of seats 2 according to the maximum number of people permitted to travel in the vehicle.
- Maximum permissible load 3 comprises the gross weight of all vehicle occupants, load and luggage.

- Recommended tire pressures 1 for cold tires. The recommended tire pressures are valid for the maximum permissible load and up to the maximum permissible vehicle speed.

Please also note:

- Information on permissible weights and loads on the vehicle identification plate (→ page 355).
- Information on tire pressure in the tire pressure table (→ page 323).

Further related subjects:

- Determining the maximum permissible load (→ page 327)
- Notes on tire pressure (→ page 321).

### Steps for Determining Correct Load Limit

The following steps have been developed as required of all manufacturers under Title 49, Code of U.S. Federal Regulations, Part 575, pursuant to the "National Traffic and Motor Vehicle Safety Act of 1966".

- ▶ **(1):** Locate the statement "The combined weight of occupants and cargo should never exceed XXX kg or XXX lbs." on your vehicle's placard.
- ▶ **(2):** Determine the combined weight of the driver and passengers that will be riding in your vehicle.
- ▶ **(3):** Subtract the combined weight of the driver and passengers from XXX kg or XXX lbs.
- ▶ **(4):** The resulting figure equals the available amount of cargo and luggage load capacity. For example: if "XXX" equals 1,400 lbs and there are five occupants in your vehicle with a weight of 150 lbs each, the maximum cargo and luggage load capacity is 650 lbs (1,400 - 750 (5 x 150) = 650 lbs).
- ▶ **(5):** Determine the combined weight of luggage and cargo being loaded on the vehicle. The weight may not safely exceed the available cargo and luggage load capacity calculated in step 4.
- ▶ **(6):** If your vehicle will be towing a trailer, load from your trailer will be transferred to

your vehicle. Consult this manual to determine how much this reduces the available cargo and luggage load capacity of your vehicle.

- ❗ Not all vehicles are permitted to tow a trailer. Towing a trailer is only permitted if a trailer-hitch is installed. Please consult an authorized Mercedes-Benz dealer if you have any questions about towing a trailer with your vehicle.

Even if you have calculated the total load carefully, you should still make sure that the maximum permissible gross weight and the maximum gross axle weight rating of your vehicle are not exceeded. Details can be found on the vehicle identification plate.

- ▶ Have your loaded vehicle – including driver, occupants and load – weighed on a vehicle weighbridge. The measured values may not exceed the maximum permissible values stated on the vehicle identification plate.

Further related subjects:

- Calculation example for determining the maximum load (→ page 328)
- Tire and Loading Information placard (→ page 326)
- Tire pressure table (→ page 323)
- Vehicle identification plate (→ page 355)

#### Calculation example for determining the maximum load

The following table shows examples of how to calculate total and load capacities with varying seating configurations and different numbers and sizes of occupants. The following examples use a maximum load of 1500 lbs (680 kg). **This is for illustration purposes only.** Make sure you are using the actual load limit for your vehicle stated on your vehicle's Tire and Loading Information placard (→ page 326).

The higher the weight of all the occupants, the smaller the maximum load for luggage.

**Step 1**

	Example 1	Example 2
Combined maximum weight of occupants and load (data from the Tire and Loading Information placard)	1500 lbs (680 kg)	1500 lbs (680 kg)

**Step 2**

	Example 1	Example 2
Number of people in the vehicle (driver and occupants)	5	1
Distribution of the occupants	Front: 2 Rear: 3	Front: 1
Weight of occupants	Occupant 1: 150 lbs (68 kg) Occupant 2: 180 lbs (82 kg) Occupant 3: 160 lbs (73 kg) Occupant 4: 140 lbs (63 kg) Occupant 5: 120 lbs (54 kg)	Occupant 1: 200 lbs (91 kg)
Total weight of all occupants	750 lbs (340 kg)	200 lbs (91 kg)

### 330 Wheels and tires

---

#### Step 3

	Example 1	Example 2
Permissible load (maximum gross vehicle weight rating from the Tire and Loading Information placard minus the gross weight of all occupants)	$1500 \text{ lbs (680 kg)} - 750 \text{ lbs (340 kg)} = 750 \text{ lbs (340 kg)}$	$1500 \text{ lbs (680 kg)} - 200 \text{ lbs (91 kg)} = 1300 \text{ lbs (589 kg)}$

## Tire labeling

### Overview of tire labeling

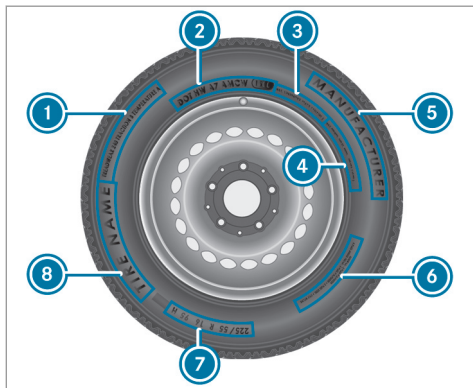

- ① Uniform Tire Quality Grading Standard (→ page 331)
- ② DOT, Tire Identification Number (→ page 332)
- ③ Maximum tire load (→ page 333)
- ④ Maximum tire pressure (→ page 333)

- ⑤ Manufacturer
  - ⑥ Characteristics of the tire (→ page 334)
  - ⑦ Tire size designation, load-bearing capacity, speed rating and load index (→ page 334)
  - ⑧ Tire name
- ① The data shown in the image is example data.

### Tire Quality Grading

In accordance with the US Department of Transportation's "Uniform Tire Quality Grading Standards", tire manufacturers are required to grade their tires on the basis of the following three performance factors:

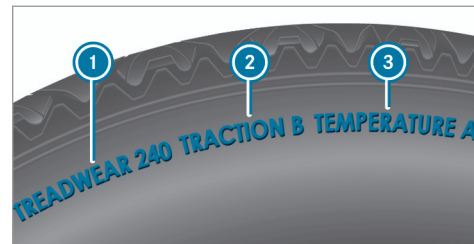

- ① Tread wear grade
  - ② Traction grade
  - ③ Temperature grade
- ① The data shown in the illustration is example data.
- ① The classification is not legally stipulated for Canada, but it is generally stated.

### Tread wear grade

The tread wear grade is a comparative rating based on the wear rate of the tire when tested under controlled conditions on a specified test track of the US Department of Transportation. For example, a tire graded 150 would wear one

and one-half times as well on the government test track as a tire graded 100.

The relative performance of tires depends upon the actual conditions of their use, however, and may depart significantly from the norm due to variations in driving habits, service practices and differences in road characteristics and climate conditions.

### Traction grade

**⚠ DANGER** Risk of accident due to inadequate traction

The traction grade assigned to this tire is based on straight-ahead braking traction tests, and does not include either acceleration, cornering, hydroplaning or peak traction characteristics.

- ▶ Always adapt your driving style and drive at a speed to suit the prevailing traffic and weather conditions.

**!** **NOTE** Damage to the drivetrain from wheelspin

- ▶ Avoid wheelspin.

The traction classes, from highest to lowest, are AA, A, B and C. Those grades represent the tire's ability to stop on wet pavement as measured under controlled conditions on specified government test surfaces of asphalt and concrete. A tire marked C may have poor traction performance.

### Temperature grade

**⚠ WARNING** Risk of accident from tire overheating and tire failure

The temperature grade for this tire is established for a tire that is properly inflated and not overloaded. Excessive speed, underinflation, or excessive loading, either separately or in combination, can cause excessive heat build-up and possible tire failure.

- ▶ Observe the recommended tire pressures and regularly check the tire pres-

sure of all tires including the spare wheel.

- ▶ Adjust the tire pressure as necessary.

The temperature grades are A (the highest), B and C. They represent the tire's resistance to the generation of heat and its ability to dissipate heat when tested under controlled conditions on a specified indoor laboratory test wheel. Sustained high temperature can cause the material of the tire to degenerate and reduce tire life, and excessive temperature can lead to sudden tire failure. Grade C corresponds to a level of performance which all passenger car tires must meet under the Federal Motor Safety Standard No. 109. Grades B and A represent higher levels of performance on the laboratory test wheel than the minimum required by law.

### DOT, Tire Identification Number (TIN)

US tire regulations stipulate that every tire manufacturer or retreader must imprint a TIN in or on the side wall of each tire produced.



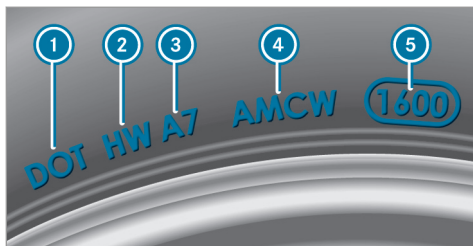

**i** The data shown in the image is example data.

The TIN is a unique identification number to identify tires and comprises the following:

- **DOT (Department of Transportation):** tire symbol marks **1** indicating that the tire complies with the requirements of the US Department of Transportation.
- **Manufacturer identification code:** manufacturer identification code **2** contains details of the tire manufacturer. New tires have a code with two symbols. Retreaded tires have a code with four symbols. Further information on retreaded tires (→ page 339).

- **Tire size:** identifier **3** describes the tire size.
- **Tire type code:** tire type code **4** can be used by the manufacturer as a code to describe specific characteristics of the tire.
- **Manufacturing date:** manufacturing date **5** provides information about the age of a tire. The 1st and 2nd positions represent the calendar week and the 3rd and 4th positions state the year of manufacture (e.g. "3208" represents the 32nd week of 2008).

#### Information on the maximum tire load

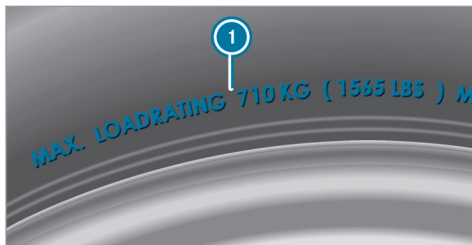

**i** The data shown in the image is example data.

Maximum tire load **1** is the maximum permissible weight for which the tire is approved.

Do not overload the tires by exceeding the specified load limit. The maximum permissible load can be found on the vehicle's Tire and Loading Information placard on the B-pillar on the driver's side (→ page 326).

#### Specifications for maximum tire pressure

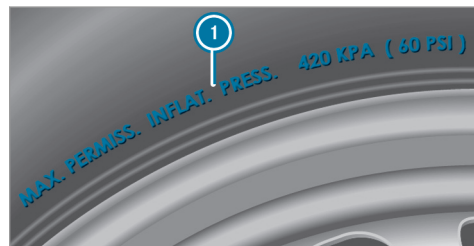

**i** The data shown in the image is example data.

Never exceed maximum tire pressure ❶ specified for the tire.

### Information on tire characteristics



❶ The data shown in the image is example data.

This information describes the type of tire cord and the number of layers in side wall ❶ and under tire tread ❷.

### Tire size designation, load-bearing capacity, speed rating and load index

**⚠ WARNING** Risk of injury through exceeding the specified tire load rating or the permissible speed rating

Exceeding the specified tire load rating or the permissible speed rating may lead to tire damage and to the tires bursting.

- ▶ Therefore, only use tire types and sizes approved for your vehicle model.
- ▶ Observe the tire load rating and speed rating required for your vehicle.

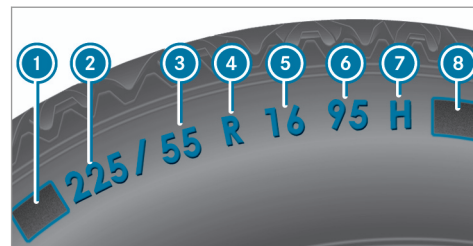

- ❶ Preceding letter
- ❷ Nominal tire width in millimeters
- ❸ Aspect ratio in %
- ❹ Tire code
- ❺ Rim diameter
- ❻ Load-bearing index
- ❼ Speed rating
- ❽ Load index

❶ The data shown in the image is example data.

Information about reading tire data can be obtained from any qualified specialist workshop.

**Preceding letter 1:**

- Without: passenger vehicle tires according to European manufacturing standards.
- "P": passenger vehicle tires according to US manufacturing standards.
- "LT": light truck tires according to US manufacturing standards.
- "T": compact emergency spare wheels with high tire pressure that are only designed for temporary use in an emergency.

**Aspect ratio 2:**

Ratio between tire height and tire width in percent (tire height divided by tire width).

**Tire code 3 (tire type):**

- "R": radial tire
- "D": bias ply tire
- "B": bias belted tires
- "ZR": radial tire with a maximum speed above 149 mph (240 km/h) (optional)

**Rim diameter 5:**

The diameter of the bead seat (not the diameter of the rim flange). The rim diameter is specified in inches (in).

**Load-bearing index 6:**

Numerical code that specifies the maximum load-bearing capacity of a tire (e.g. "91" corresponds to 1356 lbs (615 kg)).

The load-bearing capacity of the tire must be at least half the permissible axle load of your vehicle. Do not overload the tires by exceeding the specified load limit.

See also:

- Maximum permissible load on the Tire and Loading Information placard (→ page 326)
- Maximum tire load (→ page 333)
- Load index

**Speed rating 7:**

Specifies the approved maximum speed of the tire.





- **i** An electronic speed limiter prevents your vehicle from exceeding a speed of 130 mph (210 km/h).

Make sure that your tires have the required speed rating. You can obtain information on the required speed rating from an authorized Mercedes-Benz Center.

**Summer tires**

Index	Speed rating
Q	up to 100 mph (160 km/h)
R	up to 106 mph (170 km/h)
S	up to 112 mph (180 km/h)
T	up to 118 mph (190 km/h)
H	up to 130 mph (210 km/h)
V	up to 149 mph (240 km/h)
W	up to 168 mph (270 km/h)
Y	up to 186 mph (300 km/h)

Index	Speed rating
ZR...Y <sup>4</sup>	up to 186 mph (300 km/h)
ZR...(..Y) <sup>4</sup>	over 186 mph (300 km/h)
ZR <sup>4</sup>	over 149 mph (240 km/h)

- Specifying the speed rating as the "ZR" index in tire code  is optional for tires up to 186 mph (300 km/h).
- If your tire code  includes "ZR" and there is no speed rating , find out what the maximum speed is from the tire manufacturer.
- If load-bearing index  and speed rating  are in brackets, the maximum speed rating of your tire is above 186 mph (300 km/h). To find out the maximum speed, ask the tire manufacturer.

<sup>4</sup> "ZR" stated in the tire code.

<sup>5</sup> Or "M+S"  " for winter tires

### All-weather tires and winter tires

Index	Speed rating
Q M+S <sup>5</sup>	up to 100 mph (160 km/h)
T M+S <sup>5</sup>	up to 118 mph (190 km/h)
H M+S <sup>5</sup>	up to 130 mph (210 km/h)
V M+S <sup>5</sup>	up to 149 mph (240 km/h)

Winter tires bear the  snowflake symbol and fulfill the requirements of the Rubber Manufacturers Association (RMA) and the Rubber Association of Canada (RAC) regarding the tire traction on snow.

### Load index :

- No specification given: standard load (SL) tire
- "XL" or "Extra Load": extra load tire or reinforced tire
- "Light Load": light load tire

- "C", "D", "E": a load range that depends on the maximum load that the tire can carry at a certain pressure

### Definition of terms for tires and loading

**Tire structure and characteristics:** describes the number of layers or the number of rubber-coated belts in the tire contact surface and the tire wall. These are made of steel, nylon, polyester and other materials.

**Bar:** metric unit for tire pressure.

14.5038 pounds per square inch (psi) and 100 kilopascal (kPa) is the equivalent of one bar.

**DOT (Department of Transportation):** DOT-marked tires fulfill the requirements of the US Department of Transportation.

**Average weight of the vehicle occupants:** the number of vehicle occupants for which the vehicle is designed, multiplied by 150 lb (68 kg).

**Uniform Tire Quality Grading Standards:** a uniform standard to grade the quality of tires with regard to tread quality, tire traction and temperature characteristics. The quality grading assessment is made by the manufacturer following specifications from the U.S. government. The quality grade of a tire is imprinted on the side wall of the tire.

**Recommended tire pressure:** the recommended tire pressure is the tire pressure specified for the tires mounted to the vehicle at the factory.

The tire and information table contains the recommended tire pressures for cold tires, the maximum permissible load and the maximum permissible vehicle speed.

The tire pressure table contains the recommended tire pressures for cold tires under various operating conditions, i.e. loading and/or speed of the vehicle.

**Increased vehicle weight due to optional equipment:** the combined weight of all standard and optional equipment available for the vehicle,

regardless of whether it is actually installed on the vehicle or not.

**Rim:** the part of the wheel on which the tire is installed.

**GAWR (Gross Axle Weight Rating):** the GAWR is the maximum permissible axle load. The actual load on an axle must never exceed the gross axle weight rating. The gross axle weight rating can be found on the vehicle identification plate on the B-pillar on the driver's side.

**Speed rating:** the speed rating is part of the tire identification. It specifies the speed range for which a tire is approved.

**GVW (Gross Vehicle Weight):** the gross vehicle weight comprises the weight of the vehicle including fuel, tools, the spare wheel, accessories installed, occupants, luggage and the trailer drawbar noseweight, if applicable. The gross vehicle weight must not exceed the gross vehicle weight rating GVWR as specified on the vehicle identification plate on the B-pillar on the driver's side.

**GVWR (Gross Vehicle Weight Rating):** the GVWR is the maximum permitted gross weight

of the fully laden vehicle (weight of the vehicle including all accessories, occupants, fuel, luggage and the trailer drawbar noseweight if applicable). The gross vehicle weight rating is specified on the vehicle identification plate on the B-pillar on the driver's side.

**Maximum weight of the laden vehicle:** the maximum weight is the sum of the curb weight of the vehicle, the weight of the accessories, the maximum load and the weight of optional equipment installed at the factory.

**Kilopascal (kPa):** metric unit for tire pressure. 6.9 kPa corresponds to 1 psi. Another unit for tire pressure is bar. 100 kilopascal (kPa) equals 1 bar.

**Load index:** in addition to the load-bearing index, the load index may also be imprinted on the side wall of the tire. This specifies the load-bearing capacity of the tire more precisely.

**Curb weight:** the weight of a vehicle with standard equipment including the maximum capacity of fuel, oil and coolant. It also includes the air conditioning system and optional equipment if

these are installed on the vehicle, but does not include passengers or luggage.

**Maximum tire load:** the maximum tire load is the maximum permissible weight in kilograms or lbs for which a tire is approved.

**Maximum permissible tire pressure:** maximum permissible tire pressure for one tire.

**Maximum load on one tire:** maximum load on one tire. This is calculated by dividing the maximum axle load of one axle by two.

**PSI (pounds per square inch):** standard unit of measurement for tire pressure.

**Aspect ratio:** ratio between tire height and tire width in percent.

**Tire pressure:** pressure inside the tire applying an outward force to every square inch of the tire. The tire pressure is specified in pounds per square inch (psi), in kilopascals (kPa) or in bar. The tire pressure should only be corrected when the tires are cold.

**Cold tire pressure:** the tires are cold when the vehicle has been parked for at least 3 hours

without direct sunlight on the tires or the vehicle has been driven for less than 1 mile (1.6 km).

**Tire contact surface:** the part of the tire that comes into contact with the road.

**Tire bead:** the purpose of the tire bead is to ensure that the tire sits securely on the wheel rim. There are several wire cores in the tire bead to prevent the tire from changing length on the wheel rim.

**Side wall:** the part of the tire between the tread and the tire bead.

**Weight of optional equipment:** the combined weight of the optional equipment weighing more than the replaced standard parts and more than 5 lbs (2.3 kg). This optional equipment, such as high-performance brakes, level control system, a roof luggage rack or high-performance batteries, is not included in the curb weight and the weight of the accessories.

**TIN (Tire Identification Number):** a unique identification number which can be used by a tire manufacturer to identify tires, for example, in a product recall, and thus identify the purchasers. The TIN is made up of the manufactur-

er's identity code, tire size, tire type code and the manufacturing date.

**Load-bearing index:** the load-bearing index is a code that contains the maximum load-bearing capacity of a tire.

**Traction:** traction is the grip resulting from friction between the tires and the road surface.

**Wear indicator:** narrow bars (tread wear bars) that are distributed over the tire contact surface. If the tire tread is level with the bars, the wear limit of 1/16 in (1.6 mm) has been reached.

**Distribution of vehicle occupants:** distribution of vehicle occupants over designated seat positions in a vehicle.

**Maximum permissible payload weight:** nominal load and luggage load plus 150 lb (68 kg) multiplied by the number of seats in the vehicle.

## Changing a wheel

### Notes on selecting, installing and replacing tires

**Mercedes-AMG vehicles:** observe the notes in the Supplement. You could otherwise fail to recognize dangers.

**⚠ WARNING** Risk of accident due to incorrect dimensions of wheels and tires

If wheels and tires of the wrong size are installed, the wheel brakes or wheel suspension components may be damaged.

- ▶ Always replace wheels and tires with those that fulfill the specifications of the original part.

When replacing wheels, make sure to fit the correct:

- Designation
- Model

When replacing tires, make sure to install the correct:

- Designation
- Manufacturer
- Model

**⚠ WARNING** Risk of injury through exceeding the specified tire load-bearing capacity or the permissible speed rating

Exceeding the specified tire load rating or the permissible speed rating may lead to tire damage and to the tires bursting.

- ▶ Therefore, only use tire types and sizes approved for your vehicle model.
- ▶ Observe the tire load rating and speed rating required for your vehicle.

**! NOTE** Vehicle and tire damage through tire types and sizes that have not been approved

For safety reasons, only use tires, wheels and accessories which have been specially approved by Mercedes-Benz for your vehicle.

These tires are specially adapted to the control systems, such as ABS, ESP<sup>®</sup> and 4MATIC, and marked as follows:

- MO = Mercedes-Benz Original
- MOE = Mercedes-Benz Original Extended (run-flat tire only for certain wheels)
- MO1 = Mercedes-Benz Original (only certain AMG tires)

Certain characteristics, such as handling, vehicle noise emissions, consumption, etc. may otherwise be adversely affected. Furthermore, other tire sizes could result in the tires rubbing against the body and axle components when loaded. This could result in damage to the tire or the vehicle.

Only use tires, wheels and accessories that have been checked and recommended by Mercedes-Benz.

**!** **NOTE** Risk to driving safety from retreaded tires

Retreaded tires are neither tested nor recommended by Mercedes-Benz, since previous damage cannot always be detected on retreaded tires.

For this reason driving safety cannot be guaranteed.

- ▶ Do not use used tires if you have no information about their previous usage.

**!** **NOTE** Possible damage to wheels or tires when driving over obstacles

Large wheels have a lower tire section width. The lower the tire section width, the greater is the risk of damage to wheels or tires when driving over obstacles.

- ▶ Avoid obstacles or drive particularly carefully.

**!** **NOTE** Possible wheel and tire damage when parking on curbs or in potholes

Parking on curbs or in potholes may damage the wheels and tires.

- ▶ If possible, park only on flat surfaces.
- ▶ Avoid curbs and potholes when parking.

**!** **NOTE** Damage to electronic component parts from the use of tire-mounting tools

**Vehicles with a tire pressure monitoring system:** Electronic component parts are located in the wheel. Tire-mounting tools should not be used in the area of the valve.

This could otherwise damage the electronic component parts.

- ▶ Have the tires changed at a qualified specialist workshop only.

**!** **NOTE** Damage to summer tires at low ambient temperatures

At low ambient temperatures, tears could form when driving with summer tires, causing permanent damage to the tires.

- ▶ At temperatures below 45 °F (7 °C), use M+S tires .

Accessory parts that are not approved for your vehicle by Mercedes-Benz or are not being used correctly can impair the operating safety.

Before purchasing and using non-approved accessories, visit a qualified specialist workshop and inquire about:

- Suitability
- Legal stipulations
- Factory recommendations

**⚠** **WARNING** Risk of accident with high performance tires

There is an increased risk of skidding and hydroplaning when using sport tires on wet roads.



In addition, the tire grip is greatly reduced at a low outside temperature and tire running temperature.

- ▶ Activate ESP® and adapt your driving style accordingly.
- ▶ Use M+S tires at outside temperatures below 50 °F (10 °C).
- ▶ Only use the tires for their intended purpose.

Observe the following when selecting, installing and replacing tires:

- Furthermore, the use of certain tire types in certain regions and areas of operation can be highly beneficial.
- Only use tires and wheels of the same type (summer tires, winter tires, MOExtended tires) and the same make.
- Only install wheels of the same size on one axle (left and right).

It is only permissible to install a different wheel size in the event of a flat tire in order to drive to the specialist workshop.

- **Vehicles with a tire pressure monitoring system:** All installed wheels must be equipped with functioning sensors for the tire pressure monitoring system.
- At temperatures below 45 °F (7 °C) use winter tires or all-season tires marked M+S for all wheels.

Winter tires bearing the  snowflake symbol in addition to the M+S marking provide the best possible grip in wintry road conditions.

- For M+S tires, only use tires with the same tread.
- Observe the maximum permissible speed for the M+S tires installed.  
If the tire's maximum speed is below that of the vehicle, this must be indicated by an appropriate label in the driver's field of vision.
- Break in new tires at moderate speeds for the first 60 miles (100 km).
- Replace the tires after six years at the latest, regardless of wear.

- **When replacing with tires that do not feature run-flat characteristics:** vehicles with MOExtended tires are not equipped with a TIREFIT kit at the factory. Equip the vehicle with a TIREFIT kit after replacing with tires that do not feature run-flat characteristics, e.g. winter tires.

For more information on wheels and tires, contact a qualified specialist workshop.

Be sure to also observe the following further related subjects:

- Notes on tire pressure (→ page 321)
- Tire and Loading Information placard (→ page 326)
- Tire size designation, load-bearing capacity, speed rating and load index (→ page 334)
- Tire pressure table (→ page 323)
- Notes on the emergency spare wheel (→ page 348)

### Notes on rotating wheels

**⚠ WARNING** Risk of injury through different wheel sizes

Interchanging the front and rear wheels if the wheels or tires have different dimensions may severely impair the driving characteristics.

The wheel brakes or wheel suspension components may also be damaged.

- ▶ Rotate front and rear wheels only if the wheels and tires are of the same dimensions.

The wear patterns on the front and rear wheels differ:

- Front wheels wear more on the shoulder of the tire
- Rear wheels wear more at the center of the tire

Do not drive with tires that have too little tread depth. This significantly reduces traction on wet roads (hydroplaning).

On vehicles that have the same size front and rear wheels, rotate the wheels according to the intervals in the tire manufacturer's warranty book in your vehicle documents. If this is not available, rotate the tires every 3,000 to 6,000 miles (5,000 to 10,000 km), depending on the wear. Ensure that the direction of rotation is maintained.

Observe the instructions and safety notes on "Changing a wheel" when doing so (→ page 343).

### Notes on storing wheels

When storing wheels, observe the following notes:

- After removing wheels, store them in a cool, dry and preferably dark place.
- Protect the tires from contact with oil, grease or fuel.

### Overview of the tire-change tool kit

Apart from some country-specific variants, vehicles are not equipped with a tire-change tool kit.

For more information on which tools are required and approved to perform a wheel change on your vehicle, consult a qualified specialist workshop.

Required tire-change tools may include, for example:

- Jack
- Chock
- Lug wrench

Tire-change tool kit ① is located under the cargo compartment floor.

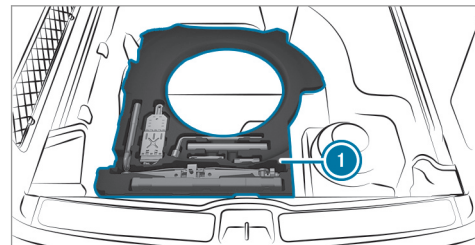

The tire-change tool kit includes the following:

- Jack

- Lug wrench
- Wheel studs
- Extension attachment for wheel studs, if necessary (depending on vehicle version)
- Folding chock
- Ratchet wrench

### Preparing the vehicle for a wheel change

#### Requirements:

- The required tire-change tool is available. If your vehicle is not equipped with the tire-change tool kit, consult a qualified specialist workshop to find out about suitable tools.
  - The vehicle is not on a slope.
  - The vehicle is on solid, non-slippery and level ground.
- ▶ Apply the electric parking brake manually.
  - ▶ Move the front wheels to the straight-ahead position.
  - ▶ Shift the transmission to position **P**.

- ▶ **Vehicles with level control system:** Set the normal vehicle level (→ page 203).
- ▶ Switch off the engine.
- ▶ Make sure that the engine cannot be started.
- ▶ Place chocks or other suitable items under the front and rear of the wheel that is diagonally opposite the wheel you wish to change.
- ▶ Raise the vehicle (→ page 344).

### Removing and installing hub caps

#### Requirements:

- The vehicle is prepared for a wheel change (→ page 343).

#### Plastic hub cap

- ▶ **To remove:** turn the center cover of the hub cap counter-clockwise and remove the hub cap.
- ▶ **To install:** make sure that the center cover of the hub cap is turned counter-clockwise.
- ▶ Position the hub cap and turn the center cover clockwise until the hub cap engages physically and audibly.

#### Aluminum hub cap

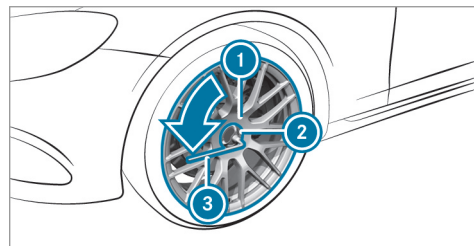

- ▶ **To remove:** position socket ② from the tire-change tool kit on hub cap ①.
  - ▶ Position wheel wrench ③ on socket ②.
  - ▶ Using wheel wrench ③, turn hub cap ① counter-clockwise and remove it.
  - ▶ **To install:** follow the instructions above in reverse order.
- i** **Specified tightening torque:** 18 lb-ft (25 Nm).

### Raising the vehicle when changing a wheel

#### Requirements:

- There are no persons in the vehicle.
- The vehicle has been prepared for a wheel change (→ page 343).

#### Important notes on using the jack:

- Use only a vehicle-specific jack that has been approved by Mercedes-Benz to raise the vehicle.
- The jack is only designed for raising and holding the vehicle for a short time while a wheel is being changed and not for maintenance work under the vehicle.
- The jack must be placed on a firm, flat and non-slip surface. If necessary, use a large, flat, load-bearing, non-slip underlay.
- The foot of the jack must be positioned vertically under the jack support point.

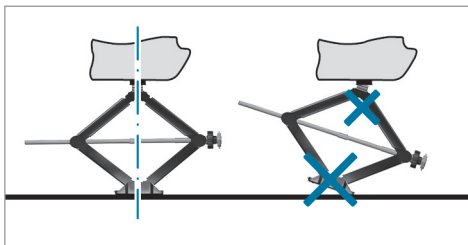

#### Rules of conduct when the vehicle is raised:

- Never place your hands or feet under the vehicle.
- Never lie under the vehicle.
- Do not start the engine and do not release the electric parking brake.
- Do not open or close any doors or the tail-gate.

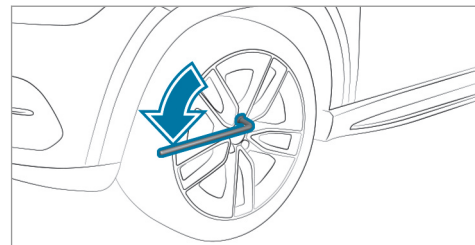

- ▶ Using the lug wrench, loosen the wheel bolts on the wheel you wish to change by about one full turn. Do not unscrew the bolts completely.

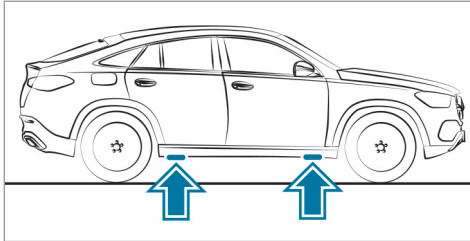

Position of jack support points

**⚠ WARNING** Risk of injury from incorrect positioning of the jack

If you do not position the jack correctly at the appropriate jacking point of the vehicle, the jack could tip with the vehicle raised.

- ▶ Only position the jack at the appropriate jacking point of the vehicle. The base of the jack must be positioned vertically under the jacking point of the vehicle.

**!** **NOTE** Vehicle damage from the jack

If you do not position the jack correctly at the appropriate jack support point of the vehicle, the jack could tip over with the vehicle raised.

- ▶ The jack is designed exclusively for jacking up the vehicle at the jack support points.
- ▶ Take the ratchet wrench out of the tire-change tool kit and place it on the hexagon nut of the jack so that the letters "AUF" are visible.

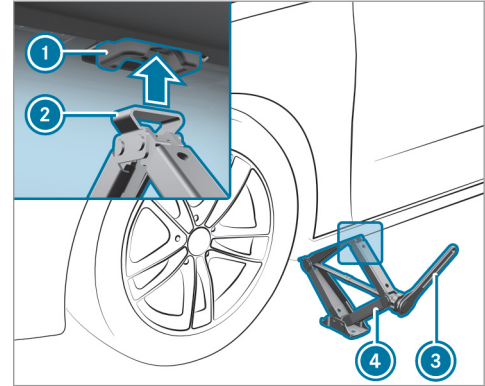

- ▶ Position jack **2** at jack support point **1**.
- ▶ Turn ratchet wrench **3** clockwise until jack **2** sits completely on jack support point **1** and the base of the jack lies evenly on the ground.
- ▶ Continue to turn ratchet wrench **3** until the tire is raised a maximum of 1.2 in (3 cm) off the ground.
- ▶ Loosen and remove the wheel (→ page 346).

### Removing a wheel

#### Requirements:

- The vehicle is raised (→ page 344).

**Mercedes-AMG vehicles:** observe the notes in the Supplement. You could otherwise fail to recognize dangers.

When changing a wheel, avoid applying any force to the brake discs, since this could impair the level of comfort when braking.

**NOTE** Damage to threading from dirt on wheel bolts

- ▶ Do not place wheel bolts in sand or on a dirty surface.

- ▶ Completely unscrew the wheel bolts.
- ▶ Remove the wheel.

### Mounting a new wheel

#### Requirements:

- The wheel is removed (→ page 346).

**Mercedes-AMG vehicles:** observe the notes in the Supplement. Otherwise, you may not recognize dangers.

**WARNING** Risk of accident from losing a wheel

Oiled, greased or damaged wheel bolt/wheel nut threads or wheel hub/wheel mounting bolt threads can cause the wheel bolts/wheel nuts to come loose.

As a result, you could lose a wheel while driving.

- ▶ Never oil or grease the threads.
- ▶ In the event of damage to the threads, contact a qualified specialist workshop immediately.
- ▶ Have the damaged wheel bolts or damaged hub threads replaced.
- ▶ Do not continue driving.

- ▶ Observe the information on the choice of tires (→ page 339).

For tires with a specified direction of rotation, an arrow on the side wall of the tire indicates the correct direction of rotation. Observe the direction of rotation when installing.

**WARNING** Risk of injury from tightening wheel bolts and nuts

If you tighten the wheel bolts or wheel nuts when the vehicle is raised, the jack could tip.

- ▶ Only tighten wheel bolts or wheel nuts when the vehicle is on the ground.

- ▶ Be sure to observe the instructions and safety notes on "Changing a wheel" (→ page 339).
- ▶ For safety reasons, only use wheel bolts which have been approved by Mercedes-Benz and for the wheel in question.

**NOTE** Damage to paintwork of the wheel rim when screwing on the first wheel bolt

If the wheel has too much play when screwing in the first wheel bolt, the wheel rim paint can be damaged.

- ▶ Press the wheel firmly against the wheel hub when screwing on the first wheel bolt.

- ▶ Tighten the wheel bolts evenly in a diagonal pattern in the order indicated until they are finger-tight.
- ▶ If the collapsible spare wheel has been installed, inflate the collapsible spare wheel (→ page 351).
- ▶ Lower the vehicle (→ page 347).

### Lowering the vehicle after a wheel change

#### Requirements:

- The new wheel has been installed (→ page 346).

Observe the information on tire pressure (→ page 321).

- ▶ Place the ratchet wrench onto the hexagon nut of the jack so that the lettering "AB" is visible.

- ▶ **To lower the vehicle:** turn the ratchet wrench of the jack counter-clockwise.

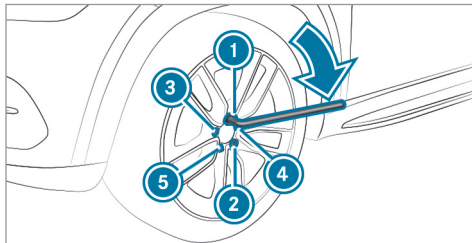

- ▶ Tighten the wheel bolts evenly in a diagonal pattern in the order indicated ① to ⑤ with a maximum of 59 lb-ft (80 Nm).
- ▶ Then tighten the wheel bolts evenly in a diagonal pattern in the order indicated ① to ⑤ to the specified tightening torque of 111 lb-ft (150 Nm).

- ▶ **WARNING** Risk of injury through incorrect tightening torque

The wheels could come loose if the wheel bolts or wheel nuts are not tightened to the prescribed tightening torque.

- ▶ Make sure the wheel bolts or wheel nuts are tightened to the prescribed tightening torque.
- ▶ If you are not sure, do not move the vehicle. Consult a qualified specialist workshop and have the tightening torque checked immediately.
- ▶ Check the tire pressure of the newly mounted wheel and adjust accordingly.
- ▶ **Vehicles with a tire pressure monitoring system:** Restart the tire pressure monitoring system (→ page 326).
- ▶ **Exception:** the new wheel is an emergency spare wheel.

## Emergency spare wheel

### Notes on the emergency spare wheel

**⚠ WARNING** Risk of accident caused by incorrect wheel and tire dimensions

The wheel or tire size and the tire type of the emergency spare wheel or spare wheel and the wheel to be replaced may differ. The emergency spare wheel or spare wheel can significantly impair driving characteristics of the vehicle.

To prevent hazardous situations:

- ▶ Adapt your driving style accordingly and drive carefully.
- ▶ Never install more than one emergency spare wheel or spare wheel that differs in size.
- ▶ Only use an emergency spare wheel or spare wheel of a different size briefly.
- ▶ Do not switch off ESP®.
- ▶ Have the emergency spare wheel or spare wheel of a different size replaced at the nearest qualified specialist work-

shop. The new wheel must have the correct dimensions.

**i** The emergency spare wheel is fastened in the cargo compartment under the cargo compartment floor.

**i** Not for Mercedes-Maybach vehicles.

Observe the following notes on removing an emergency spare wheel:

- Before stowing the emergency spare wheel, make sure there is no air left in the tire. If necessary, allow the air to escape.
- **To release air from the tire:** remove the valve cap of the tire.
- Press down the metal insert in the valve using a pointed object, e.g. a pen.
- Screw the valve cap onto the valve.

Observe the following notes on installing an emergency spare wheel:

- Check the tire pressure of the emergency spare wheel installed. Correct the pressure as necessary.

- The maximum permissible speed with an emergency spare wheel installed is 50 mph (80 km/h).
- Do not install snow chains on the emergency spare wheel.
- Replace the emergency spare wheel after six years at the latest, regardless of wear.

**i Vehicles with a tire pressure monitoring system:** If an emergency spare wheel is installed, the tire pressure monitoring system cannot function reliably. For a few minutes after an emergency spare wheel is installed, the system may still display the tire pressure of the removed wheel. Only restart the system again when the emergency spare wheel has been replaced with a new wheel.

Be sure to also observe the following further related subjects:

- Notes on tire pressure (→ page 321)
- Tire and Loading Information placard (→ page 326)
- Tire pressure table (→ page 323)
- Notes on installing tires (→ page 339)



## Inflating the emergency spare wheel

**!** **NOTE** Overheating due to the tire inflation compressor running too long

▶ Do not run the tire inflation compressor for longer than ten minutes without interruption.

### Requirements:

Comply with the manufacturer's safety notes on the sticker of the emergency spare wheel and on the tire inflation compressor.

- ▶ Remove sticker with the label 50 mph (80 km/h ) from the tire inflation compressor housing and affix it to the instrument cluster within the driver's field of vision.
- ▶ Remove the tire inflation compressor from the stowage space under the cargo compartment floor (→ page 303).

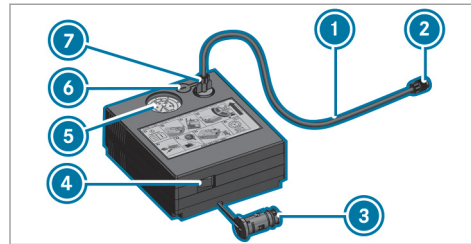

- ▶ Pull filler hose ① and plug ③ out of the tire inflation compressor housing.
- ▶ Insert plug ⑦ of filler hose ① in the socket on the tire inflation compressor and then turn it until plug ⑦ engages.
- ▶ Unscrew the cap from the valve on the emergency spare wheel.
- ▶ Screw union nut ② of filler hose ① onto valve.
- ▶ Make sure on and off switch ④ of the tire inflation compressor is set to **0**.
- ▶ Insert plug ③ in a socket in your vehicle.
  - Cigarette lighter socket

- 12 V socket: (→ page 115)
- Observe the notes on the cigarette lighter in the Digital Operator's Manual
- Observe the notes on sockets: (→ page 115)
- ▶ Press the start/stop button once to switch on the power supply. (→ page 143)
- ▶ Press On/Off switch ④ on the tire inflation compressor to **I**.  
The tire inflation compressor is switched on. The tire is inflated. The tire pressure is shown on manometer ⑤.
- ▶ Pump the tire to the specified tire pressure.
- ① The specified tire pressure is stated on the label of the emergency spare wheel.
- ▶ When the specified tire pressure has been reached, press on and off switch ④ on the tire inflation compressor to **0**.  
The tire inflation compressor is switched off.
- ▶ Press the start/stop button to switch off the power supply.
- ▶ If the tire pressure is higher than the specified pressure, press pressure release valve

button ⑥ until the correct tire pressure has been reached.

- ▶ Unscrew union nut ② of filler hose ① from the valve.
- ▶ Screw the valve cap of the emergency spare wheel onto the valve again.
- ▶ Stow filler hose ① and plug ③ in the lower section of the tire inflation compressor housing.
- ▶ Stow the tire inflation compressor in the vehicle.

### Collapsible spare wheel

#### Notes on the collapsible spare wheel

**▲ WARNING** Risk of accident caused by incorrect wheel and tire dimensions

The wheel or tire size and the tire type of the emergency spare wheel or spare wheel and the wheel to be replaced may differ. Mounting an emergency spare wheel/spare wheel may severely impair the driving characteristics.

To prevent hazardous situations:

- ▶ Adapt your driving style accordingly and drive carefully.
- ▶ Never mount more than one emergency spare wheel or spare wheel that differs in size.
- ▶ Only use an emergency spare wheel or spare wheel of a different size briefly.
- ▶ Do not switch off ESP®.
- ▶ >Have the emergency spare wheel or spare wheel of a different size replaced at the nearest qualified specialist workshop. The new wheel must have the correct dimensions.

The collapsible spare wheel is an emergency spare wheel which is only suitable for use for a limited period of time and in a restricted manner in the event of a flat tire (e.g. until the nearest workshop).

The tire sidewalls are folded when in transport mode. Before use, the collapsible spare wheel

has to be inflated with the accompanying compressor.

Check the tire pressure of the collapsible spare wheel once installed. Correct the pressure as necessary.

The maximum permissible speed with a collapsible spare wheel installed is 50 mph (80 km/h).

Do not install snow chains on the collapsible spare wheel.

Replace the collapsible spare wheel after six years at the latest, regardless of wear.

**i Vehicles with a tire pressure monitoring system:** If a collapsible spare wheel is installed the tire pressure monitoring system cannot function reliably. For a few minutes after an emergency spare wheel is installed, the system may still display the tire pressure of the removed wheel. Only restart the system again when the collapsible spare wheel has been replaced with a new wheel.

Be sure to also observe the following further related subjects:

- Notes on tire pressure (→ page 321)

- Tire pressure table (→ page 323)

### Removing the collapsible spare wheel

The collapsible spare wheel is located under the cargo compartment floor.

- ▶ Observe the information on mounting tires (→ page 339).
- ▶ Open the tailgate.
- ▶ Open the cargo compartment floor (→ page 112).
- ▶ Remove the collapsible spare wheel.

### Inflating the collapsible spare wheel

#### Requirements:

- Mount the collapsible spare wheel as described (→ page 346).
- Remove the tire inflation compressor from the storage well under the trunk floor (→ page 303).

**!** **NOTE** Damage to the collapsible spare wheel when lowering the vehicle

Lowering the vehicle without previously inflating the collapsible spare wheel can damage its rim.

- ▶ Inflate the collapsible spare wheel using the tire inflation compressor before lowering the vehicle.

**!** **NOTE** Overheating due to the tire inflation compressor running too long

- ▶ Do not run the tire inflation compressor for longer than ten minutes without interruption.

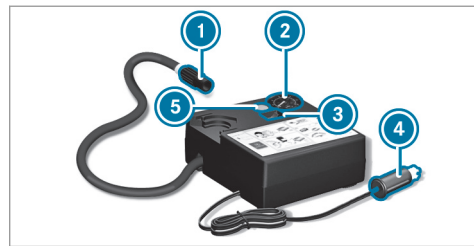

- ▶ Pull connector ④ and the hose out of the housing.
- ▶ Unscrew the cap from the valve on the collapsible spare wheel.
- ▶ Screw union nut ① of the hose onto the valve.  
Make sure on and off switch ③ of the tire inflation compressor is set to 0.
- ▶ Insert plug ④ into the cigarette lighter socket or into a 12 V socket (→ page 115) in your vehicle.
- ▶ Switch on the power supply (→ page 143).

## 352 Wheels and tires

---

- ▶ Press On/Off switch ③ on the tire inflation compressor to **I**.  
The tire inflation compressor is switched on.  
The tire is inflated. The tire pressure is shown on manometer ②.
- ▶ Pump the tire to the specified tire pressure.
- ① The specified tire pressure is printed on the yellow label of the collapsible spare wheel.
- ▶ When the specified tire pressure has been reached, press on/off switch ③ on the tire inflation compressor to **0**.
- ▶ If the tire pressure is higher than the specified pressure, press pressure release valve button ⑤ until the correct tire pressure has been reached.

### Notes on technical data

**Mercedes-AMG vehicles:** be sure to observe the notes in the Supplement. Otherwise, you may fail to recognize dangers.

The data stated only applies to vehicles with standard equipment. You can obtain further information from an authorized Mercedes-Benz Center.

### Vehicle electronics

#### Two-way radios

##### Notes on installing two-way radios

**⚠ WARNING** Risk of accident due to improper work on two-way radios

If two-way radios are manipulated or retrofitted incorrectly, the electromagnetic radiation from the two-way radios can interfere with the vehicle electronics and jeopardize the operating safety of the vehicle.

- ▶ You should have all work on electrical and electronic components carried out at a qualified specialist workshop.

**⚠ WARNING** Risk of accident from incorrect operation of two-way radios

If you operate two-way radios incorrectly in the vehicle, the electromagnetic radiation could interfere with the on-board electronics, for example, if:

- The tow-way radio is not connected to an exterior antenna
- If the exterior antenna is not correctly mounted or is not of low reflection

This could jeopardize the operating safety of the vehicle.

- ▶ Have the low-reflection exterior antenna installed at a qualified specialist workshop.
- ▶ When operating two-way radios in the vehicle, always connect them to the low-reflection exterior antenna.

**! NOTE** Invalidation of the operating permit due to failure to comply with the instructions for installation and use

The operating permit may be invalidated if the instructions for installation and use of two-way radios are not observed.

- ▶ Only use approved frequency bands.
- ▶ Observe the maximum permissible output power in these frequency bands.
- ▶ Only use approved antenna positions.

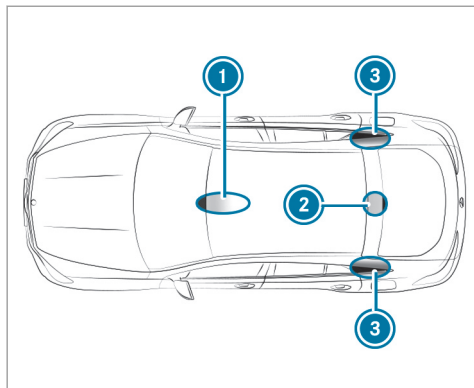

- ① Front roof area
- ② Rear roof area
- ③ Rear fenders

On vehicles with a panoramic sliding sunroof, installing an antenna to the front or rear roof area is not permitted.

On the rear fenders, it is recommended that you install the antenna on the side of the vehicle closest to the center of the road.

Use Technical Specification ISO/TS 21609 (Road Vehicles - "EMCs for installation of aftermarket radio frequency transmitting equipment") when retrofitting two-way radios. Comply with the legal requirements for detachable parts.

If your vehicle has installing for two-way radio equipment, use the power supply and antenna connectors provided in the pre-installation. Observe the manufacturer's supplements when installing.

#### Two-way radio transmission output

The maximum transmission output (PEAK) at the base of the antenna must not exceed the values in the following table.

#### Frequency band and maximum transmission output

Frequency band	Maximum transmission output
Short wave 3 - 54 MHz	100 W
4 m frequency band 74 - 88 MHz	30 W
2 m frequency band 144 - 174 MHz	50 W
Terrestrial Trunked Radio (TETRA) 380 - 460 MHz	10 W
70 cm frequency band 420 - 450 MHz	35 W
Two-way radio (2G/3G/4G)	10 W

The following can be used in the vehicle without restrictions:

- two-way radios with a maximum transmission output of up to 100 mW
- RF transmitters with transmitter frequencies in the 380 - 410 MHz frequency band and a maximum transmission output of up to 2 W (trunked radio system/Tetra)
- mobile phones (2G/3G/4G)

There are no restrictions when positioning the antenna on the outside of the vehicle for some wavebands.

- Terrestrial Trunked Radio (TETRA)
- 70 cm frequency band
- 2G/3G/4G

### Radio equipment approvals for the vehicle components

Manufacturer information about radio-based vehicle components can be found using the key word "Radio operating permits", in the Digital

Operator's Manual in the vehicle, on the Internet and in the app.

### Vehicle identification plate, VIN and engine number overview

#### Vehicle identification plate

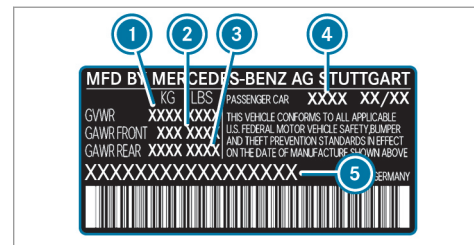
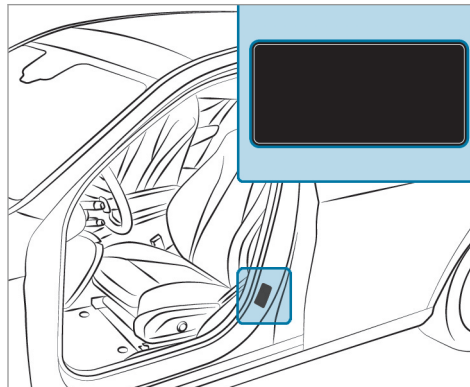

Vehicle identification plate (USA only)

- 1 Maximum permissible gross vehicle weight
- 2 Maximum permissible front axle load
- 3 Maximum permissible rear axle load
- 4 Paint code
- 5 VIN (vehicle identification number)

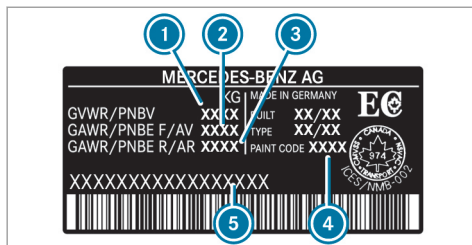

Vehicle identification plate (Canada only)

- ① Maximum permissible gross vehicle weight
- ② Maximum permissible front axle load
- ③ Maximum permissible rear axle load
- ④ Paint code
- ⑤ VIN (vehicle identification number)

The maximum permissible gross vehicle weight is made up of the vehicle weight, all vehicle occupants, the fuel and the load. The maximum gross axle weight rating is the maximum weight that can be carried on one axle (front or rear axle).

Do not exceed the maximum permissible gross vehicle weight or the maximum gross axle weight rating for the front or rear axle.

#### VIN in front of the front seat

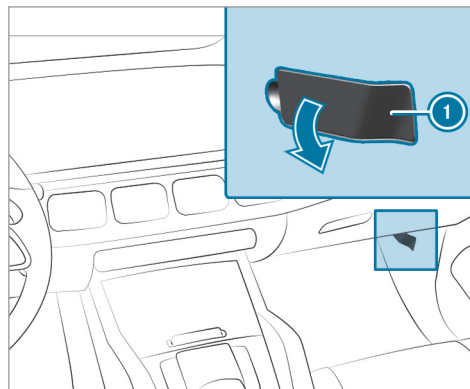

- ① VIN (vehicle identification number)

#### Additional plates

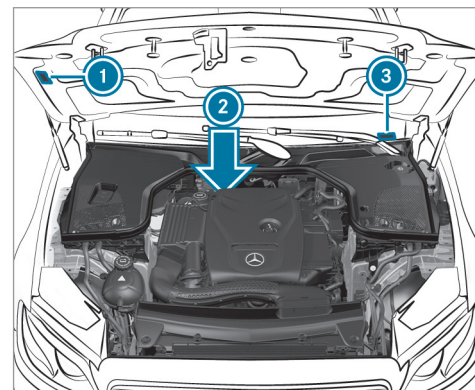

- ① Plate with information about emissions testing, including confirmation of emissions guidelines at the U.S. federal level as well as for California
- ② Engine number stamped into the crankcase
- ③ VIN (vehicle identification number) as a label at the lower edge of the windshield



## Operating fluids

### Notes on operating fluids

**Mercedes-AMG vehicles:** be sure to observe the notes in the Supplement. You could otherwise fail to recognize dangers.

**⚠ WARNING** Risk of injury from operating fluids harmful to your health

Operating fluids may be poisonous and harmful to your health.

- ▶ Observe the text on the original containers when using, storing or disposing of operating fluids.
- ▶ Always store operating fluids sealed in their original containers.
- ▶ Always keep children away from operating fluids.



**ENVIRONMENTAL NOTE** Environmental pollution caused by environmentally irresponsible disposal

- ▶ Dispose of operating fluids in an environmentally responsible manner.

Operating fluids include the following:

- Fuels
- Lubricants
- Coolant
- Brake fluid
- Windshield washer fluid
- Climate control system refrigerant

Only use products approved by Mercedes-Benz. Damage caused by the use of products that have not been approved is not covered by the Mercedes-Benz warranty or goodwill gestures.

You can identify operating fluids approved by Mercedes-Benz by the following inscriptions on the container:

- MB-Freigabe (e.g. MB-Freigabe 229.51)

- MB-Approval (e.g. MB-Approval 229.51)

Further information on approved operating fluids is available at the following locations:

- In the Mercedes-Benz Specifications for Operating Fluids by entering the designation
  - At <https://bevo.mercedes-benz.com>
  - In the Mercedes-Benz BeVo app
- At a qualified specialist workshop

**⚠ WARNING** Risk of fire or explosion from fuel

Fuels are highly flammable.

- ▶ Fire, open flames, smoking and creation of sparks must be avoided.
- ▶ Switch off the ignition and, if available, the stationary heater, before and while refueling the vehicle.

**⚠ WARNING** Risk of injury from fuels

Fuels are poisonous and hazardous to your health.

- ▶ Do not swallow fuel or let it come into contact with skin, eyes or clothing.
- ▶ Do not inhale fuel vapor.
- ▶ Keep children away from fuel.
- ▶ Keep doors and windows closed during the refueling process.

If you or other people come into contact with fuel, observe the following:

- ▶ Immediately rinse fuel off your skin with soap and water.
- ▶ If fuel comes into contact with your eyes, immediately rinse them thoroughly with clean water. Seek medical attention immediately.
- ▶ If you swallow fuel, seek medical attention immediately. Do not induce vomiting.
- ▶ Change immediately out of clothing that has come into contact with fuel.

## Fuel

### Notes on fuel grades for vehicles with a gasoline engine

Observe the notes on operating fluids (→ page 357).

#### **!** NOTE Damage caused by the wrong fuel

Even small amounts of the wrong fuel could result in damage to the fuel system, the engine and the emission control system.

- ▶ Only refuel with low-sulfur unleaded fuel.

This fuel may contain up to 10% ethanol by volume. Your vehicle is suitable for use with E10 fuel.

Never refuel with one of the following fuels:

- Diesel
- Gasoline with more than 10% ethanol by volume, e.g. E15, E85, E100
- Gasoline with more than 3% methanol by volume, e.g. M15, M30, M85, M100

- Gasoline with additives containing metal

If you have accidentally refueled with the wrong fuel:

- ▶ Do not switch the ignition on.
- ▶ Consult a qualified specialist workshop.

If the available fuel is not sufficiently low in sulfur, this can produce unpleasant odors.

Only refuel with fuel that has at least the octane number specified in the information label in the fuel filler flap (→ page 164). Otherwise, engine output can be reduced and fuel consumption increased.

**If you want maximum engine output:** only refuel with unleaded premium grade gasoline with an octane number of at least 91 AKI/95 RON.

As a temporary measure, if the recommended fuel is not available, you may also refuel with unleaded regular gasoline with at least 87 AKI/91 RON. This may reduce engine output and increase fuel consumption.

Never refuel using gasoline with an even lower RON.

**!** **NOTE** Premature wear through unleaded regular gasoline

Unleaded regular gasoline can cause the engine to wear more quickly and impair longevity and performance.

If unleaded premium grade gasoline is unavailable and you have to refuel using unleaded regular gasoline:

- ▶ Only fill the fuel tank to half full with unleaded regular gasoline and refill as soon as possible with unleaded premium grade gasoline.
- ▶ Do not drive at the maximum design speed.
- ▶ Avoid sudden acceleration engine speeds over 3000 rpm.

Further information on fuel is available at the following locations:

- at a gas station

- at a qualified specialist workshop
- on the <https://www.mbusa.com> (USA only)

**Information on additives in gasoline**

Observe the notes on operating fluids (→ page 357).

**!** **NOTE** Damage from use of unsuitable additives

Even small amounts of the wrong additive may lead to malfunctions occurring.

- ▶ Only add cleaning additives recommended by Mercedes-Benz to the fuel.

Mercedes-Benz recommends that you use fuel brands that have additives.

In some countries, the fuel available may not have sufficient additives. Residue could build up in the fuel injection system as a result. In this case, in consultation with an authorized Mercedes-Benz Center, the fuel may be mixed with the cleaning additive recommended by Mercedes-Benz. Be sure to observe the notes and mixing ratios specified on the container.

**Tank content and fuel reserve**

The total capacity of the fuel tank may vary, depending on the vehicle equipment.

Missing values were not available at the time of going to press.

**Capacity**

Model	Total capacity
All models	
Model	of which reserve fuel
All models	

**Engine oil**

**Notes on engine oil**

Observe the notes on operating fluids (→ page 357).



**!** **NOTE** Engine damage caused by an incorrect oil filter, incorrect oil or additives

- ▶ Do not use engine oils or oil filters other than those which meet the specifications necessary for the prescribed service intervals.
- ▶ Do not alter the engine oil or oil filter in order to achieve longer change intervals than prescribed.
- ▶ Do not use additives.
- ▶ Have the engine oil changed after the prescribed intervals.

Mercedes-Benz recommends that you have the oil change carried out at a qualified specialist workshop.

#### Quality and capacity of engine oil

Missing values were not available at the time of going to press.

#### MB-Freigabe or MB-Approval

Gasoline engines	Engine oil specifications
All models	

The following values refer to an oil change, including the oil filter.

Missing values were not available at the time of going to press.

#### Capacity

Model	Capacity
All models	

#### Notes on brake fluid

Observe the notes on operating fluids (→ page 357).

**!** **WARNING** Risk of an accident due to vapor pockets forming in the brake system

The brake fluid constantly absorbs moisture from the air. This lowers the boiling point of the brake fluid. If the boiling point is too low, vapor pockets may form in the brake system when the brakes are applied hard.

This causes the braking effect to be impaired.

- ▶ Have the brake fluid renewed at the specified intervals.

Have the brake fluid regularly replaced at a qualified specialist workshop. Only use a brake fluid approved by Mercedes-Benz according to MB-Freigabe or MB-Approval 331.0.

## Coolant

### Notes on coolant

Observe the notes on operating fluids (→ page 357).

**⚠ WARNING** - Risk of fire and injury from antifreeze

If antifreeze comes into contact with hot component parts in the engine compartment, it may ignite.

- ▶ Allow the engine to cool down before adding antifreeze.
- ▶ Make sure that no antifreeze spills out next to the filler opening.
- ▶ Thoroughly clean off any antifreeze from component parts before starting the vehicle.

**!** **NOTE** Damage caused by incorrect coolant

- ▶ Only add coolant that has been pre-mixed with the required antifreeze protection.

Information on coolant is available at the following locations:

- In the Mercedes-Benz Specifications for Operating Fluids 310.1:
  - At <https://bevo.mercedes-benz.com>
  - In the Mercedes-Benz BeVo app
- At a qualified specialist workshop

**!** **NOTE** Overheating at high outside temperatures

If an inappropriate coolant is used, the engine cooling system is not sufficiently protected against overheating and corrosion at high outside temperatures.

- ▶ Always use coolant approved by Mercedes-Benz.

- ▶ Observe the instructions in the Mercedes-Benz Specifications for Operating Fluids 310.1.

Have the coolant regularly replaced at a qualified specialist workshop.

The proportion of corrosion inhibitor/antifreeze concentrate in the engine cooling system should be:

- A minimum of 50% (antifreeze protection down to approximately -35 °F (-37 °C))
- A maximum of 55% (antifreeze protection down to -49 °F (-45 °C))

### Coolant capacity

Missing values were not available at the time of going to press.

Model	Capacity
All models	

### Notes on windshield washer fluid

Observe the notes on operating fluids (→ page 357).

**⚠ WARNING** - Risk of fire and injury from windshield washer concentrate

Windshield washer concentrate is highly flammable. It could ignite if it comes into contact with hot engine component parts or the exhaust system.

- ▶ Make sure that no windshield washer concentrate spills out next to the filler opening.

**! NOTE** Damage to the exterior lighting due to unsuitable windshield washer fluid

Unsuitable windshield washer fluid may damage the plastic surface of the exterior lighting.

- ▶ Only use windshield washer fluid which is also suitable for use on plastic surfaces, e.g. MB SummerFit or MB WinterFit.

**! NOTE** Blocked spray nozzles caused by mixing windshield washer fluids

- ▶ Do not mix MB SummerFit and MB WinterFit with other windshield washer fluids.

Do not use distilled or de-ionized water as the fill level sensor may be triggered erroneously.

Recommended windshield washer fluid:

- Above freezing point: e.g. MB SummerFit
- Below freezing point: e.g. MB WinterFit

For the correct mixing ratio, refer to the information on the antifreeze container.

Mix the washer fluid with the windshield washer fluid all year round.

### Refrigerant

#### Notes on refrigerant

Observe the notes on operating fluids (→ page 357).

**! NOTE** Damage due to incorrect refrigerant

If a non-approved refrigerant is used, the climate control system may be damaged.

- ▶ **USA/China:** Use only R-134a refrigerant.
- ▶ **Canada:** Use only R-1234yf refrigerant.

**! NOTE** Damage to the climate control system due to incorrect refrigerant compressor oil

- ▶ Only use refrigerant compressor oil that has been approved by Mercedes-Benz.
- ▶ Do not mix the approved refrigerant compressor oil with a different refrigerant compressor oil.

Work on the climate control system may be carried out only by a qualified specialist workshop. All applicable regulations, as well as SAE standard J639, must be adhered to.

The information label on the climate control system for the refrigerant type and the refrigerant

compressor oil is located on the inside of the hood.

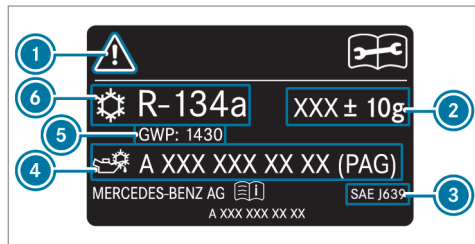

Information label (example – USA/China)

- ① Hazard and service warning symbols
- ② Refrigerant filling capacity
- ③ Applicable standards
- ④ PAG oil part number
- ⑤ GWP (Global Warming Potential) of the refrigerant used
- ⑥ Refrigerant type

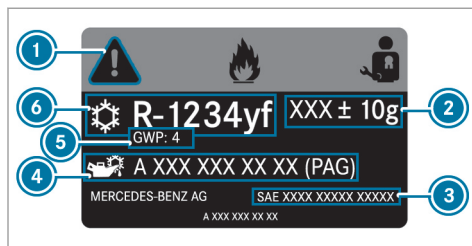

Information label (example – Canada)

- ① Hazard and service warning symbols
- ② Refrigerant filling capacity
- ③ Applicable standards
- ④ PAG oil part number
- ⑤ GWP (Global Warming Potential) of the refrigerant used
- ⑥ Refrigerant type

Symbols ① indicate the following:

- Possible dangers
- The need to have service work carried out at a qualified specialist workshop only

## Refrigerant filling capacity

### Filling capacity for refrigerant and PAG oil

Model	Refrigerant
All models	
Model	PAG oil
All models	

## Vehicle data

### Vehicle dimensions

The heights specified may vary as a result of the:

- Tires
- Load
- Condition of the suspension
- Optional equipment

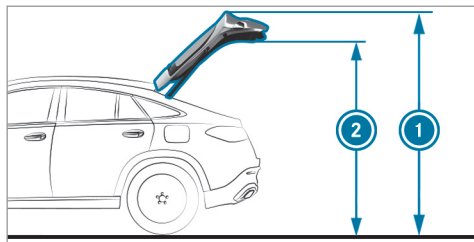

Missing values were not available at the time of going to press.

#### Height when opened

	① Height when opened*	② Head- room*
<b>Vehicles with steel suspension</b>	90.8 in (2307 mm)	77.6 in (1971 mm)
<b>Vehicles with AIR-MATIC</b>	89.2 in (2266 mm) - 92.1 in (2341 mm)	76.0 in (1931 mm) - 78.9 in (2006 mm)

\*When the rear-end lowering is activated, the values are correspondingly lower.

#### Vehicle dimensions

All models	
Vehicle length	
Vehicle width including outside mirrors	84.9 in (2157 mm)
Vehicle width excluding outside mirrors, min. to max.	79.1 in (2010 mm) - 79.4 in (2018 mm)
Vehicle height (steel suspension)	68.1 in (1730 mm)
Maximum vehicle height (AIR-MATIC)	69.5 in (1766 mm)
Wheelbase	115.5 in (2935 mm)
Maximum ground clearance (steel suspension)	8.1 in (206 mm)

#### All models

Maximum ground clearance (AIR-MATIC)	9.8 in (249 mm)
Minimum ground clearance (AIR-MATIC)	6.8 in (174 mm)

#### Weights and loads

Please note that for the specified vehicle data:

- Items of optional equipment increase the curb weight and reduce the payload.

#### Roof load

All models	
Maximum roof load	165.4 lb (75 kg)

#### Maximum design speeds

The following values only apply to vehicles with the AMG Driver's Package.



**Maximum design speeds**

Mercedes-AMG GLE 63 S 4MATIC+	
1st gear	33 mph (54 km/h)
2nd gear	55 mph (90 km/h)
3rd gear	80 mph (129 km/h)
4th gear	111 mph (178 km/h)
5th gear	149 mph (240 km/h)
6th gear	155 mph (250 km/h)
7th gear	155 mph (250 km/h)
8th gear	174 mph (280 km/h)
9th gear	174 mph (280 km/h)

**Off-road driving vehicle data**
**Forcing depth**

**!** **NOTE** Damage caused by water when fording

Water can enter the engine compartment and vehicle interior in the following cases:

- The maximum permissible fording depth when driving through standing water is exceeded
- A bow wave forms during fording
- Water accumulates during fording of flowing water

▶ Do not exceed the maximum permissible fording depth and drive slowly through the water.

The specified value indicates the maximum permissible fording depth for vehicles that are ready to drive and for slow driving through standing water.

Driving through flowing water reduces the permissible fording depth due to the accumulation of water.

Observe the notes on off-road driving and fording (→ page 151).

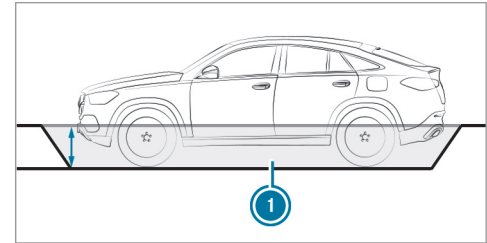

Model	<b>1</b> Fording depth
<b>Vehicles with steel suspension</b>	19.7 in (50 cm)
<b>Vehicles with AIRMATIC</b>	
Raised level	19.7 in (50 cm)

**Approach/departure angle**

The specified values are maximum values for vehicles that are ready to drive.

Observe the notes on driving in mountainous terrain (→ page 151).

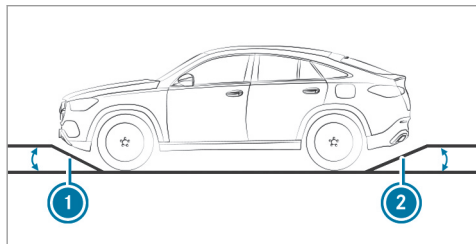

All models	1 Front	2 Rear
Vehicles with steel suspension*	21°	22°
Vehicles with AIRMATIC*		

All models	1 Front	2 Rear
Normal level	21°	21°
Raised level	24°	24°

\* Depending on the tire size

**Maximum gradient climbing ability**

The vehicle's gradient climbing ability depends on the weight distribution in the vehicle, the terrain conditions and the road surface conditions.

The specified value applies in the following cases:

- The vehicle is ready to drive
- The road surface conditions and thus traction are good

A gradient climbing ability of 100% corresponds to an incline of 45°.

Observe the notes on driving in mountainous terrain (→ page 151).

Model	Maximum gradient climbing ability
All models	80%

**Trailer hitch****General notes on the trailer hitch**

Modifications to the engine cooling system may be necessary, depending on the vehicle model. The retrofitting of a trailer hitch is only permissible if a towing capacity is specified in your vehicle documents.

Further information can be obtained at a qualified specialist workshop.

**Permissible trailer load**

The tongue weight is not included in the towing capacity.

### Towing capacity

Model	Permissible towing capacity, braked
All models	7716 lbs (3500 kg)

### Maximum tongue weight

**!** **NOTE** Damage caused by the trailer coming loose

If the tongue weight used is too low, the trailer may come loose.

- ▶ The tongue weight must not be below 110.2 lb (50 kg).
- ▶ Use a tongue weight that is as close as possible to the maximum permissible tongue weight.

### Tongue weight

Model	Maximum tongue weight
All models	617 lbs (280 kg)

### Permissible rear axle load (trailer operation)

Missing values were not available at the time of going to press.

### Axle load

	Permissible rear axle load during trailer operation
All models	

## Display messages

### Introduction



#### Notes about display messages

Display messages appear on the multifunction display.

Display messages with graphic symbols are simplified in the Operator's Manual and may differ from the symbols on the multifunction display. The multifunction display shows high-priority display messages in red. Certain display messages are accompanied by a warning tone.

Please act in accordance with the display messages and follow the additional notes in the Operator's Manual.

For some display messages, a symbol will also be shown:

-  Further information
-  Hide display message

With the left-hand Touch Control, you can select the respective symbol by swiping to the left or right. Press the  symbol to show further infor-

mation on the multifunction display. Press the  symbol to hide the display message.

You can hide low-priority display messages by pressing the  button or the left-hand Touch Control. The display messages will then be stored in the message memory.

Rectify the cause of a display message as quickly as possible.

High-priority display messages cannot be hidden. The multifunction display shows these display messages continuously until the cause of the display message has been rectified.



#### Calling up saved display messages

On-board computer:



 [Service](#)  [1 Message](#)

If there are no display messages, [No Messages](#) will appear on the multifunction display.

 Scroll through the display messages by swiping upwards or downwards on the left-hand Touch Control.







 **To exit the message memory:** press the  button.

## Occupant safety

Display messages	Possible causes/consequences and ► Solutions
 <p data-bbox="195 384 445 433">SRS Malfunction Service Required</p>	<p data-bbox="524 291 1068 317">* The restraint system is malfunctioning (→ page 37).</p> <div data-bbox="547 332 1698 451" style="border: 1px solid gray; padding: 5px;"> <p data-bbox="565 342 1286 368">▲ <b>WARNING</b> Risk of injury due to malfunctions in the restraint system</p> <p data-bbox="565 381 1655 407">Components in the restraint system may be activated unintentionally or not deploy as planned in an accident.</p> <p data-bbox="565 417 1548 443">► Have the restraint system checked and repaired immediately at a qualified specialist workshop.</p> </div>
 <p data-bbox="195 563 473 612">Front Left Malfunction Service Required (example)</p>	<p data-bbox="524 470 1215 496">* The corresponding restraint system is malfunctioning (→ page 37).</p> <div data-bbox="547 511 1698 630" style="border: 1px solid gray; padding: 5px;"> <p data-bbox="565 522 1286 548">▲ <b>WARNING</b> Risk of injury due to malfunctions in the restraint system</p> <p data-bbox="565 560 1655 586">Components in the restraint system may be activated unintentionally or not deploy as planned in an accident.</p> <p data-bbox="565 596 1548 622">► Have the restraint system checked and repaired immediately at a qualified specialist workshop.</p> </div>
 <p data-bbox="195 742 436 814">Left Side Curtain Airbag Malfunction Service Required (example)</p>	<p data-bbox="524 649 1276 675">* The corresponding window curtain airbag is malfunctioning (→ page 37).</p> <div data-bbox="547 691 1698 833" style="border: 1px solid gray; padding: 5px;"> <p data-bbox="565 701 1493 727">▲ <b>WARNING</b> Risk of injury or fatal injury due to a malfunction in the window curtain airbag</p> <p data-bbox="565 739 1655 786">The window curtain airbag might be triggered unintentionally or might not be triggered at all in the event of an accident.</p> <p data-bbox="565 796 1609 822">► Have the window curtain airbag checked and repaired immediately at a qualified specialist workshop.</p> </div>

## 370 Display messages and warning/indicator lamps

Display messages	Possible causes/consequences and ► Solutions
<p>Front Passenger Airbag Disabled See Operator's Manual</p>	<p>* The front passenger airbag has been disabled even though an adult or a person of adult stature is on the front passenger seat. If additional forces are applied to the seat, the weight the system detects may be too low.</p> <div data-bbox="495 319 1648 524" style="border: 1px solid gray; padding: 5px;"><p><b>▲ WARNING</b> Risk of injury or fatal injury due to a disabled front passenger airbag</p><p>If the front passenger airbag is disabled, the front passenger airbag will not be deployed in the event of an accident and cannot perform its intended protective function.</p><p>A person in the front passenger seat could then, for example, come into contact with the vehicle's interior, especially if the person is sitting too close to the cockpit.</p><p>► Make sure, both before and during the journey, that the status of the front passenger airbag is correct.</p></div> <p>► Stop the vehicle immediately in accordance with the traffic conditions.</p> <p>► Check the status of the automatic front passenger airbag actuation (→ page 46).</p> <p>► If necessary, consult a qualified specialist workshop immediately.</p>
<p>Front Passenger Airbag Enabled See Operator's Manual</p>	<p>* The front passenger airbag is enabled while the vehicle is in motion:</p> <ul style="list-style-type: none"><li>• even when a child, a person of smaller stature or an object weighing less than the system weight threshold is located on the front passenger seat</li><li>• even when the front passenger seat is not occupied</li></ul> <p>The system may detect objects or forces that are adding to the weight applied to the seat.</p>

Display messages	Possible causes/consequences and ► Solutions
	<p data-bbox="563 256 1681 308">  <b>WARNING</b> Risk of injury or fatal injury when using a child restraint system while the front passenger airbag is enabled                 </p> <p data-bbox="563 324 1644 376">                     If you secure a child in a child restraint system on the front passenger seat and the front passenger airbag is enabled, the front passenger airbag may deploy in the event of an accident.                 </p> <p data-bbox="563 386 951 412">                     The child could be struck by the airbag.                 </p> <p data-bbox="563 422 1580 448">  Both before and during the journey, ensure that the status of the front passenger airbag is correct.                 </p> <p data-bbox="563 464 1653 515">                     NEVER use a child restraint system facing to the rear on a seat with an ACTIVATED FRONT AIRBAG. DEATH or SERIOUS INJURY to the child can occur.                 </p> <p data-bbox="545 541 1395 635">  Stop the vehicle immediately in accordance with the traffic conditions.   Check the status of the automatic front passenger airbag actuation (→ page 46).   If necessary, consult a qualified specialist workshop immediately.                 </p>
PRE-SAFE Inoperative See Operator's Manual	<p data-bbox="517 655 997 681">* The PRE-SAFE® functions are malfunctioning.</p> <p data-bbox="545 686 979 712">  Consult a qualified specialist workshop.                 </p>
PRE-SAFE Impulse Side Inoperative See Operator's Manual	<p data-bbox="517 733 1598 759">* The PRE-SAFE® Impulse Side system is malfunctioning or inoperative after having already been triggered.</p> <p data-bbox="545 764 979 790">  Consult a qualified specialist workshop.                 </p>

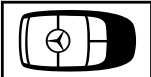
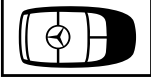
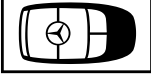

### SmartKey



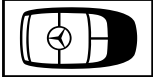
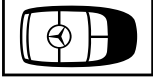

Display messages	Possible causes/consequences and ► Solutions
 <p data-bbox="144 381 325 407">Obtain a New Key</p>	<ul style="list-style-type: none"> <li data-bbox="469 291 857 317">* The SmartKey needs to be replaced.</li> <li data-bbox="495 322 925 348">► Consult a qualified specialist workshop.</li> </ul>
 <p data-bbox="144 526 347 552">Replace Key Battery</p>	<ul style="list-style-type: none"> <li data-bbox="469 436 857 462">* The SmartKey battery is discharged.</li> <li data-bbox="495 467 864 493">► Replace the battery (→ page 67).</li> </ul>
 <p data-bbox="144 671 393 717">Key Not Detected (white display message)</p>	<ul style="list-style-type: none"> <li data-bbox="469 581 875 607">* The SmartKey is currently undetected.</li> <li data-bbox="495 612 1042 638">► Change the location of the SmartKey in the vehicle.</li> <li data-bbox="495 643 1504 689">► If the SmartKey is still not recognized, place it in the marked space for starting with the SmartKey (→ page 144).</li> </ul>



Display messages	Possible causes/consequences and ► Solutions
 <p data-bbox="195 344 463 394">Key Not Detected (red display message)</p>	<p data-bbox="524 249 1252 273">* The SmartKey cannot be detected and may no longer be in the vehicle.</p> <p data-bbox="543 283 1252 307">The SmartKey is no longer in the vehicle and you switch off the engine:</p> <ul data-bbox="543 318 953 377" style="list-style-type: none"> <li data-bbox="543 318 931 341">• You can no longer start the engine.</li> <li data-bbox="543 352 953 377">• You cannot centrally lock the vehicle.</li> </ul> <p data-bbox="543 394 1005 418">► Ensure that the SmartKey is in the vehicle.</p> <p data-bbox="543 446 1434 470">If the SmartKey detection function has a malfunction due to a strong radio signal source:</p> <ul data-bbox="543 480 1559 539" style="list-style-type: none"> <li data-bbox="543 480 1286 504">► Stop the vehicle immediately in accordance with the traffic conditions.</li> <li data-bbox="543 514 1559 539">► Place the SmartKey in the marked space for starting the engine with the SmartKey (→ page 144).</li> </ul>
<p data-bbox="195 557 463 629">Place the Key in the Marked Space See Operator's Manual</p>	<p data-bbox="524 557 925 581">* SmartKey detection is malfunctioning.</p> <ul data-bbox="543 591 1559 650" style="list-style-type: none"> <li data-bbox="543 591 1092 615">► Change the location of the SmartKey in the vehicle.</li> <li data-bbox="543 625 1559 650">► Place the SmartKey in the marked space for starting the engine with the SmartKey (→ page 144).</li> </ul>
 <p data-bbox="195 759 421 783">Don't Forget Your Key</p>	<p data-bbox="524 666 1646 713">* A warning tone will also sound. This message reminds you to take your SmartKey with you when you leave the vehicle.</p>

## Lights

Display messages	Possible causes/consequences and ► Solutions
 <p>Check Left Low Beam (example)</p>	<ul style="list-style-type: none"> <li>* The corresponding light source is faulty.                             <ul style="list-style-type: none"> <li>► Drive on carefully.</li> <li>► Consult a qualified specialist workshop immediately.</li> </ul> </li> <li>ⓘ LED light sources: the display message for the corresponding light appears only when all the light-emitting diodes in the light are faulty.</li> </ul>
 <p>Malfunction See Operator's Manual</p>	<ul style="list-style-type: none"> <li>* The exterior lighting is malfunctioning.                             <ul style="list-style-type: none"> <li>► Consult a qualified specialist workshop.</li> </ul> </li> </ul>
 <p>Automatic Headlamp Mode Inoperative</p>	<ul style="list-style-type: none"> <li>* The light sensor is malfunctioning.                             <ul style="list-style-type: none"> <li>► Consult a qualified specialist workshop.</li> </ul> </li> </ul>



Display messages	Possible causes/consequences and ► Solutions
 <p data-bbox="195 344 469 391">Active Headlamps Inoperative</p>	<ul style="list-style-type: none"> <li>* The active headlamps are malfunctioning.           <ul style="list-style-type: none"> <li>► Consult a qualified specialist workshop.</li> </ul> </li> </ul>
 <p data-bbox="195 515 421 536">Switch On Headlamps</p>	<ul style="list-style-type: none"> <li>* You are driving without low-beam headlamps.           <ul style="list-style-type: none"> <li>► Turn the light switch to the  or <b>AUTO</b> position.</li> </ul> </li> </ul>
 <p data-bbox="195 655 371 676">Switch Off Lights</p>	<ul style="list-style-type: none"> <li>* You are leaving the vehicle and the lights are still switched on.           <ul style="list-style-type: none"> <li>► Turn the light switch to the <b>AUTO</b> position.</li> </ul> </li> </ul>
 <p data-bbox="195 795 469 842">Intell. Light System Inoperative</p>	<ul style="list-style-type: none"> <li>* The Intelligent Light System is malfunctioning. The lighting system continues to function properly without the functions of the Intelligent Light System.           <ul style="list-style-type: none"> <li>► Consult a qualified specialist workshop.</li> </ul> </li> </ul>

## 376 Display messages and warning/indicator lamps

Display messages	Possible causes/consequences and ► Solutions
<a href="#">Adaptive Highbeam Assist Currently Unavailable See Operator's Manual</a>	<ul style="list-style-type: none"><li>* Adaptive Highbeam Assist is temporarily unavailable. The system limits have been reached (→ page 124).<ul style="list-style-type: none"><li>► Drive on. Once the cause of the problem is no longer present, the system will be available again. The <a href="#">Adaptive Highbeam Assist Now Available</a> display message will appear.</li></ul></li></ul>
<a href="#">Adaptive Highbeam Assist Inoperative</a>	<ul style="list-style-type: none"><li>* Adaptive Highbeam Assist is malfunctioning.<ul style="list-style-type: none"><li>► Consult a qualified specialist workshop.</li></ul></li></ul>
<a href="#">Hazard Warning Flashers Malfunctioning</a>	<ul style="list-style-type: none"><li>* The hazard warning lamp switch is malfunctioning.<ul style="list-style-type: none"><li>► Consult a qualified specialist workshop.</li></ul></li></ul>

## Vehicle

Display messages	Possible causes/consequences and ► Solutions
<a href="#">Update Successfully Completed</a>	<ul style="list-style-type: none"><li>* Installation of the software update has been successfully completed (→ page 257).</li></ul>
<a href="#">Update Failed Software Remains Unchanged</a>	<ul style="list-style-type: none"><li>* An error occurred during installation of the software update (→ page 257). The previous software version remains in place.</li></ul>
<a href="#">Update Failed</a>	<ul style="list-style-type: none"><li>* An error occurred during installation of the software update (→ page 257).</li></ul>

Display messages	Possible causes/consequences and ► Solutions
 <p>Vehicle Ready to Drive Switch the Ignition Off Before Exiting</p>	<p>Make a Mercedes me call via the overhead control panel (→ page 271).</p> <p>* You are leaving the vehicle when it is in a ready-to-drive state.</p> <ul style="list-style-type: none"> <li>► When you leave the vehicle, switch off the ignition, secure the vehicle against rolling away and take the Smart-Key with you.</li> <li>► If you do not leave the vehicle, switch off the electrical consumers, e.g. the seat heating. Otherwise, the 12 V battery may discharge and it will then be possible to start the vehicle only with the aid of a second battery (starting assistance).</li> </ul>
 <p>Steering Malfunction Increased Physical Effort See Operator's Manual</p>	<p>* The power steering assistance is malfunctioning.</p> <div style="background-color: #f0f0f0; padding: 5px; border: 1px solid #ccc;"> <p><b>⚠ WARNING</b> Risk of an accident due to altered steering characteristics</p> <p>If the power assistance of the steering fails partially or completely, you will need to use more force to steer.</p> <ul style="list-style-type: none"> <li>► If safe steering is possible, drive on carefully.</li> <li>► Visit or consult a qualified specialist workshop immediately.</li> </ul> </div>
 <p>Steering Malfunction Stop Immediately See Operator's Manual</p>	<p>* The steering is malfunctioning. Steering capability is significantly impaired.</p> <div style="background-color: #f0f0f0; padding: 5px; border: 1px solid #ccc;"> <p><b>⚠ WARNING</b> Risk of accident if steering capability is impaired</p> <p>If the steering does not function as intended, the vehicle's operating safety is jeopardized.</p> </div>

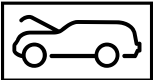
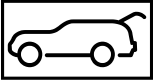

### 378 Display messages and warning/indicator lamps

Display messages	Possible causes/consequences and ► Solutions
	<ul style="list-style-type: none"><li>► Pull over and stop the vehicle safely as soon as possible, paying attention to road and traffic conditions. Do not continue driving under any circumstances.</li><li>► Consult a qualified specialist workshop.</li></ul>
	<p>* At least one door is open.</p> <ul style="list-style-type: none"><li>► Close all doors.</li></ul>
	<p>* The hood is open.</p> <p><b>▲ WARNING</b> Risk of accident due to driving with the hood unlocked</p> <p>The hood may open and block your view.</p> <ul style="list-style-type: none"><li>► Never release the hood when driving.</li><li>► Before every trip, ensure that the hood is locked.</li></ul> <ul style="list-style-type: none"><li>► Stop the vehicle immediately, paying attention to road and traffic conditions.</li><li>► Close the hood.</li></ul>
	<p>* The tailgate is open.</p>



Display messages	Possible causes/consequences and ► Solutions
	<p><b>▲ DANGER</b> Risk of exhaust gas poisoning</p> <p>Combustion engines emit poisonous exhaust gases such as carbon monoxide. Exhaust gases can enter the vehicle interior if the tailgate is open when the engine is running, especially if the vehicle is in motion.</p> <ul style="list-style-type: none"> <li>▶ Always switch off the engine before opening the tailgate.</li> <li>▶ Never drive with the tailgate open.</li> </ul> <p>► Close the tailgate.</p>
 <p>Check Washer Fluid</p>	<p>* The washer fluid level in the washer fluid reservoir has dropped below the minimum.</p> <p>► Add washer fluid (→ page 294).</p>

## Engine

Display messages	Possible causes/consequences and ► Solutions
<p>To switch engine off, press and hold Start/Stop button for at least 3 seconds or press 3 times.</p>	<p>* You have pressed the start/stop button while the vehicle is in motion.</p> <p>► Information about switching off the engine while driving (→ page 144).</p>

Display messages	Possible causes/consequences and ► Solutions
 <p data-bbox="144 342 399 391">Check Coolant Level See Operator's Manual</p>	<p data-bbox="476 249 772 270">* The coolant level is too low.</p> <div data-bbox="500 291 1646 379"><p data-bbox="513 301 1042 325"><b>!</b> <b>NOTE</b> Engine damage due to insufficient coolant</p><p data-bbox="513 342 994 366">► Avoid long journeys with insufficient coolant.</p></div> <ul data-bbox="495 394 1282 453" style="list-style-type: none"><li data-bbox="495 394 802 418">► Add coolant (→ page 293).</li><li data-bbox="495 428 1282 453">► Have the engine cooling system checked at a qualified specialist workshop.</li></ul>
 <p data-bbox="144 563 421 612">Coolant Too Hot Stop Vehicle Turn Engine Off</p>	<p data-bbox="476 470 717 491">* The coolant is too hot.</p> <ul data-bbox="495 501 1622 529" style="list-style-type: none"><li data-bbox="495 501 1622 529">► Pull over and stop the vehicle safely and switch off the engine, paying attention to road and traffic conditions.</li></ul> <div data-bbox="500 553 1646 733"><p data-bbox="513 563 1068 587"><b>!</b> <b>WARNING</b> Danger of burns when opening the hood</p><p data-bbox="513 605 1591 653">If you open the hood when the engine has overheated or during a fire in the engine compartment, you could come into contact with hot gases or other escaping operating fluids.</p><ul data-bbox="513 667 1498 723" style="list-style-type: none"><li data-bbox="513 667 1110 691">► Before opening the hood, allow the engine to cool down.</li><li data-bbox="513 701 1498 725">► In the event of a fire in the engine compartment, keep the hood closed and call the fire service.</li></ul></div> <ul data-bbox="495 750 1622 871" style="list-style-type: none"><li data-bbox="495 750 912 773">► Wait until the engine has cooled down.</li><li data-bbox="495 784 1153 808">► Make sure that the air supply to the radiator is not obstructed.</li><li data-bbox="495 818 1622 871">► Avoiding high loads on the engine, drive to the nearest qualified specialist workshop. In doing so, ensure that the coolant temperature display remains below the red marking.</li></ul>



Display messages	Possible causes/consequences and ► Solutions
	<ul style="list-style-type: none"> <li>* The fan motor is faulty.                             <ul style="list-style-type: none"> <li>► Avoiding high loads on the engine, drive to the nearest qualified specialist workshop. In doing so, ensure that the coolant temperature display remains below the red marking.</li> </ul> </li> </ul>
 <p data-bbox="195 449 347 472">Fuel Level Low</p>	<ul style="list-style-type: none"> <li>* The fuel supply has dropped into the reserve range.                             <ul style="list-style-type: none"> <li>► Refuel.</li> </ul> </li> </ul>
 <p data-bbox="195 589 347 612">Gas Cap Loose</p>	<ul style="list-style-type: none"> <li>* The fuel filler cap is not closed correctly or the fuel system is leaking.                             <ul style="list-style-type: none"> <li>► Close the fuel filler cap.</li> <li>► <b>If the fuel filler cap was already properly closed:</b> consult a qualified specialist workshop.</li> </ul> </li> </ul>

## Transmission

Display messages	Possible causes/consequences and ► Solutions
<p data-bbox="195 764 473 816">Only Shift to 'P' when Vehicle is Stationary</p>	<ul style="list-style-type: none"> <li>* Park position <b>P</b> can be engaged only when the vehicle is stationary.                             <ul style="list-style-type: none"> <li>► To stop, depress the brake pedal.</li> <li>► Shift the transmission to park position <b>P</b> while the vehicle is stationary.</li> </ul> </li> </ul>

## 382 Display messages and warning/indicator lamps

Display messages	Possible causes/consequences and ► Solutions
Apply Brake to Shift from 'P'	<ul style="list-style-type: none"><li>* You have attempted to shift the transmission out of park position <b>P</b> and into another transmission position.<ul style="list-style-type: none"><li>► Depress the brake pedal.</li><li>► Select transmission position <b>D</b>, <b>R</b> or neutral <b>N</b>.</li></ul></li></ul>
To Deselect P or N, Depress Brake and Start Engine	<ul style="list-style-type: none"><li>* You have attempted to shift the transmission out of park position <b>P</b> or neutral <b>N</b> and into another transmission position.<ul style="list-style-type: none"><li>► Depress the brake pedal.</li><li>► Change the transmission position.</li><li>► Start the engine.</li></ul></li></ul>
Apply Brake to Shift to D or R	<ul style="list-style-type: none"><li>* You have attempted to select transmission position <b>D</b> or <b>R</b>.<ul style="list-style-type: none"><li>► Depress the brake pedal.</li><li>► Select transmission position <b>D</b> or <b>R</b>.</li></ul></li></ul>
Apply Brake to Shift to 'R'	<ul style="list-style-type: none"><li>* You have attempted to select transmission position <b>R</b>.<ul style="list-style-type: none"><li>► Depress the brake pedal.</li><li>► Select transmission position <b>R</b>.</li></ul></li></ul>
Driver's Door Open & Transmission Not in P Risk of Vehicle Rolling Away	<ul style="list-style-type: none"><li>* The driver's door is not fully closed and transmission position <b>D</b>, <b>R</b> or neutral <b>N</b> is selected.<ul style="list-style-type: none"><li>► Select park position <b>P</b> when switching off the vehicle.</li></ul></li></ul>





Display messages	Possible causes/consequences and ► Solutions
<p>N Permanently Active Risk of Rolling Away</p>	<ul style="list-style-type: none"> <li>* While the vehicle is rolling or while you are driving, neutral <b>N</b> has been engaged.               <ul style="list-style-type: none"> <li>► To stop, depress the brake pedal.</li> <li>► Shift the transmission to park position <b>P</b> while the vehicle is stationary.</li> <li>► To continue driving, select transmission position <b>D</b> or <b>R</b>.</li> </ul> </li> </ul>
<p>Service Required Do Not Shift Gears Visit Dealer</p>	<ul style="list-style-type: none"> <li>* The transmission is malfunctioning. The transmission position can no longer be changed.               <ul style="list-style-type: none"> <li>► When transmission position <b>D</b> is selected, consult a qualified specialist workshop and do not change the transmission position.</li> <li>► For all other transmission positions, park the vehicle safely.</li> <li>► Consult a qualified specialist workshop or breakdown service.</li> </ul> </li> </ul>
<p>Reversing Not Possible Service Required</p>	<ul style="list-style-type: none"> <li>* The transmission is malfunctioning. The transmission position <b>R</b> cannot be selected.               <ul style="list-style-type: none"> <li>► Consult a qualified specialist workshop.</li> </ul> </li> </ul>
<p>Transmission Malfunction Stop</p>	<ul style="list-style-type: none"> <li>* The transmission is malfunctioning. The transmission shifts to neutral <b>N</b> automatically.               <ul style="list-style-type: none"> <li>► Stop the vehicle immediately in accordance with the traffic conditions.</li> <li>► Depress the brake pedal.</li> <li>► Engage park position <b>P</b>.</li> <li>► Consult a qualified specialist workshop.</li> </ul> </li> </ul>









### 384 Display messages and warning/indicator lamps

---





Display messages	Possible causes/consequences and ► Solutions
Stop Vehicle Leave Engine Running Wait Transmission Cooling	<ul style="list-style-type: none"><li>* The transmission is overheating. Pulling away may be temporarily impaired or not possible.<ul style="list-style-type: none"><li>► Stop the vehicle immediately in accordance with the traffic conditions. Do not continue driving.</li><li>► Leave the engine running.</li><li>► Wait until the display message disappears before pulling away.</li></ul></li></ul>
Auxiliary Battery Malfunction	<ul style="list-style-type: none"><li>* The auxiliary battery for the transmission is no longer being charged.<ul style="list-style-type: none"><li>► Consult a qualified specialist workshop.</li><li>► Until then, always select park position <b>P</b> manually before you switch off the engine.</li><li>► Before leaving the vehicle, apply the electric parking brake.</li></ul></li></ul>

## Brakes







Display messages	Possible causes/consequences and ► Solutions
<div data-bbox="205 294 362 376" data-label="Image"> </div> <p data-bbox="205 384 306 408">(USA only)</p> <div data-bbox="205 420 362 502" data-label="Image"> </div> <p data-bbox="205 510 340 534">(Canada only)</p> <p data-bbox="195 544 454 594">Parking Brake See Operator's Manual</p>	<p data-bbox="526 291 1360 314">* The yellow  indicator lamp is lit. The electric parking brake is malfunctioning.</p> <p data-bbox="545 325 643 349"><b>To apply:</b></p> <ul data-bbox="545 359 1147 418" style="list-style-type: none"> <li data-bbox="545 359 1027 383">► Switch the ignition off and switch it back on.</li> <li data-bbox="545 392 1147 418">► Apply the electric parking brake manually (→ page 172).</li> </ul> <p data-bbox="545 444 1082 468">If it is not possible to apply the electric parking brake:</p> <ul data-bbox="545 478 1276 537" style="list-style-type: none"> <li data-bbox="545 478 977 502">► Consult a qualified specialist workshop.</li> <li data-bbox="545 511 1276 537">► Where necessary, also secure the parked vehicle against rolling away.</li> </ul> <p data-bbox="526 548 1692 596">* The yellow  indicator lamp and the red  (USA only) or  (Canada only) indicator lamp are lit. The electric parking brake is malfunctioning.</p> <p data-bbox="545 607 661 630"><b>To release:</b></p> <ul data-bbox="545 641 1169 700" style="list-style-type: none"> <li data-bbox="545 641 1027 665">► Switch the ignition off and switch it back on.</li> <li data-bbox="545 674 1169 700">► Release the electric parking brake manually (→ page 172).</li> </ul> <p data-bbox="545 710 569 734">or</p> <ul data-bbox="545 744 1212 768" style="list-style-type: none"> <li data-bbox="545 744 1212 768">► Release the electric parking brake automatically (→ page 171).</li> </ul> <p data-bbox="545 772 1147 796">If it is still not possible to release the electric parking brake:</p> <ul data-bbox="545 807 1221 830" style="list-style-type: none"> <li data-bbox="545 807 1221 830">► Do not continue driving. Consult a qualified specialist workshop.</li> </ul>

Display messages	Possible causes/consequences and ► Solutions
	<p>* The yellow  indicator lamp is lit and the red  (USA only) or  (Canada only) indicator lamp is flashing. The electric parking brake is malfunctioning.</p> <p>The electric parking brake could not be applied or released.</p> <ul style="list-style-type: none"><li>► Switch the ignition off and switch it back on.</li></ul> <p><b>To apply:</b></p> <ul style="list-style-type: none"><li>► Release and then apply the electric parking brake manually (→ page 172).</li></ul> <p><b>To release:</b></p> <ul style="list-style-type: none"><li>► Apply and then release the electric parking brake manually.</li></ul> <p>If the electric parking brake cannot be applied or the red  (USA only) or  (Canada only) indicator lamp continues to flash:</p> <ul style="list-style-type: none"><li>► Do not continue driving. Consult a qualified specialist workshop.</li><li>► Where necessary, also secure the parked vehicle against rolling away.</li></ul> <p>* The yellow  indicator lamp is lit and the red  indicator lamp (USA only) or  indicator lamp (Canada only) flashes for approximately ten seconds after the electric parking brake has been applied or released. It then remains lit or goes out. The electric parking brake is malfunctioning.</p> <p><b>If the charge level is too low:</b></p> <ul style="list-style-type: none"><li>► Charge the 12 V battery.</li></ul>

Display messages	Possible causes/consequences and ► Solutions
	<p><b>To apply:</b></p> <ul style="list-style-type: none"><li>► switch the ignition off. The electric parking brake will be applied automatically.</li></ul> <p>If the electric parking brake is not to be applied, e.g. at an automatic car wash or when the vehicle is being towed, leave the ignition switched on. This does not include having the vehicle towed with the rear axle raised.</p> <p>If the electric parking brake is not applied automatically:</p> <ul style="list-style-type: none"><li>► Switch the ignition off and switch it back on.</li><li>► Release and then apply the electric parking brake manually (→ page 172).</li></ul> <p>If it is still not possible to apply the electric parking brake:</p> <ul style="list-style-type: none"><li>► Consult a qualified specialist workshop.</li><li>► Where necessary, also secure the parked vehicle against rolling away.</li></ul> <p><b>To release:</b></p> <ul style="list-style-type: none"><li>► If the conditions for automatic release are fulfilled and the electric parking brake is not released automatically, release the electric parking brake manually (→ page 172).</li></ul> <p>If it is still not possible to release the electric parking brake:</p> <ul style="list-style-type: none"><li>► Do not continue driving. Consult a qualified specialist workshop.</li></ul>

Display messages	Possible causes/consequences and ► Solutions
 <p>(USA only)</p>  <p>(Canada only)</p> <p>Please Release Parking Brake</p>	<p>* The red  indicator lamp (USA only) or  indicator lamp (Canada only) is flashing.</p> <p>The electric parking brake is applied while you are driving:</p> <ul style="list-style-type: none"><li>• A condition for automatic release of the electric parking brake has not been fulfilled (→ page 171).</li><li>• You are performing emergency braking using the electric parking brake (→ page 172).</li></ul> <p>► Check the conditions for automatic release of the electric parking brake.</p> <p>► Release the electric parking brake manually.</p>





Display messages	Possible causes/consequences and ► Solutions
<div data-bbox="205 252 362 335"></div> <div data-bbox="201 342 308 368">(USA only)</div> <div data-bbox="205 381 362 464"></div> <div data-bbox="201 470 341 496">(Canada only)</div> <div data-bbox="194 505 462 557">Turn On the Ignition to Release the Parking Brake</div>	<p>* The red  (USA only) or  indicator lamp (Canada only) is lit. You have attempted to release the electric parking brake with the ignition switched off.</p> <ul style="list-style-type: none"> <li>► Switch on the ignition.</li> </ul>
<div data-bbox="205 584 362 667"></div> <div data-bbox="194 673 303 699">(USA only)</div> <div data-bbox="205 711 362 794"></div> <div data-bbox="194 800 336 826">(Canada only)</div> <div data-bbox="194 836 437 856">Check Brake Fluid Level</div>	<p>* There is insufficient brake fluid in the brake fluid reservoir.</p> <div data-bbox="565 629 1696 660" style="background-color: #cccccc; padding: 5px;"> <p><b>▲ WARNING</b> Risk of an accident due to low brake fluid level</p> </div> <p>If the brake fluid level is too low, the braking effect and the braking characteristics may be impaired.</p> <ul style="list-style-type: none"> <li>► Pull over and stop the vehicle safely as soon as possible, paying attention to road and traffic conditions. Do not continue driving under any circumstances.</li> <li>► Consult a qualified specialist workshop.</li> <li>► Do not add brake fluid.</li> </ul>



## 390 Display messages and warning/indicator lamps

Display messages	Possible causes/consequences and ► Solutions
 <p data-bbox="144 342 373 391">Check Brake Pads See Operator's Manual</p>	<ul style="list-style-type: none"><li>* The brakepads have reached the wear limit.<ul style="list-style-type: none"><li>► Consult a qualified specialist workshop.</li></ul></li></ul>

## Driving systems

Display messages	Possible causes/consequences and ► Solutions
 <p data-bbox="144 638 417 686">ATTENTION ASSIST Inoperative</p>	<ul style="list-style-type: none"><li>* ATTENTION ASSIST is malfunctioning.<ul style="list-style-type: none"><li>► Consult a qualified specialist workshop.</li></ul></li></ul>
 <p data-bbox="144 803 417 852">ATTENTION ASSIST: Take a Break!</p>	<ul style="list-style-type: none"><li>* ATTENTION ASSIST has detected fatigue or an increasing lack of concentration on the part of the driver (→ page 227).<ul style="list-style-type: none"><li>► If necessary, take a break.</li></ul></li></ul>

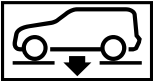
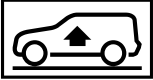
Display messages	Possible causes/consequences and ► Solutions
 <p data-bbox="195 342 458 394">Malfunction Drive at Max. 50 mph</p>	<p data-bbox="524 249 1581 273">* AIRMATIC is functioning only to a limited extent. The vehicle's handling characteristics may be affected.</p> <ul style="list-style-type: none"> <li data-bbox="543 283 1474 307">► Drive in a manner appropriate for the current level, but do not exceed 50 mph (80 km/h).</li> <li data-bbox="543 318 975 341">► Consult a qualified specialist workshop.</li> </ul>
<p data-bbox="195 418 473 491">E-ACTIVE BODY CONTROL Function Limited See Operator's Manual</p>	<p data-bbox="524 418 1618 474">* At least one main function of the E-ACTIVE BODY CONTROL system is malfunctioning. The system is outside the operating temperature range or the on-board electrical system voltage is too low.</p> <div data-bbox="561 498 1696 554" style="border: 1px solid black; padding: 5px;"> <p data-bbox="569 505 1674 554"><b>!</b> <b>NOTE</b> The vehicle's suspension and damping behavior is restricted. The vehicle body may tilt heavily to the side during cornering.</p> </div> <div data-bbox="561 570 1094 664" style="border: 1px solid black; padding: 5px;"> <ul style="list-style-type: none"> <li data-bbox="569 573 778 597">► Drive on carefully.</li> <li data-bbox="569 608 1094 631">► Reduce speed considerably before taking a bend.</li> <li data-bbox="569 642 949 666">► Avoid sudden steering movements.</li> </ul> </div> <ul style="list-style-type: none"> <li data-bbox="543 693 761 716">► Drive on carefully.</li> <li data-bbox="543 727 1073 751">► Reduce speed considerably before taking a bend.</li> <li data-bbox="543 761 931 785">► Avoid sudden steering movements.</li> <li data-bbox="543 795 1443 819">► Once the cause of the problem is no longer present, the system will be available again.</li> </ul>

Display messages	Possible causes/consequences and ► Solutions
<p>Selected Level Not Available When Rear Fog Lamp On</p>	<ul style="list-style-type: none"> <li>* You cannot select off-road level +3.               <ul style="list-style-type: none"> <li>► Switch off the rear fog lamp.</li> </ul> </li> </ul>
<p></p> <p>Lowering</p>	<ul style="list-style-type: none"> <li>* The vehicle level may be lowered for the following reasons:               <ul style="list-style-type: none"> <li>• You have selected a different drive program.</li> <li>• You have exceeded the speed limit.</li> <li>• You have changed the vehicle level by pressing the button.</li> <li>• <b>Operation with a trailer or bicycle rack:</b> if an electrical connection has been correctly made, you have exceeded the speed limit.</li> </ul> </li> </ul>
<p></p> <p>Vehicle Rising</p>	<ul style="list-style-type: none"> <li>* Your vehicle is adjusting to the level you have selected.</li> </ul>
<p></p> <p>Malfunction Drive at Max. 50 mph</p>	<ul style="list-style-type: none"> <li>* At least one main function of the E-ACTIVE BODY CONTROL system is malfunctioning. The system is deactivated.</li> </ul>

Display messages	Possible causes/consequences and ► Solutions
	<p><b>!</b> <b>NOTE</b> The vehicle's suspension and damping behavior has changed significantly, the vehicle body may tilt heavily to the side during cornering.</p> <ul style="list-style-type: none"> <li>► Reduce vehicle speed. Drive on carefully.</li> <li>► Reduce the vehicle speed considerably before taking a curve.</li> <li>► Avoid sudden steering movements.</li> </ul> <ul style="list-style-type: none"> <li>► Continue driving carefully and do not exceed 50 mph (80 km/h).</li> <li>► If possible, stop the vehicle in accordance with the traffic conditions and switch the ignition off and on again.</li> <li>► If the display message still appears, consult a qualified specialist workshop.</li> </ul>
 <p>Malfunction Stop</p>	<p>* There is a serious malfunction affecting the hydraulics of the E-ACTIVE BODY CONTROL system. The system is deactivated.</p> <p><b>!</b> <b>NOTE</b> The vehicle's driving characteristics have changed significantly.</p> <ul style="list-style-type: none"> <li>► Pull over and stop the vehicle safely as soon as possible in accordance with the traffic conditions. Do not continue driving under any circumstances.</li> </ul> <ul style="list-style-type: none"> <li>► Stop the vehicle immediately in accordance with the traffic conditions. Do not continue driving under any circumstances.</li> <li>► Consult a qualified specialist workshop.</li> </ul>

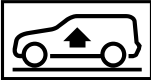
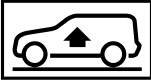
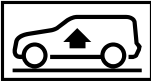
Display messages	Possible causes/consequences and ► Solutions
 <p data-bbox="144 342 328 366">Drive More Slowly</p>	<ul style="list-style-type: none"> <li data-bbox="476 249 1023 273">* You are driving too fast for the selected vehicle level.               <ul style="list-style-type: none"> <li data-bbox="495 283 1179 307">► Drive more slowly and then select the desired vehicle level again.</li> </ul> </li> <li data-bbox="495 335 1548 359">You are driving too quickly with a trailer or the trailer hitch socket is being used, e.g. for a rear cycle rack.               <ul style="list-style-type: none"> <li data-bbox="495 369 944 393">► Read the information on trailer operation.</li> </ul> </li> </ul>
 <p data-bbox="144 502 413 526">Vehicle Rising Please Wait</p>	<ul style="list-style-type: none"> <li data-bbox="476 412 1313 436">* The vehicle level is too low. The vehicle will be raised to the selected vehicle level.               <ul style="list-style-type: none"> <li data-bbox="495 446 1153 470">► Wait until the display message disappears before pulling away.</li> </ul> </li> </ul>
 <p data-bbox="144 643 376 667">Compressor Is Cooling</p>	<ul style="list-style-type: none"> <li data-bbox="476 553 1641 597">* Due to frequent level changes within a short space of time, the compressor first needs to cool down in order to set the selected vehicle level.               <ul style="list-style-type: none"> <li data-bbox="495 608 1591 659">► Drive on in a manner appropriate for the current level. Make sure that there is sufficient ground clearance. When the compressor has cooled down, the vehicle will continue rising to the selected vehicle level.</li> </ul> </li> </ul>
<p data-bbox="144 694 413 769">Active Steering Assist Currently Unavailable See Operator's Manual</p>	<ul style="list-style-type: none"> <li data-bbox="476 694 1563 877">* Active Steering Assist is temporarily unavailable. The ambient conditions are outside the system limits (→ page 195).               <ul style="list-style-type: none"> <li data-bbox="495 763 1563 815">► Drive on. As soon as the ambient conditions are within the system limits, the system will become available again.</li> <li data-bbox="495 825 1171 849">► If necessary, clean the windshield in the camera's field of vision.</li> <li data-bbox="495 859 898 883">► Check the tire pressure if necessary.</li> </ul> </li> </ul>

Display messages	Possible causes/consequences and ► Solutions
Active Steering Assist Inoperative	<p>* Active Steering Assist is malfunctioning. Active Distance Assist DISTRONIC remains available.</p> <p>► Consult a qualified specialist workshop.</p>
	<p>* Active Steering Assist has reached the system limits (→ page 195). You have not steered independently for a considerable period of time.</p> <p>► Take over the steering and drive on in accordance with the traffic conditions.</p>
Beginning Emergency Stop	<p>* Your hands are not on the steering wheel. An emergency stop is being initiated (→ page 198).</p> <p>► Put your hands back on the steering wheel.</p> <p>You can cancel the deceleration at any time by performing one of the following actions:</p> <ul style="list-style-type: none"> <li>• Steering</li> <li>• Depressing the brake or accelerator pedal</li> <li>• Pressing a steering-wheel button</li> <li>• Operating Touch Control</li> <li>• Deactivating Active Distance Assist DISTRONIC</li> </ul>
Active Steering Asst. Currently Unavailable Due to Multiple Emergency Stops	<p>* Active Steering Assist is temporarily unavailable due to multiple emergency stops.</p> <p>► Take over the steering and stop in accordance with the traffic conditions.</p> <p>► Switch the ignition off and switch it back on.</p> <p>Active Steering Assist is available once more.</p>

## 396 Display messages and warning/indicator lamps

Display messages	Possible causes/consequences and ► Solutions
Active Lane Keeping Assist Currently Unavailable See Operator's Manual	<ul style="list-style-type: none"><li>* Active Lane Keeping Assist is temporarily unavailable. The ambient conditions are outside the system limits (→ page 233).<ul style="list-style-type: none"><li>► Drive on. As soon as the ambient conditions are within the system limits, the system will become available again.</li></ul></li></ul>
Active Lane Keeping Assist Inoperative	<ul style="list-style-type: none"><li>* Active Lane Keeping Assist is malfunctioning.<ul style="list-style-type: none"><li>► Consult a qualified specialist workshop.</li></ul></li></ul>
Active Stop & Go Assist Currently Unavailable See Operator's Manual	<ul style="list-style-type: none"><li>* Active Stop-and-Go Assist is temporarily unavailable. Active Distance Assist DISTRONIC and Active Steering Assist are still available. The ambient conditions are outside the system limits (→ page 199).<ul style="list-style-type: none"><li>► Drive on. As soon as the ambient conditions are within the system limits, the system will become available again.</li></ul></li></ul>
Active Stop & Go Assist Inoperative See Operator's Manual	<ul style="list-style-type: none"><li>* Active Stop-and-Go Assist is malfunctioning. Active Stop-and-Go Assist is deactivated. Active Distance Assist DISTRONIC and Active Steering Assist are still available.<ul style="list-style-type: none"><li>► Consult a qualified specialist workshop.</li></ul></li></ul>
Blind Spot Assist Currently Unavailable See Operator's Manual	<ul style="list-style-type: none"><li>* Blind Spot Assist is temporarily unavailable. The system limits have been reached (→ page 230).<ul style="list-style-type: none"><li>► Drive on. Once the cause of the problem is no longer present, the system will be available again.</li></ul></li></ul>







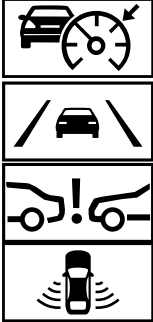

Display messages	Possible causes/consequences and ► Solutions
	or ► If the display message does not disappear, stop the vehicle in accordance with the traffic conditions and restart the engine.
Blind Spot Assist Inoperative	* Blind Spot Assist is malfunctioning. ► Consult a qualified specialist workshop.
Blind Spot Assist Not Available When Towing a Trailer See Operator's Manual	* When you establish the electrical connection to the trailer, Blind Spot Assist is unavailable. ► Press the left-hand Touch Control and acknowledge the display message.
Active Blind Spot Assist Currently Unavailable See Operator's Manual	* Active Blind Spot Assist is temporarily unavailable. The system limits have been reached (→ page 230). ► Drive on. Once the cause of the problem is no longer present, the system will be available again. or ► If the display message does not disappear, stop the vehicle in accordance with the traffic conditions and restart the engine.
Active Blind Spot Assist Inoperative	* Active Blind Spot Assist is malfunctioning. ► Consult a qualified specialist workshop.

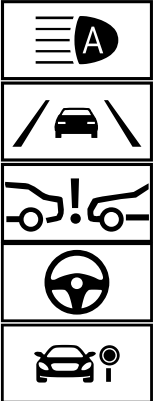
### 398 Display messages and warning/indicator lamps



Display messages	Possible causes/consequences and ► Solutions
Active Blind Spot Asst. Not Available When Towing a Trailer See Operator's Manual	<ul style="list-style-type: none"><li>* When you establish the electrical connection to the trailer, Active Blind Spot Assist is unavailable.<ul style="list-style-type: none"><li>► Press the left-hand Touch Control and acknowledge the display message.</li></ul></li></ul>
Active Parking Assist and PARKTRONIC Inoperative See Operator's Manual	<ul style="list-style-type: none"><li>* Active Parking Assist and Parking Assist PARKTRONIC are malfunctioning.<ul style="list-style-type: none"><li>► Stop the vehicle in accordance with the traffic conditions and restart the engine.</li><li>► If the display message still appears, consult a qualified specialist workshop.</li></ul></li></ul>
Traffic Sign Assist Currently Unavailable See Operator's Manual	<ul style="list-style-type: none"><li>* Traffic Sign Assist is temporarily unavailable.<ul style="list-style-type: none"><li>► Drive on.</li><li>► Once the cause of the problem is no longer present, the system will be available again.</li></ul></li></ul>
Traffic Sign Assist Inoperative	<ul style="list-style-type: none"><li>* Traffic Sign Assist is malfunctioning.<ul style="list-style-type: none"><li>► Stop the vehicle in accordance with the traffic conditions and restart the engine.</li><li>► If the display message still appears, consult a qualified specialist workshop.</li></ul></li></ul>

Display messages	Possible causes/consequences and ► Solutions
 <p data-bbox="195 598 413 648">Currently Unavailable Radar Sensors Dirty</p>	<p data-bbox="528 249 1147 273">* The radar sensor system is malfunctioning. Possible causes:</p> <ul data-bbox="550 285 1221 377" style="list-style-type: none"> <li data-bbox="550 285 772 306">• dirt on the sensors</li> <li data-bbox="550 319 772 339">• heavy rain or snow</li> <li data-bbox="550 352 1221 377">• extended country driving without other traffic, e.g. in the desert</li> </ul> <p data-bbox="547 394 1480 418">Driving systems and driving safety systems may be malfunctioning or temporarily unavailable.</p> <p data-bbox="547 430 1702 480">Once the cause of the problem is no longer present, the driving systems and driving safety systems will be available again.</p> <p data-bbox="547 493 972 516">If the display message does not disappear:</p> <ul data-bbox="547 529 1618 620" style="list-style-type: none"> <li data-bbox="547 529 1618 553">► Pull over and stop the vehicle safely as soon as possible, paying attention to road and traffic conditions.</li> <li data-bbox="547 565 907 589">► Clean all sensors (→ page 299).</li> <li data-bbox="547 601 772 625">► Restart the engine.</li> </ul>

Display messages	Possible causes/consequences and ► Solutions
 <p data-bbox="144 681 421 731">Currently Unavailable Camera View Restricted</p>	<p data-bbox="476 249 962 270">* The camera view is restricted. Possible causes:</p> <ul data-bbox="500 283 1073 373" style="list-style-type: none"> <li data-bbox="500 283 1049 304">• Dirt on the windshield in the camera's field of vision</li> <li data-bbox="500 318 765 338">• Heavy rain, snow or fog</li> <li data-bbox="500 352 1073 372">• Condensation on the windshield in front of the camera</li> </ul> <p data-bbox="495 394 1622 443">❗ Condensation detected on the windshield will be automatically removed using a built-in heater within approximately 12 minutes.</p> <p data-bbox="495 456 1424 477">Driving systems and driving safety systems may be malfunctioning or temporarily unavailable.</p> <p data-bbox="495 491 1646 539">Once the cause of the problem is no longer present, the driving systems and driving safety systems will be available again.</p> <p data-bbox="495 553 920 573">If the display message does not disappear:</p> <ul data-bbox="495 587 1105 643" style="list-style-type: none"> <li data-bbox="495 587 1105 608">► Stop the vehicle in accordance with the traffic conditions.</li> <li data-bbox="495 620 870 641">► Clean the windshield if necessary.</li> </ul>
 <p data-bbox="144 850 181 871">Off</p>	<p data-bbox="476 760 1567 781">* The HOLD function is deactivated because the vehicle is slipping or a condition for activation is not fulfilled.</p> <ul data-bbox="495 794 1604 815" style="list-style-type: none"> <li data-bbox="495 794 1604 815">► Reactivate the HOLD function later or check the activation conditions for the HOLD function (→ page 200).</li> </ul>

Display messages	Possible causes/consequences and ► Solutions
 Inoperative	<ul style="list-style-type: none"> <li>* The Downhill Speed Regulation is malfunctioning.               <ul style="list-style-type: none"> <li>► Consult a qualified specialist workshop.</li> </ul> </li> </ul>
 Not in Curr. Drive Prog.	<ul style="list-style-type: none"> <li>* The Downhill Speed Regulation is not available in the currently selected drive program.               <ul style="list-style-type: none"> <li>► Change the drive program (→ page 157).</li> </ul> </li> </ul>
 Max. Speed 25 mph	<ul style="list-style-type: none"> <li>* The maximum speed of 25 mph (40 km/h) for the Downhill Speed Regulation has been exceeded.               <ul style="list-style-type: none"> <li>► Drive more slowly.</li> </ul> </li> </ul>
 --- mph	<ul style="list-style-type: none"> <li>* Active Distance Assist DISTRONIC cannot be activated as not all activation conditions are fulfilled.               <ul style="list-style-type: none"> <li>► Comply with the activation conditions of Active Distance Assist DISTRONIC (→ page 191).</li> </ul> </li> </ul>

## 402 Display messages and warning/indicator lamps



Display messages	Possible causes/consequences and ► Solutions
 <p>Suspended</p>	<p>* If you depress the accelerator pedal beyond the Active Distance Assist DISTRONIC setting, the system will switch to passive mode (→ page 188).</p>
 <p>Off</p>	<p>* Active Distance Assist DISTRONIC was deactivated. If a warning tone also sounds, Active Distance Assist DISTRONIC has deactivated automatically (→ page 191).</p>
<p>Active Distance Assist Currently Unavailable See Operator's Manual</p>	<p>* Active Distance Assist DISTRONIC is temporarily unavailable. The ambient conditions are outside the system limits (→ page 188).</p> <p>► Drive on. As soon as the ambient conditions are within the system limits, the system will become available again.</p>
<p>Active Distance Assist Inoperative</p>	<p>* Active Distance Assist DISTRONIC is malfunctioning. Other driving systems and driving safety systems may also be malfunctioning.</p> <p>► Consult a qualified specialist workshop.</p>
<p>Active Distance Assist Now Available</p>	<p>* Active Distance Assist DISTRONIC is operational again and can be activated (→ page 191).</p>

Display messages	Possible causes/consequences and ► Solutions
 <p data-bbox="195 344 282 366">--- mph</p>	<ul style="list-style-type: none"> <li>* Cruise control cannot be activated as not all activation conditions are fulfilled.               <ul style="list-style-type: none"> <li>► Observe the activation conditions for cruise control (→ page 185).</li> </ul> </li> </ul>
<p data-bbox="195 391 463 415">Cruise Control Inoperative</p>	<ul style="list-style-type: none"> <li>* Cruise control is malfunctioning.               <ul style="list-style-type: none"> <li>► Consult a qualified specialist workshop.</li> </ul> </li> </ul>
<p data-bbox="195 467 380 491">Cruise Control Off</p>	<ul style="list-style-type: none"> <li>* Cruise control has been deactivated.               <ul style="list-style-type: none"> <li>If there is an additional warning tone, cruise control has been deactivated automatically (→ page 185).</li> </ul> </li> </ul>

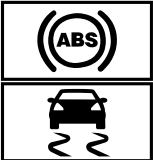
## Driving safety systems

Display messages	Possible causes/consequences and ► Solutions
 <p data-bbox="145 469 408 515">Currently Unavailable See Operator's Manual</p>	<p data-bbox="476 291 924 317">* ABS and ESP® are temporarily unavailable.</p> <p data-bbox="495 325 1458 351">Other driving systems and driving safety systems (e.g. BAS) may also be temporarily unavailable.</p> <p data-bbox="495 359 1609 410">The brake system will continue to operate normally. The braking distance in an emergency braking situation can increase.</p> <div data-bbox="495 428 1644 650" style="border: 1px solid gray; padding: 5px;"><p data-bbox="513 439 1190 467"><b>▲ WARNING</b> Risk of skidding if ABS and ESP® are malfunctioning</p><p data-bbox="513 482 1415 508">The wheels may block during braking and ESP® does not perform any vehicle stabilization.</p><p data-bbox="513 519 1628 569">The steerability and braking characteristics are heavily impaired and the braking distance may increase. In addition, other driving safety systems are switched off.</p><ul data-bbox="513 580 1310 641" style="list-style-type: none"><li data-bbox="513 580 728 606">► Drive on carefully.</li><li data-bbox="513 616 1310 641">► Have ABS and ESP® checked immediately at a qualified specialist workshop.</li></ul></div> <ul data-bbox="495 669 1633 753" style="list-style-type: none"><li data-bbox="495 669 1572 720">► Drive carefully on a suitable stretch of road, making slight steering movements at a speed above 19 mph (30 km/h).</li><li data-bbox="495 730 1633 753">► If the display message does not disappear, consult a qualified specialist workshop immediately. Drive carefully.</li></ul>

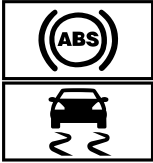

Display messages	Possible causes/consequences and ► Solutions
 <p data-bbox="195 428 467 477">Inoperative See Operator's Manual</p>	<p data-bbox="524 252 1665 370">* ABS and ESP® are malfunctioning. Other driving systems and driving safety systems (e.g. BAS) may also be malfunctioning. The brake system will continue to operate normally. The braking distance in an emergency braking situation can increase.</p> <div data-bbox="550 391 1696 612" style="background-color: #f0f0f0; padding: 10px;"> <p data-bbox="565 401 1240 428"><b>▲ WARNING</b> Risk of skidding if ABS and ESP® are malfunctioning</p> <p data-bbox="565 443 1677 529">The wheels may block during braking and ESP® does not perform any vehicle stabilization. The steerability and braking characteristics are heavily impaired and the braking distance may increase. In addition, other driving safety systems are switched off.</p> <ul data-bbox="565 539 1360 601" style="list-style-type: none"> <li data-bbox="565 539 778 566">► Drive on carefully.</li> <li data-bbox="565 577 1360 601">► Have ABS and ESP® checked immediately at a qualified specialist workshop.</li> </ul> </div>
 <p data-bbox="195 722 458 770">Currently Unavailable See Operator's Manual</p>	<p data-bbox="524 629 1424 692">* ESP® is temporarily unavailable. Other driving systems and driving safety systems (e.g. BAS) may also be malfunctioning.</p> <div data-bbox="550 707 1696 857" style="background-color: #f0f0f0; padding: 10px;"> <p data-bbox="565 717 1134 744"><b>▲ WARNING</b> Risk of skidding if ESP® is malfunctioning</p> <p data-bbox="565 759 1665 811">If ESP® is malfunctioning, ESP® cannot carry out vehicle stabilization. In addition, other driving safety systems are switched off.</p> <ul data-bbox="565 821 778 848" style="list-style-type: none"> <li data-bbox="565 821 778 848">► Drive on carefully.</li> </ul> </div>

Display messages	Possible causes/consequences and ► Solutions
	<ul style="list-style-type: none"> <li>► Have ESP® checked at a qualified specialist workshop.</li> <li>► Drive carefully on a suitable stretch of road, making slight steering movements at a speed above 19 mph (30 km/h).</li> <li>► If the display message does not disappear, consult a qualified specialist workshop immediately. Drive carefully.</li> </ul>
<div style="text-align: center;">  </div> <p>Inoperative See Operator's Manual</p>	<p>* ESP® is malfunctioning. Other driving systems and driving safety systems (e.g. BAS) may also be malfunctioning. The brake system will continue to operate normally. The braking distance in an emergency braking situation can increase.</p> <div style="background-color: #e0e0e0; padding: 5px; margin-bottom: 10px;"> <p><b>▲ WARNING</b> Risk of skidding if ESP® is malfunctioning</p> </div> <p>If ESP® is malfunctioning, ESP® cannot carry out vehicle stabilization. In addition, other driving safety systems are switched off.</p> <ul style="list-style-type: none"> <li>► Drive on carefully.</li> <li>► Have ESP® checked at a qualified specialist workshop.</li> </ul>

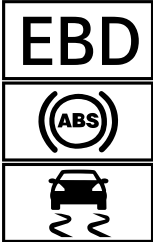
Display messages	Possible causes/consequences and ► Solutions
 <p data-bbox="195 513 469 560">Inoperative See Operator's Manual</p>	<p data-bbox="524 249 1424 311">* EBD, ABS and ESP® are malfunctioning. Other driving systems and driving safety systems (e.g. BAS) may also be malfunctioning.</p> <div data-bbox="547 329 1696 547" style="border: 1px solid gray; padding: 5px;"> <p data-bbox="565 339 1295 365"><b>▲ WARNING</b> Risk of skidding if EBD, ABS and ESP® are malfunctioning</p> <p data-bbox="565 381 1465 407">The wheels may block during braking and ESP® does not perform any vehicle stabilization.</p> <p data-bbox="565 417 1683 469">The steerability and braking characteristics are heavily impaired and the braking distance may increase. In addition, other driving safety systems are switched off.</p> <ul style="list-style-type: none"> <li data-bbox="565 479 778 505">► Drive on carefully.</li> <li data-bbox="565 515 1387 541">► Have the brake system checked immediately at a qualified specialist workshop.</li> </ul> </div>
<p data-bbox="195 588 469 666">Active Brake Assist Functions Currently Limited See Operator's Manual</p>	<p data-bbox="524 588 1683 640">* <b>Vehicles with the Driving Assistance Package:</b> Active Brake Assist with cross-traffic function, Evasive Steering Assist or PRE-SAFE® PLUS are temporarily unavailable or only partially available.</p> <p data-bbox="543 650 1696 702"><b>Vehicles without the Driving Assistance Package:</b> Active Brake Assist is temporarily unavailable or only partially available.</p> <p data-bbox="543 712 1225 738">The ambient conditions are outside the system limits (→ page 180).</p> <ul style="list-style-type: none"> <li data-bbox="543 749 1613 800">► Drive on. As soon as the ambient conditions are within the system limits, the system will become available again.</li> <li data-bbox="543 811 1696 857">► If the display message does not disappear, stop the vehicle in accordance with the traffic conditions and restart the engine.</li> </ul>

## 408 Display messages and warning/indicator lamps

Display messages	Possible causes/consequences and ► Solutions
<a href="#">Active Brake Assist Functions Limited See Operator's Manual</a>	<ul style="list-style-type: none"><li>* <b>Vehicles with Driving Assistance Package:</b> Active Brake Assist with cross-traffic function, Evasive Steering Assist or PRE-SAFE® PLUS is malfunctioning.</li><li><b>Vehicles without Driving Assistance Package:</b> Active Brake Assist is malfunctioning.</li></ul> <ul style="list-style-type: none"><li>► Consult a qualified specialist workshop.</li></ul>



### Mercedes me connect

Display messages	Possible causes/consequences and ► Solutions
<a href="#">Mercedes me connect Services Limited See Operator's Manual</a>	<ul style="list-style-type: none"><li>* The vehicle functions for malfunction detection are restricted. At least one of the main functions of the Mercedes me connect system is malfunctioning.</li></ul> <ul style="list-style-type: none"><li>► Observe the notes on the diagnostics connection (→ page 27).</li><li>► Consult a qualified specialist workshop.</li></ul>
 Inoperative	<ul style="list-style-type: none"><li>* At least one of the main functions of the Mercedes me connect system or of the SOS emergency call system is malfunctioning.</li></ul> <ul style="list-style-type: none"><li>► Consult a qualified specialist workshop.</li></ul>

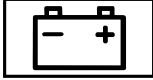
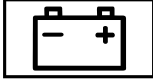
## Battery

Display messages	Possible causes/consequences and ► Solutions
 <p data-bbox="194 383 443 429">12 V Battery See Operator's Manual</p>	<ul style="list-style-type: none"> <li>* The engine is off and the charge level is too low.               <ul style="list-style-type: none"> <li>► Switch off electrical consumers that are not required.</li> </ul> </li> <li>To charge the 12 V battery:               <ul style="list-style-type: none"> <li>► Leave the engine running for a few minutes, or drive an extended distance.</li> </ul> </li> <li>* If the message appears while the engine is running, this indicates an on-board electrical system malfunction.               <ul style="list-style-type: none"> <li>► Consult a qualified specialist workshop.</li> </ul> </li> </ul>
 <p data-bbox="194 611 425 637">See Operator's Manual</p>	<ul style="list-style-type: none"> <li>* The 12 V battery is not being charged.               <div style="border: 1px solid gray; padding: 5px; margin: 5px 0;"> <p><b>!</b> <b>NOTE</b> Possible engine damage if you continue driving</p> <ul style="list-style-type: none"> <li>► Do not continue driving under any circumstances.</li> <li>► Consult a qualified specialist workshop.</li> </ul> </div> <ul style="list-style-type: none"> <li>► Pull over and stop the vehicle safely and switch off the engine, paying attention to road and traffic conditions.</li> <li>► Consult a qualified specialist workshop.</li> </ul> </li> </ul>

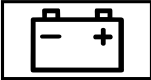
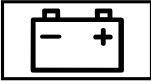
## 410 Display messages and warning/indicator lamps



Display messages	Possible causes/consequences and ► Solutions
 <p data-bbox="144 342 393 391">Stop Vehicle See Operator's Manual</p>	<p data-bbox="476 249 1245 273">* The 12 V battery is no longer being charged and the charge level is too low.</p> <div data-bbox="500 291 1646 412" style="border: 1px solid black; padding: 5px;"><p data-bbox="513 301 1092 325"><b>!</b> <b>NOTE</b> Possible engine damage if you continue driving</p><ul data-bbox="513 342 1045 401" style="list-style-type: none"><li data-bbox="513 342 1045 366">► Do not continue driving under any circumstances.</li><li data-bbox="513 373 1045 401">► Consult a qualified specialist workshop.</li></ul></div> <ul data-bbox="495 428 1480 522" style="list-style-type: none"><li data-bbox="495 428 1480 452">► Stop the vehicle immediately in accordance with the traffic conditions. Do not continue driving.</li><li data-bbox="495 459 750 483">► Switch off the engine.</li><li data-bbox="495 491 925 522">► Consult a qualified specialist workshop.</li></ul>
 <p data-bbox="144 632 412 681">Stop Vehicle Leave Engine Running</p>	<p data-bbox="476 539 894 563">* The 12 V battery charge level is too low.</p> <ul data-bbox="495 570 1480 698" style="list-style-type: none"><li data-bbox="495 570 1480 594">► Stop the vehicle immediately in accordance with the traffic conditions. Do not continue driving.</li><li data-bbox="495 601 787 625">► Leave the engine running.</li><li data-bbox="495 632 1153 656">► Wait until the display message disappears before pulling away.</li><li data-bbox="495 664 1393 698">► <b>If the display message does not disappear:</b> consult a qualified specialist workshop.</li></ul>
 <p data-bbox="144 812 393 860">48 V Battery See Operator's Manual</p>	<p data-bbox="476 718 1535 742">* The 48 V on-board electrical system has function restrictions. Convenience functions may be restricted.</p> <ul data-bbox="495 750 1055 773" style="list-style-type: none"><li data-bbox="495 750 1055 773">► Consult a qualified specialist workshop immediately.</li></ul>

Display messages	Possible causes/consequences and ► Solutions
 <p data-bbox="195 342 463 391">Please Wait Charging 48 V Battery...</p>	<p data-bbox="524 249 1683 301">* The 48 V battery is discharged. You have switched on the ignition while the 12 V battery was being charged with a suitable charger or while another vehicle was providing starting assistance.</p> <p data-bbox="543 311 1655 363">The discharged 48 V battery is charged automatically via the voltage converter. After a few minutes, the <b>Engine Can Now Be Started</b> display message will be shown on the multifunction display.</p> <ul style="list-style-type: none"> <li data-bbox="543 373 750 399">► Start the engine.</li> <li data-bbox="543 410 1655 456">► Drive the vehicle for a while to charge the 12 V battery and the 48 V battery after disconnecting the charger from the vehicle.</li> </ul> <p data-bbox="543 482 1424 508">If the <b>Engine Can Now Be Started</b> display message does not appear after a few minutes:</p> <ul style="list-style-type: none"> <li data-bbox="543 519 870 544">► Try to start the engine again.</li> <li data-bbox="543 555 1258 581">► If the engine does not start, consult a qualified specialist workshop.</li> </ul>
<p data-bbox="195 594 445 643">Cannot Start Engine See Operator's Manual</p>	<p data-bbox="524 594 1363 620">* The charge level of the 48 V battery is too low. You can no longer start the engine.</p> <ul style="list-style-type: none"> <li data-bbox="543 630 1116 656">► Switch off electrical consumers that are not required.</li> <li data-bbox="543 667 1696 739">► Connect a suitable charger approved for Mercedes-Benz with sufficient charge output to the jump-start connection point of the 12 V battery (→ page 311). The 48 V battery is charged via the voltage converter in the vehicle.</li> </ul>
<p data-bbox="195 757 473 783">Engine Can Now Be Started</p>	<p data-bbox="524 757 1295 783">* The 48 V battery has been charged automatically via the voltage converter.</p> <ul style="list-style-type: none"> <li data-bbox="543 793 1548 819">► Start the engine and drive the vehicle for a while to charge the 12 V battery and the 48 V battery.</li> </ul>

### Tire pressure monitor

Display messages	Possible causes/consequences and ► Solutions
Tire Press. Monitor Currently Unavailable	<p>* There is interference from a powerful radio signal source. As a result, no signals from the tire pressure sensor are being received. The tire pressure monitor is temporarily unavailable.</p> <p>► Drive on. The tire pressure monitor will restart automatically as soon as the cause has been rectified.</p>
Tire Press. Monitor Inoperative	<p>* The tire pressure monitor is malfunctioning.</p> <div style="border: 1px solid gray; padding: 5px; margin: 5px 0;"> <p><b>▲ WARNING</b> There is a risk of an accident if the tire pressure monitoring system is malfunctioning</p> <p>The tire pressure monitoring system cannot issue a warning if there is pressure loss in one or more of the tires. Tires with insufficient tire pressure may impair the driving characteristics as well as steering and braking.</p> <p>► Have the tire pressure monitoring system checked at a qualified specialist workshop.</p> </div>
Tire Pressure Monitor Inoperative No Wheel Sensors	<p>* The wheels installed do not have suitable tire pressure sensors. The tire pressure monitor is deactivated.</p> <p>► Install wheels with suitable tire pressure sensors.</p>
 <p>Wheel Sensor(s) Missing</p>	<p>* There is no signal from the tire pressure sensor of one or more wheels. No pressure value is displayed for the affected tire.</p> <p>► Have the faulty tire pressure sensor replaced at a qualified specialist workshop.</p>





Display messages	Possible causes/consequences and ► Solutions
 <p data-bbox="195 342 316 365">Check Tires</p>	<p data-bbox="524 249 1550 272">* The tire pressure in one or more tires has dropped significantly. The wheel position will be displayed.</p> <div data-bbox="547 291 1702 557" style="border: 1px solid gray; padding: 5px;"> <p data-bbox="565 301 1230 324">▲ <b>WARNING</b> Risk of an accident due to insufficient tire pressure</p> <ul data-bbox="565 342 1467 433" style="list-style-type: none"> <li>• The tires can burst.</li> <li>• The tires can wear excessively and/or unevenly.</li> <li>• The driving characteristics as well as the steering and braking may be greatly impaired.</li> </ul> <p data-bbox="565 453 981 474">You could then lose control of the vehicle.</p> <ul data-bbox="565 487 1021 544" style="list-style-type: none"> <li>► Observe the recommended tire pressures.</li> <li>► Adjust the tire pressure if necessary.</li> </ul> </div> <ul data-bbox="547 572 1156 629" style="list-style-type: none"> <li>► Stop the vehicle in accordance with the traffic conditions.</li> <li>► Check the tire pressure (→ page 321) and the tires.</li> </ul>
 <p data-bbox="195 743 445 790">Please Correct Tire Pressure</p>	<p data-bbox="524 650 1646 697">* The tire pressure is too low in at least one of the tires, or the difference in tire pressure between the individual wheels is too great.</p> <ul data-bbox="547 710 1507 767" style="list-style-type: none"> <li>► Check the tire pressure and add air, if necessary.</li> <li>► When the tire pressure is correct, restart the tire pressure monitoring system (→ page 326).</li> </ul>



Display messages	Possible causes/consequences and ► Solutions
 <p data-bbox="144 342 399 366">Warning Tire Malfunction</p>	<p data-bbox="476 249 1471 273">* The tire pressure in one or more tires has dropped suddenly. The wheel position will be displayed.</p> <div data-bbox="500 291 1644 522"><p data-bbox="513 301 1134 325">▲ <b>WARNING</b> Risk of an accident from driving with a flat tire</p><ul data-bbox="513 339 1419 401" style="list-style-type: none"><li data-bbox="513 339 944 363">• The tires can overheat and cause a fire.</li><li data-bbox="513 373 1419 401">• The driving characteristics as well as the steering and braking may be greatly impaired.</li></ul><p data-bbox="513 415 931 439">You could then lose control of the vehicle.</p><ul data-bbox="513 453 861 508" style="list-style-type: none"><li data-bbox="513 453 861 477">► Do not drive on with a flat tire.</li><li data-bbox="513 487 861 508">► Observe the notes on flat tires.</li></ul></div> <p data-bbox="495 539 833 563">Notes on flat tires (→ page 303).</p> <ul data-bbox="495 573 1110 629" style="list-style-type: none"><li data-bbox="495 573 1110 597">► Stop the vehicle in accordance with the traffic conditions.</li><li data-bbox="495 608 691 629">► Check the tires.</li></ul>
<p data-bbox="144 650 321 674">Tires Overheated</p>	<p data-bbox="476 650 1641 698">* At least one tire is overheating. The affected tires are displayed in red. At temperatures close to the limit value, the tires are displayed in yellow.</p> <div data-bbox="500 715 1644 832"><p data-bbox="513 726 1208 750">▲ <b>WARNING</b> Risk of an accident from driving with overheated tires</p><p data-bbox="513 767 787 791">Overheated tires can burst.</p><ul data-bbox="513 801 972 825" style="list-style-type: none"><li data-bbox="513 801 972 825">► Reduce speed so that the tires cool down.</li></ul></div>

Display messages	Possible causes/consequences and ► Solutions
<p>Decrease Speed</p>	<p>* At least one tire is overheating. The affected tires are displayed in red. At temperatures close to the limit value, the tires are displayed in yellow.</p> <div style="border: 1px solid gray; padding: 5px; margin-top: 10px;"> <p><b>▲ WARNING</b> Risk of an accident from driving with overheated tires</p> <p>Overheated tires can burst.</p> <p>► Reduce speed so that the tires cool down.</p> </div>

## Engine oil

Display messages	Possible causes/consequences and ► Solutions
<div style="border: 1px solid black; padding: 5px; text-align: center; margin-bottom: 5px;">  </div> <p>Check Engine Oil Level (Add 1 quart)</p>	<p>* The engine oil level has dropped to the minimum level.</p> <div style="border: 1px solid gray; padding: 5px; margin-top: 10px;"> <p><b>! NOTE</b> Engine damage caused by driving with insufficient engine oil</p> <p>► Avoid long journeys with insufficient engine oil.</p> </div> <p>► When next refueling, add 1.1 US qt (1 l) of engine oil (→ page 292).</p> <p>Notes on engine oil (→ page 359).</p>

Display messages	Possible causes/consequences and ► Solutions
 <p data-bbox="144 342 421 366">Engine Oil Reduce Oil Level</p>	<p data-bbox="476 249 802 273">* The engine oil level is too high.</p> <div data-bbox="500 294 1646 335" style="border: 1px solid gray; padding: 5px;"> <p data-bbox="513 301 1179 325">! <b>NOTE</b> Engine damage caused by driving with excess engine oil</p> </div> <div data-bbox="500 339 1646 381" style="border: 1px solid gray; padding: 5px;"> <p data-bbox="513 347 975 370">► Avoid long journeys with excess engine oil.</p> </div> <p data-bbox="495 394 1430 418">► Consult a qualified specialist workshop immediately and have the engine oil level reduced.</p>
 <p data-bbox="144 529 408 578">Engine Oil Level Low Stop Vehicle Turn Engine Off</p>	<p data-bbox="476 436 796 459">* The engine oil level is too low.</p> <div data-bbox="500 480 1646 522" style="border: 1px solid gray; padding: 5px;"> <p data-bbox="513 487 1221 511">! <b>NOTE</b> Engine damage caused by driving with insufficient engine oil</p> </div> <div data-bbox="500 526 1646 567" style="border: 1px solid gray; padding: 5px;"> <p data-bbox="513 533 1018 557">► Avoid long journeys with insufficient engine oil.</p> </div> <p data-bbox="495 581 1480 605">► Stop the vehicle immediately in accordance with the traffic conditions. Do not continue driving.</p> <p data-bbox="495 618 746 642">► Switch off the engine.</p> <p data-bbox="495 655 994 679">► Add 1.1 US qt (1 l) of engine oil (→ page 292).</p> <p data-bbox="495 693 790 716">► Check the engine oil level.</p> <p data-bbox="495 730 838 754">Notes on engine oil (→ page 359).</p>

Display messages	Possible causes/consequences and ► Solutions
 <p data-bbox="197 344 445 394">Engine Oil Pressure Stop Switch Off Engine</p>	<p data-bbox="524 249 814 272">* The oil pressure is too low.</p> <div data-bbox="565 298 1696 335" style="border: 1px solid black; padding: 5px;"> <p data-bbox="565 303 1295 326">! <b>NOTE</b> Engine damage caused by driving with insufficient oil pressure</p> </div> <p data-bbox="565 344 1023 367">► Avoid driving with insufficient oil pressure.</p> <ul data-bbox="543 396 1531 453" style="list-style-type: none"> <li data-bbox="543 396 1531 419">► Stop the vehicle immediately in accordance with the traffic conditions. Do not continue driving.</li> <li data-bbox="543 427 977 453">► Consult a qualified specialist workshop.</li> </ul>
 <p data-bbox="197 565 467 615">Engine Oil Level Cannot Be Measured</p>	<p data-bbox="524 470 1541 493">* The electrical connection to the oil level sensor has been interrupted or the oil level sensor is faulty.</p> <ul data-bbox="543 505 977 528" style="list-style-type: none"> <li data-bbox="543 505 977 528">► Consult a qualified specialist workshop.</li> </ul>

### Warning and indicator lamps

#### Overview of indicator and warning lamps

Some systems will perform a self-test when the ignition is switched on. Some indicator and warning lamps may briefly light up or flash. This behavior is non-critical. These indicator and warning lamps indicate a malfunction only if they

light up or flash after the engine has been started or during a journey.





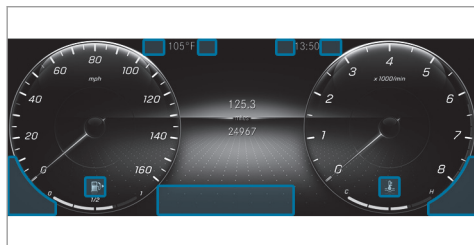

## 418 Display messages and warning/indicator lamps

### Instrument Display



Depending on the display setting, the positions of the indicator lamps on the Instrument Display may differ from the example shown.

#### Indicator and warning lamps:

-  Restraint system (→ page 419)
-  Seat belt (→ page 419)
-  Electric power steering (→ page 420)
-  Coolant temperature (→ page 421)
-  Check Engine (→ page 421)
-  Electrical malfunction (→ page 421)



Reserve fuel with fuel filler flap location indicator (→ page 421)



USA: electric parking brake (red) (→ page 424)



Canada: electric parking brake (red) (→ page 424)



Electric parking brake (yellow) (→ page 424)



USA: brakes (red) (→ page 424)



Canada: brakes (red) (→ page 424)



Distance warning (→ page 426)



AIRMATIC/E-ACTIVE BODY CONTROL (→ page 426)



ABS (→ page 427)



ESP® (→ page 427)



ESP® OFF (→ page 427)



Tire pressure monitoring system (→ page 429)



Parking lamps (→ page 121)



Low beam (→ page 121)



High beam (→ page 122)





Turn signal light (→ page 122)



Rear fog lamp (→ page 121)

## Occupant safety

Warning/indicator lamp	Possible causes/consequences and ► Solutions
 <p data-bbox="195 384 452 433">Restraint system warning lamp</p>	<p data-bbox="506 291 1215 314">The red restraint system warning lamp is lit while the engine is running.</p> <p data-bbox="506 325 1049 349">*The restraint system is malfunctioning (→ page 37).</p> <div data-bbox="532 366 1696 484" style="border: 1px solid gray; padding: 5px;"> <p data-bbox="543 377 1271 400"><b>▲ WARNING</b> Risk of injury due to malfunctions in the restraint system</p> <p data-bbox="543 415 1641 439">Components in the restraint system may be activated unintentionally or not deploy as planned in an accident.</p> <p data-bbox="543 449 1535 473">► Have the restraint system checked and repaired immediately at a qualified specialist workshop.</p> </div> <ul data-bbox="532 501 1086 594" style="list-style-type: none"> <li data-bbox="532 501 746 525">► Drive on carefully.</li> <li data-bbox="532 535 1042 559">► Note the messages on the multifunction display.</li> <li data-bbox="532 569 1086 593">► Consult a qualified specialist workshop immediately.</li> </ul>
 <p data-bbox="195 708 426 757">Seat belt warning lamp flashes</p>	<p data-bbox="506 615 1308 639">The red seat belt warning lamp flashes and an intermittent warning tone sounds.</p> <p data-bbox="506 649 1437 673">* The driver or front passenger has not fastened their seat belt while the vehicle is in motion.</p> <ul data-bbox="532 683 1073 774" style="list-style-type: none"> <li data-bbox="532 683 912 707">► Fasten your seat belt (→ page 41).</li> <li data-bbox="506 717 994 741">* There are objects on the front passenger seat.</li> <li data-bbox="532 752 1073 775">► Remove the objects from the front passenger seat.</li> </ul>

## 420 Display messages and warning/indicator lamps

Warning/indicator lamp	Possible causes/consequences and ► Solutions
 <p data-bbox="144 342 376 391">Seat belt warning lamp lights up</p>	<p data-bbox="456 249 1332 308">The red seat belt warning lamp will light up for six seconds once the engine has started. In addition, a warning tone may sound.</p> <p data-bbox="463 317 1400 342">*The seat belt warning lamp reminds the driver and front passenger to fasten their seat belts.</p> <ul data-bbox="476 353 864 379" style="list-style-type: none"><li>► Fasten your seat belt (→ page 41).</li></ul> <p data-bbox="476 394 1452 418">If you have placed objects on the front passenger seat, the seat belt warning lamp may remain lit.</p>

## Vehicle

Warning/indicator lamp	Possible causes/consequences and ► Solutions
 <p data-bbox="144 654 376 703">Electric power steering warning lamp (red)</p>	<p data-bbox="456 561 1234 587">The red electric power steering warning lamp is lit while the engine is running.</p> <p data-bbox="463 595 1086 621">*The power assistance or the steering itself is malfunctioning.</p> <div data-bbox="482 640 1644 816" style="border: 1px solid gray; padding: 5px;"><p data-bbox="493 648 1138 674"><b>▲ WARNING</b> Risk of accident if steering capability is impaired</p><p data-bbox="493 686 1397 712">If the steering does not function as intended, the vehicle's operating safety is jeopardized.</p><ul data-bbox="493 721 1604 806" style="list-style-type: none"><li>► Pull over and stop the vehicle safely as soon as possible, paying attention to road and traffic conditions. Do not continue driving under any circumstances.</li><li>► Consult a qualified specialist workshop.</li></ul></div> <ul data-bbox="476 835 994 860" style="list-style-type: none"><li>► Note the messages on the multifunction display.</li></ul>



## Engine

## Warning/indicator lamp



Coolant warning lamp

## Possible causes/consequences and ► Solutions

The red coolant warning lamp is lit while the engine is running.

\*Possible causes:

- The temperature sensor is malfunctioning
- The coolant level is too low
- The air supply to the radiator is obstructed
- The radiator fan is faulty

If there is an additional warning tone, the coolant temperature has exceeded the maximum permissible temperature.

**▲ WARNING** Danger of burns when opening the hood

If you open the hood when the engine has overheated or during a fire in the engine compartment, you could come into contact with hot gases or other escaping operating fluids.



- Before opening the hood, allow the engine to cool down.
- In the event of a fire in the engine compartment, keep the hood closed and call the fire service.



► Pull over and stop the vehicle safely and switch off the engine, paying attention to road and traffic conditions. Do not continue driving.

► Note the messages on the multifunction display.



If the coolant temperature display is at the lower end of the temperature scale:



## 422 Display messages and warning/indicator lamps

Warning/indicator lamp	Possible causes/consequences and ► Solutions
	<ul style="list-style-type: none"><li>► Consult a qualified specialist workshop.</li></ul> or <ul style="list-style-type: none"><li>► Exit the vehicle and keep a safe distance from it until the engine has cooled down.</li><li>► Check the coolant level (→ page 293).</li><li>► Make sure that the air supply to the radiator is not obstructed.</li><li>► Avoiding high loads on the engine, drive to the nearest qualified specialist workshop. In doing so, ensure that the coolant temperature display remains below the red area.</li></ul>
 <p>Engine diagnosis warning lamp</p>	<p>The yellow Check Engine warning lamp is lit while the engine is running.</p> <p>*A malfunction has occurred in the engine, the exhaust system or the fuel system.</p> <p>The emission limit values may be exceeded and the engine may be in emergency mode.</p> <p>In some states, legal requirements stipulate that you must immediately consult a qualified specialist workshop as soon as the yellow Check Engine warning lamp lights up.</p> <ul style="list-style-type: none"><li>► Have the vehicle checked as soon as possible at a qualified specialist workshop.</li></ul>
 <p>Electrical malfunction warning lamp</p>	<p>The red electrical fault warning lamp is lit.</p> <p>* There is a fault in the electrics.</p> <ul style="list-style-type: none"><li>► Note the messages on the multifunction display.</li></ul>



Warning/indicator lamp	Possible causes/consequences and ► Solutions
 <p data-bbox="195 342 463 391">Fuel reserve warning lamp flashes</p>	<p data-bbox="510 249 1184 275">The yellow fuel reserve warning lamp lights up while you are driving.</p> <p data-bbox="510 283 1683 335">*There has been pressure loss in the fuel system. The fuel filler cap is not closed correctly or the fuel system is leaking.</p> <ul data-bbox="528 343 802 369" style="list-style-type: none"><li data-bbox="528 343 802 369">► Close the fuel filler cap.</li></ul> <p data-bbox="528 396 1064 422">If the fuel filler cap has already been closed correctly:</p> <ul data-bbox="528 430 962 456" style="list-style-type: none"><li data-bbox="528 430 962 456">► Consult a qualified specialist workshop.</li></ul>
 <p data-bbox="195 565 463 614">Fuel reserve warning lamp lights up</p>	<p data-bbox="510 472 1249 498">The yellow fuel reserve warning lamp lights up while the engine is running.</p> <p data-bbox="510 506 1045 532">* The fuel supply has dropped into the reserve range.</p> <ul data-bbox="528 540 635 566" style="list-style-type: none"><li data-bbox="528 540 635 566">► Refuel.</li></ul>

## Brakes

Warning/indicator lamp	Possible causes/consequences and ► Solutions
<p data-bbox="155 294 310 373"></p> <p data-bbox="144 381 421 433">Electric parking brake indicator lamp (red) (USA only)</p> <p data-bbox="155 439 310 519"></p> <p data-bbox="144 526 421 609">Electric parking brake indicator lamp (red) (Canada only)</p> <p data-bbox="155 615 310 695"></p> <p data-bbox="144 702 421 754">The electric parking brake (yellow) indicator lamp</p>	<p data-bbox="452 288 1062 313">The red electric parking brake indicator lamp flashes or is lit.</p> <p data-bbox="452 322 1369 348">The yellow electric parking brake indicator lamp also lights up in the event of a malfunction.</p> <p data-bbox="452 356 999 382">* ► Note the messages on the multifunction display.</p>

Warning/indicator lamp	Possible causes/consequences and ► Solutions
<div data-bbox="205 253 362 334">  </div> <p data-bbox="195 342 452 394">Brake warning lamp (USA only)</p> <div data-bbox="205 399 362 480">  </div> <p data-bbox="195 488 473 540">Brake system warning lamp (Canada only)</p>	<p data-bbox="504 249 1188 275">The red brake system warning lamp is lit while the engine is running.</p> <p data-bbox="513 283 696 307">*Possible causes:</p> <ul data-bbox="534 319 1480 377" style="list-style-type: none"> <li data-bbox="534 319 1480 344">• The brake force boosting is malfunctioning and the braking characteristics may be affected.</li> <li data-bbox="534 350 1147 377">• There is insufficient brake fluid in the brake fluid reservoir.</li> </ul> <p data-bbox="524 394 1045 420">► Note the messages on the multifunction display.</p> <div data-bbox="537 436 1696 477" style="background-color: #e0e0e0; padding: 5px;"> <p data-bbox="543 446 1378 472">▲ <b>WARNING</b> Risk of accident and injury if brake force boosting is malfunctioning</p> </div> <p data-bbox="543 485 1674 537">If brake force boosting is malfunctioning, increased brake pedal force may be necessary for braking. The braking characteristics may be impaired. The braking distance can increase in emergency braking situations.</p> <ul data-bbox="543 547 1184 605" style="list-style-type: none"> <li data-bbox="543 547 1184 572">► Stop in a safe location immediately. Do not continue driving.</li> <li data-bbox="543 578 981 605">► Consult a qualified specialist workshop.</li> </ul> <div data-bbox="537 630 1696 672" style="background-color: #e0e0e0; padding: 5px;"> <p data-bbox="543 641 1169 667">▲ <b>WARNING</b> Risk of an accident due to low brake fluid level</p> </div> <p data-bbox="543 680 1548 706">If the brake fluid level is too low, the braking effect and the braking characteristics may be impaired.</p> <ul data-bbox="543 715 1655 836" style="list-style-type: none"> <li data-bbox="543 715 1655 767">► Pull over and stop the vehicle safely as soon as possible, paying attention to road and traffic conditions. Do not continue driving under any circumstances.</li> <li data-bbox="543 772 981 798">► Consult a qualified specialist workshop.</li> <li data-bbox="543 803 814 836">► Do not add brake fluid.</li> </ul>



### Driving systems

Warning/indicator lamp	Possible causes/consequences and ► Solutions
 <p>Warning lamp for distance warning function</p>	<p>The red distance warning lamp lights up while the vehicle is in motion.</p> <ul style="list-style-type: none"> <li>* The distance to the vehicle in front is too small for the speed selected.</li> </ul> <p>If there is an additional warning tone, you are approaching an obstacle at too high a speed.</p> <ul style="list-style-type: none"> <li>► Be prepared to brake immediately.</li> <li>► Increase the distance.</li> </ul> <p>Function of Active Brake Assist (→ page 180).</p>
 <p>Suspension warning lamp (yellow)</p>	<p>The yellow AIRMATIC/E-ACTIVE BODY CONTROL warning lamp is lit.</p> <ul style="list-style-type: none"> <li>* A fault has occurred in the AIRMATIC/E-ACTIVE BODY CONTROL.</li> </ul> <ul style="list-style-type: none"> <li>► Note the messages on the multifunction display.</li> </ul>
 <p>Suspension warning lamp (red)</p>	<p>The red E-ACTIVE BODY CONTROL warning lamp is lit.</p> <ul style="list-style-type: none"> <li>* There is a fault in the E-ACTIVE BODY CONTROL.</li> </ul> <div style="border: 1px solid black; padding: 5px; margin-top: 10px;"> <p><b>! NOTE</b> The vehicle's driving characteristics have changed significantly.</p> <ul style="list-style-type: none"> <li>► Pull over and stop the vehicle safely as soon as possible in accordance with the traffic conditions. Do not continue driving under any circumstances.</li> </ul> </div>

Warning/indicator lamp	Possible causes/consequences and ► Solutions
	<ul style="list-style-type: none"> <li>► Note the messages on the multifunction display.</li> <li>► Stop the vehicle immediately in accordance with the traffic conditions. Do not continue driving.</li> <li>► Consult a qualified specialist workshop.</li> </ul>

### Driving safety systems

Warning/indicator lamp	Possible causes/consequences and ► Solutions
<div data-bbox="205 487 362 570" style="border: 1px solid black; padding: 5px; display: inline-block;">  </div> <p data-bbox="195 578 380 601">ABS warning lamp</p>	<p data-bbox="504 484 1129 508">The yellow ABS warning lamp is lit while the engine is running.</p> <p data-bbox="504 519 755 542">*ABS is malfunctioning.</p> <p data-bbox="504 553 1134 577">If there is an additional warning tone, EBD is malfunctioning.</p> <p data-bbox="504 587 1304 611">Other driving systems and driving safety systems may also be malfunctioning.</p> <ul style="list-style-type: none"> <li>► Note the messages on the multifunction display.</li> </ul> <div data-bbox="537 666 1698 707" style="background-color: #f0f0f0; padding: 5px;"> <p data-bbox="543 674 1280 698"><b>▲ WARNING</b> There is a risk of skidding if EBD or ABS is malfunctioning</p> </div> <p data-bbox="543 713 912 737">The wheels may lock during braking.</p> <p data-bbox="543 747 1665 798">The steerability and braking characteristics are heavily impaired and the braking distance may increase. In addition, other driving safety systems are switched off.</p> <ul style="list-style-type: none"> <li>► Drive on carefully.</li> <li>► Have the brake system checked immediately at a qualified specialist workshop.</li> </ul>

Warning/indicator lamp	Possible causes/consequences and ► Solutions
 <p>ESP® warning lamp flashes</p>	<p>The yellow ESP® warning lamp flashes while the vehicle is in motion.</p> <p>* One or more wheels has reached its grip limit (→ page 176).</p> <ul style="list-style-type: none"> <li>► Adapt your driving style to suit the road and weather conditions.</li> </ul>
 <p>ESP® warning lamp lights up</p>	<p>The yellow ESP® warning lamp is lit while the engine is running.</p> <p>*ESP® is malfunctioning.</p> <p>Other driving systems and driving safety systems (e.g. BAS) may also be malfunctioning.</p> <ul style="list-style-type: none"> <li>► Note the messages on the multifunction display.</li> </ul> <div style="background-color: #f0f0f0; padding: 5px; border: 1px solid #ccc;"> <p><b>▲ WARNING</b> Risk of skidding if ESP® is malfunctioning</p> <p>If ESP® is malfunctioning, ESP® cannot carry out vehicle stabilization. In addition, other driving safety systems are switched off.</p> <ul style="list-style-type: none"> <li>► Drive on carefully.</li> <li>► Have ESP® checked at a qualified specialist workshop.</li> </ul> </div>
 <p>ESP® OFF warning lamp</p>	<p>The yellow ESP® OFF warning lamp is lit while the engine is running.</p> <p>*ESP® is deactivated.</p> <p>Other driving systems and driving safety systems may also be inoperative.</p>



Warning/indicator lamp	Possible causes/consequences and ► Solutions
	<p data-bbox="545 253 1694 290"><b>▲ WARNING</b> Risk of skidding when driving with ESP® deactivated</p> <p data-bbox="545 300 1694 331">ESP® does not act to stabilize the vehicle. The availability of further driving safety systems is also limited.</p> <ul data-bbox="545 336 1694 404" style="list-style-type: none"> <li data-bbox="545 336 1694 367">► Drive on carefully.</li> <li data-bbox="545 367 1694 404">► Deactivate ESP® only for as long as the situation requires.</li> </ul> <p data-bbox="545 419 1694 450">If ESP® cannot be activated, ESP® is malfunctioning.</p> <ul data-bbox="545 455 1694 492" style="list-style-type: none"> <li data-bbox="545 455 1694 492">► Have ESP® checked immediately at a qualified specialist workshop.</li> </ul> <p data-bbox="526 512 1694 543">► Observe the notes on deactivating ESP® (→ page 176).</p>

### Tire pressure monitor

Warning/indicator lamp	Possible causes/consequences and ► Solutions
 <p data-bbox="194 782 443 854">Tire pressure monitoring system warning lamp flashes</p>	<p data-bbox="508 688 1694 735">The yellow tire pressure monitor warning lamp (pressure loss/malfunction) flashes for approximately one minute and then remains lit.</p> <p data-bbox="517 745 1694 771">*The tire pressure monitor is malfunctioning.</p> <p data-bbox="545 792 1694 828"><b>▲ WARNING</b> There is a risk of an accident if the tire pressure monitoring system is malfunctioning</p> <p data-bbox="545 833 1694 865">The tire pressure monitoring system cannot issue a warning if there is pressure loss in one or more of the tires.</p>

## 430 Display messages and warning/indicator lamps

Warning/indicator lamp	Possible causes/consequences and ► Solutions
	<p>Tires with insufficient tire pressure may impair the driving characteristics as well as steering and braking.</p> <p>► Have the tire pressure monitoring system checked at a qualified specialist workshop.</p>
 <p>Tire pressure monitoring system warning lamp lights up</p>	<p>The yellow tire pressure monitoring system warning lamp (pressure loss/malfunction) is lit.</p> <p>*The tire pressure monitoring system has detected tire pressure loss in at least one of the tires.</p> <p><b>▲ WARNING</b> Risk of an accident due to insufficient tire pressure</p> <ul style="list-style-type: none"><li>• The tires can burst.</li><li>• The tires can wear excessively and/or unevenly.</li><li>• The driving characteristics as well as the steering and braking may be greatly impaired.</li></ul> <p>You could then lose control of the vehicle.</p> <p>► Observe the recommended tire pressures.</p> <p>► Adjust the tire pressure if necessary.</p> <p>► Stop the vehicle in accordance with the traffic conditions.</p> <p>► Check the tire pressure and the tires.</p>

## 1, 2, 3 ...

<b>4MATIC</b> .....	164
Function .....	164
<b>12 V battery</b>	
see Battery (vehicle)	
<b>12 V socket</b>	
see Socket (12 V)	
<b>48 V on-board electrical system</b>	
Operating safety .....	25
<b>115 V socket</b>	
see Socket (115 V)	
<b>360° Camera</b> .....	219
Function .....	219
Opening the camera cover (rear view camera) .....	223
Selecting a view .....	222

## A

**A/C function**

Activating/deactivating (MBUX multimedia system) .....	136
Switching on/off (control panel) .....	136

<b>ABS (Anti-lock Braking System)</b> .....	175
---------------------------------------------	-----

**Acceleration**

    see Kickdown

**Accident and breakdown management**

Mercedes me connect .....	270
---------------------------	-----

**Acoustic locking verification signal**

Activating/deactivating .....	66
-------------------------------	----

**Active Blind Spot Assist**

Activating/deactivating .....	230
Brake application .....	233
Function .....	232
System limitations .....	230
Trailer operation .....	230
Trailer operation .....	232

**Active Brake Assist**

Function/notes .....	180
Setting .....	184

**Active Distance Assist DISTRONIC**

Active Emergency Stop Assist .....	188
Active Lane Change Assist .....	198
Active Lane Change Assist .....	197
Calling up a speed .....	191
Function .....	188
Increasing/decreasing speed .....	191
Requirements .....	191
Route-based speed adaptation .....	193

Steering wheel buttons .....	191
Storing a speed .....	191
Switching off/deactivating .....	191
Switching on/activating .....	191
System limitations .....	188

**Active Emergency Stop Assist**

.....	198
-------	-----

**Active Lane Change Assist**

Activating/deactivating .....	197
Function .....	197

**Active Lane Keeping Assist**

.....	233
Activating/deactivating .....	235
Activating/deactivating the warning ...	235
Function .....	233
Setting the sensitivity .....	235
System limits .....	233
Trailer operation .....	233

**Active Parking Assist**

.....	223
Exiting a parking space .....	226
Function .....	223
Parking .....	224
System limitations .....	223

**Active Service System PLUS**

    see ASSYST PLUS

- Active Speed Limit Assist** ..... 193  
 Display ..... 193  
 Function ..... 193
- Active Steering Assist** ..... 195  
 Activating/deactivating ..... 197  
 Active Emergency Stop Assist ..... 198  
 Active Lane Change Assist ..... 197  
 Function ..... 195  
 System limits ..... 195
- Active Traffic Jam Assist**  
 Activating/deactivating ..... 200  
 Function ..... 199
- Adaptive cruise control**  
 see Active Distance Assist DISTRONIC
- Adaptive Highbeam Assist**  
 Function ..... 124  
 Switching on/off ..... 125
- Additives** ..... 359  
 Engine oil ..... 359  
 Fuel ..... 359
- Additives (engine oil)**  
 see Additives
- Additives (fuel)**  
 see Fuel
- ADS PLUS damping system**  
 see AIRMATIC
- After-sales service center**  
 see ASSYST PLUS
- Air bag**  
 Reduced protection ..... 44
- Air conditioning menu**  
 Calling up ..... 136
- Air distribution**  
 Setting ..... 135  
 Setting (MBUX multimedia system) ..... 137
- Air freshener system**  
 see Perfume atomizer
- Air inlet**  
 see Air-water duct
- Air pressure**  
 see Tire pressure
- Air suspension**  
 see AIRMATIC
- Air vents** ..... 140  
 Adjusting (front) ..... 140  
 Adjusting (rear) ..... 141  
 Glove box ..... 141
- Air vents**  
 see Air vents
- Air-conditioning system**  
 see Climate control
- Air-recirculation mode** ..... 138
- Air-water duct** ..... 295  
 Keeping free ..... 295
- Airbag** ..... 42  
 Activation ..... 37  
 Front airbag (driver, front passenger) .... 42  
 Installation locations ..... 42  
 Knee airbag ..... 42  
 Overview ..... 42  
 PASSENGER AIR BAG indicator lamp .... 46  
 Protection ..... 43  
 Side airbag ..... 42  
 Window curtain airbag ..... 42
- Airflow**  
 Setting ..... 135
- AIRMATIC** ..... 201  
 Setting ..... 203

- Suspension ..... 201
- Alarm**  
see Panic alarm
- Alarm system**  
see ATA (anti-theft alarm system)
- All-wheel drive**  
see 4MATIC
- Ambient lighting**  
Setting (multimedia system) ..... 127
- Android Auto**  
see Smartphone integration®
- Animals**  
Pets in the vehicle ..... 64
- Anti-lock braking system**  
see ABS (Anti-lock Braking System)
- Anti-skid chains**  
see Snow chains
- Anti-theft protection**  
Immobilizer ..... 84
- Anticipatory occupant protection**  
see PRE-SAFE® (anticipatory occupant protection)
- see PRE-SAFE® PLUS (anticipatory occupant protection plus)
- Apple CarPlay**  
see Smartphone integration®
- Assistance systems**  
see Driving safety system
- ASSYST PLUS** ..... 288  
Battery disconnection periods ..... 289  
Displaying the service due date ..... 288  
Function/notes ..... 288  
Regular maintenance work ..... 288  
Special service requirements ..... 288
- ATA (anti-theft alarm system)** ..... 85  
Activating/deactivating the interior motion sensor ..... 87  
Arming/disarming the tow-away alarm ..... 86  
Deactivating the alarm ..... 85  
Function ..... 85  
Function of the interior motion sensor .. 86  
The tow-away alarm function ..... 86
- ATTENTION ASSIST** ..... 227, 228  
Function ..... 227  
Setting ..... 228
- System limitations ..... 227
- Attention assistant**  
see ATTENTION ASSIST
- Authorized Mercedes-Benz Center**  
see Qualified specialist workshop
- Authorized workshop**  
see Qualified specialist workshop
- Automatic car wash mode**  
Activating ..... 297
- Automatic distance control**  
see Active Distance Assist DISTRONIC
- Automatic driving lights** ..... 122
- Automatic engine start (ECO start/stop function)** ..... 153
- Automatic engine stop (ECO start/stop function)** ..... 153
- Automatic front passenger front air-bag shutoff** ..... 45, 46  
Function of the automatic front passenger front airbag shutoff ..... 45  
PASSENGER AIR BAG indicator lamp ..... 46



















- Automatic front passenger front air-bag shutoff**  
 see Automatic front passenger front airbag shutoff
- Automatic measures after an accident** ... 50
- Automatic mirror folding function**  
 Activating/deactivating ..... 134
- Automatic seat adjustment**  
 Setting ..... 94
- Automatic transmission**  
 DIRECT SELECT lever ..... 160  
 Drive program display ..... 158  
 Drive programs ..... 157  
 DYNAMIC SELECT switch ..... 157  
 Engaging drive position ..... 162  
 Engaging neutral ..... 161  
 Engaging park position ..... 161  
 Engaging reverse gear ..... 161  
 Kickdown ..... 163  
 Manual gearshifting ..... 162  
 Steering wheel paddle shifters ..... 162  
 Transmission position display ..... 160  
 Transmission positions ..... 160
- Axle load**  
 Towing a trailer ..... 367
- B**
- Bag hook** ..... 109
- Baidu CarLife**  
 see Smartphone integration®
- Ball neck**  
 Installing ..... 237
- BAS (Brake Assist System)** ..... 176
- Battery**  
 SmartKey ..... 67
- Battery**  
 see Battery (vehicle)
- Battery (vehicle)** ..... 312  
 Charging ..... 311  
 Charging (Remote Online) ..... 145  
 Notes ..... 307  
 Notes (starting assistance and charging) ..... 309  
 Replacing ..... 312  
 Starting assistance ..... 311
- Belt**  
 see Seat belt
- Blind Spot Assist** ..... 230  
 Activating/deactivating ..... 233  
 Function ..... 230  
 System limitations ..... 230
- Blower**  
 see Climate control
- Brake Assist System**  
 see BAS (Brake Assist System)
- Brake fluid**  
 Notes ..... 360
- Brake force distribution**  
 EBD (electronic brake force distribution) ..... 179
- Brakes**  
 ABS (Anti-lock Braking System) ..... 175  
 Active Brake Assist ..... 180  
 BAS (Brake Assist System) ..... 176  
 Driving tips ..... 148  
 EBD (electronic brake force distribution) ..... 179  
 HOLD function ..... 200















- Limited braking effect (salt-treated roads) ..... 148
- New/replaced brakepads/brake discs ..... 146
- Notes on breaking-in a new vehicle ..... 146
- Post-collision brake ..... 50
- Braking assistance**  
see BAS (Brake Assist System)
- Breakdown**  
Changing a wheel ..... 343
- Overview of the help functions ..... 18
- Roadside Assistance ..... 24
- Tow-starting ..... 317
- Towing away ..... 314
- Transporting the vehicle ..... 315
- Breakdown**  
see Flat tire
- Buttons**  
Steering wheel ..... 243
- C**
- Calls**  
Mercedes me ..... 271
- Camera** ..... 208
- Camera**  
see 360° Camera  
see Rear view camera
- Car key**  
see SmartKey
- Car wash**  
see Care
- Car wash (care)** ..... 295
- Car-to-X-Communication**  
Displaying hazard warnings ..... 265
- Care** ..... 301
- Air-water duct ..... 295
- Automatic car wash ..... 295
- Carpet ..... 301
- Decorative foil ..... 298
- Display ..... 301
- Exterior lighting ..... 299
- Headliner ..... 301
- Paintwork ..... 298
- Plastic trim ..... 301
- Power washer ..... 297
- Real wood/trim elements ..... 301
- Rear view camera ..... 299
- Running boards ..... 299
- Seat belts ..... 301
- Seat cover ..... 301
- Sensors ..... 299
- Surround view camera ..... 299
- Tailpipes ..... 299
- Trailer hitch ..... 299
- Washing by hand ..... 298
- Wheels/rims ..... 299
- Windows ..... 299
- Wiper blades ..... 299
- Cargo compartment floor**  
Locking/unlocking ..... 113
- Opening/closing ..... 112
- Cargo tie-down rings** ..... 109
- Carpet (Care)** ..... 301
- Change of address** ..... 25
- Change of ownership** ..... 25
- Changing a wheel**  
Preparation ..... 343
- Raising the vehicle ..... 344
- Changing a wheel**  
see Emergency spare wheel

- Changing gears** ..... 162  
    Manually ..... 162
- Changing hub caps** ..... 343
- Charging**  
    Battery (vehicle) ..... 311  
    Mobile phone (wireless) ..... 118  
    USB port ..... 117
- Child safety lock**  
    Rear doors ..... 62  
    Rear side windows ..... 64
- Child seat**  
    Attaching (notes) ..... 55  
    Basic instructions ..... 51  
    Front-passenger seat (notes) ..... 61  
    LATCH-type (ISOFIX) (installing) ..... 56  
    Notes on risks and dangers ..... 52  
    Securing on the front passenger seat .... 61  
    Securing on the rear seat ..... 59  
    Top Tether ..... 58
- Children**  
    Avoiding dangers in the vehicle ..... 52  
    Basic instructions ..... 51  
    Special seat belt retractor ..... 55
- Chock** ..... 342  
    Storage location ..... 342
- Chock**  
    see Chock
- Cleaning**  
    see Care
- Climate control** ..... 135  
    Activating/deactivating ..... 136  
    Activating/deactivating (rear operating unit) ..... 136  
    Activating/deactivating the A/C function (control panel) ..... 136  
    Activating/deactivating the A/C function (MBUX multimedia system) ... 136  
    Activating/deactivating the synchronization function (control panel) ..... 137  
    Activating/deactivating the synchronization function (MBUX multimedia system) ..... 138  
    Air-recirculation mode ..... 138  
    Automatic control ..... 137  
    Automatically controlling (rear operating unit) ..... 137  
    Calling up the air conditioning menu ... 136
- Control panel for 3-zone automatic climate control ..... 135  
Control panel for dual-zone automatic climate control ..... 135  
Defrosting the windshield ..... 135  
Filling capacity for PAG oil ..... 363  
Front air vents ..... 140  
Glove box air vent ..... 141  
Inserting/removing the flacon (fragrance system) ..... 139  
Ionization ..... 138  
Note ..... 135  
Rear air vents ..... 141  
Rear operating unit ..... 136  
Refrigerant ..... 362  
Refrigerant filling capacity ..... 363  
Removing condensation from the windows ..... 138  
Residual heat ..... 138  
Residual heat (rear operating unit) ..... 138  
Setting (MBUX multimedia system) .... 136  
Setting the air distribution ..... 135  
Setting the airflow ..... 135  
Setting the fragrance system ..... 139  
Setting the temperature ..... 135



- Switching the rear window heater on/off ..... 135
  - Ventilating the vehicle (convenience opening) ..... 79
  - Windshield heater ..... 140
  - Coat hook** ..... 110
    - Using ..... 110
  - Cockpit** ..... 6
    - Overview ..... 6
  - Coffee cup symbol**
    - see ATTENTION ASSIST
  - Collapsible cargo compartment cover**
    - Notes ..... 107
    - Removing/installing ..... 108
    - Unfolding/folding up ..... 107
  - Collapsible spare wheel** ..... 350
    - Inflating ..... 351
    - Notes ..... 350
    - Removing ..... 351
  - Collision detection (parked vehicle)** ..... 172
  - Combination switch** ..... 122
  - Computer**
    - see On-board computer
  - Consumption indicator**
    - Calling up ..... 160
  - Convenience closing feature** ..... 79
  - Convenience opening** ..... 79
  - Coolant (engine)**
    - Check level ..... 293
    - Filling capacity ..... 361
    - Notes ..... 361
  - Cooling**
    - see Climate control
  - Copyrights**
    - License ..... 34
    - Trademarks ..... 35
  - Cornering light** ..... 124
  - Crosswind Assist**
    - Function/notes ..... 179
  - Cruise control** ..... 185
    - Buttons ..... 185
    - Calling up a speed ..... 185
    - Function ..... 185
    - Requirements: ..... 185
    - Selecting ..... 185
    - Setting a speed ..... 185
  - Storing a speed ..... 185
  - Switching off ..... 185
  - Switching on ..... 185
  - System limitations ..... 185
  - Cup holder**
    - Switching the cooling/heating function on/off ..... 114
  - Customer Assistance Center (CAC)** ..... 29
  - Customer Relations Department** ..... 29
- D**
- Dashboard**
    - see Cockpit
  - Data acquisition**
    - Vehicle ..... 31
  - Data storage**
    - Electronic control units ..... 31
    - Online services ..... 33
    - Vehicle ..... 31
  - Daytime running lamp mode**
    - see Daytime running lights
  - Daytime running lights** ..... 125
    - Switching on/off ..... 125

- Deactivating the alarm (ATA)** ..... 85
- Dealership**  
see Qualified specialist workshop
- Declaration of conformity**  
Wireless vehicle components ..... 27
- Decorative foil (cleaning instructions)**  
..... 298
- Definitions (tires and loading)** ..... 336
- Destination entry** ..... 262  
Entering a POI or address ..... 262
- Detecting inattentiveness**  
see ATTENTION ASSIST
- Diagnostics connection** ..... 27
- Digital Operator's Manual** ..... 20
- Dinghy towing**  
see Tow-bar system
- DIRECT SELECT lever** ..... 160  
Engaging drive position ..... 162  
Engaging neutral ..... 161  
Engaging park position ..... 161  
Engaging park position automatically ... 161  
Engaging reverse gear ..... 161
- Function ..... 160
- Display (Care)** ..... 301
- Display (MBUX multimedia system)**  
Home screen ..... 249
- Display (multimedia system)** ..... 250  
Operating ..... 250
- Display (on-board computer)**  
Displays on the multifunction display .. 245
- Display message** ..... 368  
Calling up (on-board computer) ..... 368  
Notes ..... 368
- Display messages**
-  --- mph ..... 403
  -  --- mph ..... 401
  -  12 V Battery See Operator's Manual ..... 409
  -  48 V Battery See Operator's Manual ..... 410
  -  Active Headlamps Inoperative .... 375
  -  ATTENTION ASSIST Inoperative ..... 390
-  ATTENTION ASSIST: Take a Break! ..... 390
-  Automatic Headlamp Mode Inoperative ..... 374
-  Check Brake Fluid Level ..... 389
-  Check Brake Pads See Operator's Manual ..... 390
-  Check Coolant Level See Operator's Manual ..... 380
-  Check Engine Oil Level (Add 1 quart) ..... 415
-  Check Left Low Beam (example) ..... 374
-  Check Tires ..... 413
-  Check Washer Fluid ..... 379
-  Compressor Is Cooling ..... 394
-  Coolant Too Hot Stop Vehicle Turn Engine Off ..... 380
-  Currently Unavailable Camera View Restricted ..... 400

- |                                                                                                                                               |                                                                                                                                                           |                                                                                                                                                                    |
|-----------------------------------------------------------------------------------------------------------------------------------------------|-----------------------------------------------------------------------------------------------------------------------------------------------------------|--------------------------------------------------------------------------------------------------------------------------------------------------------------------|
|  Currently Unavailable Radar Sensors Dirty ..... 399         |  Inoperative See Operator's Manual ..... 405                             |  Max. Speed 25 mph ..... 401                                                    |
|  Currently Unavailable See Operator's Manual ..... 404       |  Inoperative See Operator's Manual ..... 406                             |  Not in Curr. Drive Prog. .... 401                                              |
|  Currently Unavailable See Operator's Manual ..... 405       |  EBD Inoperative See Operator's Manual ..... 407                         |  Obtain a New Key ..... 372                                                     |
|  Don't Forget Your Key ..... 373                             |  Inoperative ..... 408                                                   |  Off ..... 402                                                                  |
|  Drive More Slowly ..... 394                                 |  Inoperative ..... 401                                                   |  HOLD Off ..... 400                                                             |
|  Engine Oil Level Cannot Be Measured ..... 417               |  Intell. Light System Inoperative .. 375                                 |  PARK Parking Brake See Operator's Manual ..... 385                             |
|  Engine Oil Level Low Stop Vehicle Turn Engine Off ..... 416 |  Key Not Detected (red display message) ..... 373                        |  Please Correct Tire Pressure ..... 413                                         |
|  Engine Oil Pressure Stop Switch Off Engine ..... 417        |  Key Not Detected (white display message) ..... 372                      |  PARK Please Release Parking Brake .... 388                                     |
|  Engine Oil Reduce Oil Level ..... 416                       |  Left Side Curtain Airbag Malfunction Service Required (example) ... 369 |  Please Wait Charging 48 V Battery... ..... 411                                 |
|  Front Left Malfunction Service Required (example) ..... 369 |  Lowering ..... 392                                                      |  Replace Key Battery ..... 372                                                  |
|  Fuel Level Low ..... 381                                    |  Malfunction Drive at Max. 50 mph ..... 391, 392                         |  See Operator's Manual ..... 409                                                |
|  Gas Cap Loose ..... 381                                     |  Malfunction See Operator's Manual ..... 374                             |  SRS Malfunction Service Required ..... 369                                     |
|                                                                                                                                               |                                                                                                                                                           |  Steering Malfunction Increased Physical Effort See Operator's Manual ..... 377 |
|                                                                                                                                               |                                                                                                                                                           |  Steering Malfunction Stop Immediately See Operator's Manual .... 377           |

-  Stop Vehicle Leave Engine Running ..... 410
-  Stop Vehicle See Operator's Manual ..... 410
-  Suspended ..... 402
-  Switch Off Lights ..... 375
-  Switch On Headlamps ..... 375
- PARK** Turn On the Ignition to Release the Parking Brake ..... 389
-  Vehicle Ready to Drive Switch the Ignition Off Before Exiting ..... 377
-  Vehicle Rising Please Wait ..... 394
-  Vehicle Rising ..... 392
-  Warning Tire Malfunction ..... 414
-  Wheel Sensor(s) Missing ..... 412
- Active Blind Spot Assist Currently Unavailable See Operator's Manual ..... 397
- Active Blind Spot Assist Inoperative .... 397
- Active Blind Spot Asst. Not Available When Towing a Trailer See Operator's Manual ..... 398
- Active Brake Assist Functions Currently Limited See Operator's Manual ..... 407
- Active Brake Assist Functions Limited See Operator's Manual ..... 408
- Active Distance Assist Currently Unavailable See Operator's Manual ..... 402
- Active Distance Assist Inoperative ..... 402
- Active Distance Assist Now Available ..... 402
- Active Lane Keeping Assist Currently Unavailable See Operator's Manual ..... 396
- Active Lane Keeping Assist Inoperative ..... 396
- Active Parking Assist and PARKTRONIC Inoperative See Operator's Manual ..... 398
- Active Steering Assist Currently Unavailable See Operator's Manual ..... 394
- Active Steering Assist Inoperative ..... 395
- Active Steering Asst. Currently Unavailable Due to Multiple Emergency Stops ..... 395
- Active Stop & Go Assist Currently Unavailable See Operator's Manual ..... 396
- Active Stop & Go Assist Inoperative See Operator's Manual ..... 396
- Adaptive Highbeam Assist Currently Unavailable See Operator's Manual ..... 376
- Adaptive Highbeam Assist Inoperative ..... 376
- Apply Brake to Shift from 'P' ..... 382
- Apply Brake to Shift to 'R' ..... 382
- Apply Brake to Shift to D or R ..... 382
- Auxiliary Battery Malfunction ..... 384
- Beginning Emergency Stop ..... 395

- Blind Spot Assist Currently Unavailable See Operator's Manual ..... 396
- Blind Spot Assist Inoperative ..... 397
- Blind Spot Assist Not Available When Towing a Trailer See Operator's Manual ..... 397
- Cannot Start Engine See Operator's Manual ..... 411
- Cruise Control Inoperative ..... 403
- Cruise Control Off ..... 403
- Decrease Speed ..... 415
- Driver's Door Open & Transmission Not in P Risk of Vehicle Rolling Away .. 382
- Engine Can Now Be Started ..... 411
- Front Passenger Airbag Disabled See Operator's Manual ..... 370
- Front Passenger Airbag Enabled See Operator's Manual ..... 370
- Hazard Warning Flashers Malfunctioning ..... 376
- Mercedes me connect Services Limited See Operator's Manual ..... 408
- N Permanently Active Risk of Rolling Away ..... 383
- Only Shift to 'P' when Vehicle is Stationary ..... 381
- Place the Key in the Marked Space See Operator's Manual ..... 373
- PRE-SAFE Impulse Side Inoperative See Operator's Manual ..... 371
- PRE-SAFE Inoperative See Operator's Manual ..... 371
- Reversing Not Possible Service Required ..... 383
- Service Required Do Not Shift Gears Visit Dealer ..... 383
- Stop Vehicle Leave Engine Running Wait Transmission Cooling ..... 384
- Tire Press. Monitor Currently Unavailable ..... 412
- Tire Press. Monitor Inoperative ..... 412
- Tire Pressure Monitor Inoperative No Wheel Sensors ..... 412
- Tires Overheated ..... 414
- To Deselect P or N, Depress Brake and Start Engine ..... 382
- To switch engine off, press and hold Start/Stop button for at least 3 seconds or press 3 times. .... 379
- Traffic Sign Assist Currently Unavailable See Operator's Manual ..... 398
- Traffic Sign Assist Inoperative ..... 398
- Transmission Malfunction Stop ..... 383
- Update Failed ..... 376
- Update Failed Software Remains Unchanged ..... 376
- Update Successfully Completed ..... 376
- Display on the windshield**  
see Head-up Display
- Distance control**  
see Active Distance Assist DISTRONIC

**DISTRONIC**

see Active Distance Assist DISTRONIC

**Door**

Child safety lock (rear doors) ..... 62  
 Locking (emergency key) ..... 71  
 Opening (from the inside) ..... 68  
 Power closing function ..... 71  
 Unlocking (emergency key) ..... 71  
 Unlocking (from the inside) ..... 68

**Door control panel** ..... 14

**Door control panel (rear passenger compartment)** ..... 16

**DOT, Tire Identification Number (TIN)** ... 332

**Downhill driving assistance**

see DSR

**Drawbar**

see Tow-bar system

**Drinking and driving** ..... 148

**Drive position**

Inserting ..... 162

**Drive program display** ..... 158

**Drive programs**

see DYNAMIC SELECT

**Driver's seat**

see Seat

**Driving safety system** ..... 174

ABS (Anti-lock Braking System) ..... 175  
 Active Brake Assist ..... 180  
 BAS (Brake Assist System) ..... 176  
 Cameras ..... 174  
 EBD (electronic brake force distribution) ..... 179  
 ESP® Crosswind Assist ..... 179  
 ESP® trailer stabilization ..... 179  
 Off-road ABS ..... 176  
 Overview ..... 175  
 Radar and ultrasonic sensors ..... 174  
 Responsibility ..... 174  
 STEER CONTROL ..... 179

**Driving system**

see 360° Camera  
 see Active Blind Spot Assist  
 see Active Distance Assist DISTRONIC  
 see Active Emergency Stop Assist  
 see Active Lane Change Assist

see Active Lane Keeping Assist

see Active Parking Assist

see Active Speed Limit Assist

see Active Steering Assist

see AIRMATIC

see ATTENTION ASSIST

see Blind Spot Assist

see Cruise control

see Driving safety system

see DSR

see E-ACTIVE BODY CONTROL

see HOLD function

see Parking Assist PARKTRONIC

see Rear view camera

see Traffic Sign Assist

**Driving tips**

Drinking and driving ..... 148  
 General driving tips ..... 148  
 Notes on breaking-in a new vehicle .... 146

**Drowsiness detection**

see ATTENTION ASSIST

**DSR** ..... 186

Activating/deactivating ..... 188

Changing the target speed ..... 188

Function ..... 186

- Notes ..... 187
  - Switching on/off ..... 187
  - Dynamic handling control system**  
see ESP® (Electronic Stability Program)
  - DYNAMIC SELECT** ..... 157
    - Configuring drive program I ..... 159
    - Displaying engine data ..... 159
    - Displaying vehicle data ..... 159
    - Drive program display ..... 158
    - Drive programs ..... 157
    - Function ..... 157
    - Operating (DYNAMIC SELECT switch)  
..... 158
    - Selecting the drive program ..... 158
- E**
- E-ACTIVE BODY CONTROL** ..... 206
    - Individual wheel control ..... 209
    - Recovery mode ..... 208
    - Setting the level ..... 209
    - Suspension ..... 206
  - E10** ..... 358
  - Easy entry feature**  
Function/notes ..... 99
  - Easy exit feature**  
Function/notes ..... 99
  - EASY-PACK load-securing kit** ..... 110
    - Installing/removing the telescopic  
rod ..... 111
    - Notes ..... 110
  - EBD (electronic brake force distribu-  
tion)**  
Function/notes ..... 179
  - ECO Assist**  
Function/notes ..... 156
  - ECO display**  
Function ..... 155
  - ECO start/stop function** ..... 153
    - Automatic engine start ..... 153
    - Automatic engine stop ..... 153
    - Method of operation ..... 153
    - Switching off/on ..... 155
  - Electric parking brake** ..... 170
    - Applying automatically ..... 170
    - Applying or releasing manually ..... 172
    - Emergency braking ..... 172
    - Releasing automatically ..... 171
  - Electrohydraulic suspension**  
see E-ACTIVE BODY CONTROL
  - Electronic Stability Program**  
see ESP® (Electronic Stability Program)
  - Emergency**  
Overview of the help functions ..... 18
  - Emergency braking** ..... 172
  - Emergency braking**  
see BAS (Brake Assist System)
  - Emergency call system**  
see Mercedes-Benz emergency call system
  - Emergency engine start** ..... 317
  - Emergency key**  
Locking a door ..... 71  
Unlocking a door ..... 71
  - Emergency operation mode**  
Starting the vehicle ..... 144
  - Emergency spare wheel** ..... 348
    - Inflating ..... 349
    - Notes ..... 348
  - Emergency Tensioning Devices**  
Activation ..... 37

- Engine**  
 ECO start/stop function ..... 153  
 Engine number ..... 355  
 Starting (emergency operation mode) ..... 144  
 Starting (Remote Online) ..... 146  
 Starting (start/stop button) ..... 144  
 Starting assistance ..... 311  
 Switching off (start/stop button) ..... 167
- Engine data**  
 Displaying ..... 159
- Engine number** ..... 355
- Engine oil** ..... 292  
 Additives ..... 359  
 Capacity ..... 360  
 Checking the oil level using the on-board computer ..... 291  
 MB-Freigabe or MB-Approval ..... 360  
 Quality ..... 360  
 Topping up ..... 292
- Entering/exiting level**  
 Setting ..... 204
- EQ boost**  
 Operating safety ..... 25
- ESC (Electronic Stability Control)**  
 see ESP® (Electronic Stability Program)
- ESP®**  
 Crosswind Assist ..... 179  
 Trailer stabilization ..... 179
- ESP® (Electronic Stability Program)** ..... 176  
 Activating/deactivating ..... 178  
 Function/notes ..... 176
- Exterior lighting**  
 see Lights
- Exterior lighting (Care)** ..... 299
- Exterior mirrors** ..... 131, 132  
 Anti-glare mode (automatic) ..... 132  
 Automatic mirror folding function ..... 134  
 Folding in/out ..... 131  
 Operating the memory function ..... 101  
 Parking position ..... 133  
 Setting ..... 131
- F**
- Fatigue detection**  
 see ATTENTION ASSIST
- Flacon**  
 Inserting/removing ..... 139
- Flat tire** ..... 303  
 Changing a wheel ..... 343  
 Notes ..... 303  
 TIREFIT kit ..... 303
- Flat towing**  
 see Tow-bar system
- Floor mats** ..... 119
- Foil covering**  
 Radar and ultrasonic sensors ..... 174
- Fragrance**  
 see Perfume atomizer
- Free driving mode**  
 Starting ..... 211
- Free software** ..... 34
- Frequencies**  
 Two-way radio ..... 354
- Front airbag (driver, front passenger)** ..... 42
- Front passenger seat** ..... 90  
 Adjusting from the driver's seat ..... 90



- Front passenger seat**  
see Seat
- Fuel** ..... 359  
Additives ..... 359  
E10 ..... 358  
Fuel reserve ..... 359  
Gasoline ..... 358  
Quality (gasoline) ..... 358  
Refueling ..... 164  
Sulfur content ..... 358  
Tank content ..... 359
- Function seat**  
see Door control panel
- Function seat (rear passenger compartment)**  
see Seat (rear passenger compartment)
- Fuses** ..... 317  
Before replacing a fuse ..... 317  
Dashboard fuse box ..... 319  
Fuse assignment diagram ..... 317  
Fuse box in the cargo compartment .... 319  
Fuse box in the engine compartment ... 318  
Fuse box in the front-passenger footwell ..... 319
- Notes ..... 317
- Fuses**  
see Fuses
- G**
- Garage door opener**  
Clearing the memory ..... 170  
Opening or closing the door ..... 170  
Programming buttons ..... 168  
Resolving problems ..... 170  
Synchronizing the rolling code ..... 169
- Gasoline** ..... 358
- Gasoline station prices** ..... 265
- Gearshift recommendation** ..... 163
- Genuine parts** ..... 23
- Glide mode** ..... 163
- Glove box**  
Air vent ..... 141
- H**
- Handbrake**  
see Electric parking brake
- Handling characteristics (unusual)** ..... 320
- HANDS-FREE ACCESS** ..... 75
- Hazard warning lights** ..... 123
- Hazardous substances**  
Information ..... 25
- Head restraint**  
Front (adjusting mechanically) ..... 91  
Front (luxury head restraint) ..... 92  
Rear (installing/removing) ..... 93  
Rear passenger compartment (adjusting) ..... 93
- Head-up Display** ..... 246  
Adjusting display elements (on-board computer) ..... 246  
Adjusting the brightness (on-board computer) ..... 246  
Function ..... 245  
Menu (on-board computer) ..... 246  
Operating the memory function ..... 101  
Setting the position (on-board computer) ..... 246  
Switching on/off ..... 247
- Headlamps**  
see Automatic driving lights

- Headliner (care)** ..... 301
- Heating**  
see Climate control
- High beam**  
Activating/deactivating ..... 122
- High-beam flasher** ..... 122
- High-beam headlamps**  
Adaptive Highbeam Assist ..... 124
- Hill start assist** ..... 200
- HOLD function** ..... 200  
Function/notes ..... 200  
Switching on/off ..... 200
- Home screen (media display)**  
Overview ..... 249
- Hood**  
Opening/closing ..... 289
- I**
- Identification plate**  
Engine ..... 355  
Refrigerant ..... 362  
Vehicle ..... 355
- Ignition**  
Switching on (Start/Stop button) ..... 143
- Ignition key**  
see SmartKey
- Immobilizer** ..... 84
- Indicator lamps**  
see Warning/indicator lamps
- Individual drive program**  
Configuring ..... 159  
Selecting ..... 158
- Inside rearview mirror**  
see Exterior mirrors
- Inspection**  
see ASSYST PLUS
- Instrument cluster**  
Function/notes ..... 241, 242
- Instrument Display**  
Function/notes ..... 242  
Instrument cluster ..... 10  
Warning/indicator lamps ..... 417
- Instrument Display and on-board computer**  
Function/notes ..... 241
- Intelligent Light System**  
Adaptive Highbeam Assist ..... 124  
Cornering light ..... 124
- Interior lighting** ..... 126  
Ambient lighting ..... 127  
Reading light ..... 126  
Setting ..... 126  
Switch-off delay time ..... 127
- Interior motion sensor**  
Activating/deactivating ..... 87  
Function ..... 86
- Internet radio**  
see TuneIn
- Ionization**  
Activating/deactivating (MBUX multimedia system) ..... 138
- iPhone®**  
see Smartphone integration®
- J**
- Jack**  
Storage location ..... 342

- Jump-start connection** ..... 311  
 General notes ..... 309
- K**
- KEYLESS-GO**  
 Locking the vehicle ..... 69  
 Problem ..... 70  
 Unlocking setting ..... 66  
 Unlocking the vehicle ..... 69
- Kickdown** ..... 163  
 Using ..... 163
- Knee airbag** ..... 42
- L**
- Labeling (tires)**  
 see Tire labeling
- Lamp**  
 see Interior lighting
- Lamps (Instrument Display)**  
 see Warning/indicator lamps
- Lane detection (automatic)**  
 see Active Lane Keeping Assist
- Lane Keeping Assist**  
 see Active Lane Keeping Assist
- LATCH-type (ISOFIX) child seat securing system**  
 Installing ..... 56
- Level control system**  
 see AIRMATIC  
 see E-ACTIVE BODY CONTROL
- Light switch**  
 Overview ..... 121
- Lighting**  
 see Interior lighting  
 see Lights
- Lights** ..... 121  
 Adaptive Highbeam Assist ..... 124  
 Automatic driving lights ..... 122  
 Combination switch ..... 122  
 Cornering light ..... 124  
 Hazard warning lights ..... 123  
 High beam ..... 122  
 High-beam flasher ..... 122  
 Light switch ..... 121  
 Low-beam headlamps ..... 121  
 Parking lights ..... 121
- Rear fog lamp ..... 121  
 Responsibility for lighting systems ..... 121  
 Setting the exterior lighting switch-off delay time ..... 125  
 Standing lights ..... 121  
 Switching the surround lighting on/off ..... 126  
 Turn signal light ..... 122
- Limited Warranty**  
 Vehicle ..... 31
- Limiting the opening angle (tailgate)** ..... 77
- Live Traffic Information**  
 Switching the traffic information display on ..... 265
- Load index (tires)** ..... 334
- Load-bearing capacity (tires)** ..... 334
- Loading** ..... 109  
 Bag hook ..... 109  
 Cargo tie-down rings ..... 109  
 Coat hook ..... 110  
 Definitions ..... 336  
 Notes ..... 102  
 Roof luggage rack ..... 113

- Stowage space underneath the cargo compartment floor ..... 112
- Loading**  
see EASY-PACK load-securing kit
- Loading guidelines** ..... 102
- Loading information table** ..... 326
- Loads**  
  Securing ..... 102
- Locking/unlocking**  
  Activating/deactivating the automatic locking feature ..... 70  
  Emergency key ..... 71  
  KEYLESS-GO ..... 69  
  Opening the tailgate ..... 72  
  Unlocking and opening doors from the inside ..... 68
- Low-beam headlamps**  
  Switching on/off ..... 121
- Lowering the vehicle**  
  Rear of the vehicle ..... 205
- Lubricant additives**  
  see Additives
- Luggage**  
  Securing ..... 102
- Lumbar support**  
  see Lumbar support (4-way)
- Lumbar support (4-way)** ..... 91
- M**
- MAGIC VISION CONTROL**  
  Windshield wipers ..... 130
- Maintenance**  
  Vehicle ..... 24
- Maintenance**  
  see ASSYST PLUS
- Malfunction**  
  Restraint system ..... 37
- Malfunction message**  
  see Display message
- Map** ..... 264  
  Displaying online map contents ..... 265  
  Displaying weather information ..... 265  
  Moving ..... 264  
  Selecting the map orientation ..... 264  
  Setting the map scale ..... 264
- Switching freeway information on/off ..... 264
- Massage program**  
  Overview ..... 95  
  Resetting the settings ..... 96
- Massage programs**  
  Selecting the front seats ..... 95
- Massage settings**  
  Resetting ..... 96
- Maximum load rating** ..... 333
- Maximum permissible load**  
  Calculation example ..... 328  
  Determining ..... 327
- Maximum speeds** ..... 364
- Maximum tire pressure** ..... 333
- MBUX Interior Assistant**  
  Switching the reading light for the driver and front passenger on/off contact-free ..... 253  
  Switching the search light for the driver on/off ..... 253

- MBUX Interior Assistant (multimedia system)** ..... 252  
 Overview ..... 252
- MBUX multimedia system** ..... 248  
 Activating/deactivating standby mode ..... 173  
 Configuring drive program I ..... 159  
 Notes ..... 248  
 Overview ..... 248  
 Setting route-based speed adaptation ..... 194  
 Setting the rear climate control ..... 137  
 Standby mode function ..... 173
- Mechanical key**  
 Inserting/removing ..... 67  
 Unlocking the tailgate ..... 77
- Media**  
 Overview of the functions and symbols ..... 280
- Media mode**  
 Connecting Bluetooth® audio equipment ..... 281
- Medical aids** ..... 29
- Memory function**  
 Head-up Display – Calling up stored settings ..... 101  
 Head-up Display – Storing settings ..... 101  
 Operating ..... 101  
 Outside mirrors – Calling up stored settings ..... 101  
 Outside mirrors – Storing settings ..... 101  
 Seat – Calling up stored settings ..... 101  
 Seat – Storing settings ..... 101
- Menu (on-board computer)**  
 Head-up Display ..... 246  
 Overview ..... 243
- Mercedes me app**  
 Information ..... 274
- Mercedes me calls**  
 Arranging a service appointment ..... 273  
 Calling the Mercedes-Benz Customer Center ..... 272  
 Calling the Mercedes-Benz Customer Center after automatic accident or breakdown detection ..... 272  
 Concierge Service ..... 271  
 Information ..... 271
- Making a call via the overhead control panel ..... 271  
 Transferred data ..... 273
- Mercedes me connect**  
 Accident and breakdown management ..... 270  
 Information ..... 269  
 Transferred data ..... 271
- Mercedes-AMG vehicles**  
 Notes ..... 143
- Mercedes-Benz emergency call system** ..... 276  
 Automatic emergency call ..... 277  
 Information ..... 276  
 Information on data transfer ..... 279  
 Manual emergency call ..... 278  
 Overview ..... 277
- Mercedes-Benz Link**  
 see Smartphone integration®
- Message (multifunction display)**  
 see Display message
- Message memory** ..... 368

**Mirrors**

see Exterior mirrors

**Mobile phone**

Wireless charging ..... 119

**Mobile phone**

see Smartphone integration®

see Telephone

**Model series**

see Vehicle identification plate

**Multifunction camera**

ROAD SURFACE SCAN ..... 208

**Multifunction display**

Overview of the displays ..... 245

**Multifunction steering wheel**

Overview of buttons ..... 243

**Multifunction steering wheel**

see Steering wheel

**Multimedia system**

Activating/deactivating DSR ..... 188

Collision detection (parked vehicle) ..... 172

**Multimedia system**

see Display (multimedia system)

see MBUX Interior Assistant (multi-media system)

see MBUX multimedia system

see Touchpad

**N****Navigation**

Notes ..... 259

Overview ..... 261

Showing/hiding the menu ..... 260

Switching on ..... 260

**Navigation**

see Destination entry

see Map

see Route

**Neutral**

Inserting ..... 161

**Notes** ..... 147

Optimized acceleration ..... 147

**Notes on breaking-in a new vehicle** ..... 146

**O****Occupant safety**

see Airbag

see Automatic front passenger front airbag shutoff

see Automatic measures after an accident

see Pets in the vehicle

see Post-collision brake

see PRE-SAFE® (anticipatory occupant protection)

see PRE-SAFE® Impulse Side

see PRE-SAFE® PLUS (anticipatory occupant protection plus)

see Restraint system

see Seat belt

**Off-road Assist**

Setting ..... 211

**Off-road driving** ..... 151

**Off-road driving**

see Off-road driving

**Off-road ESP® (Electronic Stability Program)**

Switching on/off ..... 178

**Oil**

see Engine oil

- On-board computer** ..... 243
    - Displaying the service due date ..... 288
    - Head-up Display menu ..... 246
    - Multifunction display ..... 245
    - Operating ..... 243
    - Overview of menus ..... 243
  - On-board diagnostics interface**
    - see Diagnostics connection
  - Online services**
    - Data storage ..... 33
  - Open-source software** ..... 34
  - Opening the tailgate using your foot**
    - HANDS-FREE ACCESS ..... 75
  - Operating fluids**
    - Additives (fuel) ..... 359
    - Brake fluid ..... 360
    - Coolant (engine) ..... 361
    - Engine oil ..... 359
    - Fuel (gasoline) ..... 358
    - Notes ..... 357
    - Refrigerant (air conditioning system) ... 362
    - Windshield washer fluid ..... 362
  - Operating safety**
    - 48 V on-board electrical system ..... 25
  - Declaration of conformity (wireless vehicle components) ..... 27
  - EQ boost ..... 25
  - Information ..... 25
  - Operating system**
    - see On-board computer
  - Operator's Manual**
    - Vehicle equipment ..... 23
  - Operator's Manual (digital)** ..... 20
  - Optimized acceleration** ..... 147
    - Activating ..... 147
  - Overhead control panel**
    - Overview ..... 12
- P**
- Paint code** ..... 355
  - Paintwork (cleaning instructions)** ..... 298
  - Panel heating**
    - Setting ..... 97
  - Panic alarm** ..... 66
    - Activating/deactivating ..... 66
  - Panorama roof with power tilt/sliding panel**
    - see Sliding sunroof
  - Park position**
    - Inserting ..... 161
    - Selecting automatically ..... 161
  - Parking**
    - see Electric parking brake
  - Parking aid**
    - see Parking Assist PARKTRONIC
  - Parking Assist PARKTRONIC** ..... 212
    - Activating ..... 215
    - Adjusting warning tones ..... 216
    - Function ..... 212
    - Side impact protection ..... 214
    - Switching off ..... 215
    - System limitations ..... 212
  - Parking assistance systems**
    - see Active Parking Assist
  - Parking brake**
    - see Electric parking brake
  - Parking for an extended period** ..... 173
  - Parking lights** ..... 121

- Parking position**  
 Exterior mirrors ..... 133  
 Storing the position of the front-passenger outside mirror using reverse gear ..... 133
- PASSENGER AIR BAG status display**  
 see Automatic front passenger front airbag shutoff
- Payload**  
 Calculation example ..... 328  
 Determining the maximum ..... 327
- Perfume**  
 see Perfume atomizer
- Perfume atomizer** ..... 139  
 Inserting/removing the flacon ..... 139  
 Setting ..... 139
- Perfume vial**  
 see Perfume atomizer
- Period out of use**  
 Activating/deactivating standby mode ..... 173  
 Standby mode function ..... 173
- Permitted towing methods** ..... 313
- Pets in the vehicle** ..... 64
- Plastic trim (Care)** ..... 301
- Post-collision brake** ..... 50
- Power closing function**  
 Door ..... 71
- Power supply**  
 Switching on (Start/Stop button) ..... 143
- Power washer (care)** ..... 297
- Power windows**  
 see Side windows
- PRE-SAFE® (anticipatory occupant protection)** ..... 49  
 Function ..... 49  
 PRE-SAFE® Sound ..... 49  
 Reversing measures ..... 49
- PRE-SAFE® Impulse Side** ..... 50  
 Activation ..... 37  
 Function ..... 50
- PRE-SAFE® PLUS (anticipatory occupant protection plus)** ..... 50  
 Function ..... 50  
 Reversing measures ..... 49
- Preventative occupant protection system**  
 see PRE-SAFE® (anticipatory occupant protection)
- Profile** ..... 254  
 Creating a new profile ..... 255  
 Notes ..... 254  
 Selecting profile options ..... 255
- Programs**  
 see DYNAMIC SELECT
- Protecting the environment**  
 Notes ..... 22
- Pulling away**  
 see Notes
- Q**
- QR code**  
 Rescue card ..... 31
- Qualified specialist workshop** ..... 28
- R**
- Radar and ultrasonic sensors**  
 Damage ..... 174



- Radio**  
 Overview of the functions and symbols ..... 282
- Radio operating permits** ..... 355
- Rain-closing feature**  
 Sliding sunroof ..... 83
- Raising the vehicle**  
 Rear of the vehicle ..... 205
- Reading light**  
 Switching on/off with hand movements ..... 253
- Reading light**  
 see Interior lighting
- Real wood (Care)** ..... 301
- Rear climate control**  
 Setting (MBUX multimedia system) ..... 137
- Rear doors (child safety lock)** ..... 62
- Rear fog lamp**  
 Switching on/off ..... 122
- Rear of the vehicle**  
 Lowering ..... 205  
 Raising ..... 205
- Rear seat**  
 see Seat
- Rear view camera** ..... 216  
 Care ..... 299  
 Function ..... 216  
 Opening the camera cover (360° Camera) ..... 223
- Rear window heater** ..... 135
- Refrigerant (air conditioning system)**  
 Notes ..... 362
- Refueling**  
 Refueling the vehicle ..... 164
- Remote Online**  
 Charging the starter battery ..... 145  
 Cooling or heating the vehicle interior ..... 145  
 Starting the vehicle ..... 146
- Reporting safety defects** ..... 30
- Rescue card** ..... 31
- Reserve**  
 Fuel ..... 359
- Residual heat** ..... 138  
 Rear operating unit ..... 138
- Restraint system** ..... 36  
 Basic instructions for children ..... 51  
 Function in an accident ..... 37  
 Functionality ..... 36  
 Malfunction ..... 37  
 Protection ..... 36  
 Reduced protection ..... 36  
 Self-test ..... 36  
 Warning lamp ..... 36
- Reverse gear**  
 Inserting ..... 161
- Rims (Care)** ..... 299
- ROAD SURFACE SCAN**  
 Multifunction camera ..... 208
- ROAD SURFACE SCAN**  
 see Camera
- Roadside Assistance (breakdown)** ..... 24
- Roll away protection**  
 see HOLD function
- Roller sunblind**  
 Panorama roof with power tilt/sliding panel ..... 80
- Rollover crash** ..... 29

- Roof load** ..... 364
- Roof load display**  
Information ..... 158
- Roof luggage rack**  
Loading ..... 113  
Securing ..... 113
- Route** ..... 263  
Calculating ..... 263  
Selecting options ..... 263
- Route guidance with augmented reality**  
Activating ..... 263  
Displaying street names and house numbers ..... 263
- Route-based speed adaptation**  
Function ..... 193  
Setting ..... 194
- Running boards (Care)** ..... 299
- S**
- Safety systems**  
see Driving safety system
- Satellite radio**  
Logging in ..... 286  
Setting music and sport alerts ..... 286
- Search light**  
Switching on/off with hand movements ..... 253
- Seat** ..... 88, 104  
4-way lumbar support ..... 91  
Adjusting (electrically) ..... 88  
Automatic seat adjustment ..... 94  
Configuring the settings ..... 93  
Correct driver's seat position ..... 88  
Folding the backrest (rear passenger compartment) back ..... 106  
Folding the backrest (rear) forwards .... 104  
Massage program overview ..... 95  
Operating the memory function ..... 101  
Panel heating ..... 97  
Resetting the settings ..... 96  
Setting options ..... 14  
Workout program overview ..... 95
- Seat**  
see Front passenger seat
- Seat (rear passenger compartment)** ..... 16  
Setting options ..... 16
- Seat belt** ..... 38  
Protection ..... 38
- Seat belt adjustment**  
Activating/deactivating ..... 41  
Function ..... 41
- Seat belt warning**  
see Seat belts
- Seat belts** ..... 41  
Activating/deactivating seat belt adjustment ..... 41  
Adjusting the height ..... 41  
Care ..... 301  
Fastening ..... 41  
Reduced protection ..... 39  
Releasing ..... 41  
Seat belt adjustment (function) ..... 41  
Warning lamp ..... 41
- Seat cover (Care)** ..... 301
- Seat heating**  
Activating/deactivating ..... 96

- Seat ventilation**
  - Activating/deactivating ..... 97
- Selecting a gear**
  - see Changing gears
- Selector lever**
  - see DIRECT SELECT lever
- Self-test**
  - Automatic front passenger front air-bag shutoff ..... 46
- Sensors (Care)** ..... 299
- Service center**
  - see Qualified specialist workshop
- Service interval display**
  - see ASSYST PLUS
- Setting a speed**
  - see Cruise control
- Setting the map scale**
  - see Map
- Shift paddles**
  - see Steering wheel paddle shifters
- Shifting gears**
  - Gearshift recommendation ..... 163
- Side airbag** ..... 42
- Side impact protection** ..... 214
- Side windows** ..... 77
  - Child safety lock in the rear passenger compartment ..... 64
  - Closing ..... 77
  - Closing using the SmartKey ..... 79
  - Convenience closing feature ..... 79
  - Convenience opening ..... 79
  - Opening ..... 77
  - Opening with the SmartKey ..... 79
  - Problem ..... 80
- Size designation (tires)** ..... 334
- Sliding sunroof** ..... 80
  - Automatic features ..... 83
  - Closing ..... 80
  - Closing using the SmartKey ..... 79
  - Opening ..... 80
  - Opening with the SmartKey ..... 79
  - Problem ..... 84
  - Rain-closing feature ..... 83
- SmartKey** ..... 65
  - Acoustic locking verification signal ..... 66
  - Battery ..... 67
- Energy consumption ..... 66
- Features ..... 65
- Key ring attachment ..... 67
- Mechanical key ..... 67
- Overview ..... 65
- Panic alarm ..... 66
- Problem ..... 68
- Unlocking setting ..... 66
- SmartKey functions**
  - Deactivating ..... 66
- Smartphone**
  - see Smartphone integration®
  - see Telephone
- Smartphone integration®** ..... 276
  - Overview ..... 276
- Snow chains** ..... 321
- Socket (12 V)** ..... 115
  - Front center console ..... 115
- Socket (115 V)** ..... 116
  - Rear passenger compartment ..... 116
- Software update**
  - System updates ..... 257

- Sound**  
 PRE-SAFE® Sound ..... 49  
 Wheels and tires ..... 320
- Sound menu**  
 Functions overview ..... 287
- Spare wheel**  
 see Collapsible spare wheel  
 see Emergency spare wheel
- Special seat belt retractor** ..... 55
- Specialist workshop** ..... 28
- Speed index (tires)** ..... 334
- Sport Utility Vehicle** ..... 29
- Standby mode**  
 Activating/deactivating ..... 173  
 Function ..... 173
- Standing lights** ..... 121
- Start-off assist**  
 see Optimized acceleration
- Start/Stop button**  
 Parking the vehicle ..... 167  
 Starting the vehicle ..... 144
- Switching on the power supply or  
 ignition ..... 143
- Start/stop function**  
 see ECO start/stop function
- Starter battery**  
 Charging (Remote Online) ..... 145
- Starting assistance**  
 see Jump-start connection
- Starting the engine**  
 see Vehicle
- Starting-off aid**  
 see Hill start assist
- STEER CONTROL**  
 Function/notes ..... 179
- Steering wheel** ..... 243  
 Adjusting (electrically) ..... 98  
 Adjusting (manually) ..... 98  
 Buttons ..... 243  
 Steering wheel heater ..... 99
- Steering wheel heater**  
 Switching on/off ..... 99
- Steering wheel paddle shifters** ..... 162
- Storage areas**  
 see Storage compartment
- Storage compartment** ..... 104  
 Armrest ..... 104  
 Center console ..... 104  
 Door ..... 104  
 Glove box ..... 104
- Storage compartments**  
 see Storage compartment
- Storage spaces**  
 USB ports ..... 104
- Stowage areas**  
 see Loading
- Stowage compartments**  
 see Loading
- Stowage space underneath the cargo  
 compartment floor** ..... 112
- Suggestions**  
 Configuring ..... 255
- Sulfur content** ..... 358
- Surround lighting**  
 Switching on/off ..... 126

- Surround View**  
see 360° Camera
- Surround view camera**  
Care ..... 299
- Suspension**  
Individual wheel control (E-ACTIVE BODY CONTROL) ..... 209  
Rocking free mode (E-ACTIVE BODY CONTROL) ..... 208  
Setting the suspension level (AIR-MATIC) ..... 203  
Setting the suspension level (E-ACTIVE BODY CONTROL) ..... 209
- Suspension**  
see AIRMATIC  
see E-ACTIVE BODY CONTROL
- Suspension level (AIRMATIC)**  
Setting ..... 203
- Suspension level (E-ACTIVE BODY CONTROL)**  
Setting ..... 209
- Switch-off delay time**  
Exterior ..... 125  
Interior ..... 127
- Synchronization function**  
Activating/deactivating (MBUX multimedia system) ..... 138  
Switching on/off (control panel) ..... 137
- System settings**  
Overview of the system settings menu ..... 256
- T**
- Tailgate** ..... 72  
Closing ..... 73  
HANDS-FREE ACCESS ..... 75  
Limiting the opening angle ..... 77  
Opening ..... 72  
Opening dimensions ..... 363  
Unlocking (mechanical key) ..... 77
- Tailpipes (Care)** ..... 299
- Tank content**  
Fuel ..... 359  
Reserve (fuel) ..... 359
- Technical data**  
Axle load (trailer operation) ..... 367  
Information ..... 353  
Notes (trailer hitch) ..... 366
- Radio operating permits ..... 355  
Tongue weight ..... 367  
Towing capacity (trailer operation) ..... 366  
Vehicle identification plate ..... 355
- Telephone** ..... 266, 268  
Connecting a mobile phone (Pass-key) ..... 269  
Connecting a mobile phone (Secure Simple Pairing) ..... 269  
Functions in the telephone menu ..... 269  
Notes ..... 266  
Operating modes ..... 268  
Telephone menu overview ..... 268  
Wireless charging (mobile phone) ..... 119
- Telephony operating modes**  
Bluetooth® Telephony ..... 268
- Temperature** ..... 135
- Temperature grade** ..... 331
- Themes**  
Fastening ..... 255
- Through-loading feature**  
see Seat
- TIN (Tire Identification Number)** ..... 332

- Tire and Loading Information placard** ... 326
- Tire characteristics** ..... 334
- Tire inflation compressor**  
see TIREFIT kit
- Tire information table** ..... 326
- Tire labeling** ..... 331
- Characteristics ..... 334
  - DOT, Tire Identification Number (TIN)  
..... 332
  - Load index ..... 334
  - Load-bearing capacity ..... 334
  - Maximum tire load ..... 333
  - Maximum tire pressure ..... 333
  - Overview ..... 331
  - Speed rating ..... 334
  - Temperature grade ..... 331
  - Tire Quality Grading ..... 331
  - Tire size designation ..... 334
  - Traction grade ..... 331
  - Tread wear grade ..... 331
- Tire load (maximum)** ..... 333
- Tire pressure** ..... 323, 324
- Checking (manually) ..... 324
  - Checking (tire pressure monitoring system) ..... 325
  - Maximum ..... 333
  - Notes ..... 321
  - Restarting the tire pressure monitoring system ..... 326
  - Tire pressure monitoring system (function) ..... 324
  - Tire pressure table ..... 323
  - TIREFIT kit ..... 303
- Tire pressure monitor**
- Function ..... 324
  - Restarting ..... 326
- Tire pressure monitoring system**
- Checking the tire pressure ..... 325
  - Checking the tire temperature ..... 325
- Tire pressure table** ..... 323
- Tire Quality Grading** ..... 331
- Tire temperature**
- Checking (tire pressure monitoring system) ..... 325
  - Tire pressure monitoring system (function) ..... 324
- Tire tread** ..... 320
- Tire-change tool kit**
- Overview ..... 342
- TIREFIT kit** ..... 303
- Storage location ..... 303
  - Using ..... 303
- Tires**
- Changing hub caps ..... 343
  - Characteristics ..... 334
  - Checking ..... 320
  - Checking the tire pressure (manually) ..... 324
  - Checking the tire pressure (tire pressure monitoring system) ..... 325
  - Definitions ..... 336
  - DOT, Tire Identification Number (TIN)  
..... 332
  - Flat tire ..... 303
  - Installing ..... 346
  - Load index ..... 334
  - Load-bearing capacity ..... 334
  - Maximum tire load ..... 333
  - Maximum tire pressure ..... 333
  - Noise ..... 320
  - Notes on installing ..... 339
  - Overview of tire labeling ..... 331

- Removing ..... 346
- Replacing ..... 339, 343
- Restarting the tire pressure monitoring system ..... 326
- Rotating ..... 342
- Selection ..... 339
- Snow chains ..... 321
- Speed rating ..... 334
- Storing ..... 342
- Temperature grade ..... 331
- Tire and Loading Information placard ..... 326
- Tire pressure (notes) ..... 321
- Tire pressure monitoring system (function) ..... 324
- Tire pressure table ..... 323
- Tire Quality Grading ..... 331
- Tire size designation ..... 334
- TIREFIT kit ..... 303
- Traction grade ..... 331
- Tread wear grade ..... 331
- Unusual handling characteristics ..... 320
- Toll system**
  - Windshield ..... 134
- Tongue weight** ..... 367
- Tool**
  - see Vehicle tool kit
- Top Tether** ..... 58
- Touch Control**
  - On-board computer ..... 243
  - Operating ..... 250
- Touchpad** ..... 250
  - Operating ..... 250
- Touchscreen (media display)**
  - Operating ..... 250
- Tow-away alarm**
  - Activating/deactivating ..... 86
  - Function ..... 86
- Tow-bar system** ..... 240
- Tow-starting** ..... 317
- Towing a trailer**
  - Notes ..... 236
- Towing away** ..... 314
- Towing eye**
  - Installing ..... 317
  - Storage location ..... 316
- Towing methods** ..... 313
- Traction grade** ..... 331
- Traffic information**
  - Switching on the display ..... 265
- Traffic Sign Assist** ..... 229
  - Function/notes ..... 229
  - Setting ..... 230
  - System limitations ..... 229
- Trailer hitch**
  - Attaching the ball neck ..... 237
  - Care ..... 299
  - Coupling up/uncoupling a trailer ..... 238
- Trailer operation**
  - Active Blind Spot Assist ..... 232
  - Active Lane Keeping Assist ..... 233
  - Attaching the ball neck ..... 237
  - Coupling up/uncoupling a trailer ..... 238
- Trailer stabilization**
  - Function/notes ..... 179
- Trailer tow hitch**
  - Axle load ..... 367
  - General notes ..... 366
  - Notes ..... 236
  - Tongue weight ..... 367
  - Towing capacity ..... 366

<b>Transmission position display</b> .....	160
<b>Transporting</b>	
Vehicle .....	315
<b>Tread wear grade</b> .....	331
<b>Trim element (Care)</b> .....	301
<b>Trunk lid</b>	
see Tailgate	
<b>Tuneln</b> .....	285
Calling up .....	285
<b>Turn signal indicator</b> .....	122
<b>Turn signal light</b>	
Activating/deactivating .....	122
<b>Two-way radios</b>	
Frequencies .....	354
Notes on installation .....	353
Transmission output (maximum) .....	354

## U

<b>Unlocking setting</b> .....	66
<b>Updates</b>	
Important system updates .....	257

<b>USB port</b>	
Rear passenger compartment .....	117

## V

<b>Vehicle</b> .....	144
Activating/deactivating standby mode .....	173
Collision detection (parking) .....	172
Correct use .....	28
Data acquisition .....	31
Data storage .....	31
Diagnostics connection .....	27
Equipment .....	23
Limited Warranty .....	31
Locking (automatically) .....	70
Locking (from inside) .....	69
Locking (KEYLESS-GO) .....	69
Locking/unlocking (emergency key) .....	71
Lowering .....	347
Maintenance .....	24
Medical aids .....	29
Parking for an extended period .....	173
Problem notification .....	29
QR code rescue card .....	31
Qualified specialist workshop .....	28

Raising .....	344
Standby mode function .....	173
Starting (emergency operation mode) .....	144
Starting (Remote Online) .....	146
Starting (start/stop button) .....	144
Switching off (start/stop button) .....	167
Towing .....	240
Unlocking (from inside) .....	69
Unlocking (KEYLESS-GO) .....	69
Ventilating (convenience opening) .....	79

## Vehicle data

Angle of approach/departure .....	365
Displaying (DYNAMIC SELECT) .....	159
Fording depth .....	365
Maximum gradient-climbing capability .....	365
Maximum speeds .....	364
Roof load .....	364
Turning radius .....	363
Vehicle height .....	363
Vehicle length .....	363
Vehicle width .....	363
Wheelbase .....	363



<b>Vehicle data storage</b>	
Event data recorders .....	33
MBUX multimedia system/Mercedes me connect .....	33
<b>Vehicle dimensions</b> .....	363
<b>Vehicle electronics</b>	
Notes .....	353
Two-way radios .....	353
<b>Vehicle identification number</b>	
see VIN	
<b>Vehicle identification plate</b> .....	355
Paint code .....	355
VIN .....	355
<b>Vehicle interior</b>	
Cooling or heating (Remote Online) .....	145
<b>Vehicle key</b>	
see SmartKey	
<b>Vehicle level</b>	
Setting individual wheel control .....	211
<b>Vehicle maintenance</b>	
see ASSYST PLUS	
<b>Vehicle operation</b>	
Outside the USA or Canada .....	24

<b>Vehicle tool kit</b> .....	303
TIREFIT kit .....	303
Towing eye .....	316
<b>Vehicle with a high center of gravity</b> .....	29
<b>Ventilating</b>	
Convenience opening .....	79
<b>Ventilation</b>	
see Climate control	
<b>Vents</b>	
see Air vents	
<b>VIN</b> .....	355
Identification plate .....	355
Seat .....	355
Windshield .....	355
<b>Vision</b>	
Removing condensation from the windows .....	138
Windshield heater .....	140
<b>Voice Control System</b>	
Function .....	251
Starting .....	252









**W****Warning lamps**















see Warning/indicator lamps

**Warning system**

see ATA (anti-theft alarm system)

**Warning/indicator lamp**

 ABS warning lamp .....	427
 Brake system warning lamp (Canada only) .....	425
 Brake warning lamp (USA only) ..	425
 Coolant warning lamp .....	421
 Electric parking brake indicator lamp (red) (Canada only) .....	424
 Electric parking brake indicator lamp (red) (USA only) .....	424
 Electric power steering warn- ing lamp (red) .....	420
 Electrical malfunction warning lamp .....	422
 Engine diagnosis warning lamp ..	422

-  ESP® OFF warning lamp ..... 428
-  ESP® warning lamp flashes ..... 428
-  ESP® warning lamp lights up ..... 428
-  Fuel reserve warning lamp  
flashes ..... 423
-  Fuel reserve warning lamp  
lights up ..... 423
-  Restraint system warning lamp ... 419
-  Seat belt warning lamp flashes ... 419
-  Seat belt warning lamp lights  
up ..... 420
-  Suspension warning lamp (red)  
..... 426
-  Suspension warning lamp (yel-  
low) ..... 426
-  The electric parking brake (yel-  
low) indicator lamp ..... 424
-  Tire pressure monitoring sys-  
tem warning lamp flashes ..... 429
-  Tire pressure monitoring sys-  
tem warning lamp lights up ..... 430
-  Warning lamp for distance  
warning function ..... 426
- Warning/indicator lamps** ..... 417
  - Overview ..... 417
  - PASSENGER AIR BAG ..... 46
- Warranty** ..... 31
- Washer fluid**  
see Windshield washer fluid
- Washing by hand (care)** ..... 298
- Water tank**  
see Air-water duct
- Weather information** ..... 265
- Web browser**  
Overview ..... 275
- Wheel change**
  - Lowering the vehicle ..... 347
  - Mounting a new wheel ..... 346
  - Removing a wheel ..... 346
  - Removing/installing hub caps ..... 343
- Wheel rotation** ..... 342
- Wheels**
  - Care ..... 299
  - Changing hub caps ..... 343
  - Checking ..... 320
  - Checking the tire pressure (man-  
ually) ..... 324
  - Checking the tire pressure (tire pres-  
sure monitoring system) ..... 325
  - Definitions ..... 336
  - DOT, Tire Identification Number (TIN)  
..... 332
  - Flat tire ..... 303
  - Installing ..... 346
  - Load index ..... 334
  - Load-bearing capacity ..... 334
  - Maximum tire load ..... 333
  - Maximum tire pressure ..... 333
  - Noise ..... 320
  - Notes on installing ..... 339
  - Overview of tire labeling ..... 331
  - Removing ..... 346
  - Replacing ..... 339, 343
  - Restarting the tire pressure monitor-  
ing system ..... 326
  - Rotating ..... 342
  - Selection ..... 339

- Snow chains ..... 321
- Speed rating ..... 334
- Storing ..... 342
- Temperature grade ..... 331
- Tire and Loading Information placard  
..... 326
- Tire characteristics ..... 334
- Tire pressure (notes) ..... 321
- Tire pressure monitoring system  
(function) ..... 324
- Tire pressure table ..... 323
- Tire Quality Grading ..... 331
- Tire size designation ..... 334
- TIREFIT kit ..... 303
- Traction grade ..... 331
- Tread wear grade ..... 331
- Unusual handling characteristics ..... 320
- Wi-Fi**  
Setting ..... 258
- Window curtain airbag** ..... 42
- Windows**  
see Side windows
- Windows (Care)** ..... 299
- Windshield** ..... 128, 130, 135
- Defrosting ..... 135
- Infrared reflective ..... 134
- Radio waves ..... 134
- Replacing the wiper blades ..... 128
- Replacing wiper blades (MAGIC  
VISION CONTROL) ..... 130
- Windshield**  
see Windshield
- Windshield heater** ..... 140
- Windshield heating**  
see Windshield heater
- Windshield washer fluid** ..... 362
- Notes ..... 362
- Windshield washer system**  
Topping up ..... 294
- Windshield wipers**  
Activating/deactivating ..... 128
- Replacing the wiper blades ..... 128
- Replacing wiper blades (MAGIC  
VISION CONTROL) ..... 130
- Winter operation**  
Snow chains ..... 321
- Wiper blades**  
Care ..... 299
- Replacing ..... 128
- Replacing (MAGIC VISION CONTROL)  
..... 130
- Wireless charging**  
Function/notes ..... 118
- Mobile phone ..... 119
- Wireless vehicle components**  
Declaration of conformity ..... 27
- Workout program**  
Overview ..... 95
- Workshop**  
see Qualified specialist workshop

