



#### Digital – in the vehicle

Familiarize yourself with the contents of the Operator's Manual directly via the vehicle's multimedia system (menu item "Vehicle information"). Start with the quick guide or broaden your knowledge with practical tips.



#### Vehicle document wallet

Here you can find comprehensive information about operating your vehicle and about services and guarantees in printed form.



2575840704

Order no. P257 0267 13 Part no. 257 584 07 04  
Edition B-2022

CLS

Mercedes-Benz



# CLS

Operator's Manual

Mercedes-Benz



## Front passenger airbag warning

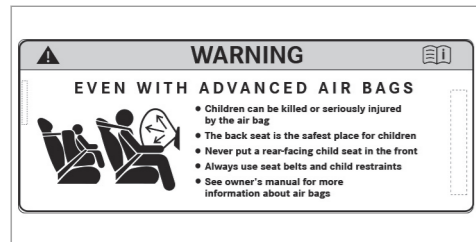

Airbag warning sticker for USA and Canada

## **⚠ WARNING** Risk of injury or death if the co-driver airbag is enabled

If the co-driver airbag is enabled, a child on the co-driver seat may be struck by the co-driver airbag during an accident.

NEVER use a rearward-facing child restraint system on a seat with an ENABLED FRONT AIRBAG; DEATH or SERIOUS INJURY to the CHILD can occur.

Observe the chapter "Children in the vehicle".

## Publication details

### Internet

Further information about Mercedes-Benz vehicles and about Mercedes-Benz AG can be found on the following websites:

<https://www.mbusa.com> (USA only)

<https://www.mercedes-benz.ca> (Canada only)

### Documentation team

©Mercedes-Benz AG: Not to be reprinted, translated or otherwise reproduced, in whole or in part, without written permission from Mercedes-Benz AG.

### Vehicle manufacturer

Mercedes-Benz AG

Mercedesstraße 120

70372 Stuttgart

Germany

As at 17.02.21



## Thank you for buying Mercedes-Benz

Before you first drive off, read this Operator's Manual carefully and familiarize yourself with your vehicle. For your own safety and a longer operating lifespan of the vehicle, follow the instructions and warning notices in this Operator's Manual. Disregarding them may lead to damage to the vehicle or injury to people.

Damage to the vehicle resulting from the disregard of the instructions is not covered by the Mercedes-Benz Limited Warranty.

The standard equipment and product description of your vehicle may vary and depends on the following factors:

- Model
- Order
- National version
- Availability

Your vehicle may therefore differ, in individual cases, from that shown in the descriptions and illustrations.

Mercedes-Benz reserves the right to introduce changes in the following areas:

- Design
- Equipment
- Technical features

The following documents are integral parts of the vehicle:

- Digital Operator's Manual
- Printed Operator's Manual
- Maintenance Booklet
- Equipment-dependent supplements
- Supplementary documents

Keep these documents in the vehicle at all times. Ensure that all documents are in the vehicle or passed on in the event of sale or rental.

Mercedes-Benz USA, LLC

Mercedes-Benz Canada, Inc.

A Daimler Company

2575840704



<b>Symbols</b> .....	5	Notes for persons with electronic medical aids .....	25	Anti-theft protection .....	80
<b>At a glance</b> .....	6	Problems with your vehicle .....	26	<b>Seats and stowing</b> .....	<b>84</b>
Cockpit .....	6	Reporting safety defects .....	26	Notes on the correct driver's seat position ....	84
Indicator and warning lamps .....	8	Limited Warranty .....	27	Seats .....	84
Overhead control panel .....	10	QR code for rescue card .....	27	Steering wheel .....	92
Door operating unit and seat adjustment .....	12	Data storage .....	27	Easy entry and exit feature .....	94
Emergencies and breakdowns .....	14	Copyright .....	32	Memory function .....	95
<b>Digital Operator's Manual</b> .....	<b>16</b>	<b>Occupant safety</b> .....	<b>33</b>	Stowage areas .....	97
Calling up the Digital Operator's Manual .....	16	Restraint system .....	33	Sockets .....	106
<b>General notes</b> .....	<b>18</b>	Seat belts .....	35	Wireless charging of the mobile phone and connection with the exterior antenna ....	107
Protection of the environment .....	18	Airbags .....	39	Installing/removing the floor mats .....	109
Genuine Mercedes-Benz parts .....	18	PRE-SAFE® system .....	46	<b>Light and visibility</b> .....	<b>111</b>
Operator's Manual .....	19	Safely transporting children in the vehicle .....	47	Exterior lighting .....	111
Service and vehicle operation .....	20	Notes on pets in the vehicle .....	60	Interior lighting .....	119
Operating safety .....	21	<b>Opening and closing</b> .....	<b>61</b>	Windshield wiper and windshield washer system .....	121
Declaration of conformity for vehicle installed radio components .....	23	SmartKey .....	61	Mirrors .....	123
Diagnostics connection .....	24	Doors .....	65	Area permeable to radio waves on the windshield .....	126
Qualified specialist workshop .....	25	Trunk .....	68	Infrared-reflective windshield function .....	126
Correct use of the vehicle .....	25	Side windows .....	74		
		Sliding sunroof .....	77		
		Roller sun blinds .....	80		

<b>Climate control</b> .....	<b>127</b>	<b>MBUX multimedia system</b> .....	<b>223</b>	<b>Wheels and tires</b> .....	<b>301</b>
Overview of climate control systems .....	127	Overview and operation .....	223	Notes on noise or unusual handling characteristics .....	301
Operating the climate control system .....	128	System settings .....	232	Notes on regularly inspecting wheels and tires .....	301
<b>Driving and parking</b> .....	<b>134</b>	Navigation .....	237	Notes on snow chains .....	302
Driving .....	134	Telephone .....	245	Tire pressure .....	302
DYNAMIC SELECT switch .....	146	Mercedes me app .....	249	Loading the vehicle .....	308
Automatic transmission .....	148	Mercedes-Benz emergency call system .....	256	Tire labeling .....	313
Function of the 4MATIC .....	153	Radio & media .....	259	Definition of terms for tires and loading .....	318
Refueling .....	153	Sound settings .....	266	Changing a wheel .....	320
Parking .....	155	<b>Maintenance and care</b> .....	<b>267</b>	Emergency spare wheel .....	330
Driving and driving safety systems .....	162	ASSYST PLUS service interval display .....	267	<b>Technical data</b> .....	<b>332</b>
Vehicle towing instructions .....	215	Engine compartment .....	268	Notes on technical data .....	332
<b>Instrument display and on-board computer</b> .....	<b>216</b>	Cleaning and care .....	274	Vehicle electronics .....	332
Notes on the instrument display and on-board computer .....	216	<b>Breakdown assistance</b> .....	<b>281</b>	Regulatory radio identification and notes .....	334
Overview of instrument display .....	217	Emergency .....	281	Vehicle identification plate, VIN and engine number overview .....	335
Overview of buttons on the steering wheel .....	218	Flat tire .....	282	Operating fluids .....	336
Operating the on-board computer .....	218	Battery (vehicle) .....	288	Vehicle data .....	343
Overview of displays on the instrument display .....	220	Tow starting or towing away .....	293		
Head-up Display .....	220	Electrical fuses .....	297		

---

**Display messages and warning/indicator**

<b>lamps</b> .....	<b>345</b>
Display messages .....	345
Warning and indicator lamps .....	397

---

<b>Index</b> .....	<b>413</b>
--------------------	------------



In this Operator's Manual, you will find the following symbols:

**⚠ DANGER** Danger due to not observing the warning notices

Warning notices draw your attention to hazards that may endanger your health or life, or the health or life of others.

- ▶ Observe the warning notices.

**🌿 ENVIRONMENTAL NOTE** Environmental damage due to failure to observe environmental notes

Environmental notes include information on environmentally responsible behavior or environmentally responsible disposal.

- ▶ Observe environmental notes.

**! NOTE** Damage to property due to failure to observe notes on material damage

Notes on material damage inform you of risks which may lead to your vehicle being damaged.

- ▶ Observe notes on material damage.

**ⓘ** These symbols indicate useful instructions or further information that could be helpful to you.

▶ Instruction

(→ page) Further information on a topic

**Display** Display field in the Instrument Display/media display







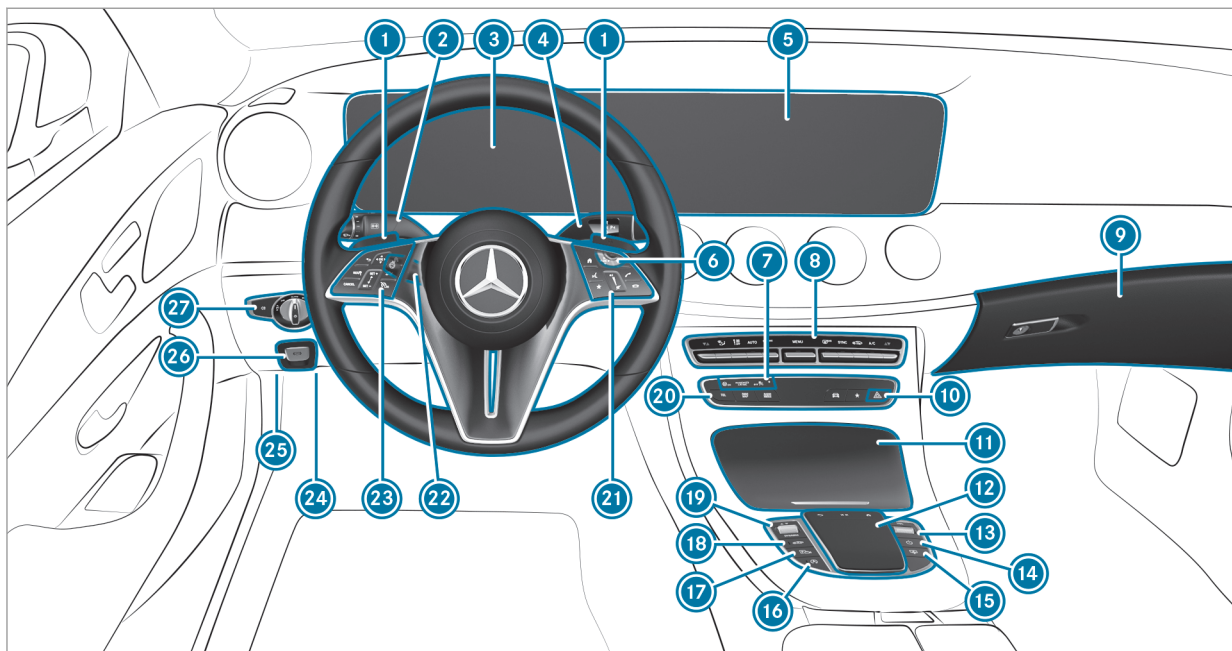



↗▶ Highest menu level, which is to be selected in the multimedia system

▶▶ Relevant submenus, which are to be selected in the multimedia system

\* Indicates a cause







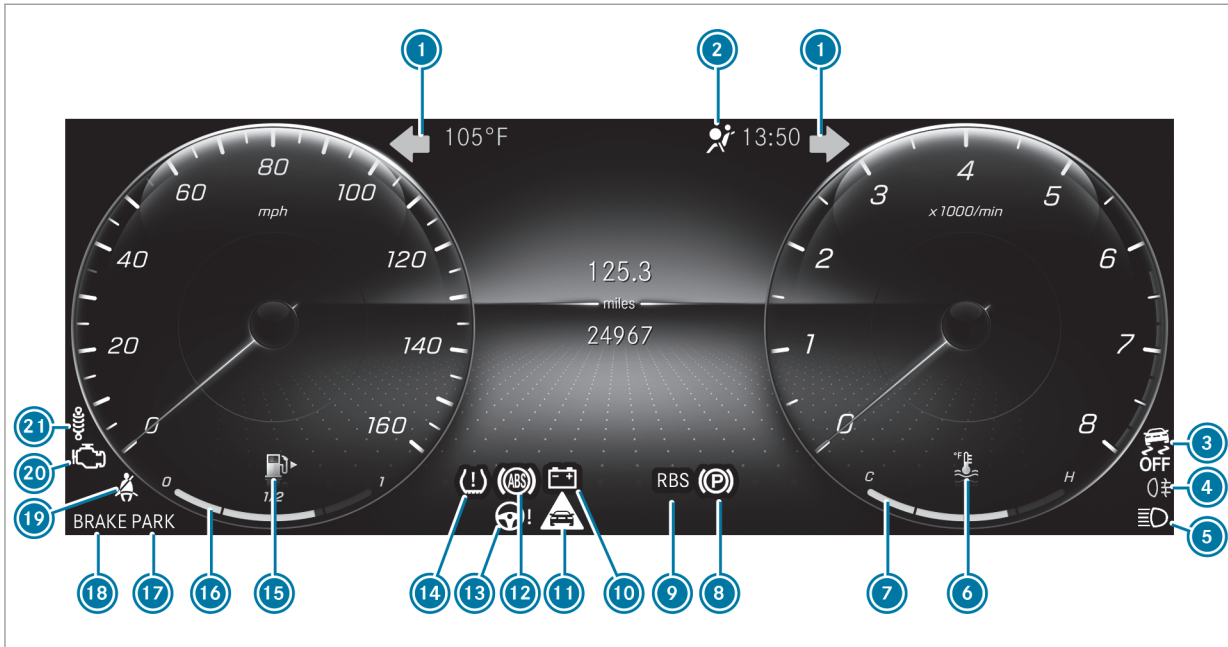

















Left-hand-drive vehicles

1	Steering wheel gearshift paddles	→	151	16	 ECO start/stop function	→	143
2	Combination switch	→	112	17	 Active Parking Assist	→	212
3	Instrument display	→	217	18	 Sets the vehicle level	→	197
4	DIRECT SELECT lever	→	148	19	DYNAMIC SELECT switch	→	147
5	Media display	→	223	20	Calls up MBUX multimedia system applications	→	226
6	Start/stop button	→	135	21	Control panel for the MBUX multimedia system	→	218
7	PASSENGER AIR BAG indicator lamps	→	43	22	Adjusts the steering wheel electrically	→	93
8	Climate control systems	→	128		 Switches the steering wheel heater on/off	→	94
9	Glove box	→	100	23	Control panel:		
10	 Hazard warning light system	→	113		On-board computer	→	218
11	Storage compartment	→	100		Cruise control	→	171
12	Touchpad	→	226		 Active Distance Assist DISTRONIC	→	174
13	 Controller for volume and switching sound on/off	→	223	24	Diagnostics connection	→	24
14	 Switches the MBUX multimedia system on/off	→	223	25	Opens the hood	→	268
15	 Rear window roller sunblind	→	80	26	 Electric parking brake	→	159
				27	Light switch	→	111









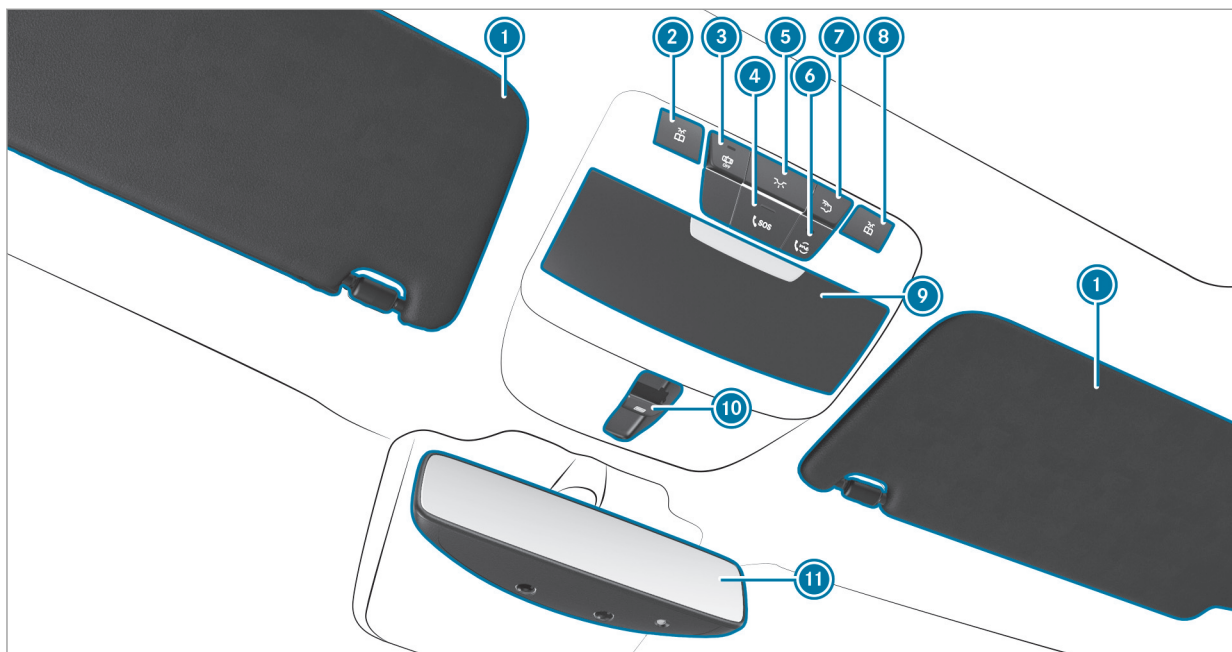

Instrument display



1		Turn signal lights	→	112	12		ABS	→	408
2		Restraint system	→	398	13		Electric power steering	→	399
3		ESP® OFF	→	408	14		Tire pressure monitoring system	→	411
		ESP®	→	408	15		Reserve fuel with fuel filler flap location indicator	→	400
4		Rear fog light	→	112	16		Fuel level	→	217
5		High beam	→	112	17		Electric parking brake (red)	→	404
		Low beam	→	111		<b>PARK</b>	USA only		
		Parking lights	→	111			Canada only		
6		Coolant temperature	→	400	18		Brakes (red)	→	404
7		Coolant temperature display	→	217		<b>BRAKE</b>	USA only		
8		Electric parking brake (yellow)	→	404			Canada only		
9	<b>RBS</b>	Recuperative Brake System, USA only	→	404	19		Seat belt	→	398
		Brakes (yellow), Canada only	→	404	20		Check Engine	→	400
10		Electrical malfunction	→	400	21		Suspension	→	407
11		Distance warning	→	407					

10 At a glance – Overhead control panel







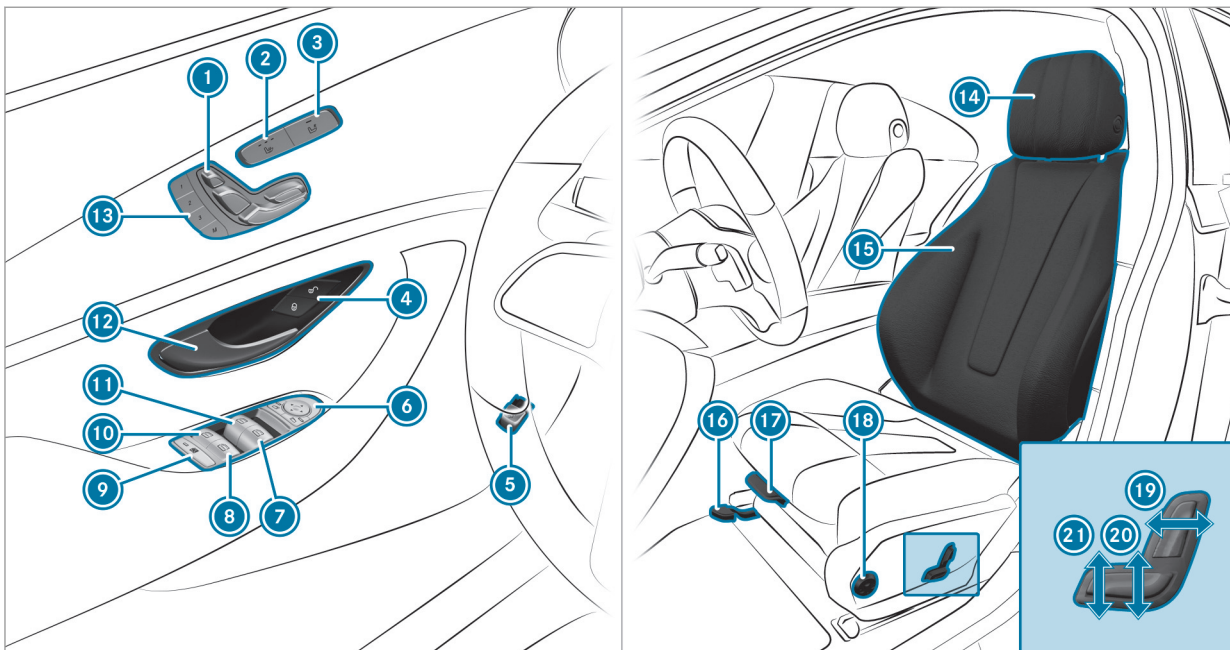







1	Sun visors		
2	 Switches the left-hand reading lamp on/off	→	119
3	 Switches the automatic interior lighting control on/off	→	119
4	 SOS button	→	249
5	 Switches the front interior lighting on/off	→	119
6	 me button	→	249
7	 Switches the rear interior lighting on/off	→	119
8	 Switches the right-hand reading lamp on/off	→	119
9	Eyeglasses compartment		
10	 Opens/closes the sliding sunroof	→	77
11	Inside rearview mirror	→	124



## 12 At a glance - Door operating unit and seat adjustment



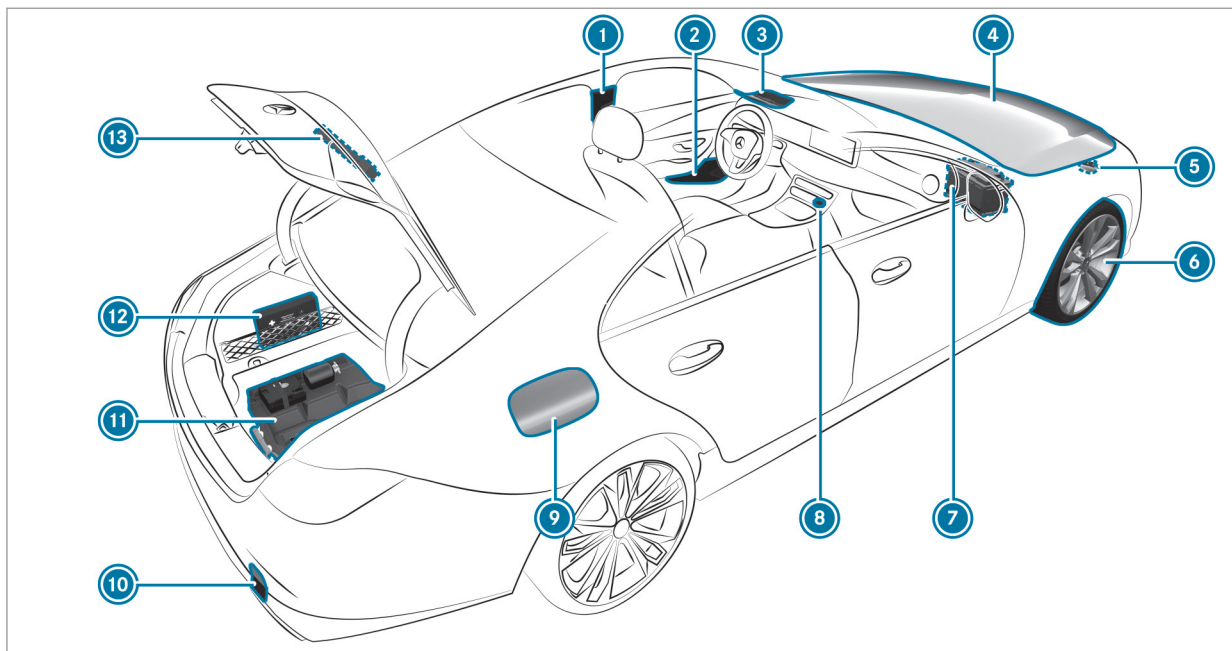

①	Adjusts the seats electrically	→	87	⑫	Opens the door	→	65
②	 Switches the seat heating on/off	→	91	⑬	 Operates the memory function	→	96
③	 Switches the seat ventilation on/off	→	92	⑭	Adjusts the head restraints	→	87
④	  Locks/unlocks the vehicle	→	65	⑮	Configures the seat settings	→	89
⑤	 Opens/closes the trunk lid	→	68	⑯	Adjusts the seat fore-and-aft position	→	84
⑥	 Operates the outside mirrors	→	123	⑰	Adjusts the seat cushion length	→	84
⑦	 Opens/closes the right side window	→	74	⑱	Adjusts the 4-way lumbar support	→	84
⑧	 Opens/closes the rear right side window	→	74	⑲	Adjusts the seat backrest inclination	→	84
⑨	 Child safety lock for the rear side windows	→	59	⑳	Adjusts the seat height	→	84
⑩	 Opens/closes the rear left side window	→	74	㉑	Adjusts the seat cushion inclination	→	84
⑪	 Opens/closes the left side window	→	74				



① B-pillar with:		
QR code for accessing the rescue card	→	27
② Safety vests	→	281
③  me button	→	249
 SOS button	→	249
④ To check and refill operating fluids	→	336
⑤ Tow-starting or towing away	→	293
⑥ Flat tire	→	282
⑦ Starting assistance	→	291

⑧  Hazard warning light system	→	113
⑨ Fuel filler flap with:		
Information label on fuel type	→	153
Information label on tire pressure	→	304
QR code for accessing the rescue card	→	27
⑩ Tow-starting or towing away	→	293
⑪ TIREFIT kit	→	284
⑫ First-aid kit (soft sided)	→	282
⑬ Warning triangle	→	281

### Calling up the Digital Operator's Manual

Multimedia system:

→ [Home] ▶▶ Info ▶▶ Operator's Manual  
▶▶ [Info]



The Digital Operator's Manual describes the functions and operation of the vehicle and the multimedia system.

▶ Select one of the following menu items in the Digital Operator's Manual:

- **Search:** search for keywords in order to find quick answers to questions about the operation of the vehicle.

- **Quick start:** here is where you find the first steps towards setting up your vehicle.
- **Tips:** find information that prepares you for certain everyday situations with your vehicle.
- **Animations:** watch animations of the vehicle functions.
- **Messages:** receive additional information about the messages in the Instrument Display.
- **Bookmarks:** gain access to your personally saved bookmarks.
- **Language:** select the language for the Digital Operator's Manual.

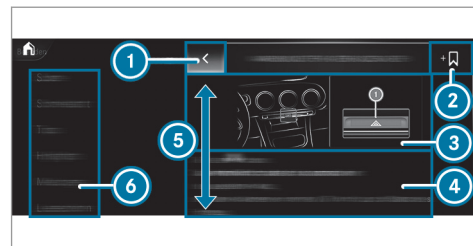

- 1 Back
- 2 Adds bookmarks
- 3 Picture
- 4 Contents section
- 5 Directions of movement of contents section
- 6 Menu

Some sections in the Digital Operator's Manual, such as warning notes, can be expanded and collapsed.

**Additional methods of calling up the Digital Operator's Manual:**

**Direct access:** open the required content in the Digital Operator's Manual by pressing and holding an entry on the tab bar in the multimedia system:

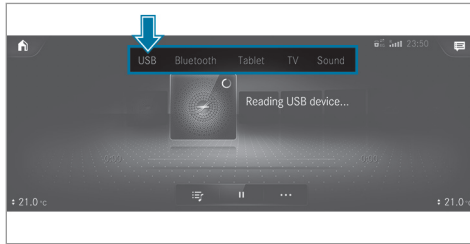

**Instrument Display:** call up brief information as display messages in the instrument cluster

**Voice Control System:** call up via the voice control system

For safety reasons, the Digital Operator's Manual is deactivated while driving.

## Protection of the environment



**ENVIRONMENTAL NOTE** Environmental damage due to operating conditions and personal driving style

The pollutant emission of the vehicle is directly related to the way you operate the vehicle.

Operate your vehicle in an environmentally responsible manner to help protect the environment. Please observe the following recommendations on operating conditions and personal driving style.

### Operating conditions:

- ▶ Make sure that the tire pressure is correct.
- ▶ Do not carry any unnecessary weight (e.g. roof luggage racks once you no longer need them).
- ▶ Adhere to the service intervals. A regularly serviced vehicle will contribute to environmental protection.

- ▶ Always have maintenance work carried out at a qualified specialist workshop.

### Personal driving style:

- ▶ Do not depress the accelerator pedal when starting the engine.
- ▶ Do not warm up the vehicle while stationary.
- ▶ Drive carefully and maintain a suitable distance from the vehicle in front.
- ▶ Avoid frequent, sudden acceleration and braking.
- ▶ Change gear in good time and use each gear only up to  $\frac{2}{3}$  of its maximum engine speed.
- ▶ Switch off the vehicle in stationary traffic, e.g. by using the ECO start/stop function.
- ▶ Drive in a fuel-efficient manner. Observe the ECO display for an economical driving style.

## Environmental issues and recommendations

It is recommended that you re-use or recycle materials instead of just disposing of them.

The relevant environmental guidelines and regulations serve to protect the environment and must be strictly observed.

## Genuine Mercedes-Benz parts



**ENVIRONMENTAL NOTE** Environmental damage due to not using recycled reconditioned components

Mercedes-Benz AG offers recycled reconditioned components and parts with the same quality as new parts. The same entitlement from the Limited Warranty is valid as for new parts.

- ▶ Use recycled reconditioned components and parts from Mercedes-Benz AG.

**!** **NOTE** Impairment of the operating efficiency of the restraint systems from installing accessory parts or from repairs or welding

Airbags and Emergency Tensioning Devices, as well as control units and sensors for the restraint systems, may be installed in the following areas of your vehicle:

- Doors
- Door pillars
- Door sills
- Seats
- Cockpit
- Instrument cluster
- Center console
- Lateral roof frame

- ▶ Do not install accessory parts such as audio systems in these areas.
- ▶ Do not carry out repairs or welding.
- ▶ Have accessory parts retrofitted at a qualified specialist workshop.

You could jeopardize the operating safety of your vehicle if you use parts, tires and wheels as well as accessories relevant to safety which have not been approved by Mercedes-Benz. Safety-relevant systems, e.g. the brake system, may malfunction. Only use genuine Mercedes-Benz parts or parts of equal quality. Only use tires, wheels and accessory parts that have been specifically approved for your vehicle model.

Genuine Mercedes-Benz parts are subject to strict quality inspections. Each part has been specially developed, manufactured or selected for Mercedes-Benz vehicles and adapted to them. Therefore, only genuine Mercedes-Benz parts should be used.

More than 300,000 different genuine Mercedes-Benz parts are available for Mercedes-Benz models.

All authorized Mercedes-Benz Centers maintain a supply of genuine Mercedes-Benz parts for necessary service and repair work. In addition, strategically located parts delivery centers provide for quick and reliable parts service.

Always specify the vehicle identification number (VIN) (→ page 335) when ordering genuine Mercedes-Benz parts.

### Operator's Manual

This Operator's Manual and the Digital Operator's Manual in the vehicle describe the following models and the standard and special equipment for your vehicle:

- The models and the standard and special equipment available at the time of this Operator's Manual going to press.
- The models and the standard and special equipment only available in certain countries.
- The models and the standard and special equipment, which will only be available at a later date.

Note that your vehicle may not be equipped with all features described. This is also the case for systems relevant to safety. Therefore, the equipment on your vehicle may differ from that in the descriptions and illustrations.

The original purchase agreement for your vehicle contains a list of the equipment in your vehicle at the time of delivery.

Should you have any questions concerning equipment and operation, please consult an authorized Mercedes-Benz Center.

The Operator's Manual, Supplement, further supplementary documents and Maintenance Booklet are important documents and should be kept in the vehicle.

## Service and vehicle operation

### Vehicle operation outside the USA or Canada

When you are abroad with your vehicle, observe the following points:

- Service points or replacement parts may not be available immediately.
- Unleaded fuel may not be available for vehicles with a catalytic converter. Leaded fuel may cause damage to the catalytic converter.
- The fuel may have an extremely low octane number. Unsuitable fuel can cause engine damage.

Some Mercedes-Benz models are available in Europe through our European Delivery Program. For more information, please consult an authorized Mercedes-Benz service center, or write to one of the following address:

#### **In the USA:**

Mercedes-Benz USA, LLC  
European Delivery Department  
One Mercedes-Benz Drive  
Sandy Springs, GA 30328

#### **In Canada:**

Mercedes-Benz Canada, Inc.  
European Delivery Department  
98 Vanderhoof Avenue  
Toronto, Ontario M4G 4C9

### Maintenance

Your customer advisor confirms the service in the service report.

### Roadside Assistance

The Mercedes-Benz Roadside Assistance Program offers technical help in the case of a breakdown. Your calls to the toll-free Roadside Assistance Hotline are answered by our agents 24 hours a day, 365 days a year.

1-800-FOR-MERCedes (1-800-367-6372) (USA)  
1-800-387-0100 (Canada)

You can find further information in the Mercedes-Benz Roadside Assistance Program brochure (USA) or the "Roadside Assistance" section in the Service and Warranty booklet (Canada). You will find both in the vehicle document wallet.

### Change of address or change of ownership

In the event of a change of address, please send us the "Notification of address change" in the Service and Guarantee booklet or simply call the Mercedes-Benz Customer Assistance Center (USA) on the hotline number 1-800-FOR-MERCedes (1-800-367-6372) or Customer Service (Canada) on 1-800-387-0100. We



can then reach you in a timely fashion, if necessary.

If you sell your Mercedes, please leave all literature in the vehicle so that it is available to the next owner. If you have purchased a used vehicle, please send us the "Notice of Purchase of Used Car" in the Service and Guarantee booklet or simply call the Mercedes-Benz Customer Assistance Center (USA) at the hotline number 1-800-FOR-MERCEdes (1-800-367-6372) or Customer Service (Canada) at 1-800-387-0100.

### Possible danger due to substances hazardous to health

In compliance with Proposition 65 ("Prop65"), the following detachable label has been added to each vehicle sold in California:



**WARNING**



Operating, servicing and maintaining a passenger vehicle, pickup truck, van or off-road motor vehicle can expose you to chemicals including engine exhaust, carbon monoxide, phthalates, and lead, which are known to the State of California to cause cancer and birth defects or other reproductive harm. To minimize exposure, avoid breathing exhaust, do not idle the engine except as necessary, service your vehicle in a well-ventilated area and wear gloves or wash your hands frequently when servicing your vehicle. For more information go to [www.P65Warnings.ca.gov/passenger-vehicle](http://www.P65Warnings.ca.gov/passenger-vehicle)

A 000 817 82 02

### Operating safety

 **WARNING** Risk of accident due to malfunctions or system failures

To avoid malfunctions or system failures:

- ▶ Always have the prescribed service and maintenance work as well any required repairs carried out at a qualified specialist workshop.

 **WARNING** Risk of accident or injury due to incorrect modifications on electronic component parts

Modification of electronic components, their software or wiring could impair their function and/or the function of other networked component parts or safety-relevant systems.

This can endanger the operating safety of the vehicle.

- ▶ Never tamper with the wiring and electronic component parts or their software.
- ▶ You should have all work on electrical and electronic components carried out at a qualified specialist workshop.

Observe the "On-board electronics" section in "Technical data".

**⚠ WARNING** Risk of fire due to flammable materials on hot parts of the exhaust system

Flammable material such as leaves, grass or twigs may ignite if they come into contact with hot parts of the exhaust system.

- ▶ When driving on unpaved roads or off-road, regularly check the vehicle underside.
- ▶ Remove trapped plants or other flammable material, in particular.
- ▶ If there is damage, consult a qualified specialist workshop immediately.

**! NOTE** Damage to the vehicle due to driving too fast and due to impacts to the vehicle underbody or suspension components

In the following situations, in particular, there is a risk of damage to the vehicle:

- The vehicle becomes grounded, e.g. on a high curb or an unpaved road
- The vehicle is driven too fast over an obstacle, e.g. a curb, speed bump or pothole
- A heavy object strikes the underbody or suspension components

In situations such as these, damage to the body, underbody, suspension components, wheels or tires may not be visible. Components damaged in this way can unexpectedly fail or, in the case of an accident, may no longer absorb the resulting force as intended.

If the underbody paneling is damaged, flammable materials such as leaves, grass or twigs can collect between the underbody and the

underbody paneling. These materials may ignite if they come into contact with hot parts of the exhaust system.

- ▶ Have the vehicle checked and repaired immediately at a qualified specialist workshop.

or

- ▶ If driving safety is impaired while continuing your journey, pull over and stop the vehicle immediately, while paying attention to road and traffic conditions, and contact a qualified specialist workshop.

### Vehicles with a 48 V on-board electrical system

**⚠ DANGER** Risk of fatal injury by touching damaged high-voltage components

Vehicles with a 48 V on-board electrical system contain individual high-voltage components. These high-voltage components are under high voltage.

If you modify component parts of these high-voltage components or touch damaged component parts, you may be electrocuted.

High voltage components may be damaged in an accident, although the damage may not be visible.

- ▶ Never perform modifications to component parts of high-voltage components.
- ▶ Never touch damaged component parts of high-voltage components.
- ▶ Never touch component parts of high-voltage components after an accident.

Vehicles with a 48 V on-board electrical system contain high voltage components. These components are marked with a high voltage label:

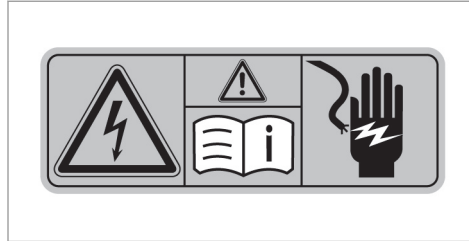

All work on high voltage components must be carried out at a qualified specialist workshop.

#### Declaration of conformity for vehicle installed radio components



USA: "Radio based devices of this vehicle comply with Part 15 of the FCC Rules. Operation is subject to the following two conditions: 1) These devices may not cause harmful interference, and 2) These devices must accept any interference received, including interference that may cause

undesired operation.Changes or modifications not expressly approved by the party responsible for compliance could void the user's authority to operate the equipment."

Canada: "This vehicle contains licence-exempt transmitter(s)/receiver(s) that comply with Innovation, Science and Economic Development Canada's licence-exempt RSS(s). Operation is subject to the following two conditions: (1) These devices may not cause interference. (2) These devices must accept any interference, including interference that may cause undesired operation of the devices." "Les émetteurs/récepteurs dans cette véhicule sont conforme aux CNR d'Innovation, Sciences et Développement économique Canada applicables aux appareils radio exempts de licence. L'exploitation est autorisée aux deux conditions suivantes : 1) Ces appareils ne doivent pas produire de brouillage; 2) Ces appareils doivent accepter tout brouillage radioélectrique subi, même si le brouillage est susceptible d'en compromettre le fonctionnement."

### Diagnostics connection

The diagnostics connection is a technical interface in the vehicle. It is used, for example, in the context of repair and maintenance work or for reading out vehicle data by a specialist workshop. Diagnostic devices should therefore only be connected by a qualified specialist workshop.

**⚠ WARNING** Risk of accident due to connecting devices to the diagnostics connection

If you connect devices to the diagnostics connection of the vehicle, the function of vehicle systems and operating safety may be impaired.

- ▶ For safety reasons, we recommend that you only use and connect products approved by your authorized Mercedes-Benz Center.

**⚠ WARNING** Risk of accident due to objects in the driver's footwell

Objects in the driver's footwell may impede pedal travel or block a depressed pedal.

This jeopardizes the operating and road safety of the vehicle.

- ▶ Stow all objects in the vehicle securely so that they cannot get into the driver's footwell.
- ▶ Always install the floor mats securely and as prescribed in order to ensure that there is always sufficient room for the pedals.
- ▶ Do not use loose floor mats and do not place floor mats on top of one another.

**! NOTE** Battery discharging from using devices connected to the diagnostics connection

Using devices at the diagnostics connection drains the battery.

- ▶ Check the charge level of the battery.

- ▶ If the charge level is low, charge the battery, e.g. by driving a considerable distance.

Please also note the information about the 12 V battery and short-distance trips in the "Driving and Parking" chapter (→ page 139).

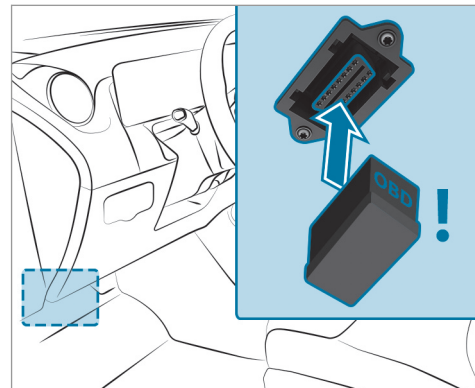

Connecting and using another device with the diagnostics connection can have the following effects:

- Malfunctions in the vehicle system
- Permanent damage to vehicle components

Please refer to the warranty terms and conditions for this matter.

Moreover, connecting equipment to the diagnostics connection can lead to emissions monitoring information being reset, for example. This may lead to the vehicle failing to meet the requirements of the next emissions inspection during the main inspection.

#### Qualified specialist workshop

An authorized Mercedes-Benz Center is a qualified specialist workshop. It has the necessary special skills, tools and qualifications to correctly carry out the work required on your vehicle. This particularly applies to safety-relevant works.

For the following, always have your vehicle checked at an authorized Mercedes-Benz Center:

- Safety-relevant works
- Service and maintenance work
- Repair work
- Modifications as well as installations and conversions
- Work on electronic components
- **Vehicles with 48 V on-board electrical system:** work on the high-voltage component of the 48 V on-board electrical system

Mercedes-Benz recommends a Mercedes-Benz service center.

#### Correct use of the vehicle

If you remove any warning stickers, you or others could fail to recognize certain dangers. Leave warning stickers in position.

Observe the following information in particular when driving your vehicle:

- The safety notes in this Operator's Manual, vehicle-specific supplements and further supplementary documents
- Technical data for the vehicle
- Traffic rules and regulations
- Laws and safety standards pertaining to motor vehicles

#### Notes for persons with electronic medical aids

Mercedes-Benz AG cannot, despite carefully developing vehicle systems, completely rule out the interaction of vehicle systems with electronic medical aids such as cardiac pacemakers.

In addition, there are components installed in the vehicle that, regardless of the operating status of the vehicle, can generate magnetic fields on a par with permanent magnets. These fields can be found, for example, in the area around the multimedia and sound system or also in the area of the seats, depending on the vehicle equipment.

For this reason, the following can occur in isolated cases, depending on the aids used:

- Medical aids malfunctioning
- Adverse health effects

Observe the notes and warnings of the manufacturer of the medical aids; if in doubt, contact the device manufacturer and/or your doctor. If there is continuing uncertainty concerning the possibility of medical aids malfunctioning, Mercedes-Benz AG recommends using only few electrical vehicle systems and/or maintaining a distance from the components.

Only have repairs and maintenance work in the area of the following components carried out by a qualified specialist workshop:

- Vehicle components carrying live voltage
- Transmission antenna
- Multimedia system and sound system

If you have any queries or suggestions, consult a qualified specialist workshop.

### Problems with your vehicle

If you should experience a problem with your vehicle, particularly one that you believe may affect its safe operation, we urge you to contact an authorized Mercedes-Benz Center immediately to have the problem diagnosed and rectified. If the problem is not resolved to your satisfaction, please discuss the problem again with an authorized Mercedes-Benz Center or, if necessary, contact us at one of the following addresses:

#### In the USA:

Mercedes-Benz USA, LLC  
Customer Assistance Center  
One Mercedes-Benz Drive  
Sandy Springs, GA 30328

#### In Canada:

Mercedes-Benz Canada, Inc.  
Customer Relations Department  
98 Vanderhoof Avenue  
Toronto, Ontario M4G 4C9

### Reporting safety defects

#### USA only:

The following text is published as required of manufacturers under Title 49, Code of U.S. Federal Regulations, Part 575 pursuant to the "National Traffic and Motor Vehicle Safety Act of 1966".

If you believe that your vehicle has a defect which could cause a crash or could cause injury or death, you should immediately inform the National Highway Traffic Safety Administration (NHTSA) in addition to notifying Mercedes-Benz USA, LLC.

If NHTSA receives similar complaints, it may open an investigation, and if it finds that a safety defect exists in a group of vehicles, it may order a recall and remedy campaign. However, NHTSA cannot become involved in individual problems between you, your dealer, or Mercedes-Benz USA, LLC.

To contact NHTSA, you may call the Vehicle Safety Hotline toll-free at 1-888-327-4236 (TTY: 1-800-424-9153); go to the <https://www.safercar.gov/>; or write to: Administrator, NHTSA, 400 Seventh Street, SW., Washington, DC 20590.; USA.

You can also obtain other information about motor vehicle safety from: <https://www.safercar.gov>

### Canada only:

The following text is published as required of manufacturers under subsection 18.4 (4) of the Motor Vehicle Safety Regulations.

If you believe that your vehicle has a defect which could cause a crash or could cause injury or death, you should immediately inform Transport Canada in addition to notifying Mercedes-Benz Canada Inc.

If Transport Canada received similar complaints, it may open an investigation, and if it finds that a safety defect exists in a group of vehicles, it may order a recall and remedy campaign. However, Transport Canada cannot become involved in individual problems between you, your dealer or Mercedes-Benz Canada Inc.

To contact Transport Canada, you may call the Defect Investigations and Recalls Division toll-free in Canada at 1-800-333-0510 or 819-994-3328 in the Gatineau-Ottawa area or internationally; you may also go to the following websites for more information:

- English: <https://www.tc.gc.ca/recalls>
- French: <https://www.tc.gc.ca/rappels>

### Limited Warranty

**!** **NOTE** Damage to the vehicle arising from violation of these operating instructions.

Damage to the vehicle can arise from violation of these operating instructions.

This damage is not covered either by the Mercedes-Benz implied warranty or by the New- or Used-Vehicle Warranty.

- ▶ Follow the instructions in these operating instructions on proper operation of your vehicle as well as on possible vehicle damage.

### QR code for rescue card

QR codes are attached in the fuel filler flap and on the opposite side on the B-pillar. In the event of an accident, rescue services can use the QR code to quickly find the appropriate rescue card for

your vehicle. The current rescue card contains the most important information about your vehicle in a compact form, e.g. the routing of the electric lines.

Further information can be obtained at <https://www.mercedes-benz.de/qr-code>.

### Data storage

#### Data processing in the vehicle

#### Electronic control units

Electronic control units are installed in your vehicle. Control units process data which, for example, they receive from vehicle sensors, generate themselves or exchange between themselves. Some control units are required for the safe operation of your vehicle, some assist you when driving, such as driver assistance systems, while others enable convenience or infotainment functions.

The following provides you with general information regarding data processing in the vehicle. Additional information regarding exactly which data in your vehicle are collected, saved and transmitted to third parties, and for what purpose,

can be found in the information directly related to the functional characteristics in question in their respective Operator's Manual. This information is also available online and, depending on the vehicle equipment, digitally.

### Personal data

Every vehicle is identified by a unique vehicle identification number. Depending on the country, this vehicle identification number can be used by, for example, governmental authorities to determine the identity of the owner. There are other possibilities to use data collected from the vehicle to identify the owner or driver, such as the license plate number.

Therefore, data generated or processed by control units may be attributable to a person or, under certain conditions, become attributable to a person. Depending on which vehicle data are available, it may be possible to make inferences about, for example, your driving behavior, your location, your route or your use patterns.

### Legal requirements regarding the disclosure of data

If legally required to do so, manufacturers are, in individual cases, legally obliged to provide governmental entities, upon request and to the extent required, data stored by the manufacturer. For example, this may be the case during the investigation of a criminal offense.

Governmental entities are themselves, in individual cases and within the applicable legal framework, authorized to read out data from the vehicle. In the case of an accident, information that can help with an investigation can, therefore, be taken from the airbag control unit, for example.

### Operational data in the vehicle

This is data regarding the operation of the vehicle, which have been processed by control units.

This includes the following data, for example:

- Vehicle status information such as the speed, longitudinal acceleration, lateral acceleration, number of wheel revolutions or the fastened seat belts display
- Ambient conditions, such as temperature, rain sensor or distance sensor

Generally, the use of these data is temporary; they will not be stored beyond the period of operation and will only be processed within the vehicle itself. Control units often contain data memories for vehicle keys, for example. Their use permits the temporary or permanent documentation of technical information about the vehicle's operating state, component loads, maintenance requirements and technical events or malfunctions.

Depending on the vehicle equipment, the following data are stored:

- Operating status of system components, such as fill levels, tire pressure or battery status
- Malfunctions or faults in important system components, such as lights or brakes
- System reactions in special driving situations, such as airbag deployment or the intervention of stability control systems
- Information on events leading to vehicle damage

In certain cases, it may be required to store data that would have otherwise been used only temporarily. This may be the case if the vehicle has detected a malfunction, for example.



If you use services, such as repair services and maintenance work, stored operational data as well as the vehicle identification number can be read out and used. They can be read out by service network employees, such as workshops and manufacturers or third parties, such as breakdown services. The same is true in the case of warranty claims and quality assurance measures.

In general, the readout is performed via the legally prescribed port for the diagnostics connection in the vehicle. The operational data that are read out document technical states of the vehicle or of individual components and assist in the diagnosis of malfunctions, compliance with warranty obligations and quality improvement. To that end, these data, in particular information about component loads, technical events, malfunctions and other faults may be transmitted along with the vehicle identification number to the manufacturer. Furthermore, the manufacturer is subject to product liability. For this reason the manufacturer also uses operational data from the vehicle, for example, for recalls. These data can also be used to examine the customer's warranty and guarantee claims.

Fault memories in the vehicle can be reset by a service outlet or at your request as part of repair or maintenance work.

### Convenience and infotainment functions

You can store convenience settings and individual settings in the vehicle and change or reset them at any time.

Depending on the vehicle equipment, this includes the following settings, for example:

- Seat and steering wheel positions
- Suspension and climate control settings
- Individual settings, such as interior lighting

Depending on the selected equipment, you can import data into vehicle infotainment functions yourself.

Depending on the vehicle equipment, this includes the following data, for example:

- Multimedia data, such as music, films or photos for playback in an integrated multimedia system

- Address book data for use in connection with an integrated hands-free system or an integrated navigation system
- Entered navigation destinations
- Data about the use of Internet services

These data for convenience and infotainment functions may be saved locally in the vehicle or they may be located on a device which you have connected to the vehicle, such as a smartphone, USB flash drive or MP3 player. If you have entered these data yourself, you can delete them at any time.

This data is transmitted from the vehicle to third parties only at your request. This applies, in particular, when you use online services in accordance with the settings that you have selected.

### Smartphone integration (e.g. Android Auto or Apple CarPlay®)

If your vehicle is accordingly equipped, you can connect your smartphone or another mobile end device to the vehicle. You can then control them by means of the control elements integrated in the vehicle. Images and audio from the smart-

phone can be output via the multimedia system. Certain information is simultaneously transferred to your smartphone. Depending on the type and integration, this includes position data, day/night mode and other general vehicle statuses. For more information please consult the Operator's Manual of the vehicle/infotainment system.

This integration allows the use of selected smartphone apps, such as navigation or music player apps. There is no further interaction between the smartphone and the vehicle; in particular, vehicle data is not directly accessible. The type of additional data processing is determined by the provider of the app being used. Which settings you can make, if any, depends on the specific app and the operating system of your smartphone.

### Online services

#### **Wireless network connection**

If your vehicle has a wireless network connection, it enables data to be exchanged between your vehicle and additional systems. The wireless network connection is made possible by the vehicle's own transmitter and receiver or by a mobile end

device that you have brought into the vehicle, for example, a smartphone. Online functions can be used via the wireless network connection. This includes online services and applications/apps provided to you by the manufacturer or by other providers.

#### **Manufacturer's services**

Regarding the manufacturer's online services, the individual functions are described by the manufacturer in a suitable place, for example, in the Operator's Manual or on the manufacturer's website, where the relevant data protection information is also given. Personal data may be used for the provision of online services. Data are exchanged via a secure connection, such as the manufacturer's designated IT systems. Any personal data which are collected, processed and used, other than for the provision of services, is done so exclusively on the basis of legal permission. This is the case, for example, for a legally prescribed emergency call system, a contractual agreement or when consent has been given.

You can have services and functions, some of which are subject to a fee, activated or deactiva-

ted. This excludes legally prescribed functions and services, such as an emergency call system.

#### **Third party services**

If you use online services from other providers (third parties), these services are the responsibility of the provider in question and subject to that provider's data protection conditions and terms of use. As a general rule, the manufacturer has no influence on the content exchanged.

For this reason, when services are provided by third parties, please ask the service provider in question for information about the type, extent and purpose of the collection and use of personal data.

### Data protection rights

Depending on your country or the equipment and range of functions of your vehicle as well as the services you use and the services on offer, you are entitled to different data protection rights. Further information on data protection and your data protection rights can either be found on the manufacturer's website or you will receive this information as part of the various services and

service offers. There you will also find the contact information for the manufacturer and its data protection officers.

At a workshop, for example, with the support of a specialist and possibly for a fee, you can have data read out which is stored only locally in the vehicle.

### MBUX multimedia system/Mercedes me connect

If the vehicle is equipped with the MBUX multimedia system or Mercedes me connect, additional data about the vehicle's operation, the use of the vehicle in certain situations, and the location of the vehicle may be compiled by the MBUX multimedia system or Mercedes me connect.

For additional information, please refer to the "MBUX multimedia system" section and/or the Mercedes me connect Terms and Conditions.

### Event data recorders

#### **USA only:**

This vehicle is equipped with an event data recorder (EDR). The main purpose of an EDR is to

record, in certain crash or near crash-like situations, such as an airbag deployment or hitting a road obstacle, data that will assist in understanding how a vehicle's systems performed. The EDR is designed to record data related to vehicle dynamics and safety systems for a short period of time, typically 30 seconds or less.

The EDR in this vehicle is designed to record such data as:

- How various systems in your vehicle were operating
- Whether or not the driver and front passenger seat belts were buckled/fastened
- How far (if at all) the driver was depressing the accelerator and/or brake pedal and
- How fast the vehicle was traveling

This data can help provide a better understanding of the circumstances in which accidents and injuries occur. NOTE: EDR data is recorded by your vehicle only if a non-trivial crash situation occurs; no data is recorded by the EDR under normal driving conditions and no personal data (e.g. name, gender, age and accident location) is recorded. However, other parties, such as law enforcement,

could combine EDR data with the type of personally identifying data routinely acquired during a crash investigation.

To read data recorded by an EDR, special equipment is required, and access to the vehicle or the EDR is needed. In addition to the vehicle manufacturer, other parties that have the special equipment, such as law enforcement, can read the information by accessing the vehicle or the EDR.

EDR data may be used in civil and criminal matters as a tool in accident reconstruction, accident claims and vehicle safety. Since the Crash Data Retrieval (CDR) tool that is used to extract data from the EDR is commercially available, Mercedes-Benz USA, LLC ("MBUSA") expressly disclaims any and all liability arising from the extraction of this information by unauthorized Mercedes-Benz personnel.

MBUSA will not share EDR data with others without the consent of the vehicle owner or, if the vehicle is leased, without the consent of the lessee. Exceptions to this representation include responses to subpoenas by law enforcement; by federal, state or local government; in connection with or arising out of litigation involving MBUSA or

its subsidiaries and affiliates; or, as required by law.

Warning: The EDR is a component of the Restraint System Module. Tampering with, altering, modifying or removing the EDR component may result in a malfunction of the Restraint System Module and other systems.

State laws or regulations regarding EDRs that conflict with federal regulation are pre-empted. This means that in the event of such conflict, the federal regulation governs. As of December 2016, 17 states have enacted laws relating to EDRs.

### Copyright

#### Free and open source software

---

Information on license for free and open-source software used in your vehicle can be found on the data carrier in your vehicle document wallet and with updates on the following website:

<https://www.mercedes-benz.com/opensource>

#### Registered trademarks

---

- Bluetooth® is a registered trademark of Bluetooth SIG, Inc.
- DTS™ is a registered trademark of DTS, Inc.
- Dolby® and MLP™ are registered trademarks of DOLBY Laboratories.
- ESP® and PRE-SAFE® are registered trademarks of Daimler AG.
- HomeLink® is a registered trademark of Genex Corporation.
- iPod® and iTunes® are registered trademarks of Apple Inc.
- Burmester® is a registered trademark of Burmester Audiosysteme GmbH.
- Microsoft® and Windows Media® are registered trademarks of Microsoft Corporation.
- SIRIUS® is a registered trademark of Sirius XM Radio Inc.
- HD Radio™ is a registered trademark of iBiquity Digital Corporation.
- Gracenote® is a registered trademark of Gracenote, Inc.
- ZAGAT Survey® and related brands are registered trademarks of Zagat Survey, LLC.

## Restraint system

### Protection provided by the restraint system

The restraint system includes the following components:

- Seat belt system
- Airbags
- Child restraint system
- Child seat securing systems

The restraint system can help prevent the vehicle occupants from coming into contact with parts of the vehicle interior in the event of an accident. In the event of an accident, the restraint system can also reduce the forces to which the vehicle occupants are subjected.

A seat belt can only provide the best level of protection if it is worn correctly. Depending on the detected accident situation, Emergency Tensioning Devices and/or airbags supplement the protection offered by a correctly worn seat belt. Emergency Tensioning Devices and/or airbags are not deployed in every accident.

In order for the restraint system to provide the intended level of protection, each vehicle occupant must observe the following information:

- Fasten seat belts correctly.
- Sit in an almost upright seat position with their back against the seat backrest.
- Sit with their feet resting on the floor, if possible.
- Always secure persons under 5 ft (1.50 m) tall in an additional restraint system suitable for Mercedes-Benz vehicles.

However, no system available today can completely eliminate injuries and fatalities in every accident situation. In particular, the seat belt and airbag generally do not protect against objects penetrating the vehicle from the outside. It is also not possible to completely rule out the risk of injury caused by the airbag deploying.

### Reduced restraint system protection

**⚠ WARNING** Risk of injury or death due to modifications to the restraint system

Vehicle occupants may no longer be protected as intended if alterations are made to the restraint system.

- ▶ Never alter the parts of the restraint system.
- ▶ Never tamper with the wiring or any electronic component parts or their software.

If it is necessary to modify the vehicle to accommodate a person with disabilities, contact an authorized Mercedes-Benz Center for details.

USA only: for details, contact our Customer Assistance Center on 1-800-FOR-MERCEdes (1-800-367-6372).



### Restraint system functionality

When the vehicle is switched on, a self-test is performed, during which the  restraint system

warning lamp lights up. It goes out no later than a few seconds after the vehicle is started. The components of the restraint system are then functional.

### Malfunctioning restraint system

A malfunction has occurred in the restraint system if:

- The  restraint system warning lamp does not light up when the vehicle is switched on
- The  restraint system warning lamp lights up continuously or repeatedly during a journey

**⚠ WARNING** Risk of injury due to malfunctions in the restraint system

Components in the restraint system may be activated unintentionally or not deploy as planned in an accident.

- ▶ Have the restraint system checked and repaired immediately at a qualified specialist workshop.

### Function of the restraint system in an accident

How the restraint system works is determined by the severity of the impact detected and the type of accident anticipated:

- Frontal impact
- Rear impact
- Side impact
- Rollover

The activation thresholds for the components of the restraint system are determined based on the evaluation of the sensor values measured at various points in the vehicle. This process is pre-emptive in nature. The triggering/deployment of the components of the restraint system must take place in good time at the start of the collision.

Factors which can only be seen and measured after a collision has occurred do not play a decisive role in the deployment of an airbag. Nor do they provide an indication of airbag deployment.

The vehicle may be deformed significantly without an airbag being deployed. This is the case if only parts which are relatively easily deformed are affected and the rate of vehicle deceleration is

not high. Conversely, an airbag may be deployed even though the vehicle suffers only minor deformation. If very rigid vehicle parts such as longitudinal members are hit, this may result in sufficiently high levels of vehicle deceleration.

Depending on the detected deployment situation, the components of the restraint system can be activated or deployed independently of each other:

- Emergency Tensioning Device: frontal impact, rear impact, side impact, rollover
- Driver's airbag, front passenger airbag: frontal impact
- Knee airbag: frontal impact
- Side airbag: side impact
- Window curtain airbag: side impact, rollover, frontal impact
- PRE-SAFE® Impulse Side: side impact

The front passenger airbag can only be deployed in an accident if the PASSENGER AIR BAG OFF indicator lamp is off. If the front passenger seat is occupied, make sure, both before and during the

journey, that the status of the front passenger air-bag is correct (→ page 43).

**⚠ WARNING** Risk of burns from hot air bag components

The air bag parts are hot after an air bag has been deployed.

- ▶ Do not touch the air bag parts.
- ▶ Have a deployed air bag replaced at a qualified specialist workshop as soon as possible.

Mercedes-Benz recommends that you have the vehicle towed to a qualified specialist workshop after an accident. Take this into account, particularly if an Emergency Tensioning Device is triggered or an airbag deployed.

If the Emergency Tensioning Devices are triggered or an airbag is deployed, you will hear a bang, and a small amount of powder may also be released:

- The bang will not generally affect your hearing.
- In general, the powder released is not hazardous to health but may cause short-term

breathing difficulties to persons suffering from asthma or other pulmonary conditions.

Provided it is safe to do so, leave the vehicle immediately or open the window in order to prevent breathing difficulties.

Airbags and pyrotechnic Emergency Tensioning Devices contain perchlorate material, which may require special handling or environmental protection measures. National guidelines regarding waste disposal must be observed. In California, see <https://dtsc.ca.gov/>. Using the search function, you will find information on perchlorate, for example.

### Seat belts

#### Protection provided by the seat belt

Always fasten your seat belt correctly before starting a journey. A seat belt can only provide the best level of protection if it is worn correctly.

**⚠ WARNING** Risk of injury or death due to incorrectly fastened seat belt

If the seat belt is not worn correctly, it cannot perform its intended protective function.

In addition, an incorrectly fastened seat belt can also cause injuries, for example, in the event of an accident or when braking or changing direction suddenly.

- ▶ Always ensure that all vehicle occupants have their seat belts fastened correctly and are sitting properly.

Always observe the instructions about the correct driver's seat position and adjusting the seat (→ page 84).

In order for the correctly worn seat belt to provide the intended level of protection, each vehicle occupant must observe the following information:

- The seat belt must not be twisted and must fit tightly and snugly across the body.
- The seat belt must be routed across the center of the shoulder and as low down across the hips as possible.

- The shoulder section of the seat belt should not touch your neck nor be routed under your arm or behind your back.
- Avoid wearing bulky clothing, e.g. a winter coat.
- Push the lap belt down as far as possible across your hips and pull tight with the shoulder section of the belt. Never route the lap belt across your abdomen.  
Pregnant women must also take particular care with this.
- Never route the seat belt across sharp, pointed, abrasive or fragile objects.
- Only one person should use each seat belt at any one time. Never allow babies and children to travel sitting on the lap of another vehicle occupant.
- Never secure objects with a seat belt if the seat belt is also being used by one of the vehicle's occupants. Always observe the instructions for loading the vehicle when securing objects, luggage or loads (→ page 97).

Also ensure that no objects, e.g. a cushion, are ever placed between a person and the seat.

The seat belts on the following seats are equipped with a special seat belt retractor:

- Front passenger seat
- Rear seats

Activate or deactivate the special seatbelt retractor (→ page 51).

If children are traveling in the vehicle, be sure to observe the instructions and safety notes on "Children in the vehicle" (→ page 48).

#### Limitations of the protection provided by the seat belt

- ▲ **WARNING** Risk of injury or death due to an incorrect seat position

The seat belt does not offer the intended level of protection if you have not moved the seat backrest to an almost vertical position.

In particular, you could slip beneath the seat-belt and become injured.

- ▶ Adjust the seat properly before beginning your journey.
- ▶ Always ensure that the seat backrest is in an almost vertical position and that the shoulder belt is routed across the center of your shoulder.

- ▲ **WARNING** Risk of injury or death when additional restraint systems are not used for persons with a smaller stature

Persons under 5 ft (1.50 m) tall cannot wear the seat belt correctly without a suitable additional restraint system.

- ▶ Always secure persons under 5 ft (1.50 m) tall in a suitable restraint system.



**⚠ WARNING** Danger of injury or death due to blocked seat belt anchorage

The restraint effect of the seat belt is impaired if objects between the front seat and the door are blocking the movable seat belt anchorage on the front seat.

- ▶ Before starting a journey, make sure that there are no objects between the front seat and the door.

**⚠ WARNING** Risk of injury or death due to damaged or modified seat belts

Seat belts cannot provide protection in the following situations:

- The seat belt is damaged, has been modified, is extremely dirty, bleached or dyed
- The seat belt buckle is damaged or extremely dirty
- Modifications have been made to the Emergency Tensioning Device, seat belt anchorage or seat belt retractor

Seat belts may sustain non-visible damage in an accident, e.g. due to glass splinters.

Modified or damaged seat belts could tear or fail in the event of an accident, for example.

Modified Emergency Tensioning Devices could accidentally trigger or fail to function as intended.

- ▶ Never modify the seat belt system, for example the seat belt, seat belt buckle, Emergency Tensioning Device, seat belt anchorage and seat belt retractor.
- ▶ Make sure that the seat belts are undamaged, not worn and clean.
- ▶ Always have the seat belts checked immediately after an accident at a qualified specialist workshop.

Only use seat belts which have been approved for your vehicle by Mercedes-Benz.

**⚠ WARNING** Risk of injury or death from deployed pyrotechnic Emergency Tensioning Devices

Pyrotechnic Emergency Tensioning Devices that have been deployed are no longer operational and are unable to perform their intended protective function.

- ▶ Therefore, have deployed pyrotechnic Emergency Tensioning Devices immediately replaced at a qualified specialist workshop.

Mercedes-Benz recommends that you have the vehicle towed to a qualified specialist workshop after an accident.

**! NOTE** Damage caused by trapping the seat belt

If an unused seat belt is not fully retracted, it may become trapped in the door or in the seat mechanism.

- ▶ Always ensure that an unused seat belt is fully retracted.

### Fastening and adjusting seat belts

If the seat belt is pulled quickly or sharply, the seat belt retractor locks. The seat belt strap cannot be pulled out any further.

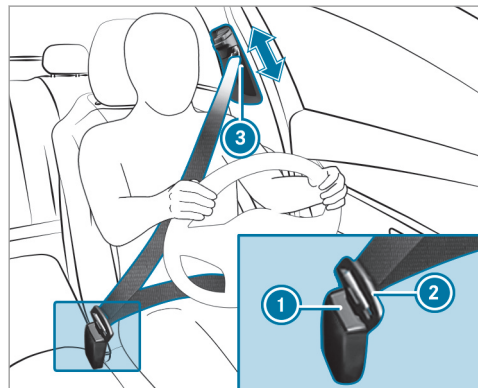

- ▶ Always engage seat belt tongue ② of the seat belt into seat belt buckle ① of the corresponding seat.

- ▶ **To adjust the seat belt height:** press and hold the belt guide release and slide seat belt outlet ③ into the desired position.

- ▶ **To engage the seat belt outlet:** let go of the belt guide release and ensure that seat belt outlet ③ locks into position.

- ⓘ A seat belt can only provide the best level of protection if it is worn correctly. Observe the notes on fastening the seat belt (→ page 35).

**!** **NOTE** Deployment of components of the restraint system when the front passenger seat is unoccupied and a seat belt is buckled

When the front passenger seat is unoccupied and the seat belt tongue of the seat belt is engaged in the seat belt buckle, components of the restraint system may deploy unnecessarily on the front passenger side, e.g. the Emergency Tensioning Device.

- ▶ Only buckle the seat belts as intended.

- ⓘ Observe the notes on stowage areas (→ page 97).

Information on installing a child restraint system and on children traveling in the vehicle can be found in the "Children in the vehicle" section (→ page 51).

### Seat belt adjustment function

**Vehicles with PRE-SAFE®:** After a front seat belt has been fastened, the automatic seat belt adjustment may apply a certain tightening force. Do not hold the seat belt tightly while it is adjusting.

You can activate and deactivate the seat belt adjustment function using the multimedia system (→ page 38).

### Activating/deactivating seat belt adjustment via the multimedia system

Multimedia system:

➔ ▶▶ Settings ▶▶ Vehicle

- ▶ Activate or deactivate **Belt Adjustment**.

### Releasing seat belts

- ▶ Press the release button in the seat belt buckle and guide the seat belt back with the seat belt tongue.

### Seat belt warning function for the driver and front passenger

The  seat belt warning lamp in the Instrument Display is a reminder that all vehicle occupants must wear their seat belts correctly.

The  seat belt warning lamp lights up for six seconds every time the vehicle is started.

In addition, a warning tone may sound.

When the driver's and front passenger's doors are closed and the driver and front passenger have fastened their seat belts, the seat belt warning goes out.

In the following cases, the seat belt warning lights up during a journey if:

- The vehicle speed exceeds 15 mph (25 km/h) and the driver's or front passenger seat belt is not fastened.

- The driver or front passenger unfastens their seat belt while the vehicle is in motion.

### Airbags

#### Overview of airbags

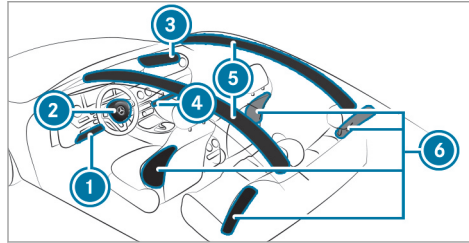

- ① Driver's knee airbag
- ② Driver's airbag
- ③ Front passenger airbag
- ④ Front passenger knee airbag
- ⑤ Window curtain airbag
- ⑥ Side airbag

The installation location of an airbag is identified by the AIRBAG symbol.

When enabled, an airbag can provide additional protection for the respective vehicle occupant.

Potential protection provided by each airbag:

- Knee airbag: thigh, knee and lower leg
- Driver's airbag, front passenger airbag: head and ribcage
- Window curtain airbag: head
- Side airbag: ribcage, also pelvis for front seat occupants

**⚠ WARNING** Risk of injury or death if the co-driver airbag is enabled

If the co-driver airbag is enabled, a child on the co-driver seat may be struck by the co-driver airbag during an accident.

NEVER use a rearward-facing child restraint system on a seat with an ENABLED FRONT AIRBAG; DEATH or SERIOUS INJURY to the CHILD can occur.

When installing a child restraint system on the front passenger seat, observe the vehicle-specific information (→ page 57). Also, always observe the notes on rearward-facing or forward-facing child restraint systems on the front passenger seat (→ page 56).

#### Information on automatic front passenger airbag shutoff

The front passenger airbag can only be deployed in an accident if the PASSENGER AIR BAG OFF indicator lamp is off. If the front passenger seat is occupied, make sure, both before and during the journey, that the status of the front passenger airbag is correct (→ page 43).

**!** **NOTE** Deployment of components of the restraint system when the front passenger seat is unoccupied

In an accident, the components of the restraint system may deploy unnecessarily on the front passenger side if:

- There are heavy objects on the front passenger seat.

- The seat belt tongue is engaged in the seat belt buckle of the front passenger seat and the front passenger seat is unoccupied.

- ▶ Store objects in a suitable place.
- ▶ Only one person should use each seat belt at any one time.

Depending on the detected accident situation, the window curtain airbag on the front passenger side may deploy. The airbag is deployed regardless of whether the front passenger seat is occupied.

#### Protective capacity of the airbags

Depending on the accident situation, an airbag may supplement the protection offered by a correctly fastened seat belt.

**⚠** **WARNING** Risk of injury or death due to an incorrect seat position

If you deviate from the correct seat position, the airbag cannot perform its intended protective function.

Each vehicle occupant must make sure of the following:

- Fasten seat belts correctly. Pregnant women must take particular care to ensure that the lap belt never lies across the abdomen.
- Adopt the correct seat position and keep as far away as possible from the airbags.
- Observe the following information.
- ▶ Always make sure that there are no objects between the airbag and vehicle occupant.

To avoid the risks resulting from the deployment of an airbag, each vehicle occupant must observe the following information in particular:

- Before starting your journey, adjust your seat correctly; the driver's seat and front passenger seat should be moved as far back as possible.

When doing so, always observe the information on the correct driver's seat position (→ page 84).

- Only hold the steering wheel by the steering wheel rim. This allows the airbag to be fully deployed.
- Always lean against the seat backrest when the vehicle is in motion. Do not lean forwards or against the door or side window. You may otherwise be in the deployment area of the airbags.
- The occupants must always keep their feet on the floor. Do not put your feet on the cockpit, for example. Your feet may otherwise be in the deployment area of the airbag.
- If children are traveling in the vehicle, observe the additional notes (→ page 48).
- Always store and secure objects correctly.

Objects in the vehicle interior may prevent an airbag from functioning correctly. Each vehicle occupant must always make sure of the following in particular:

- There are no people, animals or objects between the vehicle occupants and an airbag.
- There are no objects between the seat, door and door pillar (B-pillar).

- There are no hard objects, e.g. coat hangers, hanging on the grab handles or coat hooks.
- There are no accessory parts, such as mobile navigation devices, mobile phones or cup holders, within the deployment area of an airbag, e.g. on the cockpit, on the door, on the side window or on the side trim.  
In addition, no connecting cables, tensioning straps or retaining straps must be routed or attached to the vehicle within the deployment area of an airbag. Always comply with the accessory manufacturer's installation instructions and, in particular, the notes on suitable places for installation.
- There are no heavy, sharp-edged or fragile objects in the pockets of your clothing. Store such objects in a suitable place.

### Limitations of the protection provided by airbags

**⚠ WARNING** Risk of injury due to modifications to the cover of an airbag

If you modify the cover of an airbag or affix objects such as stickers to it, the airbag may no longer function correctly.

- ▶ Never modify the cover of an airbag and do not affix objects to it.

The installation location of an airbag is identified by the AIRBAG symbol (→ page 39).

**⚠ WARNING** Risk of injury or death due to the use of unsuitable seat covers

Due to unsuitable seat covers, the airbags cannot protect vehicle occupants as intended.

In addition, the operation of the automatic front passenger airbag shutoff could be restricted.

- ▶ You should only use seat covers that have been approved for the corresponding seats by Mercedes-Benz.

**⚠ WARNING** Risk of injury due to malfunctioning sensors in the door

The function of the airbags can be impaired due to modifications or incorrect work performed on the doors or door trim, or if the doors are damaged.

- ▶ Never modify the doors or parts of the doors.
- ▶ Always have work on the doors or door trim carried out at a qualified specialist workshop.

**⚠ WARNING** Risk of injury due to deployed airbag

A deployed airbag no longer offers any protection.

- ▶ Have the vehicle towed to a qualified specialist workshop in order to have the deployed airbag replaced.

Have deployed airbags replaced immediately.

**Status of the front passenger front airbag**

**Function of the automatic front passenger airbag shutoff**

The automatic front passenger airbag shutoff is able to detect whether the front passenger seat is occupied by a person or a child restraint system. The front passenger airbag and front passenger knee airbag are enabled or disabled accordingly.

**⚠ WARNING** Risk of injury or death due to objects under the co-driver seat

Objects trapped under the co-driver seat can interfere with the function of the automatic co-driver airbag shutoff or damage the system.

- ▶ Do not store any objects under the co-driver seat.
- ▶ When the co-driver seat is occupied, make sure that no objects are trapped under the co-driver seat.

When installing a child restraint system on the front passenger seat, observe the vehicle-specific information (→ page 57). Also, always observe the notes on rearward-facing or forward-facing

child restraint systems on the front passenger seat (→ page 56).

A person on the front passenger seat must observe the following information:

- Fasten seat belts correctly (→ page 35).
- Sit in an almost upright seat position with their back against the seat backrest.
- Sit with their feet resting on the floor, if possible.

The front passenger airbag may otherwise be disabled by mistake, for example, in the following situations:

- The front passenger transfers their weight by supporting themselves on a vehicle armrest.
- The front passenger sits in such a way that their weight is raised from the seat surface.

**⚠ WARNING** Risk of injury or death due to a disabled front passenger airbag

The front passenger airbag is disabled when the PASSENGER AIR BAG OFF indicator lamp is lit.

A person in the front passenger seat could then, for example, come into contact with the vehicle interior, especially if the person is sitting too close to the cockpit.

If the front passenger seat is occupied, always ensure that:

- The classification of the person in the front passenger seat is correct and the front passenger airbag is enabled or disabled in accordance with the person in the front passenger seat.
  - The front passenger seat has been moved as far back as possible.
  - The person is seated correctly.
- ▶ Both before and during the journey, ensure that the status of the front passenger airbag is correct.

If the front passenger seat is occupied, the classification of the person or child restraint system on the front passenger seat takes place after the front passenger airbag shutoff self-test. The PASSENGER AIR BAG indicator lamps display the status of the front passenger airbag.

Always observe the notes on the function of the PASSENGER AIR BAG indicator lamps (→ page 43).

#### Function of the PASSENGER AIR BAG indicator lamps

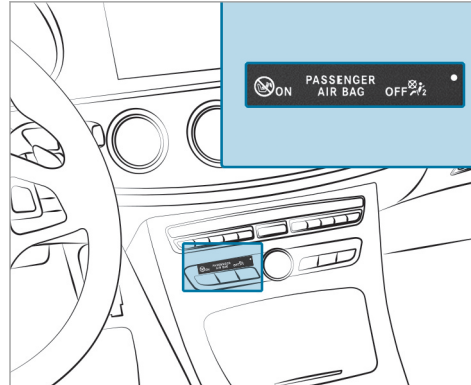

#### Self-test of automatic front passenger airbag shut-off

When the vehicle is switched on, a self-test is performed during which the two PASSENGER AIR BAG ON and OFF indicator lamps light up simultaneously.

The status of the front passenger airbag is displayed via the PASSENGER AIR BAG indicator lamps after the self-test:

- **ON is lit:** the front passenger airbag may deploy during an accident.  
The indicator lamp goes out after 60 seconds.
- **ON and OFF are not lit:** the front passenger airbag may deploy during an accident.
- **OFF is lit:** the front passenger airbag is disabled. It will then not be deployed in the event of an accident.

If the PASSENGER AIR BAG ON indicator lamp is off, only the PASSENGER AIR BAG OFF indicator lamp shows the status of the front passenger airbag. The PASSENGER AIR BAG OFF indicator lamp may be lit continuously or be off.

If the PASSENGER AIR BAG OFF indicator lamp and the  restraint system warning lamp light up simultaneously, the front passenger seat may not be used. Also in this case, do not install a child restraint system on the front passenger seat. Have the automatic front passenger airbag shutoff checked and repaired immediately at a qualified specialist workshop.

#### Status display

If the front passenger seat is occupied, ensure, both before and during the journey, that the status of the front passenger airbag is correct for the current situation.

**After installing a rearward-facing child restraint system on the front passenger seat:** PASSENGER AIR BAG OFF must be lit continuously.

**⚠ WARNING** Risk of injury or fatal injury when using a rearward-facing child restraint system while the co-driver airbag is enabled

If you secure a child in a rearward-facing child restraint system on the co-driver seat and the PASSENGER AIR BAG OFF indicator lamp is

off, the co-driver airbag can deploy in the event of an accident.

The child could be struck by the airbag.

- ▶ Always ensure that the co-driver airbag is disabled. The PASSENGER AIR BAG OFF indicator lamp must be lit.
- ▶ NEVER use a rearward-facing child restraint system on a seat with an ENABLED FRONT AIRBAG; DEATH or SERIOUS INJURY to the CHILD can occur.

When installing a child restraint system on the front passenger seat, observe the vehicle-specific information (→ page 56).

Depending on the child restraint system and the stature of the child, the PASSENGER AIR BAG OFF indicator lamp may be off. In this case, do not install the rearward-facing child restraint system on the front passenger seat.

Instead, install the rearward-facing child restraint system on a suitable rear seat.

**After installing a forward-facing child restraint system on the front passenger seat:** depending on the child restraint system and the stature of the

child, PASSENGER AIR BAG OFF may be lit continuously or be off. Always observe the following information.

**⚠ WARNING** Risk of injury or death due to incorrect positioning of the forward-facing child restraint system

If you secure a child in a forward-facing child restraint system on the front passenger seat that is positioned too close to the cockpit, in the event of an accident, the child could:

- come into contact with the vehicle interior if the PASSENGER AIR BAG OFF indicator lamp is lit, for example
  - be struck by the airbag if the PASSENGER AIR BAG OFF indicator lamp is off.
- ▶ Always move the front passenger seat as far back as possible and fully retract the seat cushion length adjustment. While doing so, always make sure that the shoulder belt strap is correctly routed from the seat belt outlet of the vehicle to the shoulder belt guide on the child restraint system. The shoulder belt strap



must be routed forwards and downwards from the seat belt outlet. If necessary, adjust the seat belt outlet and the front passenger seat accordingly.

- ▶ Always comply with the child restraint system manufacturer's installation instructions.

When installing a child restraint system on the front passenger seat, observe the vehicle-specific information (→ page 56).

**If a person is sitting on the front passenger seat:** PASSENGER AIR BAG OFF may be lit continuously or be off, depending on the person's stature.

A person on the front passenger seat must always observe the following information:

- If the front passenger seat is occupied by an adult or a person with a stature corresponding to that of an adult, the PASSENGER AIR BAG OFF indicator lamp must be off. This indicates that the front passenger airbag is enabled.  
If the PASSENGER AIR BAG OFF indicator lamp is lit continuously, an adult or person

with a build corresponding to that of an adult must not use the front passenger seat.

Instead, they should use a rear seat.

- If the front passenger seat is occupied by a person of smaller stature (e.g. a teenager or small adult), the PASSENGER AIR BAG OFF indicator lamp is either lit continuously or remains off, depending on the classification.
  - If the PASSENGER AIR BAG OFF indicator lamp is off: move the front passenger seat as far back as possible, or the person of smaller stature should use a rear seat.
  - If the PASSENGER AIR BAG OFF indicator lamp is lit continuously: the person of smaller stature should not use the front passenger seat.

**⚠ WARNING** Risk of injury or death when the PASSENGER AIR BAG OFF indicator lamp is lit

If the PASSENGER AIR BAG OFF indicator lamp remains lit after the self-test, the front passenger airbag is disabled.

If the front passenger seat is occupied, always ensure that:

- The classification of the person in the front passenger seat is correct and the front passenger airbag is enabled or disabled in accordance with the person in the front passenger seat.
- The person is seated properly with a correctly fastened seat belt.
- The front passenger seat has been moved as far back as possible.

Be sure to also observe the following further related subjects:

- Child restraint system on the front passenger seat (→ page 56)

## PRE-SAFE® system

### Function of PRE-SAFE® (anticipatory occupant protection)

PRE-SAFE® is able to detect certain critical driving situations and implement pre-emptive measures to protect the vehicle occupants.

PRE-SAFE® can implement the following measures independently of each other:

- Tightening the seat belts on the driver's seat and front passenger seat.
- Closing the side windows.
- **Vehicles with sliding sunroof:** Closing the sliding sunroof.
- **Vehicles with memory function:** Moving the front passenger seat to a more favourable seat position.
- **Vehicles with multicontour seat:** Increasing the air pressure in the seat side bolsters of the seat backrest.
- PRE-SAFE® Sound: provided that the multimedia system is switched on, generating a brief

noise signal to stimulate the innate protective mechanism of a person's hearing.

**!** **NOTE** Damage caused by objects in the footwell or behind the seat

The automatic adjustment of the seat position may result in damage to the seat and/or the object.

▶ Stow objects in a suitable place.

### Reversing the PRE-SAFE® system measures

If an accident did not occur, the pre-emptive measures that were taken are reversed.

You will need to perform certain settings yourself.

- ▶ If the seat belt pre-tensioning is not reduced, move the seat backrest back slightly. The locking mechanism releases.

### Function of PRE-SAFE® PLUS (anticipatory occupant protection plus)

PRE-SAFE® PLUS can detect certain impacts, particularly an imminent rear impact, and take pre-

emptive measures to protect the vehicle occupants. These measures cannot necessarily prevent an imminent impact.

PRE-SAFE® PLUS can implement the following measures independently of each other:

- Tightening the seat belts on the driver's seat and front passenger seat.
- Increasing brake pressure when the vehicle is stationary. This brake application is canceled automatically when the vehicle pulls away.

If an accident did not occur, the pre-emptive measures that were taken are reversed.

### System limits

The system will not initiate any action in the following situations:

- When backing up

The system will not initiate any braking application in the following situations:

- Whilst driving
- or

- When entering or exiting a parking space while using Active Parking Assist

### Function of PRE-SAFE® Impulse Side

If an imminent side impact is detected, PRE-SAFE® Impulse Side can pre-emptively move the front seat vehicle occupant's upper body towards the center of the vehicle. It does this by rapidly inflating an air cushion in the outer seat side bolster of the seat backrest on the side on which the impact is anticipated. This increases the distance between the door and the vehicle occupant.

If PRE-SAFE® Impulse Side has been deployed or is faulty, the **PRE-SAFE Impulse Side Inoperative** See Operator's Manual (→ page 346) display message appears.

### Safely transporting children in the vehicle

#### Always observe when children are traveling in the vehicle

- i** Also strictly observe the safety notes for the specific situation. In this way you can recog-

nize potential risks and avoid dangers if children are traveling in the vehicle (→ page 48).

#### Be diligent

Bear in mind that negligence when securing a child in the child restraint system may have serious consequences. Always be diligent in securing a child carefully before every journey.

Never allow babies and children to travel sitting on the lap of another vehicle occupant.

To improve protection for children younger than 12 years old or under 5 ft (1.50 m) in height, Mercedes-Benz recommends you observe the following information:

- Always secure the child in a child restraint system suitable for this Mercedes-Benz vehicle.
- The child restraint system must be appropriate to the age, weight and size of the child.
- The vehicle seat must be suitable for installing a child restraint system.

Accident statistics show that children secured on the rear seats are generally safer than children secured on the front seats. For this reason,

Mercedes-Benz strongly advises that you install a child restraint system on a rear seat.

#### The generic term child restraint system

The generic term child restraint system is used in this Operator's Manual. A child restraint system is, for example:

- A baby car seat
  - A rearward-facing child seat
  - A forward-facing child seat
  - A child booster seat with a backrest and seat belt guide
- Mercedes-Benz recommends using a child booster seat with a backrest.

The child restraint system must be appropriate to the age, weight and size of the child.

#### Observe laws and legal requirements

Always observe the legal requirements when using a child restraint system in the vehicle.

### Observe standards for child restraint systems

All child restraint systems must meet the following standards:

- U.S. Federal Motor Vehicle Safety Standards 213 and 225
- Canadian Motor Vehicle Safety Standards 213 and 210.2

Confirmation that the child restraint system complies with the standards can be found on an instruction label on the child restraint system. This confirmation can also be found in the installation instructions that are included with the child restraint system.

### Detecting risks, avoiding danger

#### Securing systems for child restraint systems in the vehicle

Only use the following securing systems for child restraint systems:

- The LATCH-type (ISOFIX) securing rings
- The vehicle's seat belt system
- The Top Tether anchorages

Installing an LATCH-type (ISOFIX) child restraint system is preferred.

Simply attaching to the securing rings on the vehicle can reduce the risk of installing the child restraint system incorrectly.

When securing a child with the integrated seat belt of the LATCH-type (ISOFIX) child restraint system, always comply with the permissible gross weight for the child and child restraint system (→ page 52).

A booster seat may be necessary to achieve proper seat belt positioning for children over 40 lbs (18 kg) in weight or until they reach a height where a three-point seat belt can be fastened properly without a booster seat.

Mercedes-Benz recommends a suitable child booster seat with a backrest and seat belt guide.

#### Advantage of a rearward-facing child restraint system

It is preferable to transport a baby or a small child in a suitable rearward-facing child restraint system. In this case, the child sits in the opposite direction to the direction of travel and faces backwards.

Babies and small children have comparatively weak neck muscles in relation to the size and weight of their head. The risk of injury to the cervical spine during an accident can be reduced in a rearward-facing child restraint system.

#### Always secure a child restraint system correctly

**▲ WARNING** Risk of injury or death due to incorrect installation of the child restraint system

The child can then not be protected or restrained as intended.

- ▶ Be sure to comply with the manufacturer's installation instructions for the child restraint system and its correct use.
- ▶ Make sure that the entire base of the child restraint system always rests on the sitting surface of the seat.
- ▶ Never place objects (e.g. cushions) under or behind the child restraint system.
- ▶ Use child restraint systems only with the original cover designed for them.

- ▶ Always replace damaged covers with genuine covers.

**⚠ WARNING** Risk of injury or death due to unsecured child restraint systems in the vehicle

If the child restraint system is incorrectly installed or not secured, it can come loose.

The child restraint system could be flung around and hit vehicle occupants.

- ▶ Always install child restraint systems correctly, even when not in use.
- ▶ Always comply with the child restraint system manufacturer's installation instructions.

- Always observe the child restraint system manufacturer's installation and operating instructions as well as the vehicle-specific information:
  - Installing the LATCH-type (ISOFIX) child restraint system on the right and left rear seats (→ page 52).

- Securing the child restraint system with the seat belt on the rear seat (→ page 55).
- Securing the child restraint system with the seat belt on the front passenger seat (→ page 57). Observe the specific instructions for the rearward-facing and forward-facing child restraint systems (→ page 56).

If the front passenger seat is occupied, ensure, both before and during the journey, that the status of the front passenger airbag is correct for the current situation (→ page 43).

- Observe the warning labels in the vehicle interior and on the child restraint system.
- Also secure Top Tether if present.

### Do not modify the child restraint system

**⚠ WARNING** Risk of injury due to modifications to the child restraint system

The child restraint system can no longer function properly. This poses an increased risk of injury.

- ▶ Never modify a child restraint system.
- ▶ Only affix accessories which have been specially approved for this child restraint system by the child restraint system's manufacturer.

### Only use child restraint systems which are in proper working condition

**⚠ WARNING** Risk of injury or death caused by the use of damaged child restraint systems

Child restraint systems or their retaining systems that have been subjected to stress in an accident may not be able to perform their intended protective function.

It may be the case that the child cannot be properly restrained.

- ▶ Always immediately replace child restraint systems that have been damaged or involved in an accident.
- ▶ Have the securing systems for the child restraint systems checked at a qualified specialist workshop before installing a child restraint system again.

#### Avoid direct sunlight

**⚠ WARNING** Risk of burns when the child seat is exposed to direct sunlight

If the child restraint system is exposed to direct sunlight or heat, parts could heat up excessively.

Children could suffer burns from these parts, particularly the metallic parts of the child restraint system.

- ▶ Always make sure that the child restraint system is not exposed to direct sunlight.

- ▶ Cover the child restraint system with a blanket, for example.
- ▶ If the child restraint system has been exposed to direct sunlight, allow it to cool before securing a child into it.
- ▶ Never leave children unattended in the vehicle.

#### Observe when stopping or parking

**⚠ WARNING** Risk of accident and injury due to children left unattended in the vehicle

If children are left unsupervised in the vehicle, they could, in particular:

- open doors, thereby endangering other persons or road users.
- get out and be struck by oncoming traffic.
- operate vehicle equipment and become trapped, for example.

In addition, the children could also set the vehicle in motion, for example by:

- releasing the parking brake.
- changing the transmission position.
- starting the vehicle.
- ▶ Never leave children unattended in the vehicle.
- ▶ When leaving the vehicle, always take the SmartKey with you and lock the vehicle.
- ▶ Keep the vehicle SmartKey out of reach of children.

**⚠ WARNING** Danger to life due to exposure to extreme heat or cold in the vehicle



If people, particularly children, are exposed to extreme temperatures over an extended period of time, there is a risk of serious injury or danger to life.

- ▶ Never leave persons, children in particular, unattended in the vehicle.

## Overview of suitable seats in the vehicle for installing a child restraint system

### Left/right rear seat

Preferred securing system:

-  LATCH-type (ISOFIX) child seat securing system
-  Also secure Top Tether if present (→ page 54).

Alternative securing system:

-  Vehicle seat belt

Also secure Top Tether if present (→ page 54).

### Front passenger seat

Securing system:

-  Vehicle seat belt



Be sure to observe:

- If the front passenger seat is occupied, ensure, both before and during the journey, that the status of the front passenger airbag is correct for the current situation (→ page 43).

- Notes on automatic front passenger airbag shutoff (→ page 42).

### Center rear seat

Securing system:

-  Vehicle seat belt
-  Also secure Top Tether if present (→ page 54).

## Activating or deactivating the special seat belt retractor of the seat belt

**⚠ WARNING** Risk of injury or death if a seat belt is unfastened while the vehicle is in motion

If the seat belt is released while the vehicle is in motion, the special seat belt retractor is deactivated and the child restraint system is no longer correctly secured. The seat belt is drawn in slightly by the inertia reel and cannot be immediately closed again.

- ▶ Stop the vehicle immediately in accordance with the traffic conditions.

- ▶ Activate the special seat belt retractor again and correctly secure the child restraint system.

When enabled, the special seat belt retractor ensures that the seat belts of the front passenger seat and rear seats do not slacken once the child restraint system is secured.

The seat belts on the following seats are equipped with a special seat belt retractor:

- Front passenger seat
- Rear seats

### Installing a child restraint system

- ▶ When installing a child restraint system, always observe the manufacturer's installation and operating instructions as well as the information in this Operator's Manual.
- ▶ Pull the seat belt smoothly from the seat belt outlet.
- ▶ Engage the seat belt tongue in the seat belt buckle.

**Activating the special seat belt retractor**

- ▶ Pull the seat belt out fully and let the inertia reel retract it again. When the special seat belt retractor is activated, you will hear a ratcheting sound.
- ▶ Push the child restraint system down until the seat belt sits tightly.

**Deactivating the special seat belt retractor**

- ▶ Press the release button of the seat belt buckle.
- ▶ Hold the seat belt tongue and guide back to the seat belt outlet.

**Installing a LATCH-type (ISOFIX) child restraint system on the left and right rear seats****Installing a LATCH-type (ISOFIX) child restraint system on the left and right rear seats**

**⚠ WARNING** Risk of accident if the rear bench seat, rear seat and seat backrest are not engaged

The rear bench seat, rear seat and seat backrest may fold forwards, even when you are driving.

- As a result, the vehicle occupant will be pushed into the seat belt with increased force. The seat belt will not be able to protect as intended and could cause additional injury.
- Objects or loads in the trunk or cargo compartment will not be restrained by the seat backrest.
- ▶ Make sure that the rear bench seat, the rear seat and the seat backrest are engaged before every trip.

If the left and right seat backrests are not engaged and locked in place, this will be shown on the display on the instrument cluster.

If the center seat backrest is not engaged and locked in place, the red lock verification indicator will be visible.

**⚠ WARNING** Risk of injury or death if the permissible gross mass of the child and child restraint system together is exceeded.

Too much load may be placed on the LATCH-type (ISOFIX) child restraint system and the child may not be restrained correctly in the event of an accident, for example.

- ▶ If the child and the child restraint system together weigh more than the permissible gross mass of 73 lb (33 kg ), only use a LATCH-type (ISOFIX) child restraint system with which the child is secured with the vehicle seat belt.
- ▶ Also secure the child restraint system with the Top Tether belt, if available.



Always comply with the information about the mass of the child restraint system:

- In the manufacturer's installation and operating instructions for the child restraint system used
- On a label on the child restraint system, if present

Regularly check that the permissible gross mass of the child and child restraint system is still complied with.

When installing a child restraint system, observe the following:

- ✓ Always observe the correct use of the seats and consider their suitability for attaching a child restraint system.
- ✓ Always comply with the manufacturer's installation and operating instructions for the child restraint system used.
- ✓ Make sure that the child's feet do not touch the front seat. If necessary, move the front seat slightly forwards.

 When installing a LATCH-type (ISOFIX) child restraint system, also observe the following:

- ✓ **When using a baby car seat in weight group 0/0+ and a rearward-facing child restraint system in weight group I on a rear seat:** adjust the front seat so that the seat does not touch the child restraint system.
- ✓ **When using a forward-facing child restraint system in weight group I:** the backrest of the child restraint system must lie as flat as possible against the backrest of the vehicle seat.
- ✓ If the head restraint of the child seat cannot be fully extended when it is installed in the vehicle, this will result in restrictions on the maximum size setting for child restraint systems in weight group II or III.  
Contact with the roof when the head restraint is fully extended and locked in place will not result in any restrictions on use.
- ✓ The child restraint system must not be put under strain between the roof and the seat cushion and/or be installed facing the wrong direction. Where possible, adjust the seat cushion inclination accordingly.

- ✓ The child restraint system must not be put under strain by the head restraint. Adjust the head restraints as appropriate.

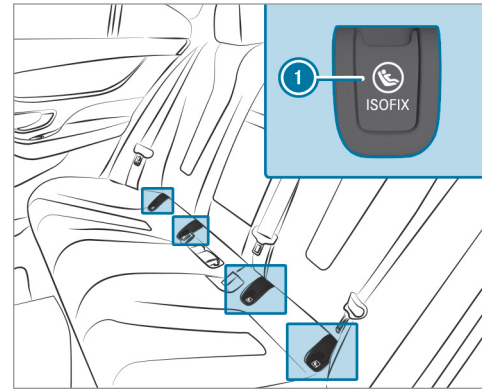

**1** LATCH-type (ISOFIX) mounting bracket

Before every journey, make sure that the LATCH-type (ISOFIX) child restraint system is engaged correctly in both mounting brackets in the vehicle.

**NOTE** Damage to the seat belt for the center seat during installation of the child restraint system

- ▶ Make sure that the seat belt is not trapped.

- ▶ Remove and stow away covers ①.
- ▶ Attach the LATCH-type (ISOFIX) child restraint system to both mounting brackets in the vehicle.
- ▶ After removing the child seat, reattach covers ①.

### Fastening a Top Tether

**WARNING** Risk of injury or death if the rear seat backrests are not locked after Top Tether belts are installed

The rear seat backrests may fold forwards when you are driving.

As a result, child restraint systems will no longer be able to perform their intended protec-

tive function. This may also cause additional injuries.

- ▶ Always lock rear seat backrests after installing Top Tether belts.
- ▶ Observe the lock verification indicator.

If the left and right seat backrests are not engaged and locked in place, this will be shown on the display on the instrument cluster.

If the center seat backrest is not engaged and locked in place, the red lock verification indicator will be visible.



If the child restraint system is equipped with a Top Tether belt:

The risk of injury may be reduced by Top Tether. The Top Tether belt enables an additional connection between the child restraint system attached with LATCH-type (ISOFIX) (left and right rear seats) or the seat belt (all rear seats) and the vehicle.

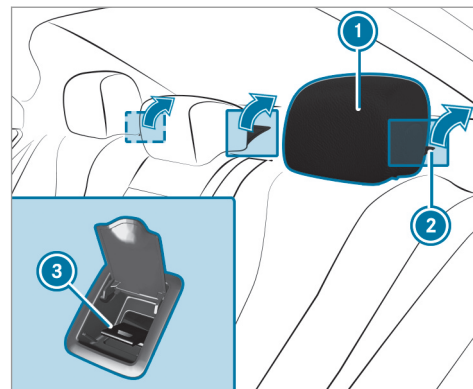

- ▶ If necessary, slide head restraint ① upwards (→ page 88).
- ▶ Fold up cover ② of Top Tether anchorage ③.
- ▶ Install the LATCH-type (ISOFIX) or belt-secured child restraint system with Top Tether. In doing so, comply with the child restraint system manufacturer's installation instructions.

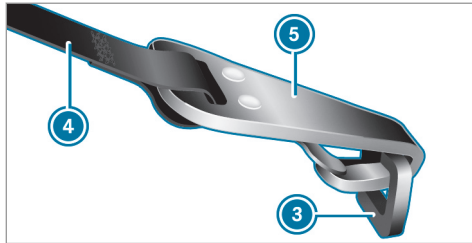

- ▶ Guide Top Tether belt (4) under head restraint (1) between the two head restraint bars.
- ▶ Hook Top Tether hook (5) of Top Tether belt (4) into Top Tether anchorage (3) without twisting.
- ▶ Tension Top Tether belt (4). In doing so, comply with the child restraint system manufacturer's installation instructions.
- ▶ Fold down cover (2) of Top Tether anchorage (3).
- ▶ If necessary, slide head restraint (1) downwards (→ page 88). Make sure that you do not interfere with the correct routing of Top Tether belt (4).

### Securing the child restraint system with the seat belt

#### Securing the child restraint system with the seat belt on the rear seat

**⚠ WARNING** Risk of accident if the rear bench seat, rear seat and seat backrest are not engaged

The rear bench seat, rear seat and seat backrest may fold forwards, even when you are driving.

- As a result, the vehicle occupant will be pushed into the seat belt with increased force. The seat belt will not be able to protect as intended and could cause additional injury.
  - Objects or loads in the trunk or cargo compartment will not be restrained by the seat backrest.
- ▶ Make sure that the rear bench seat, the rear seat and the seat backrest are engaged before every trip.

If the left and right seat backrests are not engaged and locked in place, this will be shown on the display on the instrument cluster.

If the center seat backrest is not engaged and locked in place, the red lock verification indicator will be visible.

#### When installing a belt-secured child restraint system, observe the following:

- ☑ Always comply with the manufacturer's installation and operating instructions for the child restraint system used.
- ☑ Also secure Top Tether if present (→ page 54).
- ☑ **When using a weight category 0/0+ baby car seat and a weight category I rearward-facing child restraint system on a rear seat:** adjust the front seat so that the seat does not touch the child restraint system.
- ☑ The backrest of the forward-facing child restraint system must, as far as possible, be resting on the seat backrest of the rear seat.
- ☑ If the head restraint of the child seat cannot be fully extended when it is installed in the

vehicle, this will result in restrictions on the maximum size setting for child restraint systems in weight category II or III.

Contact with the roof when the head restraint is fully extended and locked in place will not result in any restrictions on use.

- ☑ The child restraint system must not be put under strain between the roof and the seat cushion and/or be installed facing the wrong direction. Where possible, adjust the seat cushion inclination accordingly.
- ☑ The child restraint system must not be put under strain by the head restraint. Adjust the head restraints as appropriate.
- ☑ Make sure that the child's feet do not touch the front seat. If necessary, move the front seat slightly forwards.

The seat belts on the following seats are equipped with a special seatbelt retractor:

- Front passenger seat
- Rear seats

When enabled, the special seatbelt retractor ensures that the seat belts of the front passenger

seat and rear seats do not slacken once the child restraint system is secured (→ page 51).

- ▶ Install the child restraint system. The entire base of the child restraint system must always rest on the seat surface of the rear seat.
- ▶ Always make sure that the shoulder belt strap is correctly routed from the seat belt outlet of the vehicle to the shoulder belt guide on the child restraint system. The shoulder belt strap must be routed forward from the seat belt outlet.

#### Notes on rearward-facing and forward-facing child restraint systems on the front passenger seat

**⚠ WARNING** Risk of injury or fatal injury when using a rearward-facing child restraint system while the co-driver airbag is enabled

If you secure a child in a rearward-facing child restraint system on the co-driver seat and the PASSENGER AIR BAG OFF indicator lamp is off, the co-driver airbag can deploy in the event of an accident.

The child could be struck by the airbag.

- ▶ Always ensure that the co-driver airbag is disabled. The PASSENGER AIR BAG OFF indicator lamp must be lit.
- ▶ NEVER use a rearward-facing child restraint system on a seat with an ENABLED FRONT AIRBAG; DEATH or SERIOUS INJURY to the CHILD can occur.

Observe the specific instructions for the rearward-facing and forward-facing child restraint systems (→ page 57).

Always observe the status of the front passenger airbag on the PASSENGER AIR BAG OFF indicator lamp:

- When using a rearward-facing child restraint system on the front passenger seat, the front passenger airbag must always be disabled. This is only the case if the PASSENGER AIR BAG OFF indicator lamp is lit continuously (→ page 43).
- If the PASSENGER AIR BAG OFF indicator lamp is off, the front passenger airbag is ena-

bled. The front passenger airbag may deploy during an accident.

### Securing the child restraint system with the seat belt on the front passenger seat

When installing a belt-secured child restraint system on the front passenger seat, always observe the following:

- ✔ Observe the notes on rearward-facing and forward-facing child restraint systems on the front passenger seat (→ page 56).
- ✔ Observe the child restraint system manufacturer's installation and operating instructions.
- ✔ When using a forward-facing child restraint system in weight category I: remove the head restraint from the respective seat, if possible. After the child restraint system has been removed, replace the head restraint immediately and adjust all head restraints correctly.
- ✔ The backrest of the forward-facing child restraint system must, as far as possible, be resting on the seat backrest of the front passenger seat.

- ✔ If the head restraint of the child seat cannot be fully extended when it is installed in the vehicle, this will result in restrictions on the maximum size setting for child restraint systems in weight category II or III. Contact with the roof when the head restraint is fully extended and locked in place will not result in any restrictions on use.
- ✔ The child restraint system must not be put under strain between the roof and the seat cushion and/or be installed facing the wrong direction.
- ✔ The child restraint system must not be put under strain by the head restraint. Adjust the head restraints as appropriate.
- ✔ Never place objects (e.g. cushions) under or behind the child restraint system.

The seat belt on the front passenger side is equipped with a special seatbelt retractor.

When enabled, the special seatbelt retractor ensures that the seat belt does not slacken once the child seat is secured (→ page 51).

**⚠ WARNING** Risk of injury or death due to objects between the seat surface and the child restraint system

Objects between the seat surface and the child restraint system could affect the function of the automatic front passenger airbag shut-off.

- ▶ Do not place any objects between the seat surface and the child restraint system.
- ▶ Always make sure that the child restraint system is correctly installed.

- ▶ Set the front passenger seat as far back as possible and move the seat into the highest position if possible.
- ▶ Fully retract the seat cushion length adjustment.
- ▶ Adjust the seat cushion inclination so that the front edge of the seat cushion is in the highest position and the rear edge of the seat cushion is in the lowest position.

- ▶ Set the seat backrest to the most vertical position possible.
- ▶ Install the child restraint system. The entire base of the child restraint system must always rest on the sitting surface of the front passenger seat.
- ▶ Always make sure that the shoulder belt strap is correctly routed from the seat belt outlet of the vehicle to the shoulder belt guide on the child restraint system. The shoulder belt strap must be routed forwards and downwards from the seat belt outlet.
- ▶ If necessary, adjust the seat belt outlet and the front passenger seat accordingly.

### Child safety locks

#### Activating or deactivating the child safety lock for the rear doors

**⚠ WARNING** Risk of accident and injury due to children left unattended in the vehicle

If children are left unsupervised in the vehicle, they could, in particular:

- open doors, thereby endangering other persons or road users.
- get out and be struck by oncoming traffic.
- operate vehicle equipment and become trapped, for example.

In addition, the children could also set the vehicle in motion, for example by:

- releasing the parking brake.
- changing the transmission position.
- starting the vehicle.

- ▶ Never leave children unattended in the vehicle.

- ▶ When leaving the vehicle, always take the SmartKey with you and lock the vehicle.
- ▶ Keep the vehicle SmartKey out of reach of children.

**⚠ WARNING** Danger to life due to exposure to extreme heat or cold in the vehicle

If people, particularly children, are exposed to extreme temperatures over an extended period of time, there is a risk of serious injury or danger to life.

- ▶ Never leave persons, children in particular, unattended in the vehicle.

**⚠ WARNING** Risk of accident and injury due to children left unattended in the vehicle

If children are traveling in the vehicle, they could, in particular:

- Open doors, thereby endangering other persons or road users.
- Get out and be struck by oncoming traffic.

- Operate vehicle equipment and become trapped, for example.
- ▶ Always activate the installed child safety locks if children are traveling in the vehicle.
- ▶ Never leave children unattended in the vehicle.
- ▶ When leaving the vehicle, always take the SmartKey with you and lock the vehicle.

There are child safety locks for the rear doors and the rear side windows. The child safety lock on the rear doors secures each door separately. The doors can no longer be opened from the inside.

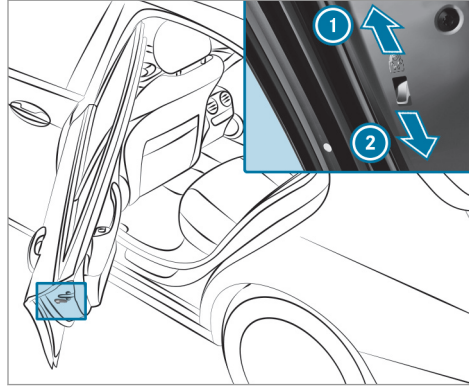

- ▶ Press the lever in direction ① (activate) or ② (deactivate).
- ▶ Make sure that the child safety locks are working properly.

### Activating and deactivating the child safety lock for the rear side windows

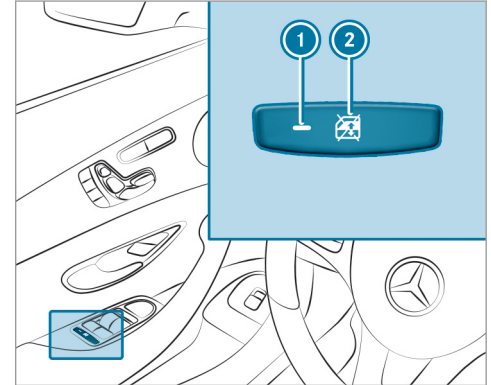

- ▶ **To activate/deactivate:** press button ②.
- The rear side window can be opened or closed in the following cases:
- Indicator lamp ① is lit: via the switch on the driver's door

- Indicator lamp ① is off: via the switch on the corresponding rear door or driver's door

### Notes on pets in the vehicle

**⚠ WARNING** Risk of accident and injury due to animals left unsecured or unattended in the vehicle

If you leave animals in the vehicle unattended or unsecured, they could possibly press buttons or switches.

An animal may:

- Activate vehicle equipment and become trapped, for example
- Switch systems on or off and endanger other road users

Unsecured animals may be thrown around in the vehicle in the event of an accident or sudden steering and braking maneuvers and injure vehicle occupants in the process.

- ▶ Never leave animals in the vehicle unattended.
- ▶ Always correctly secure animals while driving, e.g. using a suitable animal carrier.



## SmartKey

### Overview of SmartKey functions

**⚠ WARNING** Risk of accident and injury due to children left unattended in the vehicle

If children are left unsupervised in the vehicle, they could, in particular:

- open doors, thereby endangering other persons or road users.
- get out and be struck by oncoming traffic.
- operate vehicle equipment and become trapped, for example.

In addition, the children could also set the vehicle in motion, for example by:

- releasing the parking brake.
- changing the transmission position.
- starting the vehicle.

▶ Never leave children unattended in the vehicle.

- ▶ When leaving the vehicle, always take the SmartKey with you and lock the vehicle.
- ▶ Keep the vehicle SmartKey out of reach of children.

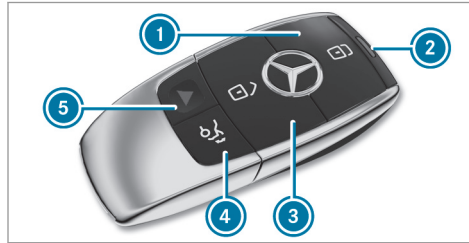

**⚠ NOTE** Damage to the SmartKey caused by magnetic fields

- ▶ Keep the SmartKey away from strong magnetic fields.



Vehicle SmartKey with panic alarm

- ① Locks
- ② Indicator lamp

- ③ Unlocks
  - ④ Opens/closes the trunk lid
  - ⑤ Panic alarm
- ① If indicator lamp ② does not light up after pressing the  or  button, the battery is weak or possibly discharged. Replace the battery as soon as possible.

Replace the SmartKey battery (→ page 63).

The SmartKey locks and unlocks the following components:

- Doors
- Fuel filler flap
- Trunk lid

If the vehicle is not opened within approximately 40 seconds after unlocking, it locks again. Anti-theft protection is activated again.

Do not keep the SmartKey together with electronic devices or metal objects. This can affect the SmartKey's functionality.

### Activating/deactivating the acoustic locking verification signal

Multimedia system:

→  → Settings → Vehicle

- ▶ Activate or deactivate **Acoustic Lock**.

### Arming/disarming the panic alarm

#### Requirements:

- The vehicle is switched off.



- ▶ **To activate:** press button ① for approximately one second.  
A visual and audible alarm is triggered.



- ▶ **To deactivate:** briefly press button ① again.  
or

- ▶ Press the start/stop button.  
A SmartKey belonging to the vehicle must be detected in the vehicle.

### Changing the unlocking settings

Possible unlocking functions of the SmartKey:

- Central unlocking
- Unlocking the driver's door and fuel filler flap

- ▶ **To switch between settings:** press the  and  buttons simultaneously for approximately six seconds until the indicator lamp flashes twice.

Options if the unlocking function for the driver's door and fuel filler flap has been selected:

- **To unlock the vehicle centrally:** press the  button twice.
- **Vehicles with KEYLESS-GO:** if you touch the inner surface of the door handle on the driver's door, only the driver's door and the fuel filler flap are unlocked.

### Deactivating the function of the SmartKey

**Vehicles with KEYLESS-GO:** if you deactivate the function of the SmartKey, the KEYLESS-GO functions are also deactivated. Access or drive authorization by KEYLESS-GO is then no longer possible with that particular SmartKey. Activate the function of the SmartKey so that all its functions will again be available.

You can also deactivate the function of the SmartKey to reduce the energy consumption of the SmartKey if you do not use the vehicle or a SmartKey for an extended period of time.

- ▶ **To deactivate:** press the  button on the SmartKey twice in quick succession.  
The SmartKey indicator lamp flashes twice briefly and lights up once.
- ▶ **To activate:** press any button on the SmartKey.  
  - ① When the vehicle is started with the SmartKey in the marked space of the center console, the function of the SmartKey is automatically activated (→ page 136).

## Removing/inserting the emergency key

### Removing the emergency key

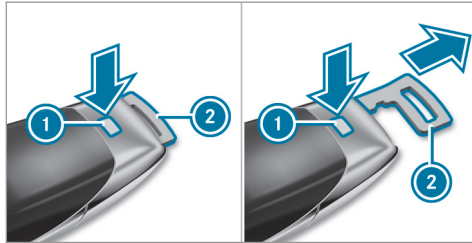

- ▶ Press release button ①. Emergency key ② is pushed out slightly.
- ▶ Pull out emergency key ② until it engages in the intermediate position.
- ▶ Press release button ① again and fully remove emergency key ②.

### Inserting the emergency key

- ▶ Press release button ①.
- ▶ Insert emergency key ② to the intermediate position or fully until it engages.

- ① You can use the intermediate position of emergency key ② to attach the SmartKey to a key ring.

## Replacing the SmartKey battery

**⚠ DANGER** Risk of fatal injuries due to swallowing batteries

Batteries contain toxic and corrosive substances. Swallowing batteries may cause severe internal burns to occur within two hours.

There is a risk of fatal injury.

- ▶ Keep batteries out of the reach of children.
- ▶ If the cap and/or the battery compartment does not close securely, do not use the SmartKey any longer and keep out of the reach of children.
- ▶ If batteries are swallowed, seek medical attention immediately.

**🔥 ENVIRONMENTAL NOTE** Environmental damage due to improper disposal of batteries



Batteries contain pollutants. It is illegal to dispose of them with the household rubbish.



Dispose of batteries in an environmentally responsible manner. Take discharged batteries to a qualified specialist workshop or to a collection point for used batteries.

### Requirements:

- You require a CR 2032 3 V cell battery.

Mercedes-Benz recommends that you have the battery replaced at a qualified specialist workshop.

- ▶ Remove the emergency key (→ page 63).

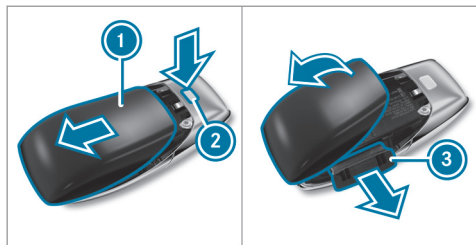

- ▶ Press release knob (2) down fully and slide cover (1) in the direction of the arrow.
- ▶ Fold out cover (1) in the direction of the arrow and remove.
- ▶ Remove battery compartment (3) and take out the discharged battery.
- ▶ Insert the new battery into battery compartment (3). Observe the positive pole marking in the battery compartment and on the battery when doing this.
- ▶ Push in battery compartment (3).
- ▶ Re-attach cover (1) and push it until it engages.

### Problems with the SmartKey, troubleshooting

#### You can no longer lock or unlock the vehicle

Possible causes:

- The SmartKey battery is weak or discharged.
- ▶ Check the battery using the indicator lamp (→ page 61).
- ▶ Replace the SmartKey battery, if necessary (→ page 63).
- ▶ Use the replacement SmartKey.
- ▶ Use the emergency key to lock or unlock (→ page 68).
- ▶ Have the SmartKey checked at a qualified specialist workshop.

#### There is interference from a powerful radio signal source

Possible causes if the function of the SmartKey is impaired:

- High voltage power lines
- Mobile phones
- Electronic devices (notebooks, tablets)

- Shielding due to metal objects or induction loops for electrical gate systems or automatic barriers

- ▶ Make sure that there is sufficient distance between the SmartKey and the potential source of interference.

#### You have lost a SmartKey

- ▶ Have the SmartKey deactivated at a qualified specialist workshop.
- ▶ If necessary, have the mechanical lock replaced as well.

## Doors

## Unlocking/opening the doors from the inside

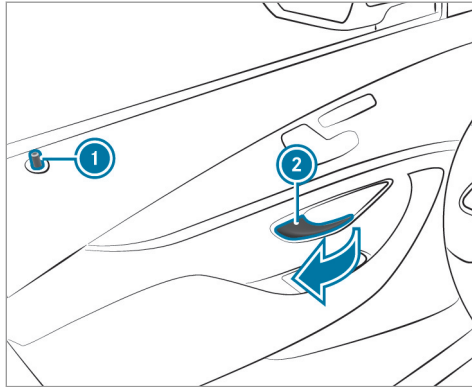

- ▶ **To unlock and open a front door:** pull door handle ②. Locking pin ① pops up when the door is unlocked.

- ▶ **To unlock a rear door:** pull the rear door handle. The locking pin pops up when the rear door is unlocked.
- ▶ **To open a rear door:** pull the rear door handle again.

## Centrally locking and unlocking the vehicle from the inside

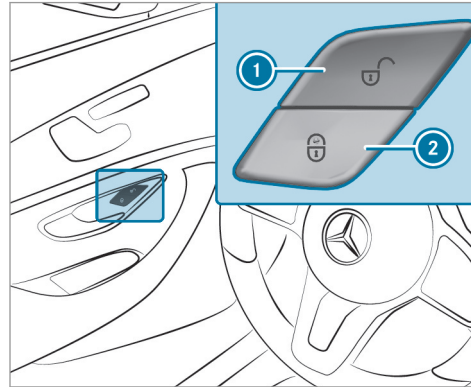

- ▶ **To unlock:** press button ①.
- ▶ **To lock:** press button ②.

ⓘ The buttons are also on the front passenger door.

This does not lock or unlock the fuel filler flap.

The vehicle is not unlocked:

- If you have locked the vehicle using the SmartKey
- If you have locked the vehicle using KEYLESS-GO

## Locking/unlocking the vehicle with KEYLESS-GO

## Requirements:

- The SmartKey is outside the vehicle.
- The distance between the SmartKey and the vehicle does not exceed 3 ft (1 m).
- The driver's door and the door on which the door handle is used are closed.

**NOTE** Damage to the vehicle caused by unintentionally opening the trunk lid

- When using an automatic car wash
  - When using a high pressure cleaner
- ▶ Deactivate the function of the SmartKey in these situations.
- or
- ▶ Make sure that the SmartKey is at a minimum distance of 10 ft (3 m) away from the vehicle.

Observe the notes:

- On washing the vehicle in a car wash (→ page 274)
- On using a high pressure cleaner (→ page 275)

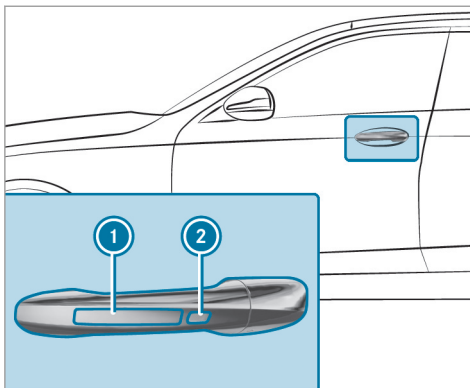

- ▶ **To unlock the vehicle:** touch the inner surface of the door handle.
- ▶ **To lock the vehicle:** touch sensor surface ① or ②.
- ▶ **Convenience closing:** touch recessed sensor surface ② until the closing process has been completed.

① Further information on convenience closing (→ page 76).

If you open the trunk lid from outside, it is automatically unlocked.

### Problems with KEYLESS-GO, troubleshooting

#### **You can no longer lock or unlock the vehicle using KEYLESS-GO**

Possible causes:

- The function of the SmartKey has been deactivated.
  - The SmartKey battery is weak or discharged.
- ▶ Activate the function of the SmartKey (→ page 62).
- ▶ Check the battery using the indicator lamp (→ page 61).
- ▶ Replace the SmartKey battery, if necessary (→ page 63).
- ▶ Use the replacement SmartKey.
- ▶ Use the emergency key to lock or unlock (→ page 68).

- ▶ Have the vehicle and SmartKey checked at a qualified specialist workshop.

### There is interference from a powerful radio signal source

Possible causes if the function of KEYLESS-GO is impaired:

- High voltage power lines
  - Mobile phones
  - Electronic devices (notebooks, tablets)
  - Shielding due to metal objects or induction loops for electrical gate systems or automatic barriers
- ▶ Make sure that there is sufficient distance between the SmartKey and the potential source of interference.

### Activating/deactivating the automatic locking feature

The vehicle is locked automatically when the vehicle is switched on and the wheels are turning faster than walking pace.

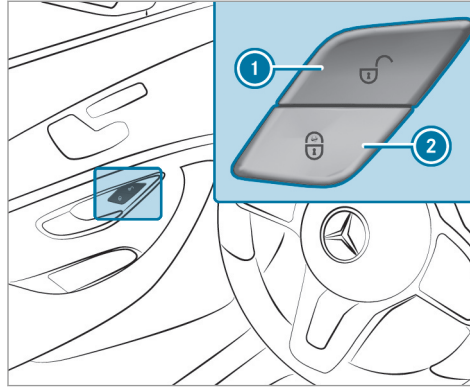

- ▶ **To activate:** press and hold button ② for approximately five seconds until an acoustic signal sounds.
- ▶ **To deactivate:** press and hold button ① for approximately five seconds until an acoustic signal sounds.

In the following situations, there is a danger of being locked out when the function is activated:

- While the vehicle is being tow-started or pushed
- If the vehicle is being tested on a roller dynamometer

### Power closing function

**⚠ WARNING** Risk of becoming trapped when the doors close automatically

Body parts or objects can become trapped, causing injuries.

- ▶ Ensure that no body parts or objects are in the closing area.
- ▶ Automatic closing of the doors can be canceled by pulling the outer or inner door handle.

If you push the door into the lock to the first detent position, the power closing function will automatically pull the door into the lock.

### Locking/unlocking the driver's door with the emergency key

- ❗ If you wish to lock the vehicle entirely using the emergency key, first press the button for locking from the inside while the driver's door is open. Then proceed to lock the driver's door using the emergency key.

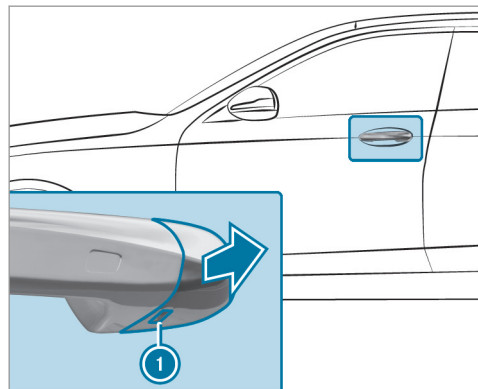

- ▶ Remove the emergency key (→ page 63).

- ▶ Insert the emergency key as far as it will go into opening ❶ in the cover.
- ▶ Pull and hold the door handle.
- ▶ Pull the cover on the emergency key as straight as possible away from the vehicle until it releases.
- ▶ Release the door handle.

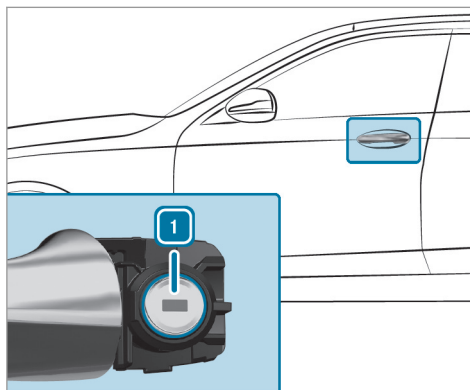

- ▶ **To unlock:** turn the emergency key counter-clockwise to position ❶.
- ▶ **To lock:** turn the emergency key clockwise to position ❶.
- ▶ Carefully press the cover onto the lock cylinder until it engages and is seated firmly.

### Trunk

#### Opening the trunk lid

#### ⚠ DANGER Risk of exhaust gas poisoning

Combustion engines emit poisonous exhaust gases such as carbon monoxide. Exhaust gases can enter the vehicle interior if the trunk lid is open when the vehicle is running, especially if the vehicle is in motion.

- ▶ Always switch off the vehicle before opening the trunk lid.
- ▶ Never drive with the trunk lid open.



**!** **NOTE** Damage to the trunk lid by obstacles above the vehicle

The trunk lid swings upwards when it is opened.

- ▶ Therefore, make sure that there is sufficient clearance above the trunk lid.

▶ With the trunk lid unlocked, press the top of the Mercedes star.

**i** To open, pull on the folded-out Mercedes star when the rear view camera is activated.

▶ **Vehicles with HANDS-FREE ACCESS:** Make a kicking movement with your foot below the bumper (→ page 72).

### Vehicles with trunk lid convenience closing

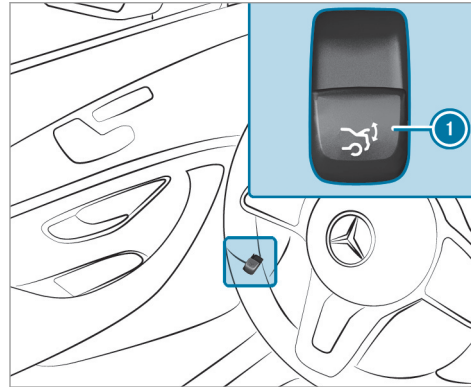

▶ Pull remote operating switch **1** until the trunk lid opens.

or

▶ Press and hold the  button on the Smart-Key.

▶ If the trunk lid is stopped in an intermediate position, pull it upwards. Release it as soon as it begins to open.

▶ With the trunk lid opening height restriction activated, manually pull the stopped trunk lid upwards.

If an obstacle obstructs the trunk lid during the automatic opening process, blockage detection will stop the trunk lid. The automatic blockage detection function is only an aid and is not a substitute for your attentiveness.

### Closing the trunk lid

**!** **WARNING** Risk of injury from unsecured items in the vehicle

If objects, luggage or loads are not secured or not secured sufficiently, they could slip, tip over or be thrown around and thereby hit vehicle occupants.

There is a risk of injury, particularly in the event of sudden braking or a sudden change in direction.

- ▶ Always stow objects in such a way that they cannot be thrown around.
- ▶ Before the journey, secure objects, luggage or loads against slipping or tipping over.

Observe the notes on loading the vehicle.

**Notes on closing the trunk lid:** your vehicle is equipped with automatic SmartKey recognition. If a SmartKey belonging to the vehicle is detected in the vehicle, the trunk lid will not be locked and will pop open again.

Note that the trunk lid will not be locked if the following situation occurs:

- You have locked the vehicle and close the trunk lid while a SmartKey belonging to the vehicle is inside the vehicle.  
and
- A second SmartKey belonging to the vehicle is not detected outside the vehicle.

Automatic SmartKey recognition is only an aid and is not a substitute for your attentiveness.

- ▶ Before locking, ensure that at least one SmartKey belonging to the vehicle is outside the vehicle.
- ▶ **To close the trunk lid:** pull the trunk lid downwards using the handle recess and push it closed.

#### Vehicles with trunk lid convenience closing

**⚠ WARNING** Risk of becoming trapped during automatic closing of the trunk lid

Parts of the body could become trapped. There may be people in the closing area.

- ▶ Make sure that nothing is located within the vicinity of the closing area.
- ▶ Use one of the following options to stop the closing process:
  - Press the  button on the SmartKey.
  - Press or pull the remote operating switch on the driver's door.
  - Press the closing or locking button on the trunk lid.

- Press the top of the star on the trunk lid.

**Vehicles with HANDS-FREE ACCESS:** it is also possible to stop the closing process by making a kicking movement below the rear bumper.

- ▶ **To close the trunk lid:** pull the trunk lid downwards using the handle recess and push it closed.
- ▶ If the trunk lid is stopped in an intermediate position, push it downwards. The trunk lid will continue to close.

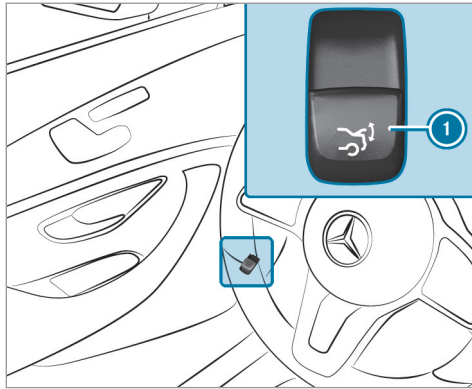

- ▶ Push remote operating switch ① until the trunk lid is fully closed.

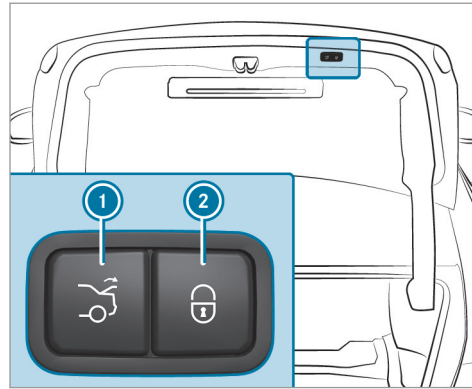

- ▶ Press closing button ① on the trunk lid.

#### Vehicles with KEYLESS-GO

- ▶ Press locking button ② on the trunk lid. If a SmartKey is detected outside the vehicle, the trunk lid will close and the vehicle will be locked.
- ▶ With the trunk lid completely open, press and hold the  button on the SmartKey. The

SmartKey must be in the vicinity of the vehicle.

#### Vehicles with HANDS-FREE ACCESS

- ▶ With the trunk lid completely open, make a kicking movement with your foot below the bumper (→ page 72).

#### Trunk lid automatic reversing function

The trunk lid is equipped with automatic blockage detection with a reversing function. If an obstacle obstructs the trunk lid during the automatic closing process, it will automatically open again. The automatic reversing function is only an aid and is not a substitute for your attentiveness.

- ▶ During the closing process, make sure that no body parts are in the closing area.

**⚠ WARNING** Risk of becoming trapped despite reversing function

The reversing function will not react:

- to soft, light and thin objects, e.g. fingers
- towards the end of the closing procedure

In these situations in particular, the reversing function cannot prevent someone being trapped.

- ▶ Ensure that no body parts are in the closing area.
- ▶ If someone is trapped, use one of the following options:
  - Press the  button on the SmartKey.
  - Press the remote operating switch on the driver's door.
  - Press the closing or locking button on the trunk lid.
  - Press the top of the Mercedes star on the trunk lid.

### HANDS-FREE ACCESS function

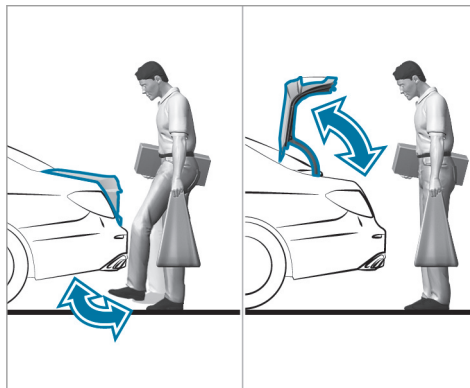

With HANDS-FREE ACCESS you can open, close or interrupt trunk lid movement by performing a kicking movement under the rear bumper.

The kicking movement triggers the opening or closing process alternately.

Observe the notes when opening (→ page 68) and closing (→ page 69) the trunk lid.

- ⓘ A warning tone sounds while the trunk lid is opening or closing.

**⚠ WARNING** Risk of burns caused by a hot exhaust system

The vehicle exhaust system can become very hot. If you use HANDS-FREE ACCESS, you could burn yourself by touching the exhaust system.

- ▶ Always ensure that you only make a kicking movement within the detection range of the sensors.

**! NOTE** Damage to the vehicle caused by unintentionally opening the trunk lid

- When using an automatic car wash
- When using a high pressure cleaner
- ▶ Deactivate the function of the SmartKey in these situations.

or

- ▶ Make sure that the SmartKey is at a minimum distance of 10 ft (3 m) away from the vehicle.

When making the kicking movement, make sure that you are standing firmly on the ground. You could otherwise lose your balance, e.g. on ice.

Observe the following notes:

- The SmartKey is behind the vehicle.
- Stand at least 12 in (30 cm) away from the vehicle while performing the kicking movement.
- Do not come into contact with the bumper while making the kicking movement.
- Do not carry out the kicking movement too slowly.
- The kicking movement must be towards the vehicle and back again.

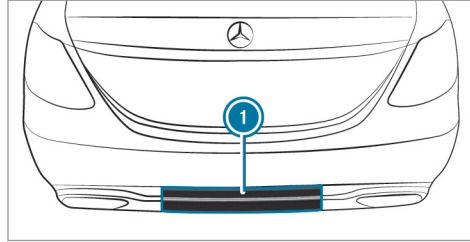

#### ① Detection range of the sensors

If several consecutive kicking movements are not successful, wait ten seconds.

#### System limits

The system may be impaired or may not function in the following cases:

- The sensors are dirty, e.g. due to road salt or snow.
- The kicking movement is made using a prosthetic leg.

The trunk lid could be opened or closed unintentionally, in the following situations:

- A person's arms or legs are moving in the sensor detection range, e.g. when polishing the vehicle or picking up objects.
- Objects are moved or placed behind the vehicle, e.g. the hose of a fuel dispenser, a charging cable, or luggage
- Clamping straps, tarps or other coverings are pulled over the bumper.
- A protective mat with a length reaching over the trunk sill down into the detection range of the sensors is used.
- The protective mat is not secured correctly.

Deactivate the function of the SmartKey (→ page 62) or do not carry the SmartKey about your person in such situations.

#### Switching separate trunk locking on or off

If you centrally unlock the vehicle while separate locking is activated, the trunk will remain locked.

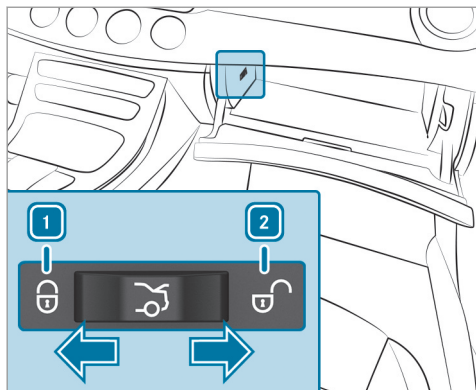

▶ **To switch on:** slide the switch to position **1**.

▶ **To switch off:** slide the switch to position **2**.

ⓘ If an accident has been detected, the trunk will unlock even if separate locking is switched on.

### Unlocking and opening the trunk from inside with the emergency release

#### Requirements:

- The 12 V vehicle battery is connected and charged.

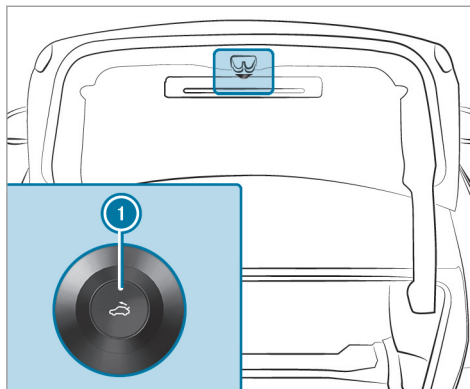

▶ Press emergency release button **1** briefly.

### Side windows

#### Opening and closing the side windows

**⚠ WARNING** Risk of entrapment when opening a side window

When opening a side window, parts of the body could be drawn in or become trapped between the side window and window frame.

- ▶ When opening, make sure that nobody is touching the side window.
- ▶ If someone is trapped, release the button immediately or pull it in order to close the side window again.

**⚠ WARNING** Risk of becoming trapped when closing a side window

When closing a side window, body parts could be trapped in the closing area in the process.

- ▶ When closing, make sure that no body parts are in the closing area.

- ▶ If someone is trapped, release the button immediately or press the button in order to reopen the side window.

**⚠ WARNING** Risk of becoming trapped when children operate the side windows

Children could become trapped if they operate the side windows, particularly when unattended.

- ▶ Activate the child safety lock for the rear passenger compartment side windows.
- ▶ When leaving the vehicle, always take the SmartKey with you and lock the vehicle.
- ▶ Never leave children unattended in the vehicle.

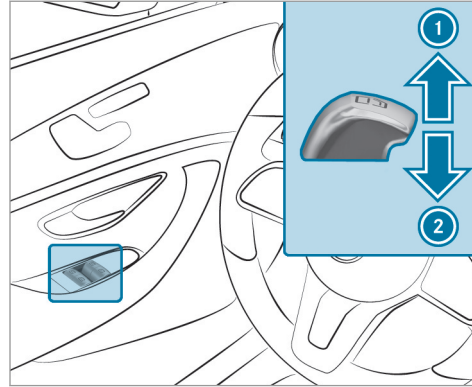

**Requirements:**

- The power supply or the vehicle has been switched on.



- ① Closes
- ② Opens

The buttons on the driver's door take precedence.

- ▶ **To start automatic operation:** press the  button beyond the point of resistance or pull and release it.
- ▶ **To interrupt automatic operation:** press or pull the  button again.

When the vehicle is switched off, you can continue to operate the side windows.

This function is available for around four minutes or until a front door is opened.

**Automatic reversing function of the side windows**

If an obstacle impedes a side window during the closing process, the side window will open again automatically. The automatic reversing function is only an aid and is not a substitute for your attentiveness.

- ▶ During the closing process, make sure that no body parts are in the closing area.

**⚠ WARNING** Risk of becoming trapped despite there being reversing protection on the side window

The reversing function does not react:

- To soft, light and thin objects, e.g. fingers.
- During resetting.

The reversing function cannot prevent someone from becoming trapped in these situations.

- ▶ During the closing process, make sure that no body parts are in the closing area.
- ▶ If someone becomes trapped, press the  button to open the side window again.

### Convenience opening (ventilating the vehicle before starting a journey)

**⚠ WARNING** Risk of entrapment when opening a side window

When opening a side window, parts of the body could be drawn in or become trapped between the side window and window frame.

- ▶ When opening, make sure that nobody is touching the side window.
- ▶ Release the button immediately if somebody becomes trapped.

#### Requirements:

- The SmartKey is in the immediate vicinity of the vehicle.

- ▶ Press and hold the  button on the SmartKey.

The following functions are performed:

- The vehicle is unlocked.
- The side windows are opened.
- The sliding sunroof is opened.
- The seat ventilation of the driver's seat is switched on.

- ▶ **To interrupt convenience opening:** release the  button.

- ▶ **To continue convenience opening:** press and hold the  button again.

### Convenience closing (closing the vehicle from outside)

**⚠ WARNING** Risk of entrapment due to not paying attention during convenience closing

When the convenience closing feature is operating, parts of the body could become trapped

in the closing area of the side window and the sliding sunroof.

- ▶ When the convenience closing feature is operating, monitor the entire closing process and make sure that no body parts are in the closing area.

#### Requirements:

- The SmartKey is in the immediate vicinity of the vehicle.

- ▶ Press and hold the  button on the SmartKey.

The following functions are performed:

- The vehicle is locked.
- The side windows are closed.
- The sliding sunroof is closed.

- ▶ **To interrupt convenience closing:** release the  button.

- ▶ **To continue convenience closing:** press and hold the  button again.

- ① Convenience closing also functions with KEY-LESS-GO (→ page 65).



### Resolving problems with the side windows

**⚠ WARNING** Risk of becoming trapped or fatally injured if reversing protection is not activated

If you close a side window again immediately after it has been blocked, the side window will close with increased or maximum force. The reversing function is then not active and body parts may become trapped.

- ▶ Make sure that no parts of the body are in the closing area.
- ▶ To stop the closing process, release the button or press the button again to reopen the side window.

**A side window cannot be closed and you cannot see the cause.**

- ▶ Check to see whether any objects are in the window guide.
- ▶ Adjust the side windows.

#### Adjusting the side windows

If a side window is obstructed during closing and reopens again immediately:

- ▶ Immediately after this, pull and hold the corresponding button again until the side window has closed and hold the button for at least one more second (re-adjustment). The side window will be closed without the automatic reversing function.

If the side window is obstructed again and reopens again immediately:

- ▶ Immediately after this, pull and hold the corresponding button again until the side window has closed and hold the button for at least one more second (follow-up adjustment). The side window will be closed without the automatic reversing function.

**The side windows cannot be opened or closed using the convenience opening feature.**

Possible causes:

- The SmartKey battery is weak or discharged.
- ▶ Check the battery using the indicator lamp (→ page 61).

- ▶ Replace the SmartKey battery, if necessary (→ page 63).

### Sliding sunroof

#### Opening and closing the sliding sunroof

**⚠ WARNING** Risk of becoming trapped when the sliding sunroof is being opened and closed

Body parts may become trapped in the range of movement.

- ▶ During opening and closing, make sure that no body parts are in the range of movement.
- ▶ Release the button immediately if somebody becomes trapped.

or

- ▶ Briefly press the button in any direction during automatic operation. The opening or closing process will be stopped.

**⚠ WARNING** Risk of becoming trapped if the sliding sunroof is operated by children

Children operating the sliding sunroof could get caught in the moving parts, particularly if unattended.

- ▶ Never leave children unattended in the vehicle.
- ▶ When leaving the vehicle, always take the key with you and lock the vehicle.

**! NOTE** Malfunction due to snow and ice

Snow and ice may cause the sliding sunroof to malfunction.

- ▶ Open the sliding sunroof only if it is free of snow and ice.

**! NOTE** Damage caused by protruding objects

Objects that protrude from the sliding sunroof may damage the seals.

- ▶ Do not allow anything to protrude from the sliding sunroof.

**! NOTE** Damage to the sliding sunroof when a roof luggage rack is installed

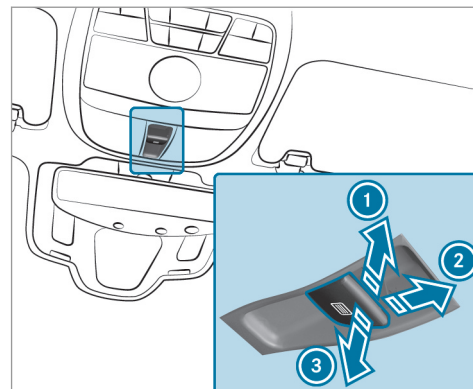

When a roof luggage rack is installed, raising or opening the sliding sunroof may be restricted.

- ▶ Check whether the sliding sunroof can be raised or opened when a roof luggage rack is installed.
- ▶ If in doubt, do not raise or open the sliding sunroof.



- ① To raise
- ② To open
- ③ To close/lower

- ▶ Check whether the sliding sunroof can be raised or opened when a roof luggage rack is installed.

- ▶ **To start automatic operation:** press the  button beyond the point of resistance or pull and release it.
- ▶ **To interrupt automatic operation:** briefly press the  button in any direction.  
The opening/closing process will be stopped.

**Vehicles without a panorama roof with power tilt/sliding panel:** The automatic opening and raising features are available only when the sliding sunroof is closed.

#### Automatic reversing function of the sliding sunroof

If an obstacle obstructs the sliding sunroof during the closing process, the sliding sunroof will open again automatically. The automatic reversing function is only an aid and is not a substitute for your attentiveness.

- ▶ During the closing process, make sure that no body parts are in the closing area.

**⚠ WARNING** Risk of becoming trapped despite the reversing function being active

In particular, the reversing function does not react:

- To soft, light and thin objects, e.g. fingers.
  - Towards the end of the closing procedure.
  - During resetting.
- ▶ During the closing process, make sure that no body parts are in the closing area.
  - ▶ Release the button immediately if somebody becomes trapped.
- or
- ▶ Briefly press the button in any direction during automatic operation.  
The closing process will be stopped.

#### Rectifying problems with the sliding sunroof

**⚠ WARNING** Risk of becoming trapped or fatal injuries when the sliding sunroof is closed again

If the sliding sunroof is closed again immediately after it has been blocked or reset, it will close with increased force.

- ▶ Make sure that no parts of the body are in the closing area.
  - ▶ Release the button immediately if somebody becomes trapped.
- or
- ▶ Briefly press the button in any direction during the automatic closing process.  
The closing process will be stopped.

**The sliding sunroof cannot be closed and you cannot see the cause.**

If the sliding sunroof is obstructed during closing and reopens again slightly:

- ▶ Immediately after automatic reversing, pull and hold the  button down again to the

point of resistance until the sliding sunroof is closed.

The sliding sunroof will be closed with increased force.



If the sliding sunroof is obstructed again and opens again slightly:

- ▶ Repeat the previous step.  
The sliding sunroof will be closed again with increased force.

**Vehicles without a panorama roof with power tilt/sliding panel: The sliding sunroof is not operating smoothly.**

- ▶ Reset the sliding sunroof.

#### Resetting the sliding sunroof

- ▶ Push the  button up to the point of resistance repeatedly until the sliding sunroof is fully open.
- ▶ Press the  button for another second.
- ▶ Close the sliding sunroof.

#### Roller sun blinds

##### Extending or retracting the rear-window roller sunblind

**⚠ WARNING** Risk of becoming trapped when extending or retracting the roller sunblind

Body parts may become trapped in the roller sunblind's range of movement.

- ▶ Ensure there are no body parts in the range of movement.
- ▶ If someone becomes trapped, briefly press the button again.  
The opening or closing process will briefly be stopped. The roller sunblind will then return to its starting position.

**! NOTE** Damage caused by objects

Objects can cause the roller sunblind to malfunction.

- ▶ Do not store objects on the rear shelf.
- ▶ Ensure that the roller sunblind can move freely.

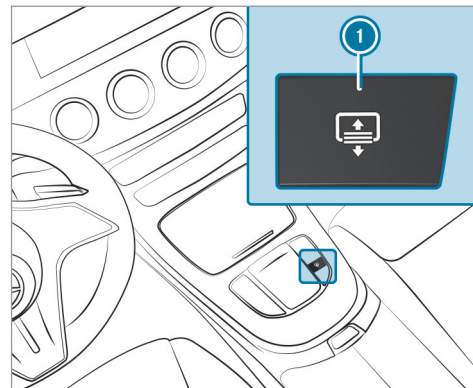

- ▶ **To extend or retract:** press button ①.

#### Anti-theft protection

##### Function of the immobilizer

The immobilizer prevents your vehicle from being started without the correct SmartKey.

The immobilizer is automatically activated when the vehicle is switched off, and deactivated when the vehicle is switched on.

When leaving the vehicle, always take the SmartKey with you and lock the vehicle. Anyone can start the vehicle if a valid SmartKey has been left inside the vehicle.

- i** In the event the engine cannot be started (yet the vehicle's battery is charged), the system is not operational. Contact an authorized Mercedes-Benz Center or call 1-800-FOR-MERCEdes (in the USA) or 1-800-387-0100 (in Canada).

### ATA (anti-theft alarm system)

#### Function of the ATA system

If the ATA system is armed, a visual and audible alarm is triggered in the following situations:

- When a door is opened
- When the trunk lid is opened
- When the hood is opened

- When the interior motion sensor is triggered (→ page 82)
- When the tow-away alarm is triggered (→ page 82)

The ATA system is armed automatically after approximately ten seconds in the following situations:

- After locking the vehicle with the SmartKey
- After locking the vehicle using KEYLESS-GO

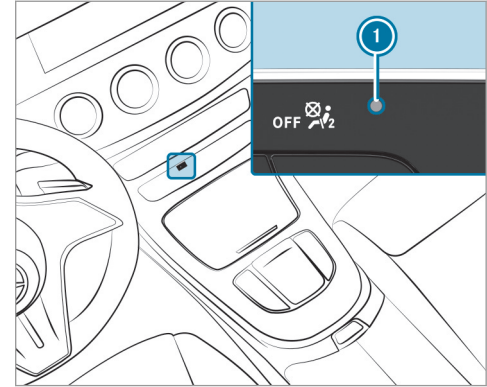

Indicator lamp **1** flashes when the ATA system is armed.

The ATA system is deactivated automatically in the following situations:

- After unlocking the vehicle with the SmartKey
- After unlocking the vehicle using KEYLESS-GO
- After pressing the start/stop button with the SmartKey in the marked space (→ page 136)

- ⓘ When the Mercedes-Benz emergency call system is active and the alarm stays on for more than 30 seconds, a message is automatically sent to the Customer Assistance Center (→ page 257).
- ⓘ In the case of severe battery discharging, the anti-theft alarm system is automatically deactivated to facilitate the next engine start.

### Deactivating the ATA

▶ Press the ,  or  button on the SmartKey.

or

▶ Press the start/stop button with the SmartKey in the stowage compartment (→ page 136)

### Deactivating the alarm using KEYLESS-GO

▶ Grasp the outside door handle with the SmartKey outside the vehicle.

### Function of the tow-away alarm

- ⓘ This function may not be available in all countries.

An audible and visual alarm is triggered if an alteration to your vehicle's angle of inclination is detected while the tow-away alarm is armed.



The tow-away alarm is automatically armed after approximately 60 seconds:

- After locking the vehicle with the SmartKey
- After locking the vehicle using KEYLESS-GO

The tow-away alarm is only armed when the following components are closed:

- Doors
- Trunk lid

The tow-away alarm is automatically deactivated:

- After pressing the  or  button on the SmartKey
- After pressing the start/stop button with the SmartKey in the marked space (→ page 136)
- After unlocking the vehicle using KEYLESS-GO
- When using HANDS-FREE ACCESS

Information on collision detection on a parked vehicle (→ page 161).

### Arming/disarming the tow-away alarm

Multimedia system:

  **▶ Settings ▶ Quick Access**

▶ Arm or disarm **Tow-away Protection**.

The tow-away alarm is armed again in the following cases:

- The vehicle is unlocked again.
- A door is opened.
- The vehicle is locked again.

- ⓘ If quick access is unavailable, select the **Vehicle** submenu in the **Settings** main menu to arm or disarm the tow-away alarm.

### Function of the interior motion sensor

- ⓘ This function may not be available in all countries.

When the interior motion sensor is activated, a visual and audible alarm is triggered if movement is detected in the vehicle interior.



The interior motion sensor is activated automatically after approximately ten seconds:

- After locking the vehicle with the SmartKey
- After locking the vehicle using KEYLESS-GO

The interior motion sensor is only activated when the following components are closed:

- Doors
- Trunk lid

The interior motion sensor is automatically deactivated:

- After pressing the  or  button on the SmartKey
- After pressing the start/stop button with the SmartKey in the marked space (→ page 136)
- After unlocking the vehicle using KEYLESS-GO
- When using HANDS-FREE ACCESS

The following situations can lead to a false alarm:

- When there are moving objects such as mascots in the vehicle interior
- When a side window is open

- When a sliding sunroof is open

### Arming/deactivating the interior motion sensor

Multimedia system:

  **▶▶ Settings ▶▶ Quick Access**

 Activate or deactivate **Interior Motion Sensor**.

The interior motion sensor is activated again in the following cases:

- The vehicle is unlocked again.
  - A door is opened.
  - The vehicle is locked again.
-  If quick access is unavailable, select the **Vehicle** menu under **Settings** to activate or deactivate the interior motion sensor.

### Notes on the correct driver's seat position

**⚠ WARNING** Risk of accident due to adjusting the vehicle settings while the vehicle is in motion

You could lose control of the vehicle in the following situations in particular:

- If you adjust the driver's seat, the head restraint, the steering wheel or the mirror while the vehicle is in motion
  - If you fasten your seat belt while the vehicle is in motion
- Before starting the vehicle: in particular, adjust the driver's seat, head restraint, steering wheel and mirror, and fasten your seat belt.

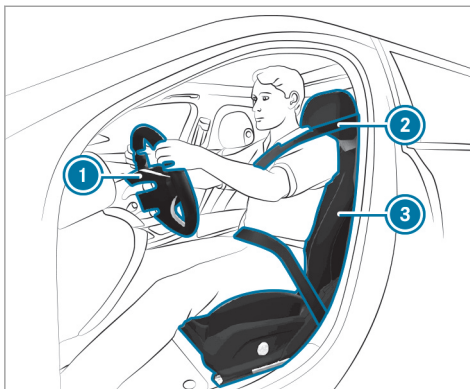

Ensure the following when adjusting the steering wheel ①, seat belt ② and driver's seat ③:

- You are sitting as far away from the driver's airbag as possible, taking the following points into consideration:
- You are sitting in an upright position
- Your thighs are slightly supported by the seat cushion

- Your legs are not fully extended and you can depress the pedals properly
- The back of your head is supported at eye level by the center of the head restraint
- You can hold the steering wheel with your arms slightly bent
- You can move your legs freely
- You can see all the displays on the instrument cluster clearly
- You have a good overview of the traffic conditions
- Your seat belt sits snugly against your body and passes across the center of your shoulder and across your hips in the pelvic area

### Seats

#### Adjusting the front seat manually and electrically

**⚠ WARNING** Risk of becoming trapped if the seats are adjusted by children

Children could become trapped if they adjust the seats, particularly when unattended.



- ▶ When leaving the vehicle, always take the SmartKey with you and lock the vehicle.
- ▶ Never leave children unattended in the vehicle.

You can adjust the seats when the ignition is switched off.

**⚠ WARNING** Risk of becoming trapped when adjusting the seat

When you adjust a seat, you or other vehicle occupants could become trapped, e.g. on the seat guide rail.

- ▶ When adjusting a seat, make sure that no one has any part of their body within the sweep of the seat.

Observe the safety notes on "Airbags" and "Children in the vehicle".

**⚠ WARNING** Risk of accident due to the driver's seat not being engaged

The driver's seat may move unexpectedly while driving.

This could cause you to lose control of the vehicle.

- ▶ Always make sure that the driver's seat is engaged before starting the vehicle.

**⚠ WARNING** Risk of becoming trapped if the seat height is adjusted carelessly

If you adjust the seat height carelessly, you or other vehicle occupants could be trapped and thereby injured.

Children in particular could accidentally press the electrical seat adjustment buttons and become trapped.

- ▶ While moving the seats, make sure that hands or other body parts do not get under the lever assembly of the seat adjustment system.

**⚠ WARNING** Risk of injury due to head restraints not being installed or being adjusted incorrectly

If head restraints have not been installed or have not been adjusted correctly, there is an increased risk of injury in the head and neck area, e.g. in the event of an accident or when braking.

- ▶ Always drive with the head restraints installed.
- ▶ Before driving off, make sure for every vehicle occupant that the center of the head restraint supports the back of the head at about eye level.

Do not interchange the head restraints of the front and rear seats. Otherwise, you will not be able to adjust the height and angle of the head restraints correctly.

Adjust the head restraint fore-and-aft position so that it is as close as possible to the back of your head.

**⚠ WARNING** Risk of injury or death due to an incorrect seat position

The seat belt does not offer the intended level of protection if you have not moved the seat backrest to an almost vertical position.

In particular, you could slip beneath the seat-belt and become injured.

- ▶ Adjust the seat properly before beginning your journey.
- ▶ Always ensure that the seat backrest is in an almost vertical position and that the shoulder belt is routed across the center of your shoulder.

**⚠ WARNING** Risk of injury or death due to objects under the co-driver seat

Objects trapped under the co-driver seat can interfere with the function of the automatic co-driver airbag shutoff or damage the system.

- ▶ Do not store any objects under the co-driver seat.

- ▶ When the co-driver seat is occupied, make sure that no objects are trapped under the co-driver seat.

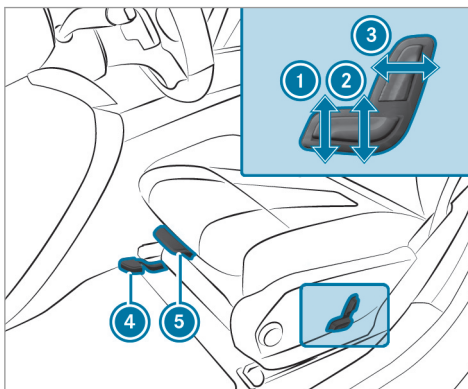

- ① Seat cushion inclination
- ② Seat height
- ③ Seat backrest inclination

- ④ Seat fore-and-aft position
- ⑤ Seat cushion length

- ▶ **To adjust the seat fore-and-aft position:** lift lever ④ and slide the seat into the desired position.
- ▶ Make sure that the seat is engaged.
- ▶ **To adjust the seat cushion length:** lift lever ⑤ and slide the front section of the seat cushion forwards or backwards.

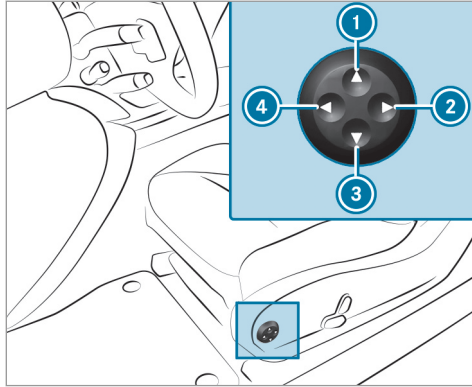

- ① Higher
- ② Softer
- ③ Lower
- ④ Firmer

▶ **To adjust the 4-way lumbar support:** Using buttons ① to ④, adjust the contour of the backrest individually to suit your back.

### Adjusting the front seat electrically

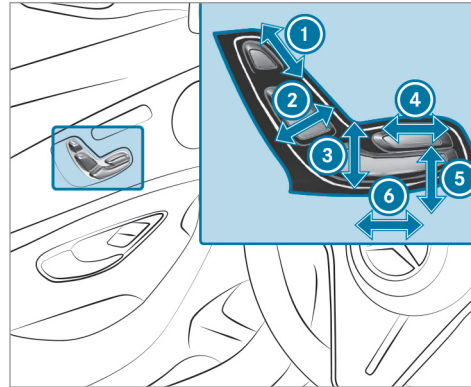

- ① Head restraint height
- ② Seat backrest inclination
- ③ Seat height
- ④ Seat cushion length
- ⑤ Seat cushion inclination
- ⑥ Seat fore-and-aft position

▶ Save the settings with the memory function (→ page 96).

### Head restraints

#### Adjusting the front seat head restraints manually

**⚠ WARNING** Risk of accident due to adjusting the vehicle settings while the vehicle is in motion

You could lose control of the vehicle in the following situations in particular:

- If you adjust the driver's seat, the head restraint, the steering wheel or the mirror while the vehicle is in motion
- If you fasten your seat belt while the vehicle is in motion

▶ Before starting the vehicle: in particular, adjust the driver's seat, head restraint, steering wheel and mirror, and fasten your seat belt.

**⚠ WARNING** Risk of injury due to head restraints not being installed or being adjusted incorrectly

If head restraints have not been installed or have not been adjusted correctly, there is an increased risk of injury in the head and neck area, e.g. in the event of an accident or when braking.

- ▶ Always drive with the head restraints installed.
- ▶ Before driving off, make sure for every vehicle occupant that the center of the head restraint supports the back of the head at about eye level.

Do not interchange the head restraints of the front and rear seats. Otherwise, you will not be able to adjust the height and angle of the head restraints correctly.

Adjust the head restraint fore-and-aft position so that it is as close as possible to the back of your head.

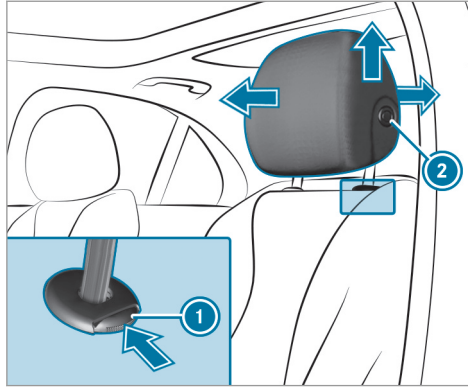

- ▶ **To raise:** pull the head restraint up.
- ▶ **To lower:** press release knob ❶ in the direction of the arrow and push the head restraint down.
- ▶ **To move forwards:** pull the head restraint forwards.
- ▶ **To move backwards:** press release knob ❷ and push the head restraint backwards.

#### Adjusting the head restraints of the rear seats mechanically

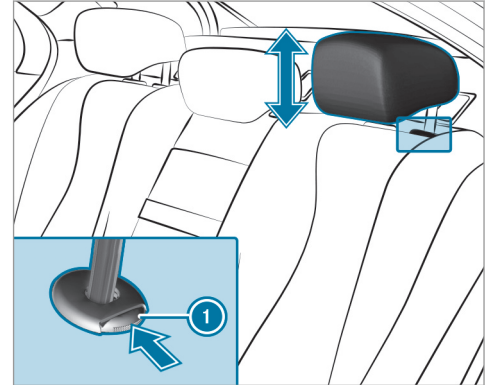

- ▶ **To raise:** pull the head restraint up.
- ▶ **To lower:** press release knob ❶ in the direction of the arrow and push the head restraint down.

## Configuring the seat settings

Multimedia system:

→  » [Comfort](#) » [Seat Comfort](#)

### Adjusting the backrest contour in the lumbar region of the seat backrest (lumbar)

- ▶ Select [Lumbar](#).
- ▶ Select the settings  for the desired seat.
- ▶ Adjust the air cushions.

### Adjusting the backrest side bolsters

- ▶ Select [Side Bolsters](#).
- ▶ Adjust the air cushion for the desired seat.

### Setting the seat heating balance

- ▶ Select [Seat Heating Balance](#).
- ▶ Adjust the heat distribution for the desired seat.

## Setting automatic seat adjustment

**⚠ WARNING** Risk of becoming trapped during adjustment of the driver's seat after calling up a driver profile

Selecting a user profile may trigger an adjustment of the driver's seat to the position saved under the user profile. You or other vehicle occupants could be injured in the process.

- ▶ Make sure that when the position of driver's seat is being adjusted using the multimedia system, no people or body parts are in the seat's range of movement.

If there is a risk of someone becoming trapped, stop the adjustment process immediately:

- ▶ a) Tap the warning message on the media display.
- or
- ▶ b) Press a memory position button or a seat adjustment switch on the driver's door.
- The adjustment process will be stopped.

### Requirements:

- Adapting the driver's seat position to body size: automatic seat adjustment has been switched on.

Multimedia system:

→  » [Settings](#) » [Vehicle](#)  
▶ [Automatic Seat Adjustment](#)

### Switching automatic seat adjustment on/off

When the active user profile is changed while the vehicle is stationary, the driver's seat, outside mirrors and seat contour will automatically be adapted to the driver.

- ▶ Select [On](#) or [Off](#).

**i** This setting is available only for individual user profiles. For the guest profile, automatic seat adjustment cannot be switched on or off.

### Adjusting the driver's seat position to body size

The vehicle will calculate a suitable driver's seat position on the basis of the driver's body size and set this directly.

- ▶ **To set the unit of measurement:** select [cm](#) or [ft/in](#).

- ▶ Set the size using the scale.
- ▶ Select **Start Positioning**.  
The driver's seat position will be adjusted to the body size that has been set.
- ① If the driver's seat position calculated by the vehicle is not practical or comfortable, it can be changed manually at any time via the buttons.  
The exterior mirrors are not set via this function. Instead, they have to be set manually via the switches.
- ① You can also configure these settings via the Mercedes me portal for your user profile. By synchronizing the profiles in the vehicle and the Mercedes me connect profiles, you can carry over these settings for your vehicle. Further information about synchronizing user profiles .

### Setting the easy entry and exit feature

- ▶ Switch the function on or off.
- ① If you use an individual user profile and have set your body size, this information is carried over for the easy entry and exit feature. This

causes the driver's seat to automatically move into the correct position .

### Overview of massage programs

- **Hot Relaxing Back** Combination of heat and massage. It starts by massaging the back. In addition, warm pressure points become noticeable, starting in the pelvic area.
- **Hot Relaxing Shoulder** Combination of heat and massage. It starts by massaging the shoulders. In addition, warm pressure points become noticeable, starting in the pelvic area.
- **Activating Massage** Activating massage with upward-moving massage waves.
- **Classic Massage** Relaxing back massage.
- **Wave Massage** Regenerating massage via massage waves across the back and in the seat cushion.
- **Mobilizing Massage** Mobilizing massage with upward-moving massage waves. Can promote slower, deeper respiration. This can improve the supply of oxygen to cells and the brain.

- **Active Workout, Backrest** and **Active Workout, Cushion**: These programs require your cooperation. Alternating between tensing and releasing helps to improve blood flow to your muscles. Press against a pressure point as soon as you feel it.

### Selecting the massage program for the front seats

Multimedia system:

→  ▶▶ **Comfort** ▶▶ **Massage**

- ▶ Start the program for the desired seat .
- ▶ **To set the message intensity**: switch **High Intensity** on or off .

### Resetting seat settings

Multimedia system:

→  ▶▶ **Comfort** ▶▶ **Seat Comfort**

- ▶ Select  for the desired seat.
- ▶ Confirm the prompt.

### Switching the seat heating on/off

**⚠ WARNING** Risk of burns due to repeatedly switching on the seat heating

Repeatedly switching on the seat heating can cause the seat cushion and seat backrest padding to become very hot.

In particular, the health of persons with limited temperature sensitivity or a limited ability to react to high temperatures may be affected or they may even suffer burn-like injuries.

- ▶ Do not repeatedly switch on the seat heating.

To protect against overheating, the seat heating may be temporarily deactivated after it has been switched on repeatedly.

**! NOTE** Damage to the seats caused by objects or documents when the seat heating is switched on

When the seat heating is switched on, overheating may occur due to objects or docu-

ments placed on the seats, e.g. seat cushions or child seats. This could cause damage to the seat surface.

- ▶ Make sure that no objects or documents are on the seats when the seat heating is switched on.

#### Requirements:

- The power supply is switched on.

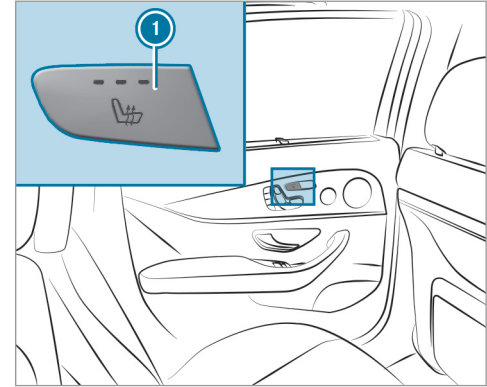
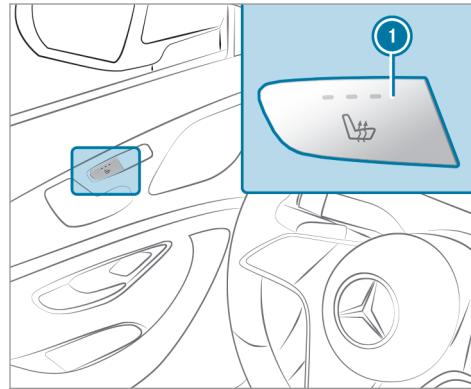

- ▶ Press button ① repeatedly until the desired heating level is set. Depending on the heating level, up to three indicator lamps will light up. If all indicator lamps are off, the seat heating is switched off.
- ⓘ The seat heating will automatically switch down from the three heating levels after 8, 10 and 20 minutes until the seat heating is switched off.

- ⓘ Vehicles with the Warmth Comfort Package: you can heat the armrests in the door and the center console. You can also set the panel heating in the multimedia system (→ page 92).

### Setting the panel heating

Multimedia system:

-  » Settings » Vehicle
- » Panel Heating

When the seat heating is switched on, the armrests and the center console can be heated.

- ▶ Switch the function for the desired seats on or off.

### Switching the seat ventilation on/off

Requirements:

- The power supply is switched on.

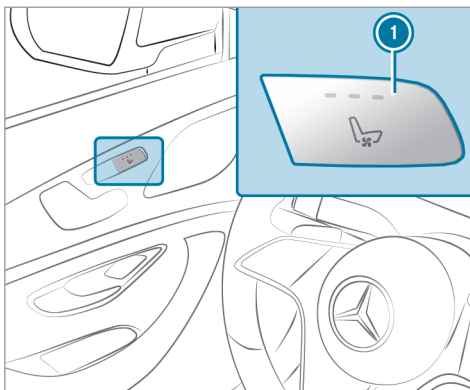

- ▶ Press button ① repeatedly until the desired blower setting has been reached. Depending on the blower setting, up to three indicator lamps will light up. If all indicator lamps are off, the seat ventilation is switched off.

### Steering wheel

#### Adjusting the steering wheel manually

- ⚠ **WARNING** Risk of accident due to adjusting the vehicle settings while the vehicle is in motion

You could lose control of the vehicle in the following situations in particular:

- If you adjust the driver's seat, the head restraint, the steering wheel or the mirror while the vehicle is in motion
- If you fasten your seat belt while the vehicle is in motion

- ▶ Before starting the vehicle: in particular, adjust the driver's seat, head restraint, steering wheel and mirror, and fasten your seat belt.

- ⚠ **WARNING** Risk of entrapment for children when adjusting the steering wheel

Children could injure themselves if they adjust the steering wheel.



- ▶ Never leave children unattended in the vehicle.
- ▶ When leaving the vehicle, always take the SmartKey with you and lock the vehicle.

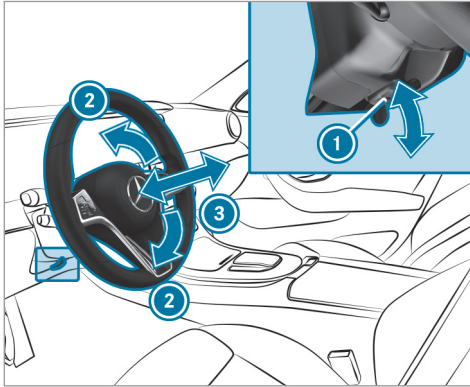

- ▶ **To unlock:** push release lever ① down as far as it will go.
- ▶ Adjust height ② and distance ③ to the steering wheel.

### Locking

- ▶ Fold release lever ① up as far as it will go.
- ▶ Check and make sure that the steering column is locked by moving the steering wheel.

### Adjusting the steering wheel electrically

The steering wheel can be adjusted when the power supply is disconnected.

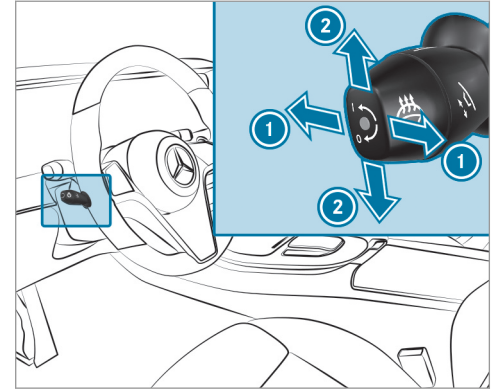

- ① To adjust the distance to the steering wheel
- ② To adjust the height
- ▶ Save the settings with the memory function (→ page 96).

### Switching the steering wheel heater on/off

#### Requirements:

- The power supply or the ignition is switched on.

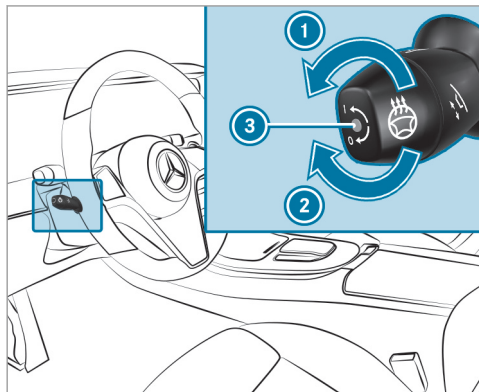

- ▶ Turn the lever in the direction of arrow ① or ②.  
If indicator lamp ③ lights up, the steering wheel heater is switched on.

When you switch the ignition off, the steering wheel heater will switch off.

### Easy entry and exit feature

#### Using the easy entry and exit feature

- ⚠ **WARNING** Risk of accident when pulling away during the adjustment process of the easy entry and exit feature

You could lose control of the vehicle.

- ▶ Always wait until the adjustment process is complete before driving off.

- ⚠ **WARNING** Risk of becoming trapped during adjustment of the easy entry and exit feature

You and other vehicle occupants – particularly children – could become trapped.

- ▶ Ensure that no one has a body part in the sweep of the steering wheel or driver's seat.

If there is a risk of becoming trapped by the steering wheel:

- ▶ Move the adjustment lever of the steering wheel.  
The adjustment process will be stopped.

If there is a risk of becoming trapped by the driver's seat:

- ▶ Press the seat adjustment switch.  
The adjustment process will be stopped.
- ▶ Never leave children unattended in the vehicle.
- ▶ When leaving the vehicle, always take the SmartKey with you and lock the vehicle.

**Vehicles with memory function:** You can stop the adjustment process by pressing one of the memory function position switches.

**⚠ WARNING** Risk of becoming trapped if children activate the easy entry and exit feature-

Children could become trapped if they activate the easy entry- and exit feature, particularly when unattended.

- ▶ Never leave children unattended in the vehicle.
- ▶ When leaving the vehicle, always take the SmartKey with you and lock the vehicle.

If the easy entry and exit feature is active, the steering wheel will move upwards and the driver's seat will move back in the following situations:

- You switch off the vehicle when the driver's door is open.
  - You open the driver's door when the vehicle is switched off.
- i** The steering wheel will then move upwards only if it is not already as high as it will go. The driver's seat will then move backwards only if it is not already at the rear of the seat adjustment range.

The steering wheel and the driver's seat will move back to the last drive position in the following cases:

- You switch the power supply or the vehicle on when the driver's door is closed
- You close the driver's door when the vehicle is switched on.

The last drive position will be saved when:

- You switch off the vehicle.
- **Vehicles with memory function:** You call up the seat settings via the memory function.
- **Vehicles with memory function:** You save the seat settings via the memory function.

**Vehicles with memory function:** Press one of the memory function position buttons to stop the adjustment process.

### Setting the easy entry and exit feature

Multimedia system:

- ▶  ▶ Settings ▶ Vehicle
- ▶▶ Automatic Seat Adjustment
- ▶▶ Easy Entry/Exit
- ▶ Activate or deactivate the function.

### Memory function

#### Function of the memory function

**⚠ WARNING** Risk of an accident if the memory function is used while driving

If you use the memory function on the driver's side while driving, you could lose control of the vehicle as a result of the adjustments being made.

- ▶ Only use the memory function on the driver's side when the vehicle is stationary.

**⚠ WARNING** Risk of entrapment when adjusting the seat with the memory function

When the memory function adjusts the seat, you and other vehicle occupants – particularly children – could become trapped.

- ▶ During the adjustment process of the memory function, make sure that no one has any body parts in the sweep of the seat.
- ▶ If someone becomes trapped, press a preset position button or seat adjustment switch immediately.

**⚠ WARNING** Risk of entrapment if the memory function is activated by children

Children could become trapped if they activate the memory function, particularly when unattended.

- ▶ Never leave children unattended in the vehicle.

- ▶ When leaving the vehicle, always take the SmartKey with you and lock the vehicle.

You can use the memory function when the vehicle is switched off.

Seat adjustments for up to three people can be stored and called up using the memory function.

You can save settings for the following systems:

- Seat, backrest and head restraint
- Steering wheel
- Outside mirrors
- Head-up Display

## Operating the memory function

### Storing

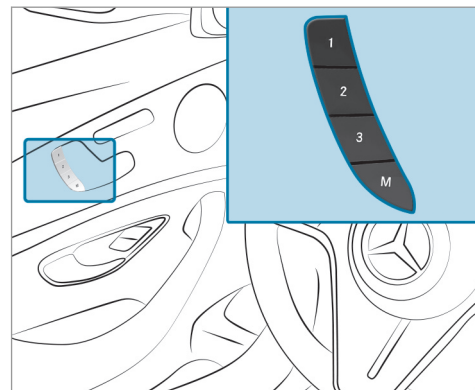

- ▶ Set the desired position for all systems.
- ▶ Briefly press the **[M]** memory button and then press preset position button **[1]**, **[2]** or **[3]** within three seconds. An acoustic signal sounds. The settings are stored.

- ▶ **To call up:** press or briefly hold preset position button **1**, **2** or **3**.  
After releasing the button, all systems are moved into the stored position.

### Stowage areas

#### Notes on loading the vehicle

#### **⚠ DANGER** Risk of exhaust gas poisoning

Combustion engines emit poisonous exhaust gases such as carbon monoxide. Exhaust gases can enter the vehicle interior if the trunk lid is open when the vehicle is running, especially if the vehicle is in motion.

- ▶ Always switch off the vehicle before opening the trunk lid.
- ▶ Never drive with the trunk lid open.

#### **⚠ WARNING** Risk of injury from unsecured items in the vehicle

If objects, luggage or loads are not secured or not secured sufficiently, they could slip, tip

over or be thrown around and thereby hit vehicle occupants.

There is a risk of injury, particularly in the event of sudden braking or a sudden change in direction.

- ▶ Always stow objects in such a way that they cannot be thrown around.
- ▶ Before the journey, secure objects, luggage or loads against slipping or tipping over.

#### **⚠ WARNING** Risk of injury due to objects being stowed incorrectly

If objects in the vehicle interior are stowed incorrectly, they can slide or be thrown around and hit vehicle occupants. In addition, cup holders, open storage spaces and mobile phone brackets cannot always retain all objects they contain.

There is a risk of injury, particularly in the event of sudden braking or a sudden change in direction.

- ▶ Always stow objects in such a way that they cannot be thrown around in such situations.
- ▶ Always make sure that objects do not protrude from storage spaces, parcel nets or storage nets.
- ▶ Close the lockable storage spaces before starting a journey.
- ▶ Always stow and secure heavy, hard, pointed, sharp-edged, fragile or bulky objects in the trunk.

#### **Vehicles with automatic front passenger airbag shutoff:**

Objects trapped under the front passenger seat may interfere with the function of the automatic front passenger airbag shutoff or damage the system. Please observe the notes on the function of the automatic front passenger airbag shutoff (→ page 42).

**⚠ WARNING** - Risk of accident or injury when using the cup holder while the vehicle is moving

The cup holder cannot secure containers while the vehicle is moving.

If you use a cup holder while the vehicle is moving, the container may be flung around and liquids may be spilled. The vehicle occupants may come into contact with the liquid and if it is hot, they could be scalded. You could be distracted from traffic conditions and you may lose control of the vehicle.

- ▶ Only use the cup holder when the vehicle is stationary.
- ▶ Only use the cup holder for containers of the right size.
- ▶ Close the container, particularly if the liquid is hot.

**! NOTE** Damage to the cup holder

When the rear armrest is folded back the cup holder could become damaged.

- ▶ Only fold the rear armrest back when the cup holder is closed.

**! NOTE** Damage to the rear armrest due to body weight

When folded out, the rear armrest can be damaged by body weight.

- ▶ Do not sit or support yourself on the rear seat armrest.

**! NOTE** Damage to the handle in the trunk floor

If the handle in the trunk is left protruding, the handle may be damaged.

- ▶ Before closing the trunk lid, detach the handle and press it down closed again.

**! NOTE** Damage to the stowage compartment under the ashtray due to intense heat

The stowage compartment under the ashtray is not heat resistant and could be damaged if you rest a lit cigarette on it.

- ▶ Make sure that the ashtray is fully engaged.

**⚠ WARNING** - Risk of fire and injury from hot cigarette lighter

You can burn yourself if you touch the hot heating element or the socket of the cigarette lighter.

In addition, flammable materials may ignite if:

- you drop the hot cigarette lighter
- a child holds the hot cigarette lighter to objects, for example

- ▶ Always hold the cigarette lighter by the knob.

- ▶ Always make sure that the cigarette lighter is out of reach of children.
- ▶ Never leave children unattended in the vehicle.

**⚠ WARNING** Risk of burns from the tailpipe and tailpipe trims

The exhaust tailpipe and tailpipe trims can become very hot. If you come into contact with these parts of the vehicle, you could burn yourself.

- ▶ Always be particularly careful around the tailpipe and the tailpipe trims and supervise children especially closely in this area.
- ▶ Allow vehicle parts to cool down before touching them.

The driving characteristics of your vehicle are dependent on the distribution of the load within the vehicle. You should bear the following in mind when loading the vehicle:

- Never exceed the permissible gross mass or the gross axle weight rating for the vehicle (including occupants). The values are specified on the vehicle identification plate on the vehicle's B-pillar.
- The load must not protrude above the upper edge of the seat backrests.
- Always place the load behind unoccupied seats if possible.
- Secure the load using the tie-down eyes and distribute the load evenly.

Notes on driving with a roof load

- Evenly distribute the roof load, and place heavy objects at the bottom. Also comply with the notes on loading the vehicle (→ page 97).
- Drive attentively, and avoid suddenly pulling away, braking and steering as well as rapid cornering.

- When transporting roof loads and when the vehicle is fully loaded or fully occupied, select drive programs **[E]** and **[C]**. These are designed to focus on stability (→ page 146).
- ④ For more information on stowage compartments and stowage areas, please refer to the Digital Operator's Manual.

## Stowage spaces in the vehicle interior

### Overview of the front stowage compartments

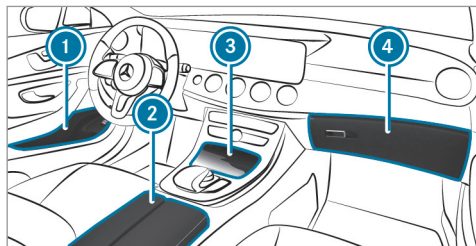

- 1 Stowage spaces in the doors
- 2 Stowage compartment in the armrest with USB ports and stowage space, e.g. for an MP3 player
- 3 Stowage compartment in the front center console with a USB port
- 4 Glove box

## Through-loading feature in the rear bench seat (EASY-PACK Quickfold)

### Folding the rear seat backrest forwards

**⚠ WARNING** Risk of becoming trapped when adjusting the seats

When you adjust a seat, you may trap yourself or a vehicle occupant.

- ▶ When adjusting a seat, make sure that no one has any body parts in the sweep of the seat.

**⚠ WARNING** Risk of accident and injury if the rear bench seat/rear seat and seat backrest are not engaged

Rear bench seat, rear seat and seat backrest can fold forwards.

- As a result, the vehicle occupant is pressed against the seat belt. The seat belt cannot perform its intended protective function and could cause additional injuries.

- Objects or loads in the trunk cannot be restrained by the seat backrest.

- ▶ Make sure that the rear bench seat, the rear seat and the seat backrest are engaged before every trip.

If the left and right seat backrests are not engaged and locked in place, this will be shown on the multifunction display on the instrument cluster. If the center seat backrest is not engaged and locked in place, the red lock verification indicator will be visible.

Always ensure that all vehicle occupants have their seat belts fastened correctly and are sitting properly. Particular attention must be paid to children.

If you no longer require the folded-down seat backrest as a loading area, fold the backrest back into place.

#### Requirements:

- The area into which the seat backrest is folded is clear.



- The rear seat backrest head restraints are fully inserted.

### Folding the left and right seat backrests forwards

You can fold the center and outer seat backrests forwards separately.

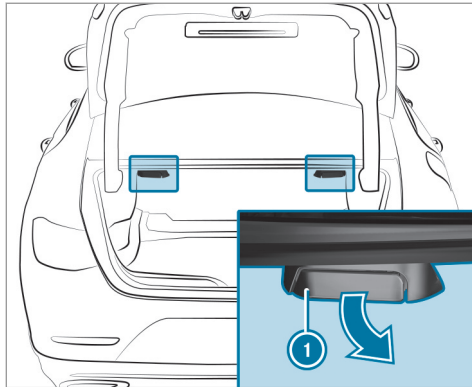

- ▶ **Vehicles with a memory function:** If at least one section of the rear seat backrest is folded forwards, the corresponding front seat will

move forwards slightly, if necessary, to avoid a collision.

- ▶ If necessary, fully insert the head restraints in the rear seat backrest.
- ▶ Pull release lever (1).  
The corresponding seat backrest will fold forwards.

### Folding the center seat backrest forwards

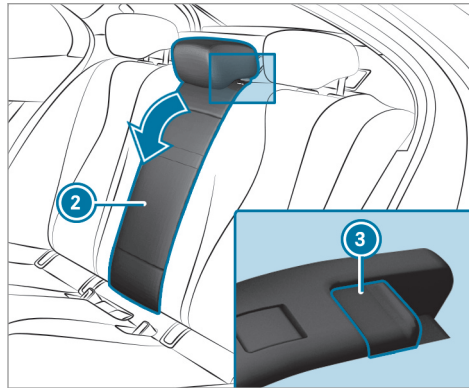

Ensure that the center seat backrest has been unlocked.

- ▶ Pull release catch (3) for seat backrest (2) forwards.
- ▶ Fold the corresponding seat backrest forwards.

### Folding back the rear seat backrest

**⚠ WARNING** Risk of becoming trapped when adjusting the seats

When you adjust a seat, you may trap yourself or a vehicle occupant.

- ▶ When adjusting a seat, make sure that no one has any body parts in the sweep of the seat.

**! NOTE** Damage caused by trapping the seat belt when folding back the seat backrest

The seat belt could become trapped and thus damaged when the seat backrest is folded back.

- ▶ Make sure that the seat belt is not trapped when folding back the seat backrest.

- ▶ **Vehicles with a memory function:** If at least one section of the seat backrest is folded back, the corresponding front seat will automatically return to the most recent original position.

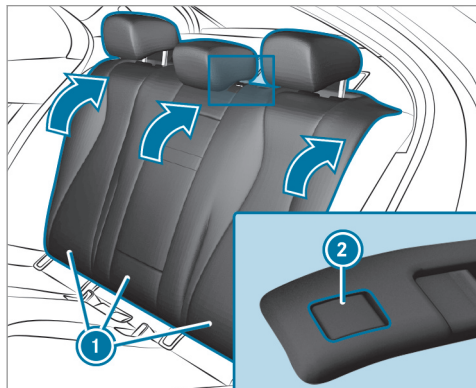

- ▶ Fold the corresponding seat backrest ① back until it engages.

**Left and right seat backrests:** if the seat backrest is not engaged and locked in place, this will be shown on the multifunction display on the instrument cluster.

**Center seat backrest:** if the seat backrest is not engaged and locked in place, the red lock verification indicator ② will be visible.

#### Locking the release catch of the center rear seat backrest

##### Requirements:

- The left and center seat backrests are engaged and joined together.

You can lock the center seat backrest release catch if you want to secure the trunk against unauthorized access. The center seat backrest can then be folded forwards only together with the left seat backrest.

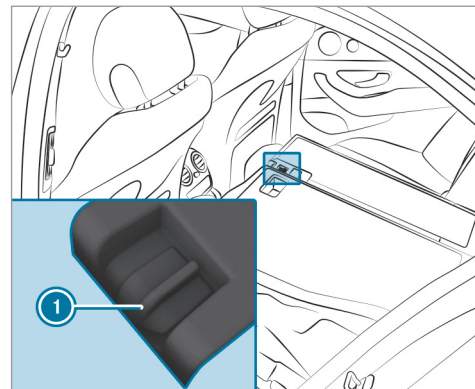

- ▶ Fold the center and left seat backrests forwards.
- ▶ **To lock or unlock:** slide catch ① upwards or downwards.

#### Overview of the tie-down eyes

Observe the notes on loading the vehicle (→ page 97).

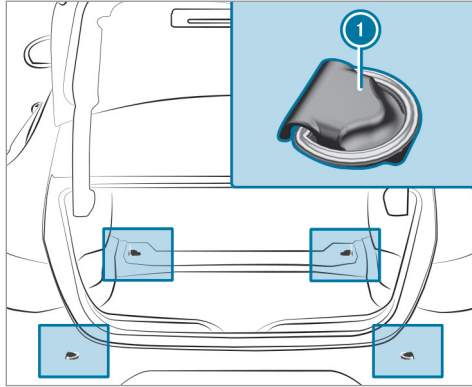

- ① Tie-down eyes (vehicles with through-loading feature in the rear bench seat)

### Using the bag hooks

**⚠ WARNING** Risk of injury when using bag hooks with heavy objects

The bag hooks cannot restrain heavy objects or items of luggage.

Objects or items of luggage may be flung around and hit vehicle occupants.

- ▶ Only hang light objects on the bag hooks.
- ▶ Never hang hard, sharp-edged or fragile objects on the bag hooks.

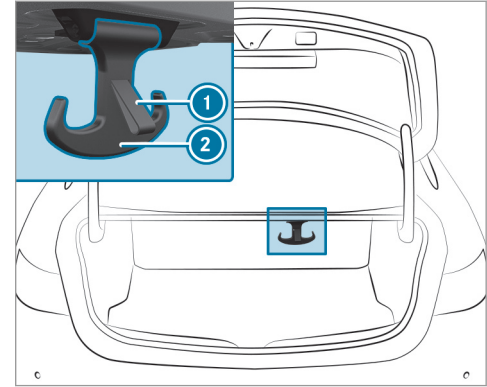

- ▶ Pull bag hook ② down by tab ①.
- ⓘ Observe the notes on loading the vehicle (→ page 97).

### Attaching the parcel net

**⚠ WARNING** Risk of injury due to objects being stowed incorrectly

If objects in the vehicle interior are stowed incorrectly, they can slide or be thrown around and hit vehicle occupants. In addition, cup holders, open storage spaces and mobile phone brackets cannot always retain all objects they contain.

There is a risk of injury, particularly in the event of sudden braking or a sudden change in direction.

- ▶ Always stow objects in such a way that they cannot be thrown around in such situations.
- ▶ Always make sure that objects do not protrude from storage spaces, parcel nets or storage nets.
- ▶ Close the lockable storage spaces before starting a journey.

- ▶ Always stow and secure heavy, hard, pointed, sharp-edged, fragile or bulky objects in the trunk.

Observe the notes on loading the vehicle.

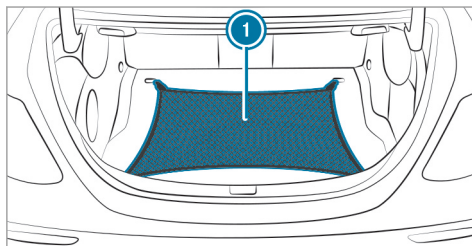

- ▶ Vehicles with through-loading feature in the rear bench seat: fold up the tie-down eyes.
- ▶ Hook parcel net ① into the front and rear tie-down eyes.
- ▶ Vehicles without a through-loading feature in the rear bench seat: hook the rings into the parcel net hooks ①.

- ▶ Place the rings into the hooks on the trunk floor.

### Attaching a roof luggage rack

**⚠ WARNING** Risk of accident due to exceeding the maximum roof load

The vehicle center of gravity and the usual driving characteristics as well as the steering and braking characteristics alter.

If you exceed the maximum roof load, the driving characteristics, as well as steering and braking, will be greatly impaired.

- ▶ Never exceed the maximum roof load and adjust your driving style.

You will find information on the maximum roof load in the "Technical data" section.

**!** **NOTE** Damage to the vehicle due to not observing the maximum permitted headroom clearance

If the vehicle height is greater than the maximum permitted headroom clearance, the roof and other parts of the vehicle may be damaged.

- ▶ Observe the signposted headroom clearance.
- ▶ If the vehicle height is greater than the permitted headroom clearance, do not enter.
- ▶ Observe the changed vehicle height with add-on roof equipment.

**!** **NOTE** Vehicle damage from non-approved roof luggage racks

The vehicle could be damaged by roof luggage racks that have not been tested and approved for Mercedes-Benz.

- ▶ Use only roof luggage racks tested and approved for Mercedes-Benz.

- ▶ Depending on the vehicle equipment, ensure that the sliding sunroof can be fully raised when the roof luggage rack is installed.
- ▶ Depending on the vehicle equipment, ensure that the trunk lid can be fully opened when the roof luggage rack is installed.
- ▶ Position the load on the roof luggage rack in such a way that the vehicle will not sustain damage even when it is in motion.

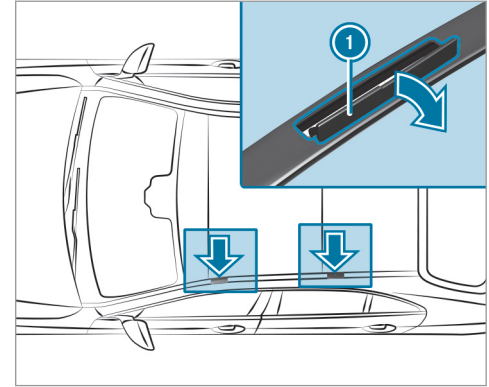

**!** **NOTE** Damage to the covers

The covers may be damaged and scratched when being opened.

- ▶ Do not use metallic or hard objects.

- ▶ Carefully fold covers ① upwards in the direction of the arrow.

- ▶ Secure the roof luggage rack to the fastening points beneath covers ❶.
- ▶ Comply with the installation instructions of the roof luggage rack manufacturer.
- ▶ Secure the load on the roof luggage rack.

## Sockets

### Using the 12 V socket

#### Requirements:

- Only connect devices up to a maximum of 180 W (15 A).

Depending on the vehicle equipment, the vehicle has a 12 V socket in the storage compartment in the front center console. In addition, depending on the vehicle equipment, the vehicle has a 12 V socket in the storage compartment in the rear passenger compartment center console.

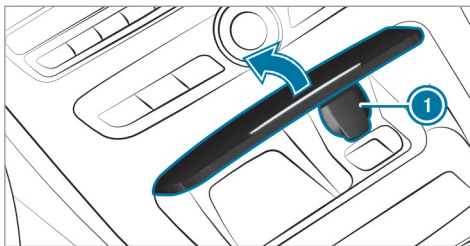

Example: 12 V socket in the storage compartment in the front center console

- ▶ Briefly press the trim element of the cover on the front. The cover opens in the direction of the arrow.
- ▶ Lift up cap ❶ of the socket and insert the plug of the device.

If you have connected a device to the 12 V socket, leave the cover of the storage compartment open.

### Using the 115 V socket in the rear passenger compartment

**⚠ DANGER** Risk of fatal injuries due to a damaged connecting cable or a damaged socket

You could receive an electric shock if the connecting cable or the 115 V power socket is pulled out of the trim or is damaged or wet.

- ▶ Use only connecting cables that are dry and free of damage.
- ▶ When the vehicle is switched off, make sure that the 115 V power socket is dry.
- ▶ Immediately have the 115 V power socket checked or replaced at a qualified specialized workshop if it is damaged or has been pulled out of the trim.
- ▶ Never plug the connecting cable into a 115 V power socket that is damaged or has been pulled out of the trim.

**⚠ DANGER** Risk of death due to using the socket incorrectly

In particular, you could receive an electric shock:

- If you touch the inside of the socket
  - If you insert unsuitable devices or objects into the socket
- ▶ Do not touch the inside of the socket.
- ▶ Only connect suitable devices to the socket.

Make sure that no liquids get into the 115 V socket.

When the 115 V socket is not in use, keep the socket flap closed.

**Requirements:**

- The device is equipped with a suitable plug which conforms to the standards specific to the country you are in.
- A device up to a maximum of 150 W (1.3 A) is used.
- Do not use multiple socket outlets.

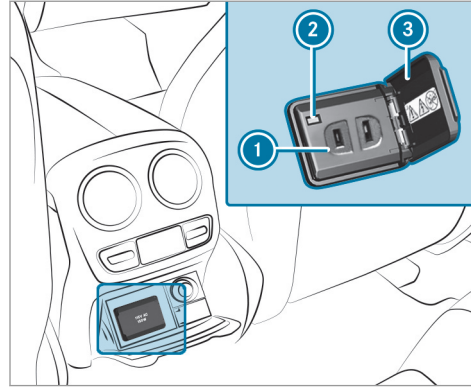

- ▶ Open socket flap ③.
  - ▶ Insert the plug of the device into 115 V socket ①.
- When the on-board electrical system voltage is sufficient, indicator lamp ② lights up.

**USB port in the rear passenger compartment**

ⓘ Depending on the vehicle equipment, the design of the storage compartment and the number of USB ports in the rear center console may vary.

When the vehicle is switched on, you can charge a USB device, such as a mobile phone, at the USB port using a suitable charging cable.

When the vehicle is switched on, the devices can be charged with 5 V (up to 3 A).

**Wireless charging of the mobile phone and connection with the exterior antenna**

**Notes on wirelessly charging the mobile phone**

**⚠ WARNING** Risk of injury due to objects being stowed incorrectly

If objects in the vehicle interior are stowed incorrectly, they can slide or be thrown around and hit vehicle occupants. In addition, cup holders, open stowage spaces and mobile phone receptacles cannot always retain all objects within.

There is a risk of injury, particularly in the event of sudden braking or a sudden change in direction.

- ▶ Always stow objects so that they cannot be thrown around in such situations.
- ▶ Always make sure that objects do not protrude from stowage spaces, parcel nets or stowage nets.
- ▶ Close the lockable stowage spaces before starting a journey.
- ▶ Always stow and secure heavy, hard, pointed, sharp-edged, fragile or bulky objects in the trunk/cargo compartment.

Observe the notes on loading the vehicle.

**⚠ WARNING** Risk of fire from placing objects in the mobile phone storage compartment

Placing other objects in the mobile phone storage compartment could constitute a fire hazard.

- ▶ Apart from a mobile phone, do not place any other objects in the mobile phone storage compartment, especially those made of metal.

**!** **NOTE** Damage to objects caused by placing them in the mobile phone storage compartment

If objects are placed in the mobile phone storage compartment, these may be damaged by electromagnetic fields.

- ▶ Do not place credit cards, storage media, ski passes or other objects sensitive to electromagnetic fields in the mobile phone storage compartment.

**!** **NOTE** Damage to the mobile phone storage compartment caused by liquids

If liquids enter the mobile phone storage compartment, the compartment may be damaged.

- ▶ Ensure that no liquids enter the mobile phone storage compartment.

The following notes on wirelessly charging the mobile phone must be observed:

- Depending on the vehicle equipment, the mobile phone is connected to the vehicle's exterior antenna via the charging module.
- The charging function and wireless connection of the mobile phone to the vehicle's exterior antenna are only available if the vehicle is switched on.
- Small mobile phones may not be able to be charged in every position of the mobile phone storage compartment.
- Large mobile phones which do not rest flat in the mobile phone storage compartment may not be able to be charged or connected with the vehicle's exterior antenna.
- The mobile phone may heat up during the charging process. This may particularly depend on the applications (apps) currently open in the background.
- To ensure more efficient charging and connection with the vehicle's exterior antenna, remove the protective cover from the mobile



phone. Protective covers which are necessary for wireless charging are an exception.

- When charging, the mat should be used if possible.

### Charging a mobile phone wirelessly

#### Requirements:

- The mobile phone is suitable for wireless charging (Qi-compatible mobile phone).

A list of Qi-compatible mobile phones can be found at: <https://www.mercedes-benz-mobile.com>.

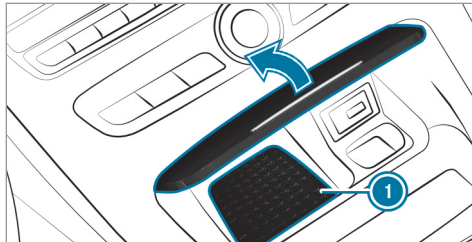

- ▶ Place the mobile phone as close to the center of mat ① as possible with the display facing upwards. When the charging symbol is shown in the multimedia system, the mobile phone is being charged.

Malfunctions during the charging process are shown in the central display.

- ① The mat can be removed for cleaning, e.g. using clean, lukewarm water.

### Installing/removing the floor mats

**▲ WARNING** Risk of accident due to objects in the driver's footwell

Objects in the driver's footwell may impede pedal travel or block a depressed pedal.

This jeopardizes the operating and road safety of the vehicle.

- ▶ Stow all objects in the vehicle securely so that they cannot get into the driver's footwell.

- ▶ Always install the floor mats securely and as prescribed in order to ensure that there is always sufficient room for the pedals.
- ▶ Do not use loose floor mats and do not place floor mats on top of one another.

### Installing floor mats

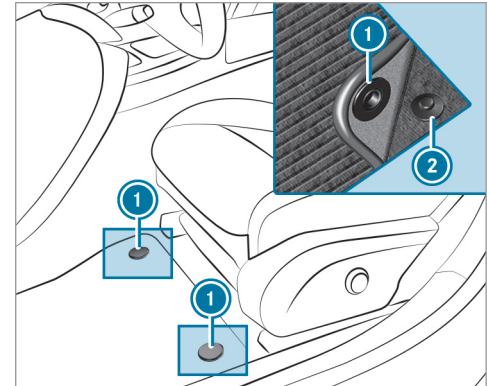

## 110 Seats and stowing

---

- ▶ Slide the corresponding seat backwards and lay the floor mat in the footwell.
- ▶ Press studs ❶ onto holders ❷.
- ▶ Adjust the corresponding seat.

### **Removing floor mats**

- ▶ Pull the floor mat off holders ❷.
- ▶ Remove the floor mat.

## Exterior lighting

### Information about lighting systems and your responsibility

The various lighting systems of the vehicle are only aids. The driver of the vehicle is responsible for correct vehicle illumination in accordance with the prevailing light and visibility conditions, legal requirements and traffic situation.

## Light switch

### Operating the light switch

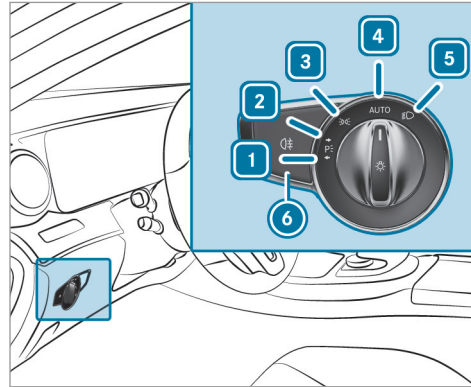

- 1 Left-hand standing lights
- 2 Right-hand standing lights
- 3 Parking lights and license plate lamp
- 4 **AUTO** Automatic driving lights (preferred light switch position)

- 5 Low beam/high beam
- 6 Switches the rear fog light on/off

When low beam is activated, the indicator lamp for the parking lights will be deactivated and replaced by the low-beam indicator lamp.

▶ Always park your vehicle safely using sufficient lighting, in accordance with the relevant legal stipulations.

**!** **NOTE** Battery discharging by operating the standing lights

Operating the standing lights over a period of hours puts a strain on the battery.

▶ Where possible, switch on the right or left parking light.

If the battery is insufficiently charged, the standing lights or parking lights will be switched off automatically to facilitate the next engine start.

## 112 Light and visibility

The exterior lighting (except standing and parking lights) will switch off automatically when the driver's door is opened.

- Observe the notes on surround lighting (→ page 119).

### Automatic driving lights function

When the vehicle is switched on, the parking lamps, low beam and daytime running lamps are switched on automatically depending on the ambient light.

**⚠ WARNING** Risk of accident when the low beam is switched off in poor visibility



When the light switch is set to **AUTO**, the low beam may not be switched on automatically if there is fog, snow or other causes of poor visibility such as spray.

- ▶ In such cases, turn the light switch to .

The automatic driving lights are only an aid. You are responsible for vehicle lighting.

### Switching the rear fog lights on or off

#### Requirements:

- The light switch is in the  or **AUTO** position.
- ▶ Press the  button.

Please observe the country-specific laws on the use of rear fog lamps.

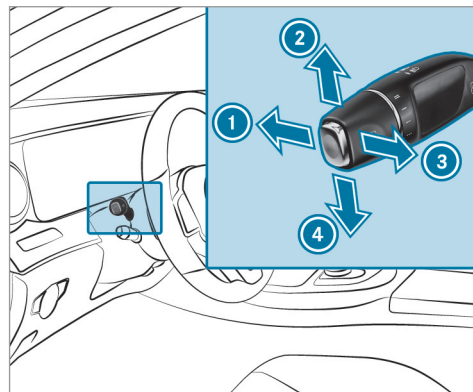

### Operating the combination switch for the lights



- 1 High beam
- 2 Turn signal light, right
- 3 High-beam flasher
- 4 Turn signal light, left

- ▶ Use the combination switch to activate the desired function.

### Switching on high beam

- ▶ Turn the light switch to the  or **AUTO** position.
- ▶ Push the combination switch beyond the point of resistance in the direction of arrow ①. When the high beam is activated, the  indicator lamp for low beam will be deactivated and replaced by the  indicator lamp for high beam.

### Switching off high beam

- ▶ Move the combination switch back to its starting position.

### High-beam flasher

- ▶ Pull the combination switch in the direction of arrow ③.

### Turn signal light

- ▶ **To indicate briefly:** push the combination switch briefly to the point of resistance in the direction of arrow ② or ④. The corresponding turn signal light will flash three times.

▶ **To indicate continuously:** push the combination switch beyond the point of resistance in the direction of arrow ② or ④.

Vehicles with Active Lane Change Assist:

- A turn signal indicator activated by the driver may continue to operate for the duration of the lane change.
- If the driver indicated directly beforehand but a lane change was not immediately possible, the turn signal indicator may activate automatically.

### Activating/deactivating the hazard warning lights

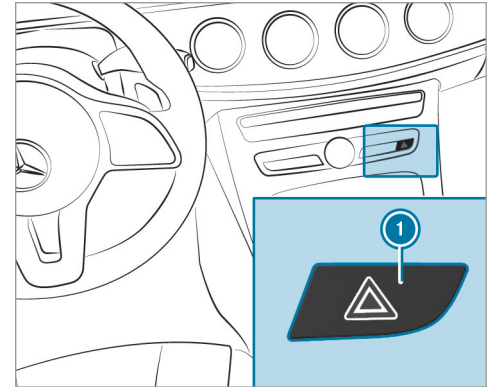

- ▶ Press button ①.

The hazard warning lights will switch on automatically if:

- The airbag has been deployed.

### Adaptive functions, MULTIBEAM LED

#### Intelligent Light System function (Canada)

The MULTIBEAM LED headlamps adapt to the driving and weather situation and provide extended functions for improved illumination of the road.

The system comprises the following functions:

- Active headlamps (→ page 114)
- Cornering light (→ page 114)
- Highway mode (→ page 115)
- Enhanced fog light function (→ page 115)
- Bad weather light (→ page 115)
- City lighting (→ page 115)

The system is active only when it is dark.

#### Active headlamps function

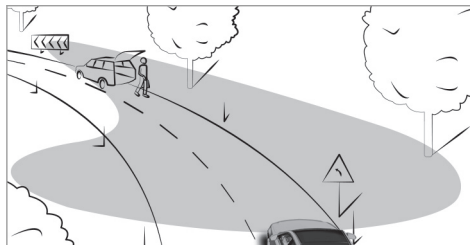

- The headlamps follow the steering movements.
- Relevant areas are better illuminated during a journey.

The functions are active when the low beam is switched on.

Depending on the vehicle's equipment, the course of the lane in which you are driving will also be evaluated and the active headlamps function will adjust the light in advance.

#### Cornering light function

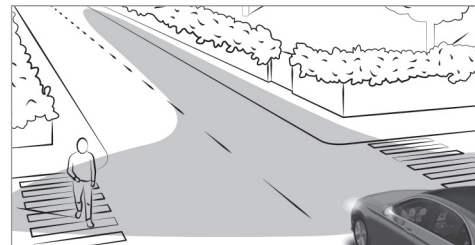

The cornering light improves the illumination of the road over a wide angle in the turning direction, enabling better visibility on tight curves, for example. It can be activated only when the low beam is switched on.

The function is active in the following cases:

- At speeds below 25 mph (40 km/h) when the turn signal light is switched on or the steering wheel is turned
- At speeds between 25 mph (40 km/h) and 43 mph (70 km/h) and when the steering wheel is turned

**Roundabout and intersection function:** the cornering light will be activated on both sides based on an evaluation of the vehicle's current GPS position. It will remain active until after the vehicle has left the roundabout or the intersection.

#### Highway mode function (Canada)

Highway mode increases the range and brightness of the cone of light, enabling better visibility.

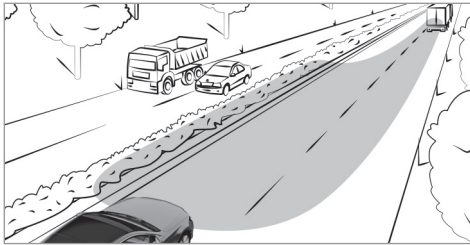

The function will be active if a highway journey is detected by means of:

- The vehicle's speed
- The multifunction camera
- The navigation system

The function is not active in the following cases:

- At speeds below 50 mph (80 km/h)

#### Enhanced fog light function (Canada)

The enhanced fog light function reduces self-blinding and improves the illumination of the edge of the road.

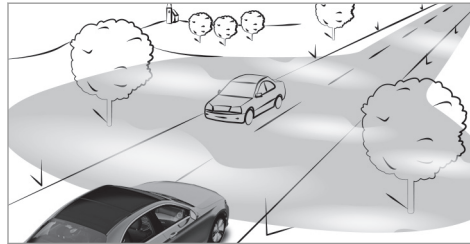

The function is automatically activated under the following conditions:

- At speeds below 43 mph (70 km/h) and when the rear fog light is switched on.

The function is automatically deactivated under the following conditions:

- When speeds greater than 62 mph (100 km/h) are reached.
- When the rear fog light is switched off.

#### Function of the bad weather light (Canada)

The bad weather light reduces reflections in rainy conditions by dimming individual LEDs in the headlamps. The driver and other road users are blinded less as a result.

#### The city lighting function (Canada)

City lighting improves the illumination of roadsides in urban areas using a broad distribution of light.

The function is active in the following cases:

- At low speeds
- In illuminated parts of urban areas

#### Switching the Intelligent Light System on/off (Canada)

##### Requirements:

- The vehicle is switched on.

Multimedia system:

→  ▶▶ Settings ▶▶ Light

▶▶ Intelligent Light System

▶ Switch the function on or off.

### Adaptive Highbeam Assist

#### Adaptive Highbeam Assist function

**⚠ WARNING** Risk of accident despite Adaptive Highbeam Assist

Adaptive Highbeam Assist does not react to:

- Road users without lights, e.g. pedestrians
- Road users with poor lighting, e.g. cyclists
- Road users whose lighting is obstructed, e.g. by a barrier

On very rare occasions, Adaptive Highbeam Assist may fail to recognize other road users with their own lighting, or may recognize them too late.

In these, or in similar situations, the automatic high beam will not be deactivated or will be

activated despite the presence of other road users.

- ▶ Always observe the road and traffic conditions carefully and switch off the high beam in good time.

Adaptive Highbeam Assist cannot take into account road, weather or traffic conditions.

Detection may be restricted in the following cases:

- In poor visibility, e.g. fog, heavy rain or snow
- If there is dirt on the sensors or the sensors are obscured

Adaptive Highbeam Assist is only an aid. You are responsible for adjusting the vehicle's lighting to the prevailing light, visibility and traffic conditions.

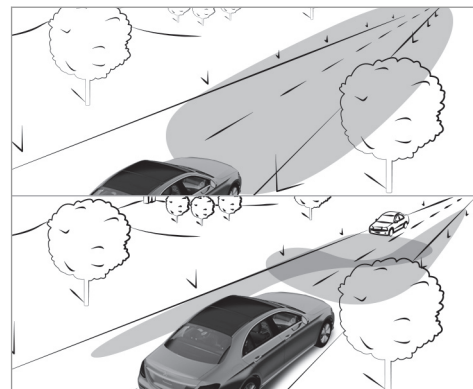

Adaptive Highbeam Assist automatically switches between the following types of light:

- Low beam
- High beam

At speeds greater than 19 mph (30 km/h):

- If no other road users are detected, the high beam will switch on automatically.



The high beam will switch off automatically in the following cases:

- At speeds below 16 mph (25 km/h)
  - If other road users are detected
  - If street lighting is sufficient
- i** The system's optical sensor is located behind the windshield near the overhead control panel.

### Switching Adaptive Highbeam Assist on/off

#### Switching on

- ▶ Turn the light switch to the **AUTO** position.
- ▶ Switch on the high beam using the combination switch.  
If Adaptive Highbeam Assist is activated, the  indicator lamp will light up on the central display section of the instrument display.

#### Switching off

- ▶ Switch off the high beam using the combination switch.

### Adaptive Highbeam Assist Plus

#### Adaptive Highbeam Assist Plus function (Canada)

**⚠ WARNING** Risk of accident despite Adaptive Highbeam Assist Plus

Adaptive Highbeam Assist Plus does not react to:

- Road users without lights, e.g. pedestrians
- Road users with poor lighting, e.g. cyclists
- Road users whose lighting is obstructed, e.g. by a barrier

On very rare occasions, Adaptive Highbeam Assist Plus may fail to recognize other road users with their own lighting, or may recognize them too late.

In these, or in similar situations, the automatic high beam will not be deactivated or will be activated despite the presence of other road users.

- ▶ Always observe the road and traffic conditions carefully and switch off the high beam in good time.

Adaptive Highbeam Assist Plus cannot take into account road, weather or traffic conditions.

Detection may be restricted in the following cases:

- In poor visibility, e.g. fog, heavy rain or snow
- If there is dirt on the sensors or the sensors are obscured

Adaptive Highbeam Assist Plus is only an aid. You are responsible for adjusting the vehicle's lighting to the prevailing light, visibility and traffic conditions.



Adaptive Highbeam Assist Plus automatically switches between the following types of light:

- Low beam
- Partial high beam
- High beam
- ULTRA RANGE Highbeam

ULTRA RANGE Highbeam increases the brightness of the cone of light to the legally permitted maximum.

Partial high beam does not include other road users in the high beam area. It does not blind them but enables full high beam illumination for the driver apart from the excluded vehicles.

At speeds below 16 mph (25 km/h) or when there is sufficient street lighting:

- The partial high beam and the high beam will be switched off automatically.

At speeds greater than 19 mph (30 km/h):

- If no other road users are detected, the high beam will switch on automatically.
- If other road users are detected, the partial high beam will switch on automatically.

At speeds above 25 mph (40 km/h):

- If no other road users are detected on a straight road, ULTRA RANGE Highbeam will be switched on automatically.
- If other road users are detected, the partial high beam will switch on automatically.

- If highly reflective signs are detected, ULTRA RANGE Highbeam will be switched off automatically.

**i** The system's optical sensor is located behind the windshield near the overhead control panel.

### Switching Adaptive Highbeam Assist Plus on/off (Canada)

#### Switching on

- ▶ Turn the light switch to the **AUTO** position.
- ▶ Switch on the high beam using the combination switch. When the high beam is switched on automatically in the dark, the  indicator lamp will light up on the central display section of the instrument display.

#### Switching off

- ▶ Switch off the high beam using the combination switch.

### Switching the daytime running lamps on/off

Multimedia system:

- [Home] » Settings » Light
- » Daytime Run. Lights

- ▶ Switch the function on or off.

### Setting the exterior lighting switch-off delay time

Requirements:

- The light switch is in the **AUTO** position.

Multimedia system:

- [Home] » Settings » Light
- » Exterior Lighting Delay

- ▶ Set the switch-off delay time.

When the vehicle engine is switched off, the exterior lighting will be activated for the set time.

### Switching the surround lighting on/off

Multimedia system:

- [Home] » Settings » Light
- » Locator Lighting

When **Locator Lighting** is active, the exterior lighting lights up for 40 seconds after the vehicle is unlocked. When you start the vehicle, the surround lighting is deactivated and the automatic driving lights are activated.

- ▶ Activate or deactivate the function.

## Interior lighting

### Adjusting the interior lighting

#### Front overhead control panel

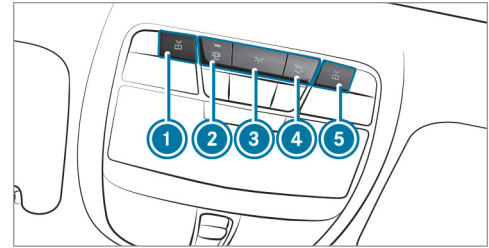

- ① [Icon] Front left reading lamp
- ② [Icon] Automatic interior lighting control
- ③ [Icon] Front interior lighting
- ④ [Icon] Rear interior lighting
- ⑤ [Icon] Front right reading lamp

- ▶ **To switch on/off:** press button ① - ⑤ accordingly.

### Control panel in the grab handle

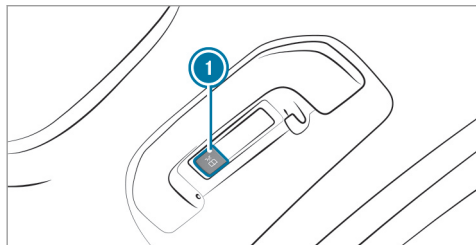

①  Rear reading lamp

▶ To switch on/off: press button ①.

### Adjusting the ambient lighting

Multimedia system:

→  ▶▶ Comfort ▶▶ Ambient Lighting

#### Setting the color

- ▶ Select **Color**.
- ▶ Set the desired color.

#### Adjusting the brightness

- ▶ Select **Brightness**.
- ▶ Adjust the brightness.

#### Activating the brightness for zones

- ▶ Select **Brightness**.
- ▶ Select **Brightness Zones**.
- ▶ Switch the function on or off.

or

- ▶ Set the brightness for the desired zones.

#### Activating multi-color lighting

- ▶ Select **Color**.
- ▶ Select **Multi-color**.
- ▶ Select a color combination.

#### Activating multi-color animation

- ▶ Select **Color**.
- ▶ Select **Multi-color Animation**.  
The chosen color combination will change at predefined intervals.

#### Activating welcome lighting

- ▶ Select **Color**.
- ▶ Select **Welcome**.  
When the vehicle is unlocked, a special ambient lighting sequence will run.

#### Activating dependency on air conditioning settings

- ▶ Select **Color**.
- ▶ Select **Climate**.  
If changes are made to the temperature setting in the vehicle, the color of the ambient lighting will change briefly.

### Switching the interior lighting switch-off delay time on/off

Multimedia system:

→  ▶▶ Settings ▶▶ Light  
▶▶ Interior Lighting Delay



- ▶ Switch the switch-off delay time on or off.  
When this function is active, the interior lighting lights up for a short time after the vehicle is locked.

## Windshield wiper and windshield washer system

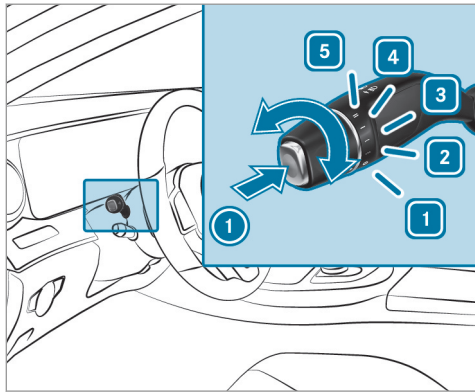
### Switching the windshield wipers on/off



- 1 0 Windshield wipers off
- 2 ... Intermittent wiping, normal
- 3 .... Intermittent wiping, frequent
- 4 — Continuous wiping, slow
- 5 = Continuous wiping, fast

- ▶ Turn the combination switch to the corresponding position 1 - 5.
- ▶ **Single wipe/washing:** push the button on the combination switch in the direction of arrow
  - ① .
  -  Single wipe
  -  Wiping with washer fluid
- ① Observe the notes on washing the vehicle in a car wash (→ page 274).

### Replacing the windshield wiper blades

**⚠ WARNING** Risk of becoming trapped if the windshield wipers are switched on while wiper blades are being replaced

If the windshield wipers begin to move while you are changing the wiper blades, you can be trapped by the wiper arm.

- ▶ Always switch off the windshield wipers and vehicle before changing the wiper blades.

### Moving the wiper arms into the replacement position

- ▶ Switch the vehicle on and then off again immediately.
- ▶ Within around 15 seconds, press and hold the  button on the combination switch for approximately three seconds (→ page 121). The wiper arms will move into the replacement position.

### Removing the wiper blades

- ▶ Fold the wiper arms away from the windshield.

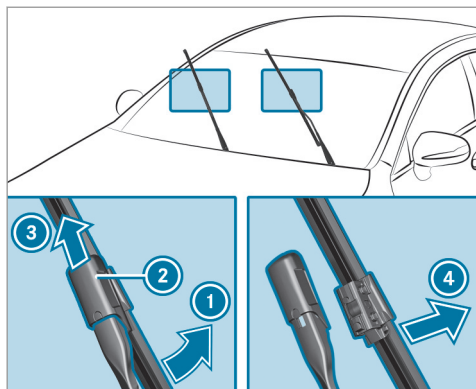

- ▶ Hold the wiper arm with one hand. With the other hand, turn the wiper blade away from the wiper arm in the direction of arrow ① as far as it will go.
- ▶ Slide catch ② in the direction of arrow ③ until it engages in the removal position.
- ▶ Remove the wiper blade from the wiper arm in the direction of arrow ④.

### Installing the wiper blades

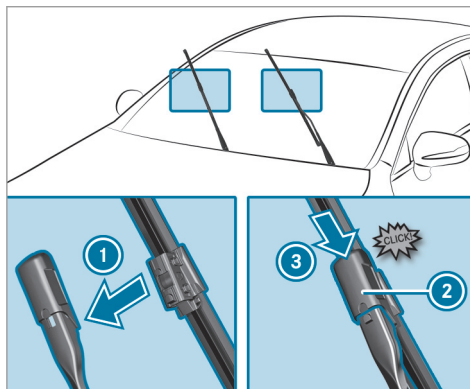

- ▶ Insert the new wiper blade into the wiper arm in the direction of arrow ①.
- ▶ Slide catch ② in the direction of arrow ③ until it engages in the locking position.
- ▶ Make sure that the wiper blade is seated correctly.
- ▶ Fold the wiper arms back onto the windshield.

- ▶ Switch on the vehicle.
  - ▶ Press the  button on the combination switch (→ page 121). The wiper arms will return to their original positions.
  - ▶ Switch off the vehicle.
- ⓘ Check the condition of the wiper blades regularly and replace them in the event of visible damage or ongoing smearing.

### Maintenance display

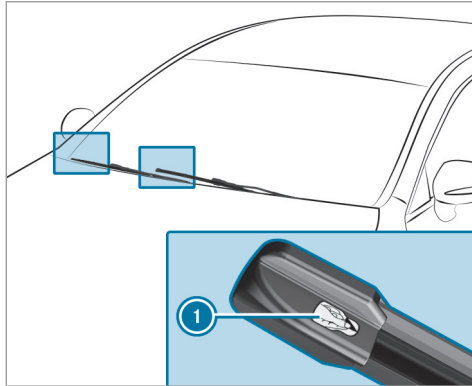

- ▶ Remove protective film ❶ from the maintenance displays on the tips of the newly installed wiper blades.

When the color of the maintenance displays changes from black to yellow, replace the wiper blades.

- ❶ The duration until the color changes varies depending on the usage conditions.

### Mirrors

#### Operating the outside mirrors

- ⚠ **WARNING** Risk of accident due to adjusting the vehicle settings while the vehicle is in motion

You could lose control of the vehicle in the following situations in particular:

- If you adjust the driver's seat, the head restraint, the steering wheel or the mirror while the vehicle is in motion
- If you fasten your seat belt while the vehicle is in motion
- ▶ Before starting the vehicle: in particular, adjust the driver's seat, head restraint, steering wheel and mirror, and fasten your seat belt.

- ⚠ **WARNING** Risk of accident due to misjudgment of distance when using the front-passenger mirror

The outside mirror on the front passenger side reflects objects on a smaller scale. The objects in view are in fact closer than they appear.

- ▶ Therefore, always look over your shoulder to check the actual distance between you and the road users traveling behind you.

### Folding the outside mirrors in/out

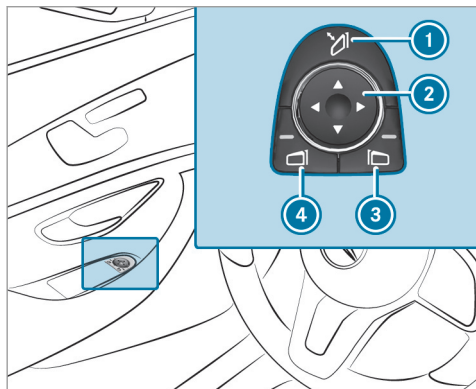

- ▶ Briefly press button ①.

### Resetting the outside mirrors

- ① If the battery has been disconnected or completely discharged, the outside mirrors must be reset. Only then will the automatic mirror folding function work properly.
- ▶ Briefly press button ①.

### Adjusting the outside mirrors

- ▶ Press button ③ or ④ to select the outside mirror to be adjusted.
- ▶ Press button ② to adjust the position of the mirror glass.

### Engaging the outside mirrors

- ▶ Vehicles without electrically folding outside mirrors: manually move the outside mirror into the correct position.
- ▶ Vehicles with electrically folding outside mirrors: press and hold button ①. You will hear a click and the mirror will audibly click into place. The outside mirror will now be set to the correct position.

### Automatic anti-glare mirrors function

**⚠ WARNING** Risk of acid burns and poisoning due to the anti-glare mirror electrolyte

Electrolyte may escape if the glass in an automatic anti-glare mirror breaks.

The electrolyte is hazardous to health and causes irritation. It must not come into contact with your skin, eyes, respiratory organs or clothing or be swallowed.

- ▶ If you come into contact with electrolyte, observe the following:
  - Immediately rinse the electrolyte from your skin with water and seek medical attention.
  - If electrolyte comes into contact with your eyes, immediately rinse them thoroughly with clean water and seek medical attention.
  - If the electrolyte is swallowed, immediately rinse your mouth out thoroughly. Do not induce vomiting. Seek medical attention immediately.
  - Immediately change out of clothing which has been contaminated with electrolyte.
  - If an allergic reaction occurs, seek medical attention immediately.



The inside rearview mirror and the outside mirror on the driver's side will automatically go into anti-glare mode if light from a headlamp hits the sensor on the inside rearview mirror.

### System limits

The system will not go into anti-glare mode if:

- The vehicle is switched off.
- Reverse gear is engaged.
- The interior lighting is switched on.

### Front-passenger outside mirror parking position function

The parking position makes parking easier.

The front-passenger outside mirror will swivel downwards in the direction of the rear wheel on the front passenger's side when:

- The parking position is stored (→ page 125).
- The front-passenger mirror is selected.
- Reverse gear is engaged.

The front-passenger outside mirror will move back to its original position when:

- You shift the transmission to another transmission position.
- You are traveling at a speed greater than 9 mph (15 km/h).
- You press the button for the outside mirror on the driver's side.

### Storing the parking position of the front-passenger outside mirror using reverse gear

#### Storing

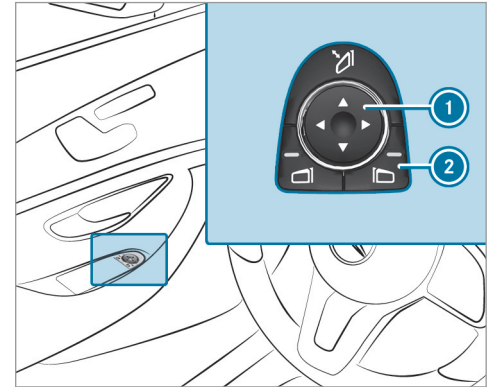

- ▶ Select the front-passenger outside mirror using button ②.
- ▶ Engage reverse gear.
- ▶ Move the front-passenger outside mirror into the desired parking position using button ①.

### Calling up

- ▶ Select the front-passenger outside mirror using button ②.
- ▶ Engage reverse gear.  
The front-passenger outside mirror will move to the stored parking position.

### Activating/deactivating the automatic mirror folding function

Multimedia system:

- ▶  ▶ Settings ▶ Vehicle
- ▶ Switch **Automatic Folding** on or off.

### Area permeable to radio waves on the windshield

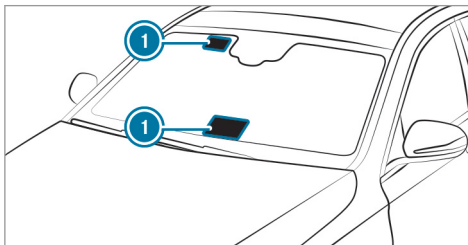

Radio-controlled equipment, such as toll systems, can be mounted only on areas ① of the windshield that are permeable to radio waves.

Areas permeable to radio waves ① are best visible from outside the vehicle when the windshield is illuminated with an external light source.

Note this position for vehicles with:

- Windshield heating
- Infrared reflective windshield

### Infrared-reflective windshield function

The infrared-reflective windshield is coated and reduces the build-up of heat in the vehicle interior. The coating shields the vehicle interior from radio waves.

## Overview of climate control systems

### Notes on climate control

An interior air filter in combination with the prefilter in the engine compartment must always be used so that the air conditioning system, pollution level monitoring and the air filtration work correctly. Use filters recommended and approved by Mercedes-Benz. Always have maintenance work carried out at a qualified specialist workshop.

### Overview of the air conditioning control panel

The indicator lamps on the buttons indicate that the corresponding function is activated.

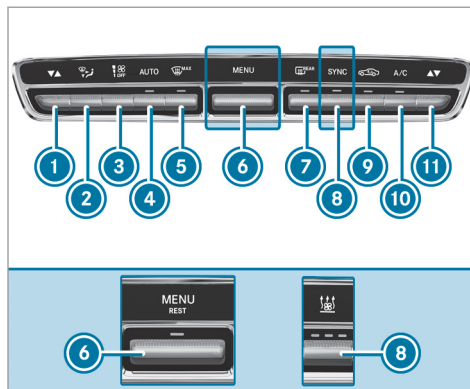

Control panel for dual-zone automatic climate control with/without stationary heater (example)

- ① Sets the temperature, left
- ② Sets the air distribution
- ③ Sets the airflow or switches off climate control
- ④ **AUTO** Sets climate control to automatic mode (→ page 129)
- ⑤ Defrosts the windshield

- ⑥ Vehicles with control panel for dual-zone automatic climate control (without stationary heater): **MENU** calls up the air conditioning menu





Vehicles with control panel for dual-zone automatic climate control (with stationary heater, plug-in hybrid) or control panel for 3-zone automatic climate control (with/without stationary heater, plug-in hybrid): **MENU REST** calls up the air conditioning menu, switches residual heat on/off (→ page 130)

- ⑦ Switches the rear window heater on/off
- ⑧ Vehicles with control panel for dual-zone automatic climate control without stationary heater: **SYNC** switches synchronization on/off (→ page 129)

Vehicles with control panel for 3-zone automatic climate control without stationary heater: **A/C** switches the A/C function on/off (→ page 128)

Vehicles with a stationary heater: switches the stationary heater on/off

Plug-in hybrid: activates/deactivates "Immediate pre-entry climate control"

- ⑨  Switches air-recirculation mode on/off (→ page 130)
- ⑩ Vehicles with control panel for dual-zone automatic climate control:  switches the A/C function on/off (→ page 128)  
Vehicles with control panel for 3-zone automatic climate control:  adjusts the air distribution, right
- ⑪  Sets the temperature, right

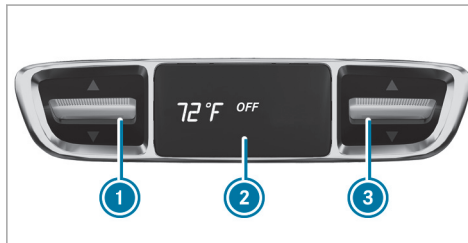

### Rear operating unit in vehicles with control panel for 3-zone automatic climate control



- ① Sets the temperature
- ② Display
- ③ Sets the temperature

### Operating the climate control system

#### Switching climate control on/off

- ▶ **To switch on:** set the airflow to level 1 or higher using the  button.
- ▶ **To switch off:** set the airflow to level 0 using the  button.

If climate control is switched off, the windows may fog up more quickly. Switch climate control off only briefly.

#### Switching the A/C function on/off using the air conditioning control panel

The A/C function heats, cools and dehumidifies the vehicle's interior air.

- ▶ Press the  button.

Switch off the A/C function only briefly; otherwise, the windows may fog up more quickly.

Condensation may drip from the underside of the vehicle when cooling mode is active. This is not indicative of a malfunction.

#### Calling up the air conditioning menu

##### Calling up the air conditioning menu using the multimedia system

- ▶ Select one of the temperature displays at the lower edge of the media display.

### Calling up the air-conditioning menu using the button on the climate control panel

- ▶ Press the  button on the climate control panel.



### Activating/deactivating the A/C function via the multimedia system

The A/C function heats, cools and dehumidifies the vehicle's interior air.

- ▶ Call up the air-conditioning menu (→ page 128).
- ▶ Select **First Row of Seats**.
- ▶ Select **A/C**.

### Setting climate control to automatic mode

In automatic mode, the set temperature is controlled and maintained at a constant level by the air supply.

- ▶ Press the  button.
- ▶ **To switch to manual mode:** press the  or  button.

### Climate style

#### Climate style function

The following climate styles are available in automatic mode:

- **FOCUS:** high airflow, slightly cooler setting
- **MEDIUM:** medium airflow, standard setting
- **DIFFUSE:** low airflow, slightly warmer and draft-free setting

#### Setting the climate style

- ▶ Call up the air conditioning menu (→ page 128).
- ▶ Select **First Row of Seats** or **Second Row of Seats**.
- ▶ Call up the **CLIMATE MODE** menu.
- ▶ Select a climate style.

### Setting the air distribution

- ▶ Call up the air conditioning menu (→ page 128).
- ▶ Select a row of seats.

- ▶ **To set the air distribution:** select ,  or .

- ▶ Set the airflow.

- ⓘ Several air distribution options can be selected at the same time, for example to set the climate control for the windshield and the footwells simultaneously. The  climate control for the windshield can only be selected for the first seat row.

### Activating/deactivating the climate control synchronization function via the air conditioning control panel

Climate control can be set centrally using the synchronization function. The temperature and air distribution settings for the driver's side will be adopted automatically for the front passenger side.

- ▶ Press the  button.

The synchronization function will be deactivated if the settings for one of the other climate control zones are changed.

### Activating/deactivating the climate control synchronization function via the multimedia system

Climate control can be set centrally using the synchronization function. The driver's settings for temperature, air quantity and air distribution are adopted automatically for all climate zones.

- ▶ Call up the air conditioning menu (→ page 128).
- ▶ Select **First Row of Seats**.
- ▶ Select **SYNC**.

### Removing condensation from the windows

#### Windows fogged up on the inside

- ▶ Press the **AUTO** button.
- ▶ If the windows continue to fog up: press the **MAX** button.

#### Windows fogged up on the outside

- ▶ Switch on the windshield wipers.
- ▶ Press the **AUTO** button.

### Switching air-recirculation mode on/off

- ▶ Press the  button.  
The interior air will be recirculated.

Air-recirculation mode automatically switches to fresh air mode after a while.

- ⓘ If air-recirculation mode is switched on, the windows may fog up more quickly. Switch on air-recirculation mode only briefly.

### Switching the residual heat on or off

#### Requirements:

- The vehicle is parked.

It is possible to make use of the residual heat from the engine to continue heating or ventilating the front compartment of the vehicle for approximately 30 minutes.

- ▶ **To switch on:** press the **MENU/RESET** button.

Residual heat is switched off automatically.

### Activating/deactivating ionization

Ionization improves the quality of the vehicle's interior air. Ionization of the interior air is odorless.

- ▶ Call up the air conditioning menu (→ page 128).
- ▶ Select **Air Quality**.
- ▶ Select **IONIZATION**.

### Fragrance system

#### Setting the fragrance system

#### Requirements:

- Automatic climate control is activated.
- The glove box is closed.

The fragrance system distributes a pleasant fragrance throughout the vehicle interior from a flacon located in the glove box.

- ▶ Call up the air conditioning menu (→ page 128).
- ▶ Select **Air Quality**.

- ▶ Select **AIR FRESHENER**.
- ▶ Keep pressing until the desired intensity is reached.

### Inserting or removing the flacon of the fragrance system

**⚠ WARNING** Risk of injury from liquid perfume

If children open the flacon, they could drink the liquid perfume or it could come into contact with their eyes.

- ▶ Do not leave children unattended in the vehicle.
- ▶ Consult a doctor immediately if liquid perfume has been drunk.
- ▶ If liquid perfume comes into contact with your eyes or skin, rinse your eyes with clean water.
- ▶ If symptoms continue, consult a doctor.

**🔥 ENVIRONMENTAL NOTE** Environmental damage due to improper disposal of full flacons



Full flacons must not be disposed of with household waste.



Full flacons must be taken to a harmful substance collection point.

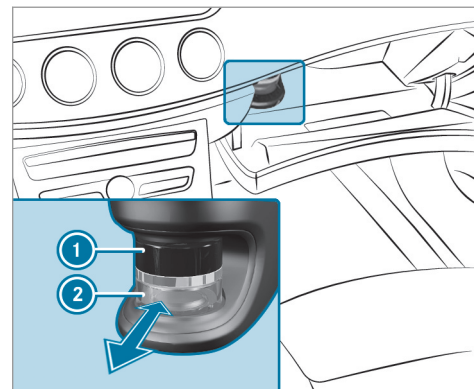

- ① Cap
- ② Flacon

- ▶ **To insert:** slide the flacon into the holder as far as it will go.
- ▶ **To remove:** pull out the flacon.

If you do not use genuine Mercedes-Benz interior perfumes, observe the manufacturers' safety notices on the perfume packaging.

Dispose of the genuine Mercedes-Benz interior perfume flacon when it is empty and do not refill it.

### Refillable flacon

- ▶ Unscrew the cap of the empty flacon.
- ▶ Fill the flacon with a maximum of 0.5 fl. oz. (15 ml).
- ▶ Screw the cap back on to the flacon.

Always refill the empty refillable flacon with the same perfume. Observe the separate information sheet with the flacon.

### Information on the windshield heater

The windshield heater is switched on automatically if the  button is activated.

After the vehicle is started, the windshield heater will be switched on automatically as required.

### Air vents

#### Adjusting the front air vents

**⚠ WARNING** Risk of burns or frostbite due to being too close to the air vents

Very hot or very cold air can flow from the air vents.

- ▶ Make sure that all vehicle occupants always maintain a sufficient distance from the air vents.
- ▶ If necessary, direct the airflow to another area of the vehicle interior.

To guarantee the flow of fresh air through the air vents into the vehicle interior, comply with the following:

- Always keep the vents and ventilation grilles in the vehicle interior clear.
- Keep the air inlet free of deposits (→ page 274).

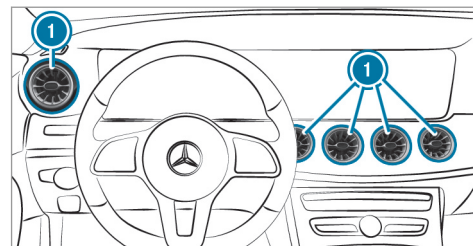

▶ **To open or close:** hold air vent ① in the center and turn it to the left or right as far as it will go.

▶ **To set the airflow direction:** hold air vent ① in the center and move it up or down or to the left or right.



### Adjusting the rear air vents

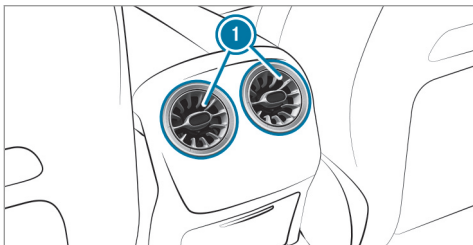

- ▶ **To open or close:** hold air vent ① in the center and turn it to the left or right as far as it will go.
- ▶ **To set the airflow direction:** hold air vent ① in the center and move it up or down or to the left or right.

## Driving

### Notes on Mercedes-AMG vehicles

Observe the notes on the following topics in the Supplement, otherwise you may fail to recognize dangers.

- ① The availability of certain functions depends on the equipment and model of the vehicle.
- Emotion Start
- AMG performance exhaust system
- AMG ceramic high-performance composite brake system
- DRIFT MODE
- AMG adaptive sport suspension system +
- AMG steering-wheel buttons

### Switching on the power supply or the vehicle

**⚠ WARNING** Risk of accident and injury due to children left unattended in the vehicle

If children are left unsupervised in the vehicle, they could, in particular:

- open doors, thereby endangering other persons or road users.
- get out and be struck by oncoming traffic.
- operate vehicle equipment and become trapped, for example.

In addition, the children could also set the vehicle in motion, for example by:

- releasing the parking brake.
- changing the transmission position.
- starting the vehicle.

▶ Never leave children unattended in the vehicle.

▶ When leaving the vehicle, always take the SmartKey with you and lock the vehicle.

▶ Keep the vehicle SmartKey out of reach of children.

#### Requirements:

- The SmartKey is in the vehicle and is recognized.
- The brake pedal is not depressed.

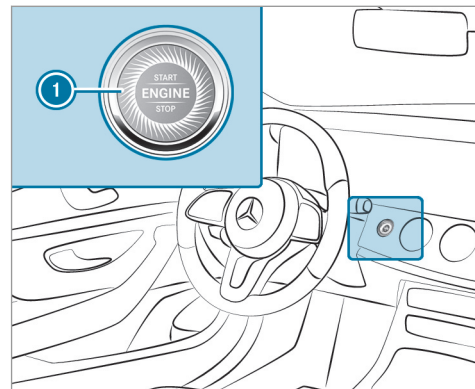

- ▶ **To switch on the power supply:** press button  once.  
You can, for example, activate the windshield wipers.

The power supply is switched off again if the following conditions are met:

- You open the driver's door.
- You press button  twice more.

- ▶ **To switch on the vehicle:** press button  twice.  
Indicator and warning lamps go on in the instrument cluster.

The vehicle is switched off again if one of the following conditions is met:

- You do not start the vehicle within 15 minutes and the transmission is in position **P** or the electric parking brake is applied.
- You press button  once.

## Starting the vehicle

### Starting the vehicle with the start/stop button

**⚠ DANGER** Risk of fatal injuries caused by exhaust gases

Combustion engines emit poisonous exhaust gases, such as carbon monoxide. Inhaling these exhaust gases is hazardous to health and leads to poisoning.





- ▶ Never run the vehicle and, if present, the stationary heater indoors without sufficient ventilation.

**⚠ WARNING** Risk of fire due to flammable material in the engine compartment or the exhaust system

Flammable materials may ignite.

- ▶ Therefore, check regularly that there are no flammable materials in the engine compartment or on the exhaust system.

### Requirements:

- The SmartKey is in the vehicle and is recognized.
- ▶ Shift the transmission to position **P** or **N**.
  - ▶ Depress the brake pedal and press button  once.
  - ▶ If the vehicle does not start: switch off non-essential consumers and press button  once.
  - ▶ If the vehicle still does not start and the display message **Place the Key in the Marked Space** See [Operator's Manual](#) appears in the instrument display: start the vehicle with the SmartKey in the marked space (emergency operation mode) (→ page 136).
-  You can switch off the vehicle while driving. To do this, press button  for about three seconds or by pressing button  three times within three seconds. Be sure to observe the safety notes under "Driving tips" (→ page 139).

Observe any information regarding display messages that can be displayed on the instrument display.

### Starting the vehicle with the SmartKey in the marked space (emergency operation mode)

If the vehicle does not start and the [Place the Key in the Marked Space](#) See Operator's Manual message appears in the instrument display, you can start the vehicle in emergency operation mode.

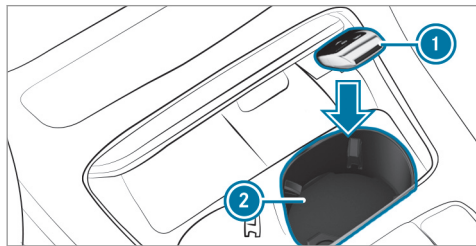

- ▶ Make sure that marked space ② is empty.
- ▶ Remove SmartKey ① from the key ring.

- ▶ Place SmartKey ① in marked space ②. The vehicle will start after a short time.

When you remove SmartKey ① from marked space ②, the vehicle can be driven. For further engine starts however, SmartKey ① must be located in marked space ② during the entire journey.

- ▶ Have SmartKey ① checked at a qualified specialist workshop.

### If the vehicle does not start:

- ▶ Place SmartKey ① in marked space ② and leave it there.
- ▶ Depress the brake pedal and start the vehicle using the start/stop button.

**i** You can switch on the power supply or the vehicle with the start/stop button.

Observe any information regarding display messages that can be displayed on the instrument display.

## Starting the vehicle via Remote Online Services

### Cooling or heating the vehicle interior before starting the journey

Ensure the following before starting the engine:

- The legal stipulations in the area where your vehicle is parked allow engine starting via smartphone.
- It is safe to start and run the engine where your vehicle is parked.
- The fuel tank is sufficiently full.
- The starter battery is sufficiently charged.

### Charging the starter battery before starting the journey

You can receive a message on your smartphone when the state of charge of the starter battery is low. You can then start the vehicle with the smartphone to charge the battery. The vehicle is automatically switched off after ten minutes.

Ensure the following before starting the vehicle:

- The legal stipulations in the area where your vehicle is parked allow engine starting via smartphone.

- It is safe to start and run the engine where your vehicle is parked.
- The fuel tank is sufficiently full.

### Starting the vehicle (Remote Online)

**⚠ WARNING** Risk of crushing or entrapment due to unintentional starting of the engine

Limbs could be crushed or trapped if the engine is started unintentionally during service or maintenance work.

- ▶ Always secure the engine against unintentional starting before carrying out maintenance or repair work.



#### Requirements:

- Park position **P** is selected.
- The anti-theft alarm system is not activated.
- The panic alarm is not activated.
- The hazard warning light system is switched off.
- The hood is closed.
- The doors are closed and locked.
- The windows and sliding sunroof are closed.

- ▶ Start the vehicle using the smartphone. After every engine start, the engine runs for ten minutes.

You can carry out a maximum of two consecutive starting attempts. You must start the engine with the SmartKey before trying to start the vehicle again with the smartphone.

You can switch off the vehicle at any time as follows:

- Via the smartphone app
- By pressing the  or  button on the SmartKey

- ⓘ Further information can be found in the smartphone app.

#### Securing the vehicle against starting before carrying out maintenance or repair work:

- ▶ Switch on the hazard warning light system.  
or
- ▶ Unlock the doors.  
or

- ▶ Open a side window or the sliding sunroof.

#### Breaking-in notes

To preserve the engine during the first 1,000 miles (1,500 km):

- Drive at varying road speeds and engine speeds.
- Do not drive at speeds greater than 85 mph (140 km/h).
- Drive the vehicle in drive program **C** or **E**.
- Shift to the next highest gear at the very latest when the needle reaches the last third before the red area in the tachometer.
- Do not shift down manually in order to brake.
- Avoid overstraining the vehicle, e.g. driving at full throttle.
- Do not depress the accelerator pedal past the pressure point (kickdown).
- Only increase the engine speed gradually and accelerate the vehicle to full speed after 1,000 miles (1,500 km).

This also applies when the engine or parts of the drivetrain have been replaced.

Please also observe the following breaking-in notes:

- In certain driving and driving safety systems, the sensors adjust automatically while a certain distance is being driven after the vehicle has been delivered or after repairs. Full system effectiveness is not reached until the end of this teach-in process.
- Brakepads, brake discs and tires that are either new or have been replaced only achieve optimum braking effect and grip after several hundred kilometers of driving. Compensate for the reduced braking effect by applying greater force to the brake pedal.

### Notes on optimized acceleration

If all necessary requirements and activation conditions are fulfilled, the best possible acceleration can be achieved from a standstill.

Do not use the optimized acceleration on public roads. Individual wheels could spin and you could

lose control of the vehicle. There is an increased risk of skidding and/or accident.

Be sure to observe the safety notes and information on ESP® (→ page 165).

### Pulling away with optimized acceleration

**⚠ WARNING** Risk of skidding and having an accident from wheels spinning

When you use optimized acceleration, individual wheels could spin and you could lose control of the vehicle.

If ESP® is deactivated, there is a risk of skidding and accident.

- ▶ Make sure that no persons or obstacles are in the close vicinity of your vehicle.

### Requirements:

- The vehicle has been broken in (→ page 137).
- The vehicle and tires are in good condition.
- You are on a high-grip roadway.
- The engine and transmission are at normal operating temperature.

**! NOTE** Increased wear due to optimized acceleration

When pulling away with optimized acceleration, all components of the drivetrain are subjected to a very high load.

This can lead to increased component wear.

- ▶ Do not always pull away with optimized acceleration.

- ▶ Engage the **D** drive position (→ page 150).
- ▶ Move the steering wheel to the straight-ahead position.
- ▶ Select the sportiest available drive program **S** or **S** (→ page 147).
- ▶ Deactivate ESP® (→ page 166).
- ▶ Depress and hold the brake pedal firmly with your left foot.
- ▶ With your right foot, fully depress the accelerator pedal.

- ▶ After no more than five seconds, take your left foot quickly off the brake, but keep the accelerator pedal depressed. The vehicle pulls away at maximum acceleration.
- ▶ Switch on ESP® once the acceleration procedure is complete.

#### Ending optimized acceleration

- ▶ Remove your foot from the accelerator pedal.
  - ▶ Reactivate the ESP®.
- ⓘ After you pull away with optimized acceleration, components of the drivetrain can become very hot, which means that optimized acceleration values may be reached again only after a few minutes.

#### Notes on driving

**⚠ WARNING** Risk of accident due to objects in the driver's footwell

Objects in the driver's footwell may impede pedal travel or block a depressed pedal.

This jeopardizes the operating and road safety of the vehicle.

- ▶ Stow all objects in the vehicle securely so that they cannot get into the driver's footwell.
- ▶ Always install the floor mats securely and as prescribed in order to ensure that there is always sufficient room for the pedals.
- ▶ Do not use loose floor mats and do not place floor mats on top of one another.

**⚠ WARNING** Risk of accident due to incorrect footwear

Incorrect footwear includes, for example:

- Shoes with platform soles
- Shoes with high heels
- Slippers

There is a risk of an accident.

- ▶ Always wear suitable footwear so that you can operate the pedals safely.

**⚠ WARNING** Risk of accident if the vehicle is switched off while driving

If you switch off the vehicle while driving, safety functions are restricted or no longer available.

This may affect the power steering system and the brake force boosting, for example.

You will need to use considerably more force to steer and brake, for example.

- ▶ Do not switch off the vehicle while driving.

**⚠ DANGER** Risk of fatal injuries caused by exhaust gases

Combustion engines emit poisonous exhaust gases, such as carbon monoxide. Inhaling these exhaust gases is hazardous to health and leads to poisoning.

- ▶ Never run the vehicle and, if present, the stationary heater indoors without sufficient ventilation.

**⚠ WARNING** Risk of skidding and of an accident due to shifting down on slippery road surfaces

If you shift down on slippery road surfaces to increase the engine braking effect, the drive wheels may lose traction.

- ▶ Do not shift down on slippery road surfaces to increase the engine braking effect.

**⚠ DANGER** Risk of fatal injury due to poisonous exhaust gases

If the tailpipe is blocked or sufficient ventilation is not possible, poisonous exhaust gases such as carbon monoxide may enter the vehicle. This is the case, for example, if the vehicle gets stuck in the snow.

- ▶ Keep the tailpipe and the area around the vehicle free from snow when the vehicle or the stationary heater is running.

- ▶ Open a window on the side of the vehicle facing away from the wind to ensure an adequate supply of fresh air.

**⚠ WARNING** Risk of accident and injury due to being under the influence of alcohol and drugs while driving

Drinking and driving and/or taking drugs and driving are very dangerous combinations. Even a small amount of alcohol or drugs can affect your reflexes, perceptions and judgment.

The possibility of a serious or even fatal accident are greatly increased when you drink or take drugs and drive.

- ▶ Do not drink or take drugs and drive or allow anyone to drive who has been drinking or taking drugs.

**⚠ WARNING** Risk of accident due to the brake system overheating

If you leave your foot on the brake pedal when driving, the brake system may overheat.

This increases the braking distance and the brake system can even fail.

- ▶ Never use the brake pedal as a footrest.
- ▶ Do not depress the brake pedal and the accelerator pedal at the same time while driving.

**! NOTE** Engine damage due to excessively high engine speeds

The engine will be damaged if you drive with the engine in the overrevving range.

- ▶ Do not drive with the engine in the overrevving range.

**! NOTE** Wearing out the brake linings by continuously depressing the brake pedal

- ▶ Do not depress the brake pedal continuously whilst driving.
- ▶ To use the braking effect of the engine, shift to a lower gear in good time.



**!** **NOTE** Damage to the drivetrain and engine when pulling away

- ▶ Do not warm up the engine while the vehicle is stationary. Pull away immediately.
- ▶ Avoid high engine speeds and driving at full throttle until the engine has reached its operating temperature.

**!** **NOTE** Damage to the catalytic converter due to non-combusted fuel

The engine is not running smoothly and is misfiring.

Non-combusted fuel may get into the catalytic converter.

- ▶ Only depress the accelerator pedal slightly.
- ▶ Have the cause rectified immediately at a qualified specialist workshop.

**!** **NOTE** Reduced battery life due to frequent short-distance trips

The 12 V battery may not be sufficiently charged when the vehicle is used only for short-distance trips. This reduces the life of the battery.

- ▶ Drive longer distances regularly to charge the battery.

**!** **NOTE** Damage to the vehicle due to not observing the maximum permitted headroom clearance

If the vehicle height is greater than the maximum permitted headroom clearance, the roof and other parts of the vehicle may be damaged.

- ▶ Observe the signposted headroom clearance.
- ▶ If the vehicle height is greater than the permitted headroom clearance, do not enter.

- ▶ Observe the changed vehicle height with add-on roof equipment.

### Notes on driving with a roof load, trailer or fully laden vehicle

When driving with a loaded roof luggage rack or trailer as well as with a fully laden or fully occupied vehicle, the vehicle's driving and steering characteristics change.

You should bear the following in mind:

- Do not exceed the permissible roof load and towing capacity. Also observe the technical data in the printed Operator's Manual.
- Evenly distribute the roof load, and place heavy objects at the bottom. Also comply with the notes on loading the vehicle (→ page 97).
- Drive attentively, and avoid suddenly pulling away, braking and steering as well as rapid cornering.

### Notes on driving on salt-treated roads

The braking effect is limited on salt-treated roads.

Therefore, observe the following notes:

- Due to salt build-up on the brake discs and brakepads, the braking distance can increase considerably or result in braking only on one side
- Maintain a much greater safe distance to the vehicle in front

To remove salt build-up:

- Brake occasionally while paying attention to the traffic conditions
- Carefully depress the brake pedal at the end of the journey and when starting the next journey

### Notes on hydroplaning

Hydroplaning can take place once a certain amount of water has accumulated on the road surface.

Observe the following notes during heavy precipitation or in conditions in which hydroplaning may occur:

- Reduce speed
- Avoid tire ruts

- Avoid sudden steering movements
- Brake carefully

**i** Also observe the notes on regularly checking wheels and tires (→ page 301).

### Notes on driving through water on the road surface

Water which has entered into the vehicle can damage the engine, electrics and transmission.

Water can also enter the air intake of the engine and cause engine damage.

Observe the following if you must drive through water:

- The water, when calm, may only reach the lower edge of the vehicle body.
- Drive at a maximum speed of 6 mph (10 km/h); water can otherwise enter the vehicle interior or engine compartment.
- Vehicles traveling in front, or oncoming vehicles, can create waves which may exceed the maximum permissible depth of the water.

The braking effect of the brakes is reduced after fording. Brake carefully while paying attention to

the traffic conditions until braking power has been fully restored.

### ECO start/stop function

---

#### ECO start/stop function

**i** Depending on the engine, the ECO start/stop function is not available in all drive programs. Observe the status display in the instrument display for this.

The engine is switched off automatically in the following situations if all vehicle conditions for an automatic engine stop are met:

- You brake the vehicle to a standstill in transmission position **D** or **N**.
- **Vehicles with a 48 V on-board electrical system:** you depress the brake pedal when traveling at a low speed.

If the system has detected one of the following situations, the engine will not stop:

- You stop at a stop sign and there is no vehicle in front of you.

- The vehicle that stopped in front of you starts up again.
- You maneuver, turn the steering wheel sharply or engage reverse gear.





**i** If the system detects an intelligent stop inhibitor, for example, a stop sign, the engine will not stop.  
If you activate the HOLD function or engage the park position **P**, the engine can be switched off in spite of an intelligent stop inhibitor.

The engine restarts automatically in the following cases:

- You engage transmission position **D** or **R**.
- You depress the accelerator pedal.
- An automatic vehicle engine start is required.
- You release the brake pedal.
- **Vehicles with a 48 V on-board electrical system:**
  - You release the brake pedal on a downhill gradient and the vehicle does not roll.

- The vehicle rolls on a downhill gradient and does not automatically enter glide mode at 15 mph (20 km/h).

ECO start/stop function symbols in the instrument display:

- The  symbol (green) appears when the vehicle is at a standstill: the engine was switched off by the ECO start/stop function.
- The  symbol (yellow) appears when the vehicle is at a standstill: not all vehicle conditions for an engine stop have been met.
- Neither the  nor  symbol appears when the vehicle is at a standstill: an intelligent stop inhibitor was detected, e.g. a stop sign.
- The  symbol appears: the ECO start/stop function is deactivated or there is a malfunction.

If the engine was switched off by the ECO start/stop function and you leave the vehicle, a warning tone sounds and the engine is not restarted. In addition, the following display message appears in the instrument display:

### Vehicle Ready to Drive Switch the Ignition Off Before Exiting

If you do not switch off the vehicle, it is automatically switched off after three minutes.

### Deactivating or activating the ECO start/stop function

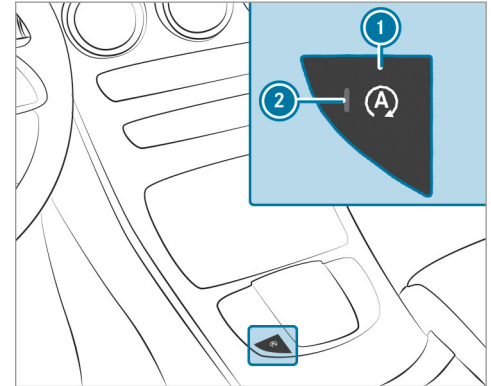

▶ Press button ①.  
If indicator lamp ② lights up, the ECO start/  
stop function is activated.

① Depending on the model and the vehicle  
equipment, the button may also be located at  
a different position in the center console.

### ECO display function

The ECO display summarizes your driving characteristics from the start of the journey to its completion and assists you in achieving the most economical driving style.

You can influence consumption by doing the following:

- Driving with particular care.
- Following the gearshift recommendations.

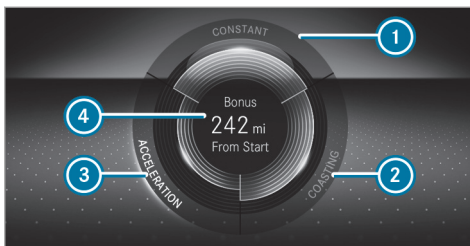

The lettering in the segment will light up brightly, the outer edge will light up and the segment will fill up when the following driving style is adopted:

- ① Steady speed
- ② Gentle deceleration and rolling
- ③ Moderate acceleration

The lettering in the segment will be gray, the outer edge will be dark and the segment will empty when the following driving style is adopted:

- ① Fluctuations in speed
- ② Heavy braking
- ③ Sporty acceleration

The ECO display will show you when you have driven economically:

- The three segments will fill up completely at the same time
- The edges around all three segments will light up

The additional range achieved as a result of your driving style in comparison with a driver with a very sporty driving style will be shown on the center of display ④. The range displayed does not indicate a fixed reduction in consumption.

### ECO Assist function (vehicles with 48 V on-board electrical system)

ECO Assist analyzes data for the vehicle's expected route. This allows the system to optimally adjust the driving style for the route ahead, save fuel and recuperate.

ECO Assist is displayed on the Assistance menu(→ page 218).

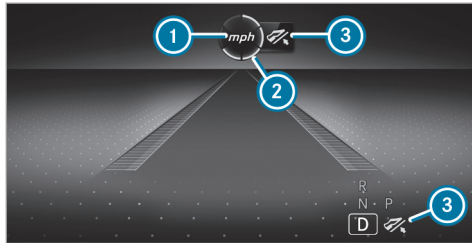

- ① Event ahead
- ② Distance display for the event ahead
- ③ "Foot off the accelerator" prompt

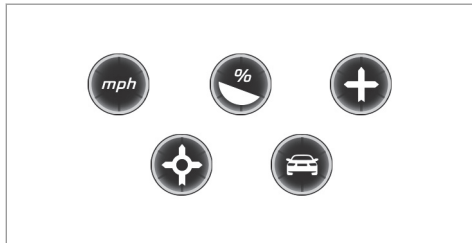

Displayable route events ①

The segments of distance display ② show the distance to the event ahead as follows:

- A few segments light up: the event ahead is near.
- Many segments light up: the event ahead is further away.

When the vehicle nears the event, ECO Assist will calculate the optimal speed for maximum fuel economy and recuperative energy based on the distance, speed and gradient. The **Foot off the Accelerator** message ③ appears in the Instrument Display. The first segments in front of the vehicle will turn green. The remaining segments will initially stay white. If you take your foot off the accelerator pedal in good time, the remaining segments on the display will successively turn green until the event shown is reached. The drivetrain will be set for maximum fuel economy. Recuperation will charge the battery. Recuperation will be adapted to the selected drive program.

The event will be shown for a short time after it has been passed. If there is no response to the **Foot off the Accelerator** prompt, the segments will remain white.

If the event involves a vehicle in front, all segments will immediately turn green once there is a response to the **Foot off the Accelerator** prompt. For active ECO Assist in drive program [E], symbol ③ will appear on the instrument display and on the head-up display beside transmission position [D]. Symbol ③ will also appear when the assistant display is not selected.

If the system does not intervene during the event ahead, nothing will be displayed. The system will be passive.

ECO Assist is active only in drive programs [E] and [C].

#### System limits

ECO Assist can function even more precisely if the route is adhered to when route guidance is active. The basic function is also available without active route guidance. Not all information and traffic situations can be foreseen. The quality depends on the map data.

ECO Assist is only an aid. The driver is responsible for keeping a safe distance from the vehicle in front, for vehicle speed and for braking in good time. The driver must be ready to brake at all

times irrespective of whether the system intervenes.

The system may be impaired or may not function in the following situations:

- If visibility is poor, e.g. due to insufficient illumination of the road, highly variable shade conditions, rain, snow, fog or heavy spray.
- If there is glare, e.g. from oncoming traffic, direct sunlight or reflections.
- If there is dirt on the windshield in the area of the multifunction camera or the camera is fogged up, damaged or obscured.
- If road signs are hard to detect, e.g. due to dirt, snow or insufficient lighting, or because they are obscured.
- If the information on the navigation system's digital map is incorrect or out of date.
- If signs are ambiguous, e.g. road signs in roadworks or in adjacent lanes.

### DYNAMIC SELECT switch

#### Function of the DYNAMIC SELECT switch

##### **!** NOTE Mercedes-AMG vehicles

▶ Observe the notes in the Supplement. You could otherwise fail to recognize dangers.

**i** Depending on the engine and equipment, the vehicle has different drive programs.

Use the DYNAMIC SELECT switch to change between the following drive programs.

The drive program selected appears in the multifunction display of the on-board computer.

##### **I** Individual

- Individual settings

##### **S** Sport+

- Particularly sporty driving
- Emphasizes the vehicle's own oversteering and understeering characteristics for a more active driving style

- Only suitable for good road conditions, a dry road surface and a clear stretch of road

##### **S** Sport

- Continues to offer stability but with a sporty setup
- Allows the sporty driver a more active driving style
- Only suitable for good road conditions, a dry road surface and a clear stretch of road

##### **C** Comfort

- Comfortable and economical driving
- Balance between traction and stability
- Recommended for all road conditions

##### **E** Eco

- Particularly economical driving
- Balance between traction and stability
- Recommended for all road conditions

- ⓘ The ESP® settings in the drive programs **E** and **C** are designed for stability. Therefore, choose one of these driving programs, especially when transporting roof loads, in trailer operation and when the vehicle is fully loaded or fully occupied.

Depending on the drive program, the following systems change their characteristics:

- Drive
  - Engine and transmission management
  - Active Distance Assist DISTRONIC
- ESP®
- **Vehicles with AIR BODY CONTROL or DYNAMIC BODY CONTROL:** suspension
- Electric power steering

### Selecting the drive program

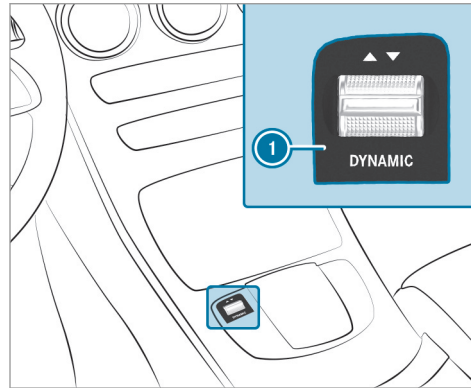

- ▶ Press DYNAMIC SELECT switch ① forwards or backwards. The drive program selected appears in the instrument display.

### Configuring DYNAMIC SELECT (multimedia system)

Multimedia system:

- ▶ ▶ Settings ▶ Vehicle
- ▶ DYNAMIC SELECT

#### Setting drive program I

- ▶ Select **Individual Configuration**.
- ▶ Select and set a category.

#### Switching the restoration display on or off

- ▶ Switch **Request at Start** on or off.

**Function on:** the next time the vehicle is started a prompt appears asking whether the last active drive program should be restored. If the ECO start/stop function was deactivated, an additional prompt appears asking if the function should remain deactivated.

- ⓘ The prompt appears only if the previously active settings deviate from the standard settings.

**Function off:** the next time the vehicle is started the **C** drive program is set automatically. The

ECO start/stop function is activated automatically.

- ⓘ This function must be activated for each user profile separately. Only when this function is activated will the drive program and Eco start/stop setting for the previous journey be saved for the respective user profile.

### Displaying vehicle data

Multimedia system:



- ▶ Select **Vehicle**.  
The vehicle data is displayed.

### Displaying engine data

Multimedia system:



- ▶ Select **Engine**.  
The engine data is displayed.
- ⓘ The actual (maximum) values that can be achieved for engine output and engine torque may deviate from the certified values within

the country-specific guidelines for permissible tolerances (basis: UN-ECE No. 85 or country-specific guidelines).

Influencing variables that can influence this are, for example:

- Sea level
- Fuel quality
- Outside temperature
- Operating temperature of the engine

- ⓘ The values displayed serve only as orientation. The values for engine output and engine torque shown on the media display may deviate from the actual values.

### Calling up the fuel consumption indicator

Multimedia system:



- ▶ Select **Consumption**.  
The current and average fuel consumption is displayed.

## Automatic transmission

### DIRECT SELECT lever

#### Function of the DIRECT SELECT lever

**⚠ WARNING** Risk of accident due to incorrect gearshifting

If the engine speed is higher than the idle speed and you engage the transmission position **D** or **R**, the vehicle may accelerate sharply.

- ▶ If you engage the transmission position **D** or **R** when the vehicle is at a standstill, always depress the brake pedal firmly and do not accelerate at the same time.



**⚠ WARNING** Risk of accident and injury due to children left unattended in the vehicle

If children are left unsupervised in the vehicle, they could, in particular:

- open doors, thereby endangering other persons or road users.
- get out and be struck by oncoming traffic.
- operate vehicle equipment and become trapped, for example.

In addition, the children could also set the vehicle in motion, for example by:

- releasing the parking brake.
  - changing the transmission position.
  - starting the vehicle.
- ▶ Never leave children unattended in the vehicle.
- ▶ When leaving the vehicle, always take the SmartKey with you and lock the vehicle.
- ▶ Keep the vehicle SmartKey out of reach of children.

Use the DIRECT SELECT lever to switch the transmission position. The current transmission position is displayed in the instrument display.

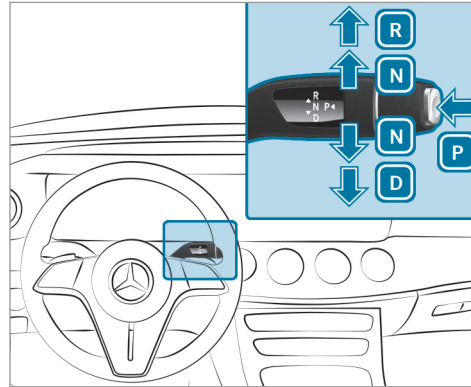

- P** Park position  
**R** Reverse gear  
**N** Neutral  
**D** Drive position

### Engaging reverse gear R

- ▶ Depress the brake pedal and push the DIRECT SELECT lever upwards past the first point of resistance.

### Engaging neutral N

- ▶ Depress the brake pedal and push the DIRECT SELECT lever up or down to the first point of resistance.

- i** To shift into neutral **N** with the vehicle switched on, push the selector lever up or down for several seconds to the first point of resistance.

Subsequently releasing the brake pedal will allow you to move the vehicle freely, e.g. to push it or tow it away.

### Proceed as follows if you want the automatic transmission to remain in neutral **N** even if the vehicle is switched off or the driver's door is opened:

- ▶ Depress the brake pedal and engage neutral **N** when the vehicle is stationary.
- ▶ Release the brake pedal.
- ▶ Switch off the vehicle.

- ❗ If you then exit the vehicle leaving the Smart-Key in the vehicle, the automatic transmission remains in neutral **N**.

### Engaging park position P

- ▶ Observe the notes on parking the vehicle (→ page 155).
- ▶ Depress the brake pedal until the vehicle comes to a standstill.
- ▶ When the vehicle is at a standstill, press button **P**.  
When the transmission position display shows **P**, the park position is engaged. If no transmission position display **P** appears, secure the vehicle to prevent it from rolling away.
- ❗ Depending on the situation, it may take a short time until **P** is engaged. Therefore, always pay attention to the transmission position display.

Park position **P** is engaged automatically if one of the following conditions is met:

- You switch the stationary vehicle off in transmission position **D** or **R**.

- You open the driver's door when the vehicle is at a standstill or when driving at a very low speed and the transmission position is **D** or **R**.

- ❗ To maneuver with an open driver's door, open the driver's door while at a standstill and engage transmission position **D** or **R** again.

### Engaging drive position D

- ▶ Depress the brake pedal and push the DIRECT SELECT lever down past the first point of resistance.

When the automatic transmission is in transmission position **D**, it shifts the gears automatically. This depends, among other things, on the following factors:

- The selected drive program
- The position of the accelerator pedal
- The driving speed

### Problems with the transmission

#### The transmission has a faulty gear shift

Possible cause:

- The transmission is losing oil.
- ▶ Have the transmission checked at a qualified specialist workshop immediately.

#### The acceleration characteristics get worse, and the transmission no longer shifts.

Possible cause:

- The transmission is in emergency operation mode: it is only possible to shift to one gear and reverse gear.
- ▶ Stop the vehicle in accordance with the traffic conditions.
  - ▶ Shift the transmission to position **P**.
  - ▶ Switch off the vehicle.
  - ▶ Wait at least ten seconds.
  - ▶ Start the vehicle again.

- ▶ Shift the transmission to position **D** or **R**. If **D** is selected, the transmission only shifts to one gear; if **R** is selected, the transmission shifts to reverse gear.
- ▶ Have the transmission checked at a qualified specialist workshop immediately.

### Manual gearshifting

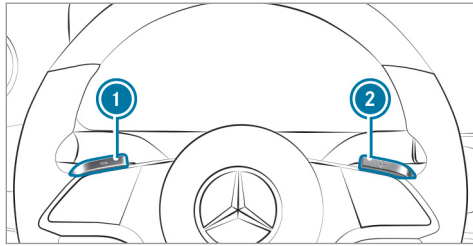

When the automatic transmission is shifted to position **D**, you can manually shift it with the steering wheel gearshift paddle. If permitted, the automatic transmission shifts to a higher or lower gear depending on the steering wheel gearshift paddle being pulled.

You have two options to manually shift the automatic transmission:

- Temporary setting
- Permanent setting

The gears shift automatically when manual shifting is deactivated.

#### Temporary setting:

- ▶ **To activate:** pull steering wheel gearshift paddle **1** or **2**. Manual shifting is activated for a short time. The transmission position display shows **M** and the current gear.

**i** How long the manual shifting stays activated is dependent on various factors.

Manual shifting can be automatically deactivated in the following cases:

- Changing the drive program
- Restarting the vehicle
- When the transmission position **D** is engaged again
- Driving style

- ▶ **To shift up:** pull steering wheel gearshift paddle **2**.
- ▶ **To shift down:** pull steering wheel gearshift paddle **1**.
- ▶ **To deactivate:** pull steering wheel gearshift paddle **2** and hold it in place. The transmission position display shows **D**.

#### Permanent setting:

- ▶ Change to drive program **I\*** (→ page 147).
- ▶ Select drive setting **M** (→ page 147).

### Gearshift recommendation

The gearshift recommendation assists you in adopting an economical driving style.

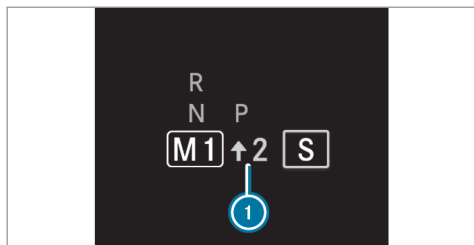

- ▶ If gearshift recommendation  appears next to the transmission position display, shift to the recommended gear.

### Using kickdown

- ▶ **Maximum acceleration:** depress the accelerator pedal beyond the pressure point.

To protect against engine overrev, the automatic transmission shifts up to the next gear when maximum engine speed has been reached.

### Glide mode function

#### NOTE Mercedes-AMG vehicles

- ▶ Observe the notes in the Supplement. You could otherwise fail to recognize dangers.

With an anticipatory driving style, Glide mode helps you to reduce fuel consumption.



Glide mode is characterized by the following:

- The combustion engine is disconnected from the drivetrain and continues to run in neutral.
- The transmission position display  is shown in green.
- **Vehicles with 48 V on-board electrical system:** the combustion engine can be switched off. All of the vehicle functions remain active.

Glide mode is activated if the following conditions are met:

- Drive program  is selected.
- The speed is within a suitable range.

- The road's course is suitable, e.g. no steep uphill or downhill inclines or tight curves.
- You do not depress the accelerator or brake pedal (except for light brake applications).

-  Glide mode can also be activated if you have selected the "Eco" setting for the drive in the drive program .

Glide mode is deactivated again if one of the conditions is no longer met.

Glide mode can also be prevented by the following parameters:

- Incline
- Downhill gradient
- Temperature
- Height
- Speed
- Operating status of the engine
- Traffic situation

### Function of the 4MATIC

4MATIC ensures that all four wheels are driven. Together with ESP® and 4ETS, 4MATIC improves the traction of your vehicle whenever a driven wheel spins due to insufficient traction.

If you fail to adapt your driving style, 4MATIC can neither reduce the risk of an accident nor override the laws of physics. 4MATIC cannot take account of road, weather and traffic conditions. 4MATIC is only an aid. You are responsible especially for maintaining a safe distance from the vehicle in front, for vehicle speed, for braking in good time and for staying in lane.

- ❶ In wintry road conditions, the maximum effect of 4MATIC can be achieved only if you use winter tires (M+S tires), with snow chains if necessary.

### Refueling

#### Refueling the vehicle

**⚠ WARNING** Risk of fire or explosion from fuel

Fuels are highly flammable.

- ▶ Fire, open flames, smoking and creating sparks must be avoided.
- ▶ Before refueling, switch off the vehicle and, if installed, the stationary heater, and leave them switched off during refueling.

**⚠ WARNING** Risk of injury from fuels

Fuels are poisonous and hazardous to your health.

- ▶ Do not swallow fuel or let it come into contact with skin, eyes or clothing.
- ▶ Do not inhale fuel vapor.
- ▶ Keep children away from fuel.

- ▶ Keep doors and windows closed during the refueling process.

If you or other people come into contact with fuel, observe the following:

- ▶ Immediately rinse fuel off your skin with soap and water.
- ▶ If fuel comes into contact with your eyes, immediately rinse them thoroughly with clean water. Seek medical attention immediately.
- ▶ If you swallow fuel, seek medical attention immediately. Do not induce vomiting.
- ▶ Change immediately out of clothing that has come into contact with fuel.

**⚠ WARNING** Risk of fire and explosion due to electrostatic charge

Electrostatic charge can ignite fuel vapor.

- ▶ Before you open the fuel filler cap or take hold of the pump nozzle, touch the metallic vehicle body.
- ▶ To avoid creating another electrostatic charge, do not get into the vehicle again during the refueling process.

**!** **NOTE** Damage caused by the wrong fuel

Vehicles with a gasoline engine:

Even small amounts of the wrong fuel could result in damage to the fuel system, the engine and the emission control system.

- ▶ Only refuel with low-sulfur spark-ignition engine fuel.

This fuel may contain up to 10% ethanol. Your vehicle is suitable for use with E10 fuel.

Never refuel with one of the following fuels:

- Diesel
- Gasoline with more than 10% ethanol by volume, e.g. E15, E85, E100

- Gasoline with more than 3% methanol by volume, e.g. M15, M30, M85, M100
- Gasoline with additives containing metal

If you have accidentally refueled with the wrong fuel:

- ▶ Do not switch on the vehicle.
- ▶ Consult a qualified specialist workshop.

**!** **NOTE** Do not use diesel to refuel vehicles with a gasoline engine

If you have accidentally refueled with the wrong fuel:

- Do not switch on the vehicle. Otherwise fuel can enter the engine.

Even small amounts of the wrong fuel could result in damage to the fuel system and the engine. The repair costs are high.

- ▶ Consult a qualified specialist workshop.
- ▶ Have the fuel tank and fuel lines drained completely.

**!** **NOTE** Damage to the fuel system caused by overfilled fuel tanks

- ▶ Only fill the fuel tank until the pump nozzle switches off.

**!** **NOTE** Fuel may spray out when you remove the fuel pump nozzle

- ▶ Only fill the fuel tank until the pump nozzle switches off.

**Requirements:**

- The vehicle is unlocked.
- i** Do not get into the vehicle again during the refueling process. Otherwise, electrostatic charge could build up again.

Observe the notes on operating fluids and fuel.

Only refuel with fuel that has at least the octane number specified in the information label in the fuel filler flap. Otherwise, engine output can be reduced and fuel consumption increased.

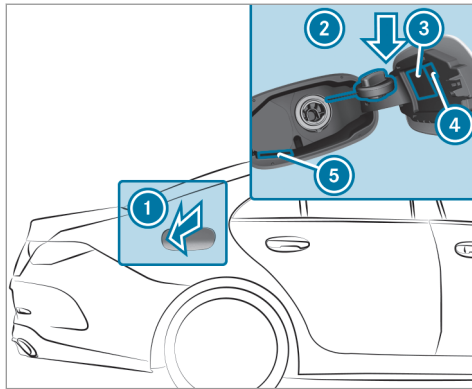

- ① Fuel filler flap
- ② Bracket for fuel filler cap
- ③ Tire pressure table
- ④ QR code for rescue card
- ⑤ Fuel type

- ▶ Press on the back area of fuel filler flap ①.
- ▶ Turn the fuel filler cap counter-clockwise and remove it.

- ▶ Insert fuel filler cap from above into bracket ②.
- ▶ Completely insert the pump nozzle into the tank filler neck, hook in place and refuel.
- ▶ Only fill the fuel tank until the pump nozzle switches off.
- ▶ Replace the cap on the filler neck and turn clockwise until it engages audibly.
- ▶ Close fuel filler flap ①.

## Parking

### Parking the vehicle

- ⚠ **WARNING** Risk of accident and injury caused by an insufficiently secured vehicle rolling away

If the vehicle is not securely parked sufficiently, it can roll away in an uncontrolled way even at a slight downhill gradient.

- ▶ On uphill or downhill gradients, turn the front wheels so that the vehicle rolls towards the curb if it starts moving.

- ▶ Apply the parking brake.
- ▶ Switch the transmission to position **P**.

- ⚠ **WARNING** Risk of fire caused by hot exhaust system parts

Flammable materials such as leaves, grass or twigs may ignite.

- ▶ Park the vehicle so that no flammable material can come into contact with hot vehicle components.
- ▶ In particular, do not park on dry grass-land or harvested grain fields.

- ⚠ **WARNING** Risk of accident and injury due to children left unattended in the vehicle

If children are left unsupervised in the vehicle, they could, in particular:

- open doors, thereby endangering other persons or road users.
- get out and be struck by oncoming traffic.

- operate vehicle equipment and become trapped, for example.

In addition, the children could also set the vehicle in motion, for example by:

- releasing the parking brake.
  - changing the transmission position.
  - starting the vehicle.
- ▶ Never leave children unattended in the vehicle.
- ▶ When leaving the vehicle, always take the SmartKey with you and lock the vehicle.
- ▶ Keep the vehicle SmartKey out of reach of children.

**!** **NOTE** Damage to the vehicle due to it rolling away

- ▶ Always secure the vehicle against rolling away.

**!** **NOTE** Damage due to the vehicle lowering

**Vehicles with AIR BODY CONTROL or level control:** The vehicle can lower because of temperature differences or longer non-operational times. This can cause damage to parts of the body.

- ▶ When stopping the vehicle and when driving off, make sure that there are no obstacles such as curbs under or in the immediate vicinity of the body.

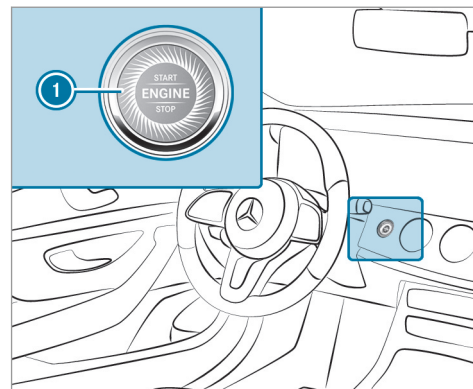

- ▶ Bring the vehicle to a standstill by pressing the brake pedal.
- ▶ On gradients, turn the front wheels so that the vehicle will roll towards the curb if it starts moving.
- ▶ Apply the electric parking brake.



- ▶ Engage transmission position **P** in a stationary vehicle with the brake pedal applied (→ page 150).
  - ▶ Switch off the vehicle by pressing button ①.
  - ▶ Release the service brake slowly.
  - ▶ Get out of the vehicle and lock it.
- ① When you park the vehicle, you can still operate the side windows and the sliding sunroof for approximately four minutes if the driver's door is closed.

### Garage door opener

#### Programming buttons for the garage door opener

**⚠ DANGER** Risk of fatal injuries caused by exhaust gases

Combustion engines emit poisonous exhaust gases, such as carbon monoxide. Inhaling these exhaust gases is hazardous to health and leads to poisoning.

- ▶ Never run the vehicle and, if present, the stationary heater indoors without sufficient ventilation.

**⚠ WARNING** Risk of injury by becoming trapped when opening and closing a garage door

When you operate or program a garage door with an integrated garage door opener, persons can become trapped or struck by the garage door if they stand within its range of movement.

- ▶ Always make sure that nobody is within the range of the garage door's movement.

Only operate the following doors using the garage door opener:

- Doors with a safety stop and reversing feature
- Doors which conform to the current U.S. safety standards

#### Requirements:

- The vehicle has been parked outside the garage or outside the range of movement of the door.
  - The vehicle is switched on.
  - The vehicle has not been started.
- ① The garage door opener function is always available when the vehicle is switched on.

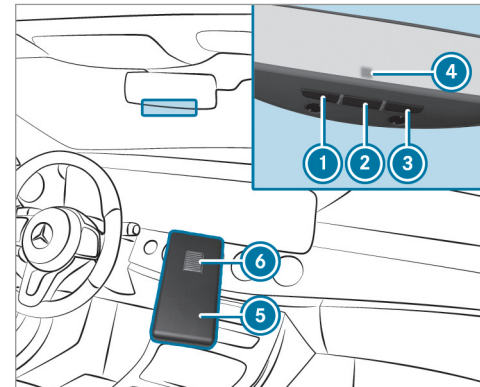

▶ Check if the transmitter frequency of the remote control has the frequency range of 280 to 868 MHz.

Radio equipment approval number:

- NZLMUAHL5 (USA)
- 4112A-MUAHL5 (Canada)

▶ Press and hold button ①, ② or ③ that you wish to program.

Indicator lamp ④ flashes yellow.

ⓘ It can take up to 20 seconds before the indicator lamp flashes yellow.

▶ Release the previously pressed button.  
Indicator lamp ④ continues to flash yellow.

▶ Point remote control ⑤ from a distance of 0.4 in (1 cm) to 3 in (8 cm) towards button ①, ② or ③.

▶ Press and hold button ⑥ of remote control ⑤ until one of the following signals appears:

- Indicator lamp ④ lights up green continuously. Programming is complete.
- Indicator lamp ④ flashes green. Programming was successful. Additionally, syn-

chronization of the rolling code with the door system must be carried out.

▶ If indicator lamp ④ does not light up or flash green: repeat the procedure.

▶ Release all of the buttons.

ⓘ The remote control for the door drive is not included in the scope of delivery of the garage door opener.

### Synchronizing the rolling code

#### Requirements:

- The door system uses a rolling code.
- The vehicle must be within range of the garage door or door drive.
- The vehicle as well as persons and objects are located outside the range of movement of the door.

▶ Press the programming button on the door drive unit.  
Initiate the next step within approximately 30 seconds.

▶ Press previously programmed button ①, ② or ③ repeatedly until the door closes.  
When the door closes, programming is completed.

ⓘ Please also read the operating instructions for the door drive.

### Troubleshooting when programming the remote control

▶ Check if the transmitter frequency of remote control ⑤ is supported.

▶ Replace the batteries in remote control ⑤.

▶ Hold remote control ⑤ at various angles from a distance of 0.4 in (1 cm) to 3 in (8 cm) front of the inside rearview mirror. You should test every position for at least 25 seconds before trying another position.

▶ Hold remote control ⑤ at the same angles at various distances in front of the inside rearview mirror. You should test every position for at least 25 seconds before trying another position.

- ▶ On remote controls that transmit only for a limited period, press button ⑥ on remote control ⑤ again before transmission ends.
- ▶ Angle the antenna line of the garage door opener unit towards the remote control.
- ① Support and additional information on programming:
  - On the toll free HomeLink® Hotline on 1-800-355-3515
  - On the Internet at <https://www.homelink.com/mercedes>

### Opening or closing the garage door

#### Requirements:

- The corresponding button is programmed to operate the door.
- ▶ Press and hold buttons ①, ② or ③ until the door opens or closes.
- ▶ If indicator lamp ④ flashes yellow after approximately 20 seconds: press and hold the previously pressed button again until the door opens or closes.

### Clearing the garage door opener memory

- ▶ Press and hold buttons ① and ③. Indicator lamp ④ lights up yellow.
- ▶ If indicator lamp ④ flashes green: release buttons ① and ③. The entire memory has been deleted.

### Electric parking brake

#### Function of the electric parking brake (applying automatically)

**⚠ WARNING** Risk of accident and injury due to children left unattended in the vehicle

If children are left unsupervised in the vehicle, they could, in particular:

- open doors, thereby endangering other persons or road users.
- get out and be struck by oncoming traffic.
- operate vehicle equipment and become trapped, for example.

In addition, the children could also set the vehicle in motion, for example by:

- releasing the parking brake.
- changing the transmission position.
- starting the vehicle.
- ▶ Never leave children unattended in the vehicle.
- ▶ When leaving the vehicle, always take the SmartKey with you and lock the vehicle.
- ▶ Keep the vehicle SmartKey out of reach of children.

**The electric parking brake is applied if the transmission is in position **P** and one of the following conditions is fulfilled:**

- The vehicle is switched off.
- The seat belt tongue is not inserted in the seat belt buckle of the driver's seat and the driver's door is opened.
- ① To prevent application: pull the handle of the electric parking brake (→ page 160).

**In the following situations, the electric parking brake is also applied:**

- The HOLD function is keeping the vehicle stationary.
- Active Parking Assist is keeping the vehicle stationary.
- Active Distance Assist DISTRONIC is bringing the vehicle to a standstill.
- **In addition, one of the following conditions must be fulfilled:**
  - The vehicle is switched off.
  - The seat belt tongue is not inserted in the seat belt buckle of the driver's seat and the driver's door is opened.
  - There is a system malfunction.
  - The power supply is insufficient.
  - The vehicle is stationary for a lengthy period.

When the electric parking brake is applied, the red **PARK** (USA) or **(P)** (Canada) indicator lamp lights up in the instrument cluster.

- **i** The electric parking brake is not automatically applied if the vehicle is switched off by the ECO start/stop function.

**Function of the electric parking brake (releasing automatically)**

**The electric parking brake is released when the following conditions are fulfilled:**

- The driver's door is closed.
- The vehicle has been started.
- The transmission is in position **D** or **R** and you depress the accelerator pedal or you shift from transmission position **P** to **D** or **R** when on level ground.
- If the transmission is in position **R**, the trunk lid must be closed.
- The seat belt tongue is inserted into the seat belt buckle of the driver's seat.

If the seat belt tongue is not inserted into the seat belt buckle of the driver's seat, one of the following conditions must be fulfilled:

- You shift from transmission position **P**.
- or

- You have previously driven at speeds greater than 2 mph (3 km/h).

When the electric parking brake is released, the red **PARK** (USA) or **(P)** (Canada) indicator lamp in the instrument cluster goes out.

**Applying/releasing the electric parking brake manually**

**Applying**

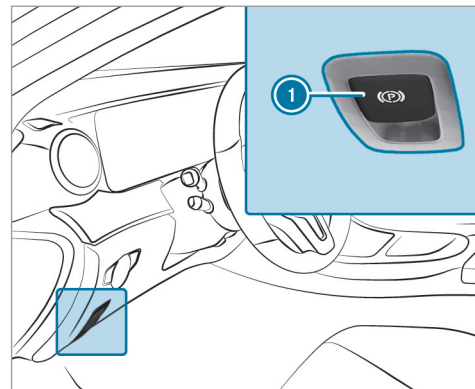

- ▶ Push handle ①.  
The red **PARK** (USA) or **(P)** (Canada) indicator lamp lights up in the instrument cluster.
- ① The electric parking brake is only securely applied if the red **PARK** (USA) or **(P)** (Canada) indicator lamp is lit continuously.

### Releasing

- ▶ Switch on the vehicle.
- ▶ Pull handle ①.  
The red **PARK** (USA) or **(P)** (Canada) indicator lamp in the instrument cluster goes out.

### Emergency braking

- ▶ Press and hold handle ①.  
As long as the vehicle is driving, the **Please Release Parking Brake** message is displayed and the red **PARK** (USA) or **(P)** (Canada) indicator lamp flashes.
- When the vehicle has been braked to a standstill, the electric parking brake is applied. The red **PARK** (USA) or **(P)** (Canada) indicator lamp lights up in the instrument cluster.

### Information on collision detection on a parked vehicle

If a collision is detected when the tow-away alarm is armed on a locked vehicle, you will receive a notification in the multimedia system when you switch the vehicle on.

You will receive information about the following points:

- The area of the vehicle that may have been damaged.
- The force of the impact.

The following situation can lead to inadvertent activation:

- The parked vehicle is moved, for example, in a two-story garage.
- ① Disarm the tow-away alarm in order to prevent inadvertent activation. If you disarm the tow-away alarm, collision detection will also be deactivated.
- ① If the battery is severely discharged, the function for detecting a collision on a parked vehicle

is automatically deactivated to facilitate the next engine start.

### System limits

Detection may be restricted in the following situations:

- The vehicle is damaged without impact, for example, if an outside mirror is torn off or the paint is damaged by a key
- An impact occurs at low speed
- The electric parking brake is not applied

### Notes on parking the vehicle for an extended period

If you leave the vehicle parked for longer than six weeks, it may suffer damage through disuse.

The 12 V battery may also be impaired or damaged by heavy discharging.

- ① Further information can be obtained at a qualified specialist workshop.

### Standby mode (extension of the starter battery's period out of use)

#### Standby mode function

 This function is not available for all models.

If standby mode is activated, energy loss will be minimized during extended periods of non-operation.

Standby mode is characterized by the following:

- The starter battery is preserved.
- The maximum non-operational time appears in the media display.
- The connection to online services is interrupted.
- The ATA (anti-theft alarm system) is not available.
- The interior motion sensor and tow-away alarm functions are not available.
- The function for detecting collisions on a parked vehicle is not available.

If the following conditions are fulfilled, standby mode can be activated or deactivated using the multimedia system:

- The vehicle is switched on.
- The vehicle has not been started.

Exceeding the vehicle's displayed non-operational time may cause inconvenience; i.e. it cannot be guaranteed that the starter battery will reliably start the vehicle.

Charge the starter battery in the following situations:

- The vehicle's non-operational time must be extended.
- The **Battery Charge Insufficient for Standby Mode** message appears in the media display.

 Standby mode is automatically deactivated when the vehicle is switched on.



#### Activating/deactivating standby mode (parking the vehicle for an extended period)

##### Requirements:

- The engine is switched off.

Multimedia system:

  Settings  Vehicle

-  Activate or deactivate **Standby Mode**.
-  Select **Yes**.

### Driving and driving safety systems

#### Driving systems and your responsibility

Your vehicle is equipped with driving systems which assist you in driving, parking and maneuvering the vehicle. The driving systems are only aids. They are not a substitute for your attention to the surroundings and do not relieve you of your responsibility pertaining to road traffic law. The driver is always responsible for maintaining a safe distance to the vehicle in front, for vehicle speed, for braking in good time and for staying in lane. Pay attention to the traffic conditions at all times and intervene when necessary. Be aware of the limitations regarding the safe use of these systems.

Driving systems can neither reduce the risk of accident if you fail to adapt your driving style nor override the laws of physics. They cannot always

take into account road, weather or traffic conditions.

### Information on vehicle sensors and cameras

Some driving and driving safety systems use cameras as well as radar or ultrasonic sensors to monitor the area in front of, behind or next to the vehicle.

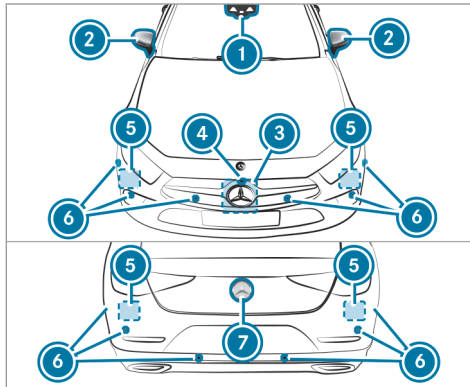

- ① Multifunction camera
- ② Cameras in the outside mirrors
- ③ Front radar
- ④ Front camera
- ⑤ Corner radars
- ⑥ Ultrasonic sensors
- ⑦ Rear view camera

**⚠ WARNING** Risk of accident due to restricted detection performance of vehicle sensors and cameras

If the area around vehicle sensors or cameras is covered, damaged or dirty, certain driving and safety systems cannot function correctly. There is a risk of an accident.

- ▶ Keep the area around vehicle sensors or cameras clear of any obstructions and clean.
- ▶ Have damage to the bumper, radiator grille or stone chipping in the area of the front and rear windows repaired at a qualified specialist workshop.

Particularly, keep the areas around the sensors and cameras free of dirt, ice or slush (→ page 277). The sensors and cameras must not be covered and the detection ranges around them must be kept free. Do not attach additional license plate bracket, advertisements, stickers, foils or foils to protect against stone chippings in the detection range of the sensors and cameras. Make sure that there are no overhanging loads protruding into the detection range.

If there is damage to a bumper or the radiator grille, or after an impact, have the function of the sensors checked at a qualified specialist workshop. Have damage or stone chipping in the area of the cameras on the front and rear windows repaired at a qualified specialist workshop.

- ① The rear view camera can extend and retract automatically for the purpose of calibration, even though there is no camera image in the display.

### Overview of driving systems and driving safety systems

- ABS (**A**nti-**l**ock **B**raking **S**ystem) (→ page 164)

- BAS (**B**rake **A**ssist **S**ystem) (→ page 165)
- ESP® (**E**lectronic **S**tability **P**rogram) (→ page 165)
- ESP® Crosswind Assist (→ page 166)
- EBD (**E**lectronic **B**rakeforce **D**istribution) (→ page 167)
- STEER CONTROL (→ page 167)
- HOLD function (→ page 167)
- Hill Start Assist (→ page 168)
- ATTENTION ASSIST (→ page 168)
- Cruise control (→ page 170)
- Traffic Sign Assist (→ page 188)
- DYNAMIC BODY CONTROL (→ page 196)
- AIR BODY CONTROL (→ page 196)
- Active Distance Assist DISTRONIC (→ page 172)
- Active Speed Limit Assist (country-dependent) (→ page 176)
- Route-based speed adaptation (country-dependent) (→ page 177)
- Active Brake Assist (→ page 183)
- Active Steering Assist (country-dependent) (→ page 179)
- Active Emergency Stop Assist (country-dependent) (→ page 181)
- Active Lane Change Assist (country-dependent) (→ page 182)
- Active Stop-and-Go Assist (country-dependent) (→ page 178)
- Blind Spot Assist and Active Blind Spot Assist with exit warning (→ page 192)
- Active Lane Keeping Assist (→ page 194)

### Driving Assistance package

The following functions are part of the Driving Assistance Package. Certain functions are only available in some countries. Some functions are also available without the Driving Assistance Package, albeit with restricted functionality.

### Parking Package

- Rear view camera (→ page 199)
- Surround view camera (→ page 201)

- Parking Assist PARKTRONIC (→ page 204)
- Active Parking Assist (→ page 210)

### Function of ABS

The Anti-lock Brake System (ABS) regulates the brake pressure in critical driving situations:

- During braking, e.g. at maximum full-stop braking or insufficient tire traction, the wheels are prevented from locking.
- Vehicle steerability while braking is ensured.

If ABS intervenes when braking, you will feel a pulsing in the brake pedal. The pulsating brake pedal can be an indication of hazardous road conditions and can serve as a reminder to take extra care while driving.

### System limits

- ABS is active from speeds of approx. 5 mph (8 km/h).
- ABS may be impaired or may not function if a malfunction has occurred and the yellow  ABS warning lamp lights up continuously in



the instrument cluster after the drive system is started.

### Function of BAS

**⚠ WARNING** Risk of an accident caused by a malfunction in BAS (Brake Assist System)

If BAS is malfunctioning, the braking distance in an emergency braking situation is increased.

- ▶ Depress the brake pedal with full force in emergency braking situations. ABS prevents the wheels from locking.

The Brake Assist System (BAS) supports your emergency braking situation with additional brake force.

If you depress the brake pedal quickly, BAS is activated:

- BAS automatically boosts the brake pressure.
- BAS can shorten the braking distance.
- ABS prevents the wheels from locking.

The brakes will function as usual once you release the brake pedal. BAS is deactivated.

### Function of ESP®

**⚠ WARNING** Risk of skidding if ESP® is deactivated

If you deactivate ESP®, ESP® cannot carry out vehicle stabilization.

- ▶ ESP® should only be deactivated in the following situations.

**! NOTE** Mercedes-AMG vehicles

- ▶ Observe the notes in the Supplement. You could otherwise fail to recognize dangers.

The Electronic Stability Program (ESP®) can monitor and improve driving stability and traction in the following situations within physical limits:

- When pulling away on wet or slippery road.
- When braking.

If the vehicle deviates from the direction desired by the driver, ESP® can stabilize the vehicle by intervening in the following ways:

- One or more wheels are braked.
- The engine output is adapted according to the situation.

When ESP® is deactivated, the  warning lamp lights up continuously:

- Driving stability will no longer be improved.
- The drive wheels could spin.
- ETS/4ETS traction control is still active.

**i** When ESP® is deactivated, you are still assisted by ESP® when braking.

When the  warning lamp flashes, one or several wheels has reached its grip limit:

- Adapt your driving style to suit the current road and weather conditions.
- Do not deactivate ESP®.
- Only depress the accelerator pedal as far as is necessary when pulling away.

Deactivate ESP® in the following situations to improve traction:

- When using snow chains.
- In deep snow.
- On sand or gravel.

 Spinning the wheels results in a cutting action, which enhances traction.

If the  ESP® warning lamp lights up continuously, ESP® is not available due to a malfunction.

Observe the following information:

- Warning and indicator lamps (→ page 397)
- Display messages (→ page 345)

### ETS/4ETS (Electronic Traction System)

ETS/4ETS traction control is part of ESP® and makes it possible to pull away and accelerate on a slippery road.

ETS/4ETS can improve the vehicle's traction by intervening in the following ways:

- The drive wheels are braked individually if they spin.

- More drive torque is transferred to the wheel or wheels with traction.

### Influence of drive programs on ESP®

The drive programs enable ESP® to adapt to different weather and road conditions as well as the driver's preferred driving style. Depending on the selected drive program, the appropriate ESP® mode will be activated. You can select the drive programs using the DYNAMIC SELECT switch (→ page 147).

### Function of ESP® Crosswind Assist

ESP® Crosswind Assist detects sudden gusts of side wind and helps the driver to keep the vehicle in the lane:

- ESP® Crosswind Assist is active at vehicle speeds between approx. 47 mph (75 km/h) and 125 mph (200 km/h) when driving straight ahead or cornering slightly.
- The vehicle is stabilized by means of individual brake application on one side.

### Activating/deactivating ESP® (Electronic Stability Program)

Multimedia system:

   Settings  Quick Access

 ESP® can only be activated/deactivated using quick access when at least one other function is available in quick access. ESP® can otherwise be found in the Assistance menu.

#### NOTE Mercedes-AMG vehicles

 Observe the notes in the Supplement. You could otherwise fail to recognize dangers.

 Select ESP.

 Select On or  Off.

ESP® is deactivated if the  ESP® OFF warning lamp lights up continuously in the instrument cluster.

Observe the information on warning lamps and display messages which may be shown in the instrument cluster.

### Function of EBD

Electronic Brakeforce Distribution (EBD) is characterized by the following:

- Monitoring and regulating the brake pressure on the rear wheels.
- Improved driving stability when braking, especially on bends.

### Function of STEER CONTROL

STEER CONTROL assists you by transmitting a noticeable steering force to the steering wheel in the direction required for vehicle stabilization.

This steering recommendation is given in the following situations:

- Both right wheels or both left wheels are on a wet or slippery road surface when you brake
- The vehicle starts to skid

#### System limits

STEER CONTROL may be impaired or may not function in the following situations:

- ESP® is deactivated.

- ESP® is malfunctioning.
- The steering is malfunctioning.

If ESP® is malfunctioning, you will be assisted further by the electric power steering.

### HOLD function

#### HOLD function

The HOLD function holds the vehicle at a standstill without requiring you to depress the brake pedal, e.g. while waiting in traffic.

The HOLD function is only an aid. The responsibility for the vehicle safely standing still remains with the driver.

#### System limits

The HOLD function is only intended to provide assistance when driving and is not a sufficient means of safeguarding the vehicle against rolling away when stationary.

- The incline must not be greater than 30%.

### Activating/deactivating the HOLD function

**⚠ WARNING** Risk of an accident due to the HOLD function being active when you leave the vehicle

If the vehicle is only braked with the HOLD function it could, in the following situations, roll away:

- If there is a malfunction in the system or in the power supply.
- If the HOLD function is deactivated by depressing the accelerator pedal or brake pedal, e.g. by a vehicle occupant.

▶ Always secure the vehicle against rolling away before you leave it.

#### Requirements:

- The vehicle is stationary.
- The driver's door is closed or the seat belt on the driver's side is fastened.
- The vehicle has been started or has been automatically switched off by the ECO start/stop function.

- The electric parking brake is released.
- Active Distance Assist DISTRONIC is deactivated.
- The transmission is in position **D**, **R** or **N**.

#### Activating the HOLD function

- ▶ Depress the brake pedal, and after a short time quickly depress further until the **HOLD** display appears in the Instrument Display.
- ▶ Release the brake pedal.

#### Deactivating the HOLD function

- ▶ Depress the accelerator pedal to pull away.  
or
- ▶ Depress the brake pedal until the **HOLD** display disappears from the Instrument Display.

The HOLD function is deactivated in the following situations:

- Active Distance Assist DISTRONIC is activated.
- The transmission is shifted to position **P**.
- The vehicle is secured with the electric parking brake.

In the following situations, the vehicle is held by transmission position **P** and/or by the electric parking brake:

- The seat belt is unfastened and the driver's door is opened.
- The vehicle is switched off.
- There is a system malfunction.
- The power supply is insufficient.

#### Function of Hill Start Assist

Hill Start Assist holds the vehicle for a short time when pulling away on a hill under the following conditions:

- The transmission is in position **D** or **R**.
- The electric parking brake is released.

This gives you enough time to move your foot from the brake pedal to the accelerator pedal and depress it before the vehicle begins to roll away.

**⚠ WARNING** Risk of accident and injury due to the vehicle rolling away

After a short time, Hill Start Assist no longer holds the vehicle.

- ▶ Swiftly move your foot from the brake pedal to the accelerator pedal. Do not leave the vehicle when it is being held by Hill Start Assist.

#### ATTENTION ASSIST

##### Function of ATTENTION ASSIST

ATTENTION ASSIST assists you on long, monotonous journeys, e.g. on highways and trunk roads. If ATTENTION ASSIST detects indicators of fatigue or increasing lapses in concentration on the part of the driver, it suggests taking a break.

ATTENTION ASSIST is only an aid. It cannot always detect fatigue or lapses in concentration in time. The system is not a substitute for a well-rested and attentive driver. On long journeys, take regular breaks in good time that allow for adequate recuperation.

You can choose between two settings:

- **Standard:** normal system sensitivity.
- **Sensitive:** higher system sensitivity. The driver is warned earlier and the attention level detected by ATTENTION ASSIST is adapted accordingly.

If drowsiness or increasing lapses in concentration are detected, the **ATTENTION ASSIST: Take a Break!** warning appears in the Instrument Display. You can acknowledge the message and take a break if necessary. If you do not take a break and ATTENTION ASSIST continues to detect increasing lapses in concentration, you will be warned again after a minimum of 15 minutes.



You can have the following status information for ATTENTION ASSIST displayed in the assistance menu of the on-board computer:

- The length of the journey since the last break.
- The attention level determined by ATTENTION ASSIST:
  - The fuller the circle, the higher the attention level determined
  - As your attention wanes, the circle in the center of the display becomes smaller

If ATTENTION ASSIST is unable to calculate the attention level and cannot issue a warning, the **System Suspended** message appears.

If a warning is given in the Instrument Display, the multimedia system offers to search for a rest area. You can select a rest area and start navigation to this rest area. This function can be activated and deactivated in the multimedia system.

If ATTENTION ASSIST is deactivated, the  symbol appears in the assistance graphic in the Instrument Display. After the vehicle is started, ATTENTION ASSIST is automatically activated. The last selected sensitivity level remains stored.

### System limits

ATTENTION ASSIST is active in the 37 mph (60 km/h) to 124 mph (200 km/h) speed range.

Particularly in the following situations, ATTENTION ASSIST only functions in a restricted manner and warnings may be delayed or not occur:

- If you have been driving for less than approximately 30 minutes.
- If the road condition is poor (uneven road surface or potholes).
- If there is a strong side wind.
- If you adopt a sporty driving style (high cornering speeds or high rates of acceleration).
- If Active Steering Assist is activated and active (→ page 179).
- If the time has been set incorrectly.
- If you change lanes and vary your speed frequently in active driving situations.

The ATTENTION ASSIST drowsiness or alertness assessment is reset and restarted when continuing the journey in the following situations:

- You switch off the vehicle.

- If you unfasten your seat belt and open the driver's door (e.g. to change drivers or take a break).

### Setting ATTENTION ASSIST

Multimedia system:

-  >> Settings >> Assistance
- >> Attention Assist

### Setting options

- ▶ Select **Standard**, **Sensitive** or **Off**.

### Suggesting a rest area

- ▶ Select **Suggest Rest Area**.
- ▶ Activate or deactivate the function. If ATTENTION ASSIST detects fatigue or increasing lack of attention, it suggests a rest area in the vicinity.
- ▶ Select the suggested rest area. You are guided to the selected rest area.

### Speed control cruise control

#### Function of cruise control

Cruise control regulates the speed to the value selected by the driver.



If you accelerate to overtake, for example, the stored speed is not deleted. If you remove your foot from the accelerator pedal after overtaking, cruise control will resume speed regulation back to the stored speed.

You can store any speed above 15 mph (20 km/h) up to the maximum design speed.

Observe the notes on driving systems and your responsibility; you may otherwise fail to recognize dangers (→ page 162).

**Mercedes-AMG vehicles:** Cruise control is available up to a maximum speed of 155 mph (250 km/h).

#### Displays in the Instrument Display

-  (gray): cruise control is selected but not yet activated.
-  (green): cruise control is active.

A stored speed appears along with the  display.

- ❗ The segments between the stored speed and the end of the segment display light up in the speedometer.

#### System limits

Cruise control may be unable to maintain the stored speed on uphill gradients. The stored speed is resumed when the gradient evens out.

Change into a lower gear in good time on long and steep downhill gradients. Take particular note of this when driving a laden vehicle. By doing so, you will make use of the engine's braking effect. This relieves the load on the brake system and prevents the brakes from overheating and wearing too quickly.

Do not use cruise control in the following situations:

- In traffic situations which require frequent changes of speed, e.g. in heavy traffic, on winding roads

- On slippery roads. Accelerating can cause the drive wheels to lose traction and the vehicle could then skid.
- When visibility is poor

### Operating cruise control

**⚠ WARNING** Risk of accident due to stored speed

If you call up the stored speed and this is lower than your current speed, the vehicle decelerates.

- ▶ Take into account the traffic situation before calling up the stored speed.

### Requirements:

- Cruise control is selected.
- ESP® must be activated, but not intervening.
- The vehicle speed is at least 15 mph (20 km/h).
- The transmission is in position **D**.

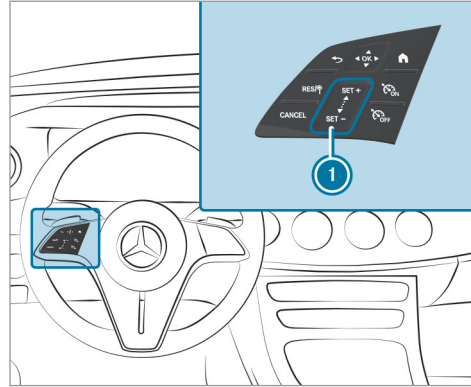

Steering wheel control panel for cruise control

- RES/+** Adopts the stored/detected speed
- CANCEL** Deactivates cruise control
- CC ON** Activates cruise control
- CC OFF** Deactivates cruise control
- 1** Control panel to increase/decrease speed

### Activating cruise control

- ▶ Press **CC ON**.

### Activating cruise control

- ▶ Press **SET/+** or **SET/-** on control panel **1**. The current speed is stored and maintained by the vehicle.

or

- ▶ Press **RES/+**. The last stored speed is called up and maintained by the vehicle. If the last stored speed has previously been deleted, the current vehicle speed is stored.

**i** When you switch off the vehicle, the last speed stored is deleted.

### Increasing/decreasing the stored speed

- ▶ To increase the stored speed: swipe upwards from the bottom of control panel **1**.
  - The stored speed is increased by 1 mph (1 km/h).
- ▶ To decrease the stored speed: swipe downwards from the top of control panel **1**.
  - The stored speed is decreased by 1 mph (1 km/h).

or

- ▶ Briefly press **SET+** or **SET-** on control panel .
 

The stored speed is increased or decreased to the following values depending on the unit:

- **mph:** the next value ending in 5
- **km/h:** the next value ending in 0

or

- ▶ Accelerate the vehicle to the desired speed.
- ▶ Press **SET+** on control panel .

#### Adopting a detected speed

If cruise control is activated and Traffic Sign Assist has detected a speed restriction sign with a maximum permissible speed and this is displayed in the instrument cluster:

- ▶ Press **RES/Ⓜ**.
 

The maximum permissible speed shown by the traffic sign is stored and the vehicle maintains this speed.

#### Deactivating cruise control

- ▶ Press **CANCEL**.

#### Deactivating cruise control

- ▶ Press .

-  If you brake, deactivate ESP® or if ESP® intervenes, cruise control is deactivated.

#### Active Distance Assist DISTRONIC

##### Function of Active Distance Assist DISTRONIC

Active Distance Assist DISTRONIC maintains the set speed on free-flowing roads. If vehicles in front are detected, the set distance is maintained, if necessary, until the vehicle comes to a halt. The vehicle accelerates or brakes depending on the distance to the vehicle in front and the set speed. The speed and distance to the vehicle in front are set and saved using the steering wheel.

Available speed range:

- **Vehicles without Driving Assistance Package:**  
15 mph (20 km/h) - 120 mph (200 km/h)
- **Vehicles with Driving Assistance Package:**  
15 mph (20 km/h) - 130 mph (210 km/h)

Other features of Active Distance Assist DISTRONIC:

- Adjusts the driving style depending on the selected drive program (fuel-saving, comfortable or dynamic)
- Initiates acceleration to the stored speed if the turn signal indicator is switched on to change to the overtaking lane
- **Vehicles with Driving Assistance Package:**
  - Reacts to stationary vehicles detected in urban speed ranges (except bicycles and motorcycles)
  - Takes one-sided overtaking restrictions into account on highways or on multi-lane roads with separate roadways (country-dependent)

**Vehicles with Driving Assistance Package and Parking Package:** if the vehicle has been braked to a standstill on multi-lane, separate roadways by Active Distance Assist DISTRONIC, it can automatically follow the vehicle in front when driving off again within 30 seconds. If a critical situation is detected when driving off, a visual and acoustic warning is given indicating that the driver must



now take control of the vehicle. The vehicle is not accelerated any further.

Observe the notes on driving systems and your responsibility; you may otherwise fail to recognize dangers (→ page 162).

### Active Distance Assist DISTRONIC displays in the Instrument Display

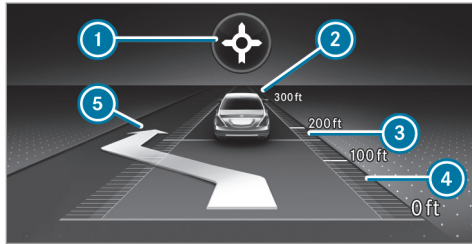

Assistance graphic

- ① Route-based speed adaptation: type of route event (→ page 177)
- ② Vehicle in front
- ③ Distance indicator

- ④ Set specified distance
- ⑤ Active Lane Change Assist lane change display

### Permanent status display of Active Distance Assist DISTRONIC

- (white): Active Distance Assist DISTRONIC selected, specified distance set
- (white vehicle, green speedometer): Active Distance Assist DISTRONIC active, specified distance set and vehicle detected
- (green): Active Distance Assist DISTRONIC active, specified distance set and vehicle detected
- : Route-based speed adaptation active (→ page 177).

The stored speed is shown along with the permanent status display and highlighted on the speedometer. When Active Distance Assist DISTRONIC is passive, the speed is grayed out.

- ① On highways or high-speed major roads, the green vehicle symbol is displayed cyclically when the vehicle is ready to pull away.

- ① If you depress the accelerator pedal beyond the setting of the Active Distance Assist DISTRONIC, the system is switched to passive mode. The **Suspended** message appears in the Instrument Display.

### Display on the speedometer

The stored speed is highlighted on the speedometer. If the speed of the vehicle in front or the speed adjustment for the route event ahead is less than the stored speed, the segments in the speedometer light up. The Instrument Display shows the deactivation of Active Distance Assist DISTRONIC, as well as alterations to the speed due to manual or automatic adoption of the maximum permissible speed.

### System limits

The system may be impaired or may not function in the following situations, for example:

- In snow, rain, fog, heavy spray, if there is glare, in direct sunlight or in greatly varying ambient light.
- The windshield in the area of the camera is dirty, fogged up, damaged or covered.

- If the radar sensors are dirty or covered.
- In parking garages or on roads with steep uphill or downhill gradients.
- If there are narrow vehicles in front, such as bicycles or motorcycles.

In addition, on slippery roads, braking or accelerating can cause one or several wheels to lose traction and the vehicle could then skid.

Do not use Active Distance Assist DISTRONIC in these situations.

**⚠ WARNING** Risk of accident from acceleration or braking by Active Distance Assist DISTRONIC

Active Distance Assist DISTRONIC may accelerate or brake in the following cases, for example:

- If the vehicle pulls away using Active Distance Assist DISTRONIC.
- If the stored speed is called up and is considerably faster or slower than the currently driven speed.

- If Active Distance Assist DISTRONIC no longer detects a vehicle in front or does not react to relevant objects.

- ▶ Always carefully observe the traffic conditions and be ready to brake at all times.
- ▶ Take into account the traffic situation before calling up the stored speed.

**⚠ WARNING** Risk of accident due to insufficient deceleration by Active Distance Assist DISTRONIC

Active Distance Assist DISTRONIC brakes your vehicle with up to 50% of the possible deceleration. If this deceleration is not sufficient, Active Distance Assist DISTRONIC alerts you with a visual and acoustic warning.

- ▶ Adjust your speed and maintain a suitable distance from the vehicle in front.
- ▶ Brake the vehicle yourself and/or take evasive action.

**⚠ WARNING** Risk of accident if detection function of Active Distance Assist DISTRONIC is impaired

Active Distance Assist DISTRONIC does not react or has a limited reaction:

- when driving on a different lane or when changing lanes
- to pedestrians, animals, bicycles or stationary vehicles, or unexpected obstacles
- to complex traffic conditions
- to oncoming vehicles and crossing traffic

As a result, Active Distance Assist DISTRONIC may neither give warnings nor intervene in such situations.

- ▶ Always observe the traffic conditions carefully and react accordingly.

### Operating Active Distance Assist DISTRONIC

#### Requirements:

- The electric parking brake is released.
- ESP® is activated and is not intervening.

- The transmission is in position **D**.
- All the doors are closed.
- Check of the radar sensor system has been successfully completed.

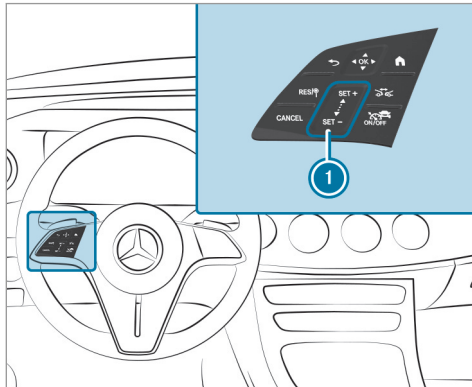

- RES/+** Adopts the stored/detected speed
- CANCEL** Deactivates Active Distance Assist DISTRONIC
- 1** Increases/decreases the speed

- Increases/decreases the specified distance
- Activates/deactivates Active Distance Assist DISTRONIC

▶ **To operate Active Distance Assist DISTRONIC:** press the respective button with only one finger or swipe on the control panel.

#### Activating/deactivating Active Distance Assist DISTRONIC

▶ Press .

#### Activating Active Distance Assist DISTRONIC

▶ **To activate without a stored speed:** on control panel **1** press **SET/+** on the upper section or **SET/-** on the lower section or **RES/+**. Remove your foot from the accelerator pedal.

or

▶ **To activate with a stored speed:** press **RES/+**. Remove your foot from the accelerator pedal. The current speed is stored and maintained by the vehicle.

#### Increasing or reducing the speed

- ▶ To increase the stored speed: swipe upwards from the bottom of control panel **1**.
- The stored speed is increased by 1 mph (1 km/h).
- ▶ To decrease the stored speed: swipe downwards from the top of control panel **1**.
- The stored speed is decreased by 1 mph (1 km/h).

or

▶ Briefly press **SET/+** on the upper section or **SET/-** on the lower section of control panel **1**. The stored speed is increased or reduced by 5 mph (10 km/h).

or

- ▶ Accelerate the vehicle to the desired speed.
- ▶ Press **SET/+** on the upper section of control panel **1**.

#### Adopting the limit speed shown in the instrument cluster

▶ Activate Active Distance Assist DISTRONIC.

- ▶ Press . The limit speed displayed in the instrument cluster is adopted as the stored speed. The vehicle adapts its speed to that of the vehicle in front, but only up to the stored speed.



### Pulling away with Active Distance Assist DISTRONIC

- ▶ Activate Active Distance Assist DISTRONIC and remove your foot from the brake pedal.
- ▶ Press .

or

- ▶ Depress the accelerator pedal briefly and firmly. The functions of Active Distance Assist DISTRONIC continue to be carried out.

### Reducing or increasing the specified distance from the vehicle in front

- ▶ Press . The  display appears. The specified distance is reduced by one level. If the lowest level is already selected, the selection jumps to the highest level.

### Deactivating Active Distance Assist DISTRONIC

**⚠ WARNING** Risk of an accident due to Active Distance Assist DISTRONIC being active when you leave the driver's seat

If you leave the driver's seat while the vehicle is being braked by Active Distance Assist DISTRONIC only, the vehicle can roll away.

- ▶ Always deactivate Active Distance Assist DISTRONIC and secure the vehicle to prevent it from rolling away before you leave the driver's seat.

- ▶ Press .

**i** If you brake, deactivate ESP® or if ESP® intervenes, Active Distance Assist DISTRONIC is deactivated.

### Function of Active Speed Limit Assist

If a change in the speed limit of 12 mph (20 km/h) or more is detected and automatic adoption of speed limits is activated, the new speed limit is automatically adopted as the stored speed (→ page 189).

The driven speed is adjusted when the vehicle is level with the traffic sign at the latest. In the case of signs indicating entry into an urban area, the speed is adapted according to the speed permitted within the urban area. The speed limit display in the Instrument Display is always updated when the vehicle is level with the traffic sign.

If there is no speed restriction on an unlimited stretch of road (e.g. on a freeway), the recommended speed is automatically adopted as the stored speed. The system uses the speed stored on an unlimited stretch of road as the recommended speed. If you do not alter the stored speed on an unlimited stretch of road, the recommended speed is 80 mph (130 km/h).

If Active Distance Assist DISTRONIC has been put into passive mode by pressing the accelerator pedal, only speed limits which are higher than the set speed are adopted.

Observe the notes on driving systems and your responsibility; you may otherwise fail to recognize dangers (→ page 162).

### System limits

The system limits of Traffic Sign Assist apply to the detection of traffic signs (→ page 188).

Speed limits below 12 mph (20 km/h) are not automatically adopted by the system as the stored speed. Temporary speed restrictions (e.g. for a certain time or due to weather conditions) cannot be properly detected by the system. The maximum permissible speed applying to a vehicle with a trailer is not detected by the system.

Adjust the speed in these situations.

**⚠ WARNING** Risk of accident due to Active Speed Limit Assist adapting the vehicle's speed

The speed adopted by Active Speed Limit Assist may be too high or incorrect in some individual cases, such as:

- at speed limits below 12 mph (20 km/h)
- in wet conditions or in fog
- when towing a trailer

- ▶ Ensure that the driven speed complies with traffic regulations.
- ▶ Adjust the driving speed to suit current traffic and weather conditions.

### Function of route-based speed adaptation

When Active Distance Assist DISTRONIC is activated, the vehicle speed will be adapted accordingly to the route events ahead. Depending on the drive program selected, the vehicle negotiates a route event ahead in an economical, comfortable or dynamic manner. When the route event has been passed, the vehicle accelerates again to the stored speed. The set distance to the vehicle in front, vehicles detected ahead and speed restrictions ahead are taken into account.

You can activate and deactivate route-based speed adaptation in the multimedia system (→ page 178).

The following route events are taken into account:

- Curves
- T-intersections, roundabouts and toll plazas
- Turns and exits

- Traffic jams ahead (only with Live Traffic Information )

**i** When the toll station is reached, Active Distance Assist DISTRONIC adopts the speed as the stored speed.

Also, the speed is reduced if the turn signal indicator to change lanes is switched on and one of the following situations is detected:

- Turning off at intersections
- Driving on slowing-down lanes
- Driving on lanes adjacent to slowing-down lanes

The driver is responsible for choosing the right speed and observing other road users. This applies in particular to intersections, roundabouts and traffic lights, as route-based speed adaptation does not brake the vehicle to a standstill.

When route guidance is active, the first speed adjustment is carried out automatically. If the turn signal indicator is switched on, the selected route is confirmed and further speed adjustment is activated.

Speed adaptation is canceled in the following cases:

- If the turn signal indicator is switched off before the route event.
- If the driver depresses the accelerator or brake pedal during the process.

### System limits

Route-based speed adaptation does not take right of way regulations into account. The driver is responsible for complying with road traffic regulations and driving at a suitable speed.

The speed adaptation made by the system may not always be suitable, particularly in the following situations:

- The road's course not clearly visible
- Road narrowing
- Varying maximum permissible speeds in individual lanes, for example at toll plazas
- Wet road surfaces, snow or ice

In these situations the driver must intervene accordingly.

### **WARNING** Risk of accident in spite of route-based speed adaptation

Route-based speed adaptation can malfunction or be temporarily unavailable in the following situations:

- If the driver does not follow the calculated route
- If map data is not up-to-date or available
- In the event of roadworks
- In bad weather or road conditions
- If the accelerator pedal is depressed
- In the event of electronically displayed speed limitations

 Adapt the speed to the traffic situation.

### Setting route-based speed adaptation

#### Requirements:

- Active Distance Assist DISTRONIC is activated.
- ECO Assist is active.

Multimedia system:

   **Settings**  **Assistance**  
 **Route-based Speed**

 Activate or deactivate the function. When the function is active, the vehicle speed is adjusted depending on the route events ahead.

 Further information on the route-based speed adaptation (→ page 177).

### Function of Active Traffic Jam Assist

Active Traffic Jam Assist helps you when in traffic jams on multi-lane roads with separate roadways by automatically pulling away within 60 seconds and with moderate steering maneuvers. It orients itself using the vehicle in front and lane markings. Active Traffic Jam Assist automatically maintains a safe distance from the vehicle in front and vehicles cutting in.

Active Traffic Jam Assist requires you, as the driver, to keep your hands on the steering wheel at all times so that you are able to intervene at any time to correct the course of the vehicle and keep it in lane. Observe the notes on driving sys-

tems and your responsibility; you may otherwise fail to recognize dangers (→ page 162).

Active Traffic Jam Assist activates automatically as soon as all of the requirements are met: The  status display appears in the instrument cluster when the function is active.

Requirements:

- You are in a traffic jam on a freeway or high-speed major road.
- Active Distance Assist DISTRONIC is activated and active (→ page 174).
- Active Brake Assist is available (→ page 183).
- Active Steering Assist is activated and active (→ page 181).
- Active Traffic Jam Assist is activated (→ page 179).
- You are traveling no faster than 35 mph (60 km/h).

### System limits

The system limitations of Active Distance Assist DISTRONIC and Active Steering Assist apply to Active Traffic Jam Assist.

### Activating/deactivating Active Traffic Jam Assist

Multimedia system:

  **Settings**  **Quick Access**

 Select .

### Active Steering Assist

#### Function of Active Steering Assist







Active Steering Assist is only available up to a speed of 130 mph (210 km/h). The system helps you to stay in the center of the lane by means of moderate steering interventions. Depending on the speed driven, Active Steering Assist uses the vehicles ahead and lane markings as a reference.

- ① Depending on the country, in the lower speed range Active Steering Assist can use the surrounding traffic as a reference. If necessary, Active Steering Assist can then also provide assistance when driving away from the center of the lane, for example, to form a rescue lane.

If the detection of lane markings and vehicles ahead is impaired, Active Steering Assist switches

to passive mode. The system provides no support in this case.

#### Status display of Active Steering Assist in the Instrument Display

-  (gray): activated and passive
  -  (green): activated and active
  -  (red): system limits detected
  -  (white, red hands): "hands on the steering wheel" prompt
- ① During the transition from active to passive status, the  symbol is shown as enlarged and flashing. Once the system is passive, the  symbol is shown as gray in the Instrument Display.
  - ① Depending on the selected vehicle settings, Active Steering Assist may be unavailable.

#### Steering and touch detection

The driver is required to keep their hands on the steering wheel at all times and be able to intervene at any time to correct the course of the vehicle and keep it in lane. The driver must expect a

change from active to passive mode or vice versa at any time.



If the system detects that the driver has not steered the vehicle for a considerable period of time or has removed their hands from the steering wheel, display ❶ appears. If the driver still does not steer the vehicle, a warning tone sounds in addition to the visual warning message.

If the driver does not react to the warning for a considerable period, the system can initiate an emergency stop (→ page 181).

If the driver steers, no warning is issued, or the warning is ended.

If Active Steering Assist detects that a system limit has been reached, a visual warning is issued and a warning tone sounds.

Observe the notes on driving systems and your responsibility; you may otherwise fail to recognize dangers (→ page 162).

### System limits

Active Steering Assist has a limited steering torque for lateral guidance. In some cases, the steering intervention is not sufficient to keep the vehicle in the lane or to drive through exits.

The system may be impaired or may not function in the following instances:

- There is poor visibility, e.g. due to snow, rain, fog, heavy spray, greatly varying ambient light or strong shadows on the road.
- There is glare, e.g. from oncoming traffic, direct sunlight or reflections.
- Insufficient road illumination.
- The windshield is dirty, fogged up, damaged or covered in the vicinity of the camera, e.g. by a sticker.

- No, or several, unclear lane markings are present for one lane, or the markings change quickly, for example, in a construction area or intersections.
- The lane markings are worn away, dark or covered up, e.g. by dirt or snow.
- If the distance to the vehicle in front is too short and thus the lane markings cannot be detected.
- The road is narrow and winding.
- There are obstacles on the lane or projecting out into the lane, such as object markers.

The system does not provide assistance in the following conditions:

- On tight curves and when turning.
- When crossing intersections.
- At roundabouts or toll stations.
- When the tire pressure is too low.



**⚠ WARNING** Risk of accident if Active Steering Assist unexpectedly stops functioning

If the system limits of Active Steering Assist are reached there is no guarantee that the system will remain active or will keep the vehicle in lane.

- ▶ Always keep your hands on the steering wheel and observe the traffic carefully.
- ▶ Always steer the vehicle paying attention to traffic conditions.

**⚠ WARNING** Risk of accident if Active Steering Assist unexpectedly intervenes

The detection of lane markings and objects may malfunction and cause unexpected steering interventions.

- ▶ Steer according to traffic conditions.



### Activating/deactivating Active Steering Assist

#### Requirements:

- ESP® is activated, but is not intervening.

- Active Distance Assist DISTRONIC is activated.

Multimedia system:

- ➔  ➔ Settings ➔ Quick Access
- ▶ Select  Steering Assist.

### Function of Active Emergency Stop Assist

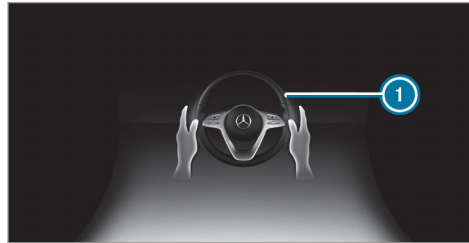

If the system detects that the driver has not steered the vehicle for a considerable period of time or has removed their hands from the steering wheel, display ① appears in the Instrument Display. If the driver still does not steer the vehicle, or gives no confirmation to the system, a warning

tone sounds in addition to the visual warning message.

If the driver still does not respond to the warning, the **Beginning Emergency Stop** message appears in the Instrument Display. If the driver still does not respond, Active Distance Assist DISTRONIC reduces the speed. The vehicle is decelerated in stages to a standstill.

Depending on the country, at speeds below 40 mph (60 km/h) the hazard warning lights switch on automatically.

When the vehicle is stationary, the following actions are carried out:

- The vehicle is secured with the electric parking brake.
- Active Distance Assist DISTRONIC is ended.
- The vehicle is unlocked.
- If possible, an emergency call is placed to the Mercedes-Benz emergency call center.

The driver can cancel the deceleration at any time by performing one of the following actions:

- Steering

- Braking or accelerating
- Deactivating Active Distance Assist DISTRONIC

### Active Lane Change Assist

#### Function of Active Lane Change Assist



Active Lane Change Assist supports the driver when changing lanes by applying steering torque if the driver activates a turn signal indicator.

Observe the notes on driving systems and your responsibility; you may otherwise fail to recognize dangers (→ page 162).

Assistance when changing lanes is provided if all the following conditions are met:

- You are driving on a freeway or road with multiple lanes in the direction of travel.
- The neighboring lane is separated by a broken lane marking.
- No vehicle is detected in the adjacent lane.
- The vehicle speed is between 50 mph (80 km/h) and 110 mph (180 km/h).

- Active Lane Change Assist is switched on in the multimedia system.
- Active Steering Assist is activated and active.

If no vehicle is detected in the adjacent lane and a lane change is permitted, the lane change begins after the driver has activated the turn signal indicator. This is shown to the driver with a green arrow next to the  steering wheel symbol. The **Lane Change to the Left** message, for example, also appears. If Active Lane Change Assist has been activated with the turn signal indicator but a lane change is not immediately possible, a gray arrow appears next to the  steering wheel symbol, which remains green.

When lane change assistance starts, the turn signal indicator is automatically activated along with the display in the Instrument Display.

If a lane change is not possible, the arrow is faded out after a few seconds and a new lane change must be initiated. An immediate lane change is only possible on freeway sections without speed limits.

If the system is impaired, Active Lane Change Assist may be canceled. If it is canceled, the

**Lane Change Canceled** message appears in the Instrument Display.

In addition, a warning tone may sound, depending on the situation.

**⚠ WARNING** Risk of accident when changing lane to an occupied adjacent lane

Lane Change Assist cannot always clearly detect if the adjacent lane is free.

The lane change might be initiated although the adjacent lane is not free.

- ▶ Before changing lanes, make sure that the neighboring lane is free and there is no danger to other road users.
- ▶ Monitor the lane change.

**⚠ WARNING** Risk of accident if Lane Change Assist unexpectedly stops functioning

If the system limitations for Lane Change Assist have been reached, there is no guarantee that the system will remain active.

Lane Change Assist cannot then assist you by applying steering torque.

- ▶ Always monitor the lane change and keep your hands on the steering wheel. Observe the traffic conditions and steer and/or brake if necessary.

### System limits

The system limitations of Active Steering Assist apply to Active Lane Change Assist (→ page 179).

The system may also be impaired or may not function in the following situations:

- The sensors in the rear bumper are dirty, damaged or covered by a sticker or ice and snow, for example.
  - The exterior lighting shows a malfunction.
- i** The Active Lane Change Assist sensors adjust automatically while a certain distance is being driven after the vehicle has been delivered. Active Lane Change Assist is unavailable or only partially available during this teach-in process; no arrow appears next to the  Active Steering Assist symbol when the turn signal indicator is activated.

### Selecting Active Lane Change Assist

Multimedia system:

-  ▶ Settings ▶ Assistance
- ▶▶ Active Lane Change Assist

- ▶ Select the function.

### Active Brake Assist

#### Function of Active Brake Assist

Active Brake Assist consists of the following functions:

- Distance warning function
- Autonomous braking function
- Situation-dependent braking assistance
- **Vehicles with Driving Assistance Package:** Evasive Steering Assist and cornering function

Active Brake Assist can help you to minimize the risk of a collision with vehicles, cyclists or pedestrians or to reduce the effects of such a collision.

If Active Brake Assist has detected a risk of collision, a warning tone sounds and the  dis-

tance warning lamp lights up in the instrument cluster.

**Vehicles with PRE-SAFE®:** depending on the country, an additional haptic warning occurs in the form of slight, repeated tensioning of the seat belt.

If you do not react to the warning, autonomous braking can be initiated in critical situations.

In especially critical situations, Active Brake Assist can initiate autonomous braking directly. In this case, the warning lamp and warning tone occur simultaneously with the braking application.

If you apply the brake yourself in a critical situation or apply the brake during autonomous braking, situation-dependent braking assistance occurs. The brake pressure increases up to maximum full-stop braking if necessary.

Observe the notes on driving systems and your responsibility; you may otherwise fail to recognize dangers (→ page 162).

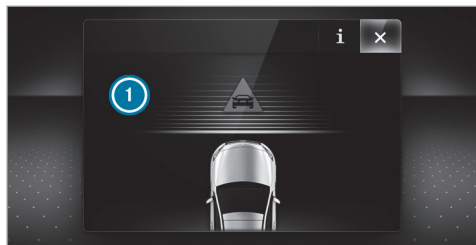

If autonomous braking or situation-dependent braking assistance has occurred, display ① appears in the Instrument Display and then automatically goes out after a short time.

If the autonomous braking function or the situation-dependent braking assistance is triggered, additional preventive measures for occupant protection (PRE-SAFE®) may also be initiated.

**⚠ WARNING** Risk of an accident caused by limited detection performance of Active Brake Assist

Active Brake Assist cannot always clearly identify objects and complex traffic situations.

In such cases, Active Brake Assist might:

- Give a warning or brake without reason
- Not give a warning or not brake

Active Brake Assist is only an aid. The driver is responsible for maintaining a sufficiently safe distance to the vehicle in front, vehicle speed and for braking in good time.

- ▶ Always pay careful attention to the traffic situation; do not rely on Active Brake Assist alone.
- ▶ Be prepared to brake or swerve if necessary.

Also observe the system limits of Active Brake Assist.

#### The individual subfunctions are available in various speed ranges:

The distance warning function can issue a warning in the following situations:

- From approximately 4 mph (7 km/h), if your vehicle is critically close to a vehicle, cyclist or pedestrian, you will hear an intermittent warn-

ing tone and the  distance warning lamp lights up in the instrument cluster.

**Vehicles with PRE-SAFE®:** depending on the country, an additional haptic warning occurs in the form of slight, repeated tensioning of the seat belt.

Brake immediately or take evasive action, provided it is safe to do so and the traffic situation allows this.

#### Distance warning function (vehicles without Driving Assistance Package)

The distance warning function can aid you in the following situations with an intermittent warning tone and a warning lamp:

- at speeds up to approximately 155 mph (250 km/h) when approaching vehicles ahead
- at speeds up to approximately 50 mph (80 km/h) when approaching stationary vehicles, pedestrians walking in the direction of travel and cyclists ahead
- at speeds up to approximately 37 mph (60 km/h) when approaching crossing pedestrians

**Distance warning function (vehicles with Driving Assistance Package)**

The distance warning function can aid you in the following situations with an intermittent warning tone and a warning lamp:

- at speeds up to approximately 155 mph (250 km/h) when approaching vehicles ahead
- at speeds up to approximately 62 mph (100 km/h) when approaching stationary vehicles
- at speeds up to approximately 50 mph (80 km/h) when approaching moving pedestrians and cyclists ahead
- at speeds up to approximately 43 mph (70 km/h) when approaching stationary pedestrians, crossing vehicles and stationary and crossing cyclists

**Autonomous braking function (vehicles without Driving Assistance Package)**

If the vehicle is traveling at speeds above approximately 4 mph (7 km/h), the autonomous braking function may intervene in the following situations:

- at speeds up to approximately 124 mph (200 km/h) when approaching vehicles ahead
- at speeds up to approximately 50 mph (80 km/h) when approaching cyclists ahead
- at speeds up to approximately 37 mph (60 km/h) when approaching stationary vehicles or moving pedestrians

**Autonomous braking function (vehicles with Driving Assistance Package)**

If the vehicle is traveling at speeds above approximately 4 mph (7 km/h), the autonomous braking function may intervene in the following situations:

- at speeds up to approximately 155 mph (250 km/h) when approaching vehicles ahead
- at speeds up to approximately 62 mph (100 km/h) when approaching stationary vehicles

- at speeds up to approximately 50 mph (80 km/h) when approaching cyclists ahead
- at speeds up to approximately 43 mph (70 km/h) when approaching stationary and moving pedestrians, crossing vehicles and stationary and crossing cyclists

**Situation-dependent braking assistance (vehicles without Driving Assistance Package)**

The situation-dependent braking assistance can intervene from a speed of approximately 4 mph (7 km/h) in the following situations:

- at speeds up to approximately 155 mph (250 km/h) when approaching vehicles ahead
- at speeds up to approximately 50 mph (80 km/h) when approaching stationary vehicles and vehicles ahead
- at speeds up to approximately 37 mph (60 km/h) when approaching moving pedestrians

### **Situation-dependent braking assistance (vehicles with Driving Assistance Package)**

The situation-dependent braking assistance can intervene from a speed of approximately 4 mph (7 km/h) in the following situations:

- at speeds up to approximately 155 mph (250 km/h) when approaching vehicles ahead
- at speeds up to approximately 62 mph (100 km/h) when approaching stationary vehicles
- at speeds up to approximately 50 mph (80 km/h) when approaching cyclists ahead
- at speeds up to approximately 37 mph (60 km/h) when approaching stationary and moving pedestrians, crossing vehicles, and stationary and crossing cyclists

### **Canceling a brake application of Active Brake Assist**

You can cancel a brake application of Active Brake Assist at any time by:

- sharply depressing the accelerator pedal or with kickdown
- releasing the brake pedal

Active Brake Assist may cancel the brake application when one of the following conditions is fulfilled:

- You maneuver to avoid the obstacle
- There is no longer a risk of collision
- An obstacle is no longer detected in front of your vehicle

### **Evasive Steering Assist (only vehicles with Driving Assistance Package)**

Evasive Steering Assist has the following characteristics:

- The ability to detect stationary or moving pedestrians.
- Assistance through power-assisted steering if it detects a swerving maneuver.
- Activation by an abrupt steering movement during a swerving maneuver.
- Assistance during swerving and straightening of the vehicle.
- Reaction from a speed of approximately 12 mph (20 km/h) up to a speed of approximately 43 mph (70 km/h).

You can prevent the assistance at any time by actively steering.

### **Cornering function (only vehicles with Driving Assistance Package)**

If the system detects a risk of a collision with an oncoming vehicle when turning across an oncoming lane, autonomous braking can be initiated at speeds below 9 mph (15 km/h) before you have left the lane in which you are driving.

#### **⚠ WARNING Risk of accident despite Evasive Steering Assist**

Evasive Steering Assist cannot always recognize objects or complex traffic situations clearly.

Moreover, the steering support provided by Evasive Steering Assist is not sufficient to avoid a collision.

- ▶ Always pay careful attention to the traffic situation; do not rely on Evasive Steering Assist alone.
- ▶ Be prepared to brake or swerve if necessary.

- ▶ End the support by actively steering in non-critical situations.
- ▶ Drive at an appropriate speed if there are pedestrians close to the path of your vehicle.

### System limits

Full system performance is not yet available for a few seconds after switching on the vehicle or after driving off.

If Active Brake Assist is impaired or inoperative due to a malfunction, the  warning lamp appears in the Instrument Display.

The system may be impaired or may not function, particularly in the following situations:

- In snow, rain, fog, heavy spray, if there is glare, in direct sunlight or in greatly varying ambient light.
- If the sensors are dirty, fogged up, damaged or covered.
- If the sensors are impaired due to interference from other radar sources, e.g. strong radar reflections in a parking garage.

- If a loss of tire pressure or a malfunctioning tire has been detected and displayed.
  - In complex traffic situations where objects cannot always be clearly identified.
  - If pedestrians or vehicles move quickly into the sensor detection range.
  - If pedestrians are hidden by other objects.
  - If the typical outline of a pedestrian cannot be distinguished from the background.
  - If a pedestrian is not detected as such, e.g. due to special clothing or other objects.
  - If the driver's seat belt is not fastened.
  - On curves with a tight radius.
-  The Active Brake Assist sensors adjust automatically while a certain distance is being driven after the vehicle has been delivered. Active Brake Assist is unavailable or only partially available during the teach-in process.

### Activating/deactivating Active Brake Assist

#### Requirements:



- The vehicle is switched on.

Multimedia system:

  **▶▶ Settings ▶▶ Assistance**  
**▶▶ Active Brake Assist**

- ▶ Select the desired setting.  
The setting is retained when the drive system is next started.

### Deactivating Active Brake Assist

-  It is recommended that you always leave Active Brake Assist activated.
- ▶ Select **Off**.  
The distance warning function, the autonomous braking function and Evasive Steering Assist are deactivated.  
When the vehicle is next started, the middle setting is automatically selected.
-  If Active Brake Assist is deactivated, the  symbol appears in the status bar of the Instrument Display.

## Traffic Sign Assist

### Function of Traffic Sign Assist

Traffic Sign Assist detects traffic signs with the multifunction camera (→ page 163). It assists you by displaying detected speed limits and overtaking restrictions in the Instrument Display.

Observe the notes on driving systems and your responsibility; you may otherwise fail to recognize dangers (→ page 162).

Since Traffic Sign Assist also uses the data stored in the navigation system, it can update the display in the following situations without detecting traffic signs.

The camera also detects traffic signs with a restriction indicated by an additional sign (e.g. when wet). These are only displayed if a restriction applies or if the system cannot clearly determine whether the restriction applies.

### Warning when the maximum permissible speed is exceeded

The system can warn you if you unintentionally exceed the maximum permissible speed. To do this, you can specify in the multimedia system by how much the maximum permissible speed can

be exceeded before a warning is issued. You can specify whether the warning is to be just a visual warning or an acoustic one as well.

### Display in the Instrument Display

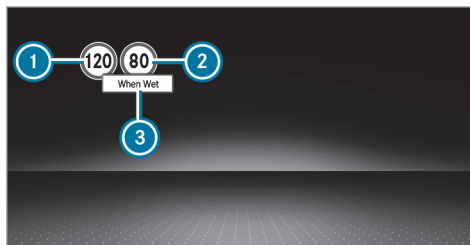

Instrument Display in the Widescreen Cockpit

- ① Maximum permissible speed
  - ② Maximum permissible speed when there is a restriction
  - ③ Additional sign with restriction
- ⓘ **Vehicles with a standard Instrument Display:** A + symbol next to a traffic sign in the Instrument Display indicates that additional traffic signs have been detected. These can also be

displayed in the media display and optionally in the Head-up Display.

If Traffic Sign Assist cannot determine the maximum permissible speed (e.g. due to missing signs), the following display appears in the Instrument Display:



This is displayed continuously if the vehicle is in a country where Traffic Sign Assist is not supported. Traffic Sign Assist is not available in all countries.

- ⓘ Also observe the information on display messages in Traffic Sign Assist (→ page 345).

### System limits

The system may be impaired or may not function particularly in the following situations:

- If there is poor visibility, e.g. due to insufficient illumination of the road, highly variable shade conditions, rain, snow, fog or heavy spray.
- If there is glare, e.g. from oncoming traffic, direct sunlight or reflections.



- If the windshield in the area of the multifunction camera is dirty, or if the camera is fogged up, damaged or covered.
- If the traffic signs are hard to detect, e.g. due to dirt, snow or insufficient lighting, or because they are covered.
- If the information in the navigation system's digital map is incorrect or out-of-date.
- If signs are ambiguous, e.g. road signs in roadworks or in adjacent lanes.
- If you turn sharply when passing traffic signs outside the camera's field of vision.

### Setting Traffic Sign Assist

#### Requirements:

- **Only vehicles with Driving Assistance Package:**  
Active Distance Assist DISTRONIC and ECO Assist must be activated for the automatic adoption of speed limits.

Multimedia system:

→  ▶ Settings ▶ Assistance  
▶ Traffic Sign Assist

### Activating or deactivating automatic adoption of speed limits (only vehicles with Driving Assistance Package)

- ▶ Select **Limit Adoption**.
- ▶ Switch the function on or off.  
The speed limits detected by Traffic Sign Assist are automatically adopted by Active Distance Assist DISTRONIC.

 If one of the following systems is activated, the detected speed can be manually adopted as the speed limit:

- Active Distance Assist DISTRONIC
- Cruise control
- Variable limiter

Further information about Active Distance Assist DISTRONIC: (→ page 174).

### Displaying detected traffic signs in the media display

- ▶ Select **Display in Central Display**.
- ▶ Switch the function on or off.

### Setting the type of warning

- ▶ Select **Visual & Audible**, **Visual** or **Off**.

### Setting the warning threshold

This value determines the speed at which a warning is issued when exceeded.

- ▶ Select **Warning Threshold**.
- ▶ Set the desired speed.

### Traffic Light Information service

 **WARNING** Risk of an accident or injury due to distraction, incorrect or missing data

The traffic light information display is an aid and cannot replace the observation of the actual driving situation.

- ▶ Keep the actual traffic situation constantly in view when approaching a traffic light and when changing lanes.
- ▶ Avoid looking at the Instrument Display and Head-up Display for a long time.

The Instrument Display and Head-up Display (if available) show the traffic light icon and remaining time 1 until the next green phase as a countdown.



Example representation in the Instrument Display

The display is hidden about five seconds before the traffic lights change to green.

- ❗ The display also goes out in the following cases:
  - When turning off before the intersection into a cross or side street
  - When turning before the intersection
- ❗ The direction arrows are displayed depending on the following functions:
  - A turn signal is set
  - A lane is recommended during active route guidance

If neither function is active, the remaining time until the next green phase for the lane straight ahead is displayed.

- ❗ Use of the traffic light information service requires the regular transmission of vehicle positions and driving directions to Mercedes-Benz. The data is immediately anonymized by Mercedes-Benz and forwarded to the provider of the traffic light information service. The vehicle positions and driving directions are deleted after a very short time (a few seconds) and are not permanently saved.

If you do not want to transmit the vehicle positions and driving directions, you have the following options:

- You deactivate the service in the Mercedes me portal.
- You have the service deactivated at an authorized Mercedes-Benz Center.
- You deactivate the service in the **Assistance** menu in the multimedia system (→ page 191).

- ❗ This traffic light information service is only available in certain cities and regions.

The function is supported under the following conditions:

- The vehicle is equipped with a multimedia system featuring navigation and a communication module with an activated, integrated SIM card.
- You have a user account for the Mercedes me Portal.
- The vehicle has been connected with the user account.

- The navigation services option is available, subscribed to and activated in the Mercedes me Portal.
- The traffic light data service belongs to the scope of the navigation services.

The current vehicle position and the direction of travel are transmitted via the communication module and aligned with the data from the traffic light data service provider. The provider gathers data from traffic lights which transmit their changing phases. When the vehicle approaches an intersection with networked traffic lights, data is transmitted to the vehicle.

A set turn signal left or right and lane recommendations during active route guidance are taken into account for the display.

The service is for information purposes only and is not linked to any other vehicle functions, systems or components. Please note that the displayed data is not available in all traffic areas and may be incorrect.

Certain light signal systems automatically adapt their switching times to the current traffic situa-

tion. This can lead to a sudden change in the countdown display.

The information in the Instrument Display is shown after selecting the display contents in the **Assistance** menu. If another menu is selected, the traffic light countdown is not displayed.

Also observe the following information:

- select a speed adapted to the traffic, surroundings and weather conditions
- observe actual traffic signs
- observe applicable traffic rules and regulations

Please observe the notes on driving systems and your responsibility. You could otherwise fail to recognize dangers.

### System limits

The display does not appear in the following situations, for example:



- There is no traffic light data available.
- The time remaining until the next green phase is less than ten seconds.

- Emergency vehicles or local public transport are located in the vicinity of the intersection.
- The data transmission from the vehicle has been interrupted.
- The traffic light systems are located in a construction site area or are undergoing maintenance.
- The light signal system is malfunctioning.
- The subscription to the service has expired.

### Switching the traffic light information display on or off

Multimedia system:

  **» Settings » Assistance**

 Switch **Traffic Light Information** on  or off .



## Blind Spot Assist and Active Blind Spot Assist with exit warning

### Function of Blind Spot Assist and Active Blind Spot Assist with exit warning

Blind Spot Assist and Active Blind Spot Assist use two lateral, rear-facing radar sensors to monitor the area up to 130 ft (40 m) behind and 10 ft (3 m) next to your vehicle.

If a vehicle is detected at speeds above approximately 8 mph (12 km/h) and this vehicle subsequently enters the monitoring range directly next to your vehicle, the warning lamp in the outside mirror lights up red.

Permanent status display in the instrument cluster:

-  (gray): system is activated but inoperative
-  (green): system is activated and operational

If a vehicle is detected close to your vehicle and you switch on the turn signal indicator in the corresponding direction, a double warning tone sounds and the red warning lamp in the outside

mirror flashes. If the turn signal indicator remains switched on, all other detected vehicles are indicated only by the flashing of the red warning lamp.

If you overtake a vehicle quickly, no warning is given.

#### **WARNING** Risk of accident despite Blind Spot Assist

Blind Spot Assist does not react to vehicles approaching and overtaking you at a greatly different speed.

Blind Spot Assist cannot warn drivers in this situation.

- ▶ Always pay careful attention to the traffic situation and maintain a safe distance at the side of the vehicle.

Observe the notes on driving systems and your responsibility; you may otherwise fail to recognize dangers (→ page 162).

#### Exit warning

The exit warning is an additional function of Blind Spot Assist and can warn vehicle occupants about

approaching vehicles when leaving the vehicle when stationary.

#### **WARNING** Risk of accident despite exit warning

The exit warning neither reacts to stationary objects nor to persons or road users approaching you at a greatly differing speed.

The exit warning cannot warn drivers in these situations.

- ▶ Always pay particular attention to the traffic situation when opening the doors and make sure there is sufficient clearance.

If there is a vehicle in the monitoring range, this is indicated in the outside mirror. If a vehicle occupant opens the door on the side with the warning, a warning tone sounds and the warning lamp in the outside mirror starts to flash.

This additional function is only available when Blind Spot Assist is active. When the exit warning is activated, it can warn vehicle occupants for up to three minutes after switching the vehicle off.

The exit warning is no longer available once the warning lamp in the outside mirror flashes three times.

The exit warning is only an aid and not a substitute for the attention of vehicle occupants. The responsibility for opening and closing the doors and for leaving the vehicle remains with the vehicle occupants.

### System limits

Blind Spot Assist and Active Blind Spot Assist may be limited in the following situations, in particular:

- if there is dirt on the sensors or the sensors are obscured
- in poor visibility, e.g. due to fog, heavy rain or snow
- if there are narrow vehicles, e.g. bicycles or motorbikes
- if the road has very wide or narrow lanes
- if vehicles are not driving in the middle of their lane

Warnings may be issued in error when driving close to crash barriers or similar continuous lane

borders. Always make sure that there is sufficient distance to the side for other traffic or obstacles.

Warnings may be interrupted when driving alongside long vehicles, for example trucks, for a prolonged time.

Blind Spot Assist is not operational when reverse gear is engaged.

The exit warning may be limited in the following situations:

- when the sensors are covered by adjacent vehicles in narrow parking spaces
- when people approach the vehicle
- in the event of stationary or slowly moving objects

### Function of brake application (Active Blind Spot Assist)

If Active Blind Spot Assist detects a risk of a side impact in the monitoring range, a course-correcting brake application is carried out. This is designed to help you avoid a collision.

The course-correcting brake application is available in the speed range between approximately 20 mph (30 km/h) and 125 mph (200 km/h).

### **⚠ WARNING** Risk of accident despite brake application of Active Blind Spot Assist

A course-correcting brake application cannot always prevent a collision.

- ▶ Always steer, brake or accelerate yourself, especially if Active Blind Spot Assist warns you or makes a course-correcting brake application.
- ▶ Always maintain a safe distance at the sides.



If a course-correcting brake application occurs, the red warning lamp flashes in the outside mirror and a warning tone sounds. In addition, display

① indicating the danger of a side collision appears in the Instrument Display.

In rare cases, the system may make an inappropriate brake application. This brake application may be interrupted at any time if you steer slightly in the opposite direction or accelerate.

### System limits

Note the system limitations of Active Blind Spot Assist; you may otherwise not recognize the dangers (→ page 192).

Either a course-correcting brake application appropriate to the driving situation, or none at all, may occur in the following situations:

- Vehicles or obstacles, e.g. crash barriers, are located on both sides of your vehicle.
- A vehicle approaches too closely on the side.
- You have adopted a sporty driving style with high cornering speeds.
- You brake or accelerate significantly.
- A driving safety system intervenes, e.g. ESP® or Active Brake Assist.
- ESP® is deactivated.

- A loss of tire pressure or a malfunctioning tire is detected.

### Activating/deactivating Blind Spot Assist or Active Blind Spot Assist

Multimedia system:

→  » Settings » Assistance

▶ Activate or deactivate **Blind Spot Assist**.

or

▶ Activate or deactivate **Act. Blind Spot Assist**.

### Active Lane Keeping Assist



#### Function of Active Lane Keeping Assist

Active Lane Keeping Assist monitors the area in front of your vehicle by means of the multifunction camera (→ page 163). It serves to protect you against unintentionally leaving your lane. You will be warned by vibration pulses in the steering wheel and guided by a course-correcting brake application back into your lane.

Active Lane Keeping Assist is available in the speed range between 37 mph (60 km/h) and 124 mph (200 km/h).

Active Lane Keeping Assist can neither reduce the risk of an accident if you fail to adapt your driving style nor override the laws of physics. It cannot take into account road, weather or traffic conditions. Active Lane Keeping Assist is only an aid. You are responsible for maintaining a safe distance to the vehicle in front, for vehicle speed, for braking in good time and for staying in lane.

The status of Active Lane Keeping Assist is displayed in the on-board computer:

-  (green): Active Lane Keeping Assist is active and operating.
-  (gray): Active Lane Keeping Assist is active but not operating.
- : Active Lane Keeping Assist is deactivated or there is a malfunction.

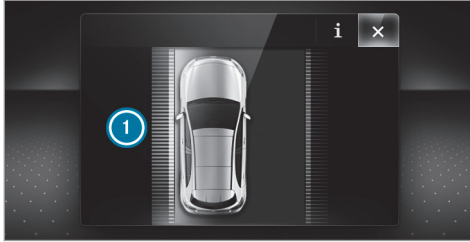

If a lane-correcting brake application occurs, display ❶ appears in the Instrument Display.

The system does not apply the brake if you activate the turn signal indicator.

**Vehicles with Driving Assistance Package:** if the system detects an obstacle, such as another vehicle in the adjacent lane, it will apply the brake regardless of the turn signal indicator.

You are warned by vibrations in the steering wheel in the following circumstances:

- Active Lane Keeping Assist detects a lane marking.
- A front wheel drives over this lane marking.

#### Conditions for a course-correcting brake application (vehicles without Driving Assistance Package)

Lane markings were detected on both sides of the lane. The front wheel drives over a continuous lane marking.

- ❶ A brake application may be interrupted at any time if you steer slightly in the opposite direction.

#### Conditions for a course-correcting brake application (vehicles with Driving Assistance Package)

- A continuous lane marking was detected and driven over with the front wheel.
- A lane marking and an approaching vehicle, an overtaking vehicle or vehicles driving parallel to your vehicle were detected in the adjacent lane. The front wheel drives over the lane marking.
- ❶ A brake application may be interrupted at any time if you steer slightly in the opposite direction.

#### System limits

No lane-correcting brake application occurs in the following situations:

- You clearly and actively steer, brake or accelerate.
- If a driving safety system intervenes, such as ESP®, Active Brake Assist or Active Blind Spot Assist.
- You have adopted a sporty driving style with high cornering speeds or high rates of acceleration.
- When ESP® is deactivated.
- If a loss of tire pressure or a faulty tire is detected and displayed.

If you deactivate the Active Lane Keeping Assist warning and the lane markings cannot be clearly detected, it is possible that no lane-correcting brake application takes place (→ page 196).



The system may be impaired or may not function particularly in the following situations:

- If there is poor visibility, e.g. due to insufficient illumination of the road, highly variable shade conditions, rain, snow, fog or heavy spray.
- If there is glare, e.g. from oncoming traffic, the sun or reflections.
- If the windshield in the area of the multifunction camera is dirty, or if the camera is fogged up, damaged or covered.
- If there are no lane markings, or several unclear lane markings are present for one lane, e.g. around roadworks.
- If the lane markings are worn, dark or covered.
- If the distance to the vehicle in front is too short and thus the lane markings cannot be detected.
- If the lane markings change quickly, e.g. lanes branch off, cross one another or merge.
- If the road is very narrow and winding.
- **Vehicles with Driving Assistance Package:** if the radar sensors in the rear bumper are dirty

or covered in snow and an obstacle is detected in your lane, no lane-correcting brake application takes place.

### Activating/deactivating Active Lane Keeping Assist

Multimedia system:

  **» Settings » Quick Access  
» Active Lane Keeping Assist**

 Switch the function on or off.

### Setting Active Lane Keeping Assist

Multimedia system:

  **» Settings » Assistance  
» Active Lane Keeping Assist**

### Activating or deactivating the haptic warning

 Select **Warning**.  
Activate or deactivate the function.

### DYNAMIC BODY CONTROL function

DYNAMIC BODY CONTROL continuously adjusts the characteristics of the suspension dampers to the current operating and driving conditions.



The damping is tuned individually for each wheel and is affected by the following factors:

- The road surface conditions
- Vehicle load
- The drive program selected
- The driving style

The drive program can be adjusted using the DYNAMIC SELECT switch.

### AIR BODY CONTROL

#### AIR BODY CONTROL function

 <b>NOTE</b> Mercedes-AMG vehicles
 Observe the notes in the Supplement. You could otherwise fail to recognize dangers.

AIR BODY CONTROL is an air suspension system with variable damping for improved driving comfort. The all-round level control system ensures the best possible suspension and constant ground clearance, even with a laden vehicle. When driving



at speed, the vehicle is lowered automatically to improve driving safety and to reduce fuel consumption. You also have the option of manually adjusting the vehicle level.

AIR BODY CONTROL includes the following components and functions:

- Air suspension with variable spring rate
- Automatic level control system
- Speed-dependent lowering to reduce fuel consumption
- Manually selectable high-level setting for greater ground clearance
- ADS PLUS (Adaptive Damping System with constant damping force adjustment)
- DYNAMIC SELECT switch and level button

### Suspension setting and vehicle level per drive program

Drive program **[C]**:

- The suspension setting is comfortable.
- The vehicle is set to the normal level.

- When driving at speeds of approximately 78 mph (125 km/h) or above, the vehicle is lowered.
- When driving at speeds below approximately 50 mph (80 km/h), the vehicle is raised again.

Drive program **[E]**:

- The suspension setting is comfortable.
- The vehicle is set to low level -1.
- The vehicle is not lowered any further if you are traveling at higher speeds.

Drive program **[S]**:

- The suspension setting is firmer.
- The vehicle is set to low level -1.
- The vehicle is not lowered any further if you are traveling at higher speeds.

Drive program **[S']**:

- The suspension setting is even firmer.
- The vehicle is set to low level -1.
- The vehicle is not lowered any further if you are traveling at higher speeds.

Individual suspension settings can be called up in drive program **[I\*]** (→ page 147).

### Setting the vehicle level

**⚠ WARNING** Risk of accident because vehicle level is too high

Driving characteristics may be impaired.

The vehicle can drift outwards, for example, when steering or cornering.

- ▶ Choose a vehicle level which is suited to the driving style and the road surface conditions.

**⚠ WARNING** Risk of entrapment from vehicle lowering

When lowering the vehicle, people could become trapped if their limbs are between the vehicle body and the tires or underneath the vehicle.

- ▶ Make sure no one is underneath the vehicle or in the immediate vicinity of the

wheel arches when the vehicle is being lowered.

**⚠ WARNING** Risk of becoming trapped due to the vehicle lowering

**Vehicles with AIR BODY CONTROL or level control system:** when you unload luggage or leave the vehicle, the vehicle first rises slightly and then returns to the set level shortly afterwards.

You or anyone else in the vicinity of the wheel arches or the underbody could thus become trapped.

The vehicle can also be lowered after being locked.

▶ When leaving the vehicle, make sure that nobody is in the vicinity of the wheel arches or the underbody.

**! NOTE** Damage due to vehicle lowering

Parts of the body could be damaged when the vehicle is lowered.

▶ Make sure that there are no obstacles such as curbs underneath or in the immediate vicinity of the body when the vehicle is being lowered.

**! NOTE** Mercedes-AMG vehicles

▶ Observe the notes in the Supplement. You could otherwise fail to recognize dangers.

#### Requirements:

- The vehicle has been started.
- The vehicle must not be moving faster than 37 mph (60 km/h).

#### Raising the vehicle

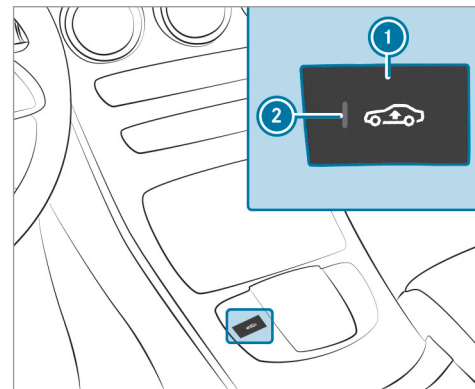

- ▶ Press button ①.  
Indicator lamp ② lights up.  
The vehicle is set to the high level.  
Your selection is saved.

The vehicle is automatically lowered again in the following situations:

- When driving faster than 50 mph (80 km/h).

- When driving between 37 mph (60 km/h) and 50 mph (80 km/h) for approximately three minutes.
- After changing a drive program using the DYNAMIC SELECT switch.

The vehicle is adjusted to the height of the last active drive program.

### Lowering the vehicle

- ▶ Press button ①.
- Indicator lamp ② goes out. The vehicle is adjusted to the height of the active drive program.

### Rear view camera

#### Function of the rear view camera

When you engage reverse gear, the image from the rear view camera is shown on the media display. Dynamic guide lines show the path the vehicle will take with the current steering angle. This helps you to orient yourself and to avoid obstacles when backing up.

The rear view camera is only an aid. It is not a substitute for your attention to the surroundings. The responsibility for safe maneuvering and parking remains with you. Make sure that there are no persons, animals or objects etc., in the maneuvering area while maneuvering and parking.

The guide lines on the media display show the distances to your vehicle. The distances displayed only apply to road level.

Depending on the vehicle equipment, you can select from the following views:

- Normal view
- Wide-angle view

The area behind the vehicle is displayed as a mirror image, as in the inside rearview mirror.

#### Vehicles without Parking Assist PARKTRONIC

The following camera views are available in the multimedia system:

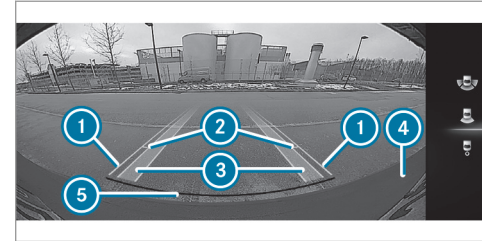

#### Normal view

- ① Driven surface depending on the current steering angle (dynamic)
- ② Guide lines at a distance of approximately 1.6 ft (0.5 m), 3.3 ft (1.0 m), 5 ft (1.5 m) and 9.9 ft (3.0 m) from the rear area
- ③ Lane marking the course the tires will take with the current steering angle (dynamic)
- ④ Bumper
- ⑤ Guide line at a distance of approximately 1.0 ft (0.3 m) from the rear area

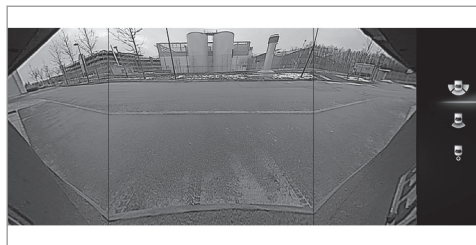

Wide-angle view

### Vehicles with Parking Assist PARKTRONIC

The following camera views are available in the multimedia system:

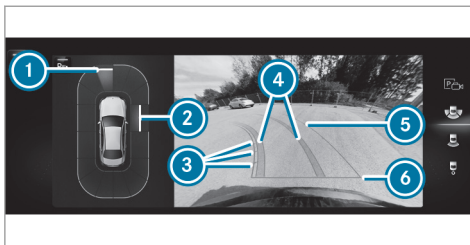

Normal view

- ① Yellow warning display: obstacles at a distance between approximately 2.3 ft (0.7 m) and 3.3 ft (1.0 m)
- ② Orange warning display: obstacles at a distance between approximately 1.3 ft (0.4 m) and 2.3 ft (0.7 m)
- ③ Guide lines at a distance of approximately 1.6 ft (0.5 m), 3.3 ft (1.0 m), 5 ft (1.5 m) and 9.9 ft (3.0 m) from the rear area
- ④ Yellow lanes marking the course the tires will take with the current steering angle (dynamic)

- ⑤ Driven surface depending on the current steering angle (dynamic)
- ⑥ Guide line at a distance of approximately 1.0 ft (0.3 m) from the rear area

The color of warning display ① / ② changes dynamically and is based on the distance to the detected obstacle:

- **Blue:** no obstacles detected at a distance less than 3.3 ft (1.0 m)
  - **Yellow:** obstacles at a distance between approximately 2.3 ft (0.7 m) and 3.3 ft (1.0 m)
  - **Orange:** obstacles at a distance between approximately 1.3 ft (0.4 m) and 2.3 ft (0.7 m)
  - **Red:** obstacles at a very short distance of approximately 1.3 ft (0.4 m) or less
- ① **Vehicles with Active Parking Assist:** when Active Parking Assist is active, lane markings ④ are displayed in green.



Wide-angle view

- 1 Display of Parking Assist PARKTRONIC

### System malfunction

If the rear view camera is not operational, the **System Inoperative** message appears on the media display.

### System limits

The rear view camera will not function or will only partially function in the following situations:

- The trunk lid is open.
- The weather conditions are poor, e.g. heavy rain, snow, fog, storm or spray.

- The ambient light conditions are poor, e.g. at night.
  - Cameras, or vehicle components in which the cameras are installed, are damaged, dirty or covered. Observe the information on vehicle sensors and cameras (→ page 163).
- 1 Do not use the rear view camera in these types of situations. You could otherwise injure others or collide with objects when parking the vehicle.
  - 1 The contrast of the display may be impaired by direct sunlight or by other light sources, e.g. when driving out of a garage. In this case, pay particular attention.
  - 1 Have the display repaired or replaced if, for example, pixel errors considerably restrict its use.

### 360° camera

#### Function of the surround view camera

The surround view camera is a system that consists of four cameras which cover the immediate surroundings of the vehicle. The system assists

you when you are parking or at exits with reduced visibility, for example.

The views of the surround view camera are always available when driving forwards up to a speed of approx. 10 mph (16 km/h) and when backing up.

The surround view camera is only an aid and may show a distorted view of obstacles, show them incorrectly or not show them at all. It is not a substitute for your attention to the surroundings. The responsibility for safe maneuvering and parking remains with you. Make sure that there are no persons, animals or objects etc., in the maneuvering area while maneuvering and parking.

The system evaluates images from the following cameras:

- Rear view camera
- Front camera
- Two side cameras in the outside mirrors

## Views of the surround view camera

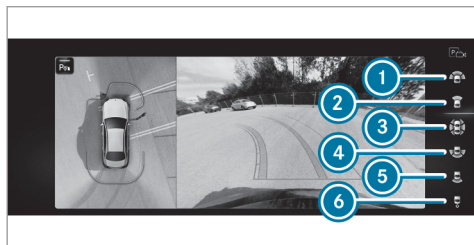

- ① Wide-angle view, front
- ② Top view with image from the front camera
- ③ Top view with images from the side cameras in the outside mirrors
- ④ Wide-angle view, rear
- ⑤ Top view with image from the rear view camera
- ⑥ Top view with trailer view (vehicles with a trailer hitch)

## Function of the guide lines

Guide lines are also displayed in the camera images of the top views. These are based on the

current steering angle and show the distance to objects and other vehicles.

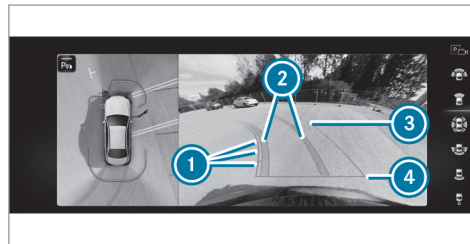

- ① Guide lines at a distance of approximately 1.6 ft (0.5 m), 3.3 ft (1.0 m), 5 ft (1.5 m) and 9.9 ft (3.0 m) from the rear area
  - ② Yellow lanes marking the course the tires will take with the current steering angle (dynamic)
  - ③ Driven surface depending on the current steering angle (dynamic)
  - ④ Guide line at a distance of approximately 1.0 ft (0.3 m) from the rear area
- ① When Active Parking Assist is active, paths ② are displayed in green.

The guide lines show the distances to your vehicle. The distances apply to road level.

In all views, the Parking Assist PARKTRONIC warning display is also shown (→ page 204).

The color of warning display changes dynamically and is based on the distance to the detected obstacle:

- **Blue:** no obstacles detected at a distance less than 3.3 ft (1.0 m)
  - **Yellow:** obstacles at a distance between approximately 2.3 ft (0.7 m) and 3.3 ft (1.0 m)
  - **Orange:** obstacles at a distance between approximately 1.3 ft (0.4 m) and 2.3 ft (0.7 m)
  - **Red:** obstacles at a very short distance of approximately 1.3 ft (0.4 m) or less
- ① When Parking Assist PARKTRONIC is operational and no object is detected, the warning display is shown here in blue.

## Wide-angle view, front



- ① Warning display of Parking Assist PARKTRONIC

## Top view with image from the front camera

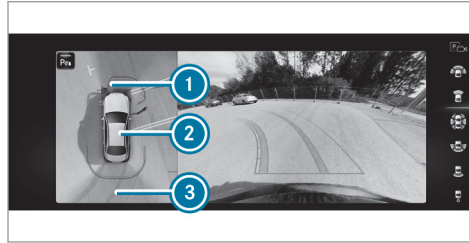

- ① Warning display of Parking Assist PARKTRONIC (→ page 204)  
 ② Your vehicle from above  
 ③ Lane indicating the route the vehicle will take at the current steering angle

**Top view with images from the side cameras in the outside mirrors**

The front and rear sides of the vehicle can be seen in this view.

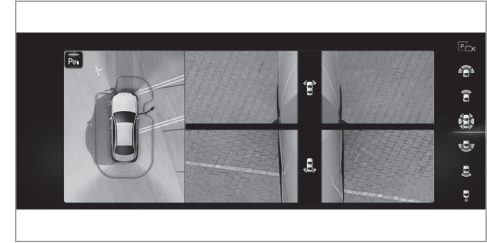
**System limits**

If the system is not ready for operation, the **System Inoperative** message appears in the media display.

The surround view camera will not function or will only partially function in the following situations:

- You are driving forwards at a speed greater than approximately 10 mph (16 km/h).
- The doors are open.
- An outside mirror is not completely folded out.
- The trunk lid is open.
- The weather conditions are poor, e.g. heavy rain, snow, fog, storm or spray.

- The ambient light conditions are poor, e.g. at night.
- The camera lens is obstructed, dirty or fogged up.
- If cameras or vehicle components in which the cameras are installed are damaged. In this event, have the cameras, their positions and their setting checked at a qualified specialist workshop.

**i** Do not use the surround view camera under such circumstances. You could otherwise injure others or collide with objects when parking the vehicle.

For technical reasons, the standard height of the vehicle may be altered if the vehicle is carrying a heavy load and can result in inaccuracies in the guide lines and in the display of the generated images.

The field of vision and other functions of the camera system may be restricted due to additional attachments on the vehicle (e.g. license plate bracket, bicycle rack).

**i** The contrast of the display may be impaired by abrupt, direct sunlight or by other light

sources, e.g. when driving out of a garage. In this case, pay particular attention.

**i** Have the display repaired or replaced if, for example, pixel errors considerably restrict its use.

See the notes on cleaning the surround view camera (→ page 277).

#### Calling up the view of the surround view camera using reverse gear

- ▶ Engage reverse gear.
- ▶ Select the desired view in the multimedia system (→ page 201).
- ▶ If, after shifting to reverse gear, the image of the rear view camera is not shown: switch off the vehicle, press and hold the  button, switch on the vehicle and engage reverse gear again.

#### Opening the camera cover of the rear view camera

Multimedia system:

 **▶ Settings ▶ Assistance**  
**▶ Camera & Parking**

 Select **Open Camera Cover**.

**i** The camera cover closes automatically after some time or after an ignition cycle.

#### Parking Assist PARKTRONIC

##### Function of Parking Assist PARKTRONIC

Parking Assist PARKTRONIC is an electronic parking assistance system which monitors the area surrounding your vehicle and shows you the distance between the vehicle and a detected obstacle visually and audibly.

Parking Assist PARKTRONIC is only an aid. It is not a substitute for your attention to the surroundings. The responsibility for safe maneuvering and parking remains with you. Make sure that there are no persons, animals or objects in the maneuvering area while maneuvering and parking in/exiting parking spaces.



The passive side impact protection also warns you of obstacles to the side. During the parking procedure or maneuvering, objects are detected as the vehicle drives past. If you steer in the direction of a detected obstacle and there is a risk of a lateral collision, a warning is issued. In order for an object on the side to be detected, the sensors in the front and rear bumper must first detect the object while you are driving past it.

In order for front or rear obstacles to the side to be displayed, the vehicle must first travel a distance of at least half a vehicle length. Once the vehicle has traveled one vehicle length, obstacles on all sides can be shown.

### Displays on the media display

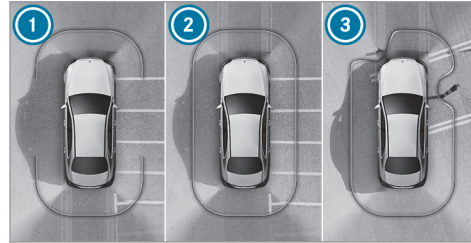

Vehicles with surround view camera

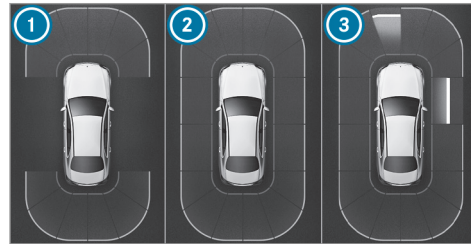

Vehicles without surround view camera

As soon as Parking Assist PARKTRONIC is operational, the respective areas of the display are shown in blue.

- ① Operational, front and rear
- ② Operational, all around
- ③ Obstacles detected at the front left and on the right-hand side

The color of the display changes depending on the distance to the detected obstacle:

- **Blue:** > 3.3 ft (1 m) (no obstacles detected)
- **Yellow:** approximately 3.3 ft (1 m) - 2.3 ft (0.7 m)
- **Orange:** approximately 2.3 ft (0.7 m) - 1.2 ft (0.4 m)
- **Red:** < 1.2 ft (0.4 m)

**Vehicles with surround view camera:** the boundary line shifts dynamically depending on the position and distance of the obstacles detected.

Depending on the distance to the obstacle detected, an intermittent warning tone also sounds. You can set the timing of the warnings in the multimedia system (→ page 210).

Standard setting:

- **Front and sides:** < 1.2 ft (0.4 m)
- **Rear:** < 3.3 ft (1 m)

**Warn Early All Around:**

- **Front:** < 3.3 ft (1 m)
- **Sides:** < 2.3 ft (0.7 m)
- **Rear:** < 3.3 ft (1 m)

A continuous warning tone sounds from a distance of approximately 0.7 ft (0.2 m), regardless of the selected setting.

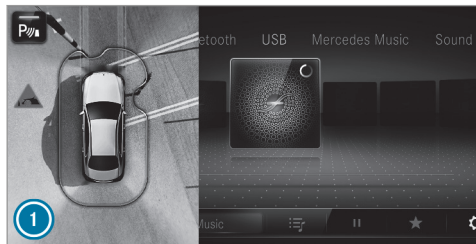

Vehicles with surround view camera

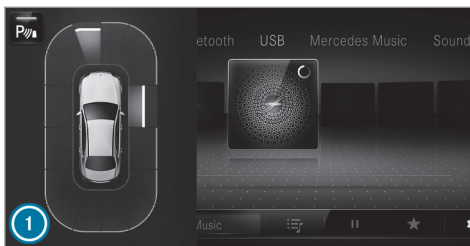

Vehicles without surround view camera

If an obstacle in the vehicle path is detected and the **Camera & Parking** menu is not open on the media display, pop-up window ① appears:

- **vehicles without Active Parking Assist:** at speeds below 8 mph (12 km/h)
- **vehicles with Active Parking Assist:** at speeds below 11 mph (18 km/h)

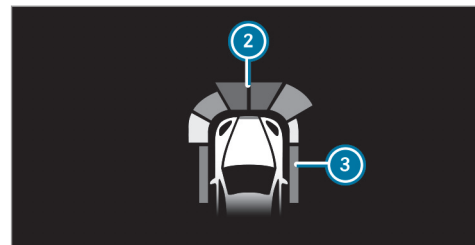

Optionally, obstacles detected by Parking Assist PARKTRONIC from a distance of approximately 3.3 ft (1.0 m) in front ② and 2.3 ft (0.7 m) on the side ③ can also be displayed in the Head-up Display.

### System limits

Parking Assist PARKTRONIC does not necessarily take into account the following obstacles:

- Obstacles below the detection range, e.g. persons, animals or objects.
- Obstacles above the detection range, e.g. overhanging loads, overhangs or loading ramps of trucks.

- Pedestrians or animals approaching the vehicle from the side.
- Objects placed next to the vehicle.

Obstacles on the sides are not shown in the following situations, for example:

- You park the vehicle and switch it off.
- You open the doors.

After an engine start, obstacles must be detected again by driving past them before a warning can be issued.

Observe the information on vehicle sensors and cameras; the system otherwise cannot function properly (→ page 163).

### Problems with Parking Assist PARKTRONIC

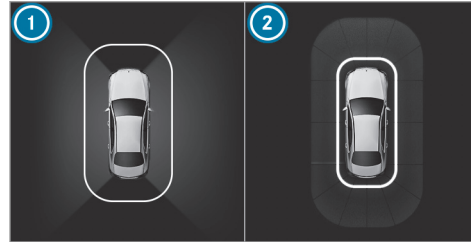

- ① Vehicles with surround view camera
- ② Vehicles without surround view camera

If the Parking Assist PARKTRONIC display lights up red for approximately three seconds then goes out, and the  symbol appears in the instrument cluster, the system may have been deactivated due to signal interference. Start the vehicle again and check if Parking Assist PARKTRONIC is working at a different location.

If the  symbol appears in the instrument cluster and a warning tone sounds, it may be due to one of the following causes:

- **The sensors are dirty:** clean the sensors and observe the notes on care of vehicle parts (→ page 277).
- **Parking Assist PARKTRONIC has been deactivated due to a malfunction:** restart the vehicle. If the problem persists, consult a qualified specialist workshop.

### Function of the passive side impact protection

Passive side impact protection is an additional Parking Assist PARKTRONIC function which warns the driver about obstacles at the side of the vehicle. A warning is issued when obstacles are detected between the front and rear detection range. In order for an object on the side to be detected, the sensors in the front and rear bumper must first detect the object while you are driving past it.

During the parking procedure or when maneuvering, objects are detected as the vehicle drives past. If you steer in the direction of a detected obstacle and there is a risk of a lateral collision, a

warning is issued and the segments light up in color in the display.

The segment color changes depending on the distance to the detected obstacle:

- **Yellow:** approximately 1.0 - 2.0 ft (30 - 60 cm)
- **Red:** less than approximately 1.0 ft (30 cm)

In order for lateral front or rear segments to be displayed, the vehicle must first travel a distance of at least half of the vehicle length. Once the vehicle has traveled the length of the vehicle, all of the lateral front and rear segments can be displayed.

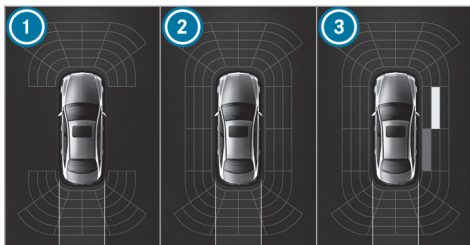

Parking Assist PARKTRONIC display: vehicles without a surround view camera

- ① Operational front and rear
- ② Operational front, rear and sides
- ③ Obstacle detected at the front right (yellow) and rear (red)

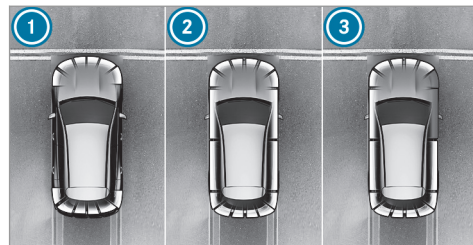

Parking Assist PARKTRONIC display: vehicles with a surround view camera

- ① Operational front and rear
- ② Operational front, rear and sides
- ③ Obstacles detected at the front right (red)

Saved obstacles on the sides are deleted in the following situations, for example:

- You park the vehicle and switch off the ignition.
- You open the doors.

After the engine is restarted, obstacles on the sides must be detected again before a new warning can be issued.

**System limits**

The system limits for Parking Assist PARKTRONIC apply to passive side impact protection.

The following objects are not detected, for example:

- Pedestrians who approach the vehicle from the side
- Objects placed next to the vehicle

**Activating/deactivating Parking Assist PARKTRONIC**



**!** **NOTE** Risk of an accident from objects at close range

Parking Assist PARKTRONIC may not detect certain objects at close range.

- ▶ When parking or maneuvering the vehicle, pay particular attention to any objects which are above or below the sensors, e.g. flower pots or drawbars. The vehicle or other objects could otherwise be damaged.

▶ **Vehicles without AIR BODY CONTROL:** press the  button in the center console.

**i** **Vehicles with AIR BODY CONTROL:** you can activate or deactivate Parking Assist PARKTRONIC in the multimedia system (→ page 209).

If the indicator lamp in the  button is not lit, Parking Assist PARKTRONIC is active. If the indicator lamp is lit or the  symbol appears in the Instrument Display, Parking Assist PARKTRONIC is not active.

**i** Parking Assist PARKTRONIC is automatically activated when the vehicle is started.

**Activating/deactivating Parking Assist PARKTRONIC using the multimedia system**

**!** **NOTE** Risk of an accident from objects at close range

Parking Assist PARKTRONIC may not detect certain objects at close range.

- ▶ When parking or maneuvering the vehicle, pay particular attention to any objects which are above or below the

sensors, e.g. flower pots or drawbars. The vehicle or other objects could otherwise be damaged.

**Requirements:**

- The camera menu is open.
- Or: Active Parking Assist is active.
- Or: the PARKTRONIC pop-up window appears.

▶ Tap  on the media display.

If the indicator lamp is lit, Parking Assist PARKTRONIC is active. If the indicator lamp is not lit or the  symbol appears in the instrument cluster, Parking Assist PARKTRONIC is not active.

**i** Parking Assist PARKTRONIC is automatically activated when the vehicle is started.

Alternatively, Parking Assist PARKTRONIC can be activated or deactivated in the quick access menu.

### Setting the warning tones of Parking Assist PARKTRONIC

Multimedia system:

- ▶ ▶  ▶▶ Settings ▶▶ Assistance
- ▶▶ Camera & Parking

#### Adjusting the volume of the warning tones

- ▶ Select **Warning Tone Volume**.
- ▶ Set a value.

#### Adjusting the pitch of the warning tones

- ▶ Select **Warning Tone Pitch**.
- ▶ Set a value.

#### Specifying the starting point for the warning tones

You can specify whether the Parking Assist PARKTRONIC warning tones should commence when the vehicle is further away from an obstacle.

- ▶ Select **Warn Early All Around**.
- ▶ Switch the function on or off.

#### Activating/deactivating audio fadeout

You can specify whether the volume of a media source in the multimedia system is to be reduced

when Parking Assist PARKTRONIC sounds a warning tone.

- ▶ Select **Audio Fadeout During Warning Tones**.
- ▶ Switch the function on or off.

### Active Parking Assist

#### Function of Active Parking Assist

Active Parking Assist is an electronic parking assistance system, which uses ultrasound with the assistance of the rear view camera and surround view camera. When you are driving forwards up to approximately 22 mph (35 km/h), the system automatically measures parking spaces on both sides of the vehicle.

Vehicles with rear view camera

- Parking in parking spaces parallel to the road

Vehicles with surround view camera

- Parking in parking spaces parallel to the road
- Parking in parking spaces perpendicular to the road (optionally either forwards or reverse)

- Parking in parking spaces that can only be detected as such due to markings (for example at the roadside)
- Exiting parking spaces if you have parked using Active Parking Assist

As soon as all requirements are met for searching for parking spaces, the  display appears in the Instrument Display.

When Active Parking Assist has detected parking spaces, the  display appears in the Instrument Display. The arrows show on which side of the road detected parking spaces are located. They are then shown on the media display.

**Vehicles with rear view camera:** the parking space can be selected as desired. The vehicle is parked in reverse.

**Vehicles with surround view camera:** the parking space can be selected as desired. Depending on the location of the parking space, the parking direction (rearwards or forwards) can also be selected as desired.

When Active Parking Assist is activated, the turn signal indicators are activated based on the calculated path of your vehicle.

The parking procedure is assisted by accelerating, braking, steering and gear changes.

Active Parking Assist is only an aid. It is not a substitute for your attention to the surroundings. The responsibility for safe maneuvering and parking remains with you. Make sure that no persons, animals or objects etc. are in the maneuvering range.

Active Parking Assist will be canceled in the following situations:

- Parking Assist PARKTRONIC is deactivated.
- You begin steering.
- You engage transmission position **P**.
- ESP® intervenes.
- You open the driver's door.
- After activating Active Parking Assist, you press the  button again (→ page 212).

### System limits

If the exterior lighting is malfunctioning, Active Parking Assist is not available.

Objects located above or below the detection range of the sensors, e.g. overhanging loads, overhangs or loading ramps of trucks, or the borders of parking spaces, are not detected during measurement of the parking space. These are also then not taken into account when calculating the parking procedure. In some circumstances, Active Parking Assist may therefore guide you into the parking space incorrectly.

**⚠ WARNING** Risk of accident due to objects located above or below the detection range of Active Parking Assist

If there are objects above or below the detection range, the following situations may arise:

- Active Parking Assist may steer too early.
- The vehicle may not stop in front of these objects.

There is a danger of collision!

▶ In these situations, do not use Active Parking Assist.

Extreme weather conditions, such as snow or heavy rain, may lead to a parking space being measured inaccurately. Parking spaces that are partially occupied by trailer drawbars might not be identified as such or be measured incorrectly. Only use Active Parking Assist on level, high-grip ground.

Do not use Active Parking Assist in the following situations:

- In extreme weather conditions such as ice, packed snow or in heavy rain.
- When transporting a load that protrudes beyond the vehicle.
- On steep uphill or downhill gradients of more than approximately 15%.
- When snow chains are installed.
- Directly after a tire change or when spare tires are installed.
- If the tire pressure is too low or too high.

## 212 Driving and parking

- If the suspension is out of alignment, e.g. after bottoming out on a curb.

Active Parking Assist may also display parking spaces that are not suitable for parking, such as:

- Parking spaces where parking is prohibited.
- Parking spaces on unsuitable surfaces.

### Parking with Active Parking Assist

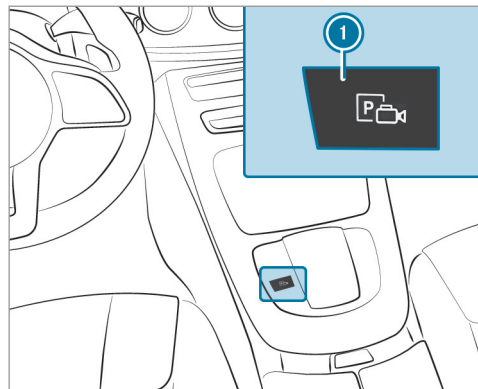

- ▶ Press button ①.



Parking spaces detected by the system are shown in the media display. When the vehicle is stationary, indicated vehicle path ② into currently selected parking space ③ also appears.

- ▶ If a parking space is displayed: stop the vehicle.
- ▶ If necessary, select another parking space.
- ▶ **Vehicles with surround view camera:** if necessary, change the parking direction.
- ▶ **To start the parking procedure:** confirm selected parking space ③.

The turn signal indicator is switched on automatically when the parking procedure begins. You are responsible for selecting the turn signal indicator in accordance with the traffic conditions. If necessary, select the turn signal indicator accordingly.

**⚠ WARNING** Risk of accident due to vehicle swinging out while parking or pulling out of a parking space

While parking or exiting a parking space, the vehicle swings out and can drive onto areas of the oncoming lane.

This could cause you to collide with objects or other road users.

- ▶ Pay attention to objects and other road users.
- ▶ Where necessary, stop the vehicle or cancel the parking procedure with Active Parking Assist.

- ▶ If, for example, the [Please Engage Reverse Gear](#) message appears in the media display:



select the corresponding transmission position.

The vehicle drives into the selected parking space.

- During the parking procedure with Active Parking Assist, the lane markings are displayed in green in the camera image.

On completion of the parking procedure, the **Parking Assist Finished, Take Control of Vehicle** message appears. Further maneuvering may still be necessary.

- Secure the vehicle against rolling away. When required by legal requirements or local conditions: turn the wheels towards the curb.

- You can stop the vehicle and change the transmission position during the parking procedure. The system then calculates a new vehicle path. If no new vehicle path is available, the transmission position can be changed again, or the process can be canceled.

### Exiting a parking space with Active Parking Assist

#### Requirements:

- The vehicle is equipped with a surround view camera.
- The vehicle has been parked with Active Parking Assist.

Please note that you are responsible for the vehicle and surroundings during the entire parking procedure.

- Start the vehicle.
- Press button ①. The media display shows the view of Active Parking Assist.

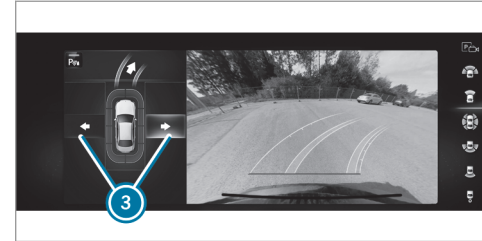
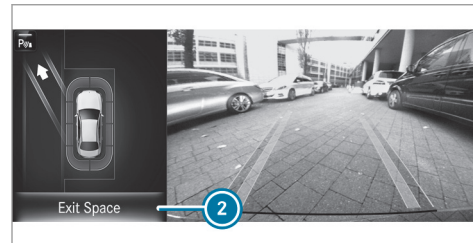

- Select **Exit Space** ②.

or

- If the vehicle has been parked perpendicular to the direction of travel: select direction of travel ③.
- If, for example, the **Please Engage Forward Gear** message appears on the media display: select the corresponding transmission position.

The vehicle moves out of the parking space and is brought to a standstill by Active Parking Assist (at an angle to the direction of travel).

The  **Parking Assist Finished, Take Control of Vehicle** message appears.

▶ Take control of the vehicle and complete the parking process.

ⓘ The vehicle path shown on the media display may differ from the actual vehicle path. The turn signal indicator is switched on automatically when the exiting procedure begins.

You are responsible for selecting the turn signal indicator in accordance with the traffic conditions. If necessary, select the turn signal indicator accordingly.

#### Pausing Active Parking Assist

You can interrupt the parking or exiting procedure of Active Parking Assist by performing one of the following actions, for example:

- ▶ Depressing the brake pedal
- ▶ Applying the electric parking brake or activating the HOLD function

▶ **To resume the parking or exiting procedure:** gently depress the accelerator pedal.

ⓘ If the electric parking brake was applied before Active Parking Assist was activated, depress the accelerator pedal lightly to start the parking or exiting procedure.

Check the area around your vehicle again before resuming a paused parking procedure. Make sure that persons, animals or objects are no longer in the maneuvering range. Also observe the system limitations of Active Parking Assist.

#### Automatic braking function of Active Parking Assist

Persons or objects detected in the maneuvering range could cause the vehicle to brake sharply and interrupt the parking or exiting procedure. The vehicle will then be held at a standstill. If you depress the accelerator pedal, the parking or exiting procedure is resumed.

Check the area around your vehicle again before resuming the parking or exiting procedure. Make sure that persons, animals or objects are no longer in the maneuvering range. Also observe the system limitations of Active Parking Assist.

#### Maneuvering assistance

##### Function of Drive Away Assist

Drive Away Assist can reduce the severity of an impact when pulling away. If an obstacle is detected in the direction of travel, the vehicle's speed

is briefly reduced to approx. 1 mph (2 km/h). If a critical situation is detected, the  symbol appears in the media display.

Drive Away Assist can be deactivated or activated in the **Maneuvering Assistance** menu (→ page 215).

ⓘ You can cancel an intervention by Drive Away Assist at any time by deactivating Parking Assist PARKTRONIC (→ page 209).

**⚠ WARNING** Risk of accident caused by limited detection performance of Drive Away Assist

Drive Away Assist cannot always clearly identify objects and traffic situations.

- ▶ Always pay careful attention to the traffic situation; do not rely on Drive Away Assist alone.
- ▶ Be prepared to brake or swerve as necessary, provided the traffic situation permits and that it is safe to take evasive action.

Drive Away Assist is only an aid. It is not a substitute for your attention to the surroundings. The responsibility for safe maneuvering and parking remains with you. Make sure that no persons, animals or objects etc. are in the maneuvering range.

A risk of collision may occur in the following situations, for example:

- If the accelerator and brake pedals are interchanged.
- If an incorrect transmission position is engaged.

Drive Away Assist is active under the following conditions:

- If Parking Assist PARKTRONIC is activated.
- If you shift the transmission position to **R** or **D** when the vehicle is stationary.
- If the detected obstacle is less than approx. 3.3 ft (1.0 m) away.
- If the maneuvering assistance function is activated in the multimedia system.

### System limits

The performance of Drive Away Assist is limited on inclines.

- ① Also observe the system limits of Parking Assist PARKTRONIC (→ page 204).

### Function of Cross Traffic Alert

- ① Cross Traffic Alert is only available for vehicles with Blind Spot Assist or Active Blind Spot Assist.

Cross Traffic Alert can warn drivers of any crossing traffic when backing up and maneuvering out of a parking space. The radar sensors in the bumper also monitor the area adjacent to the vehicle. If a critical situation is detected, the  symbol appears in the media display and the vehicle can be braked automatically.

If the radar sensors are obstructed by vehicles or other objects, detection is not possible.

- ① Also observe the instructions on Blind Spot Assist and Active Blind Spot Assist (→ page 192).

### System limits

Cross Traffic Alert is not available on inclines.

### Activating/deactivating maneuvering assistance

Multimedia system:

 [Settings](#) [Assistance](#)

[Camera & Parking](#)

 Switch [Maneuvering Assistance](#) on or off.

### Vehicle towing instructions

The vehicle is not suitable for the use of tow bar systems that are used for flat towing or dinghy towing, for example. Attaching and using tow bar systems can result in damage to the vehicle. When you are towing a vehicle with tow bar systems, safe driving characteristics cannot be guaranteed for the towing vehicle or the towed vehicle. The vehicle-trailer combination may swerve from side to side.

Observe the following information:

- Permitted towing methods (→ page 293)
- The notes on towing the vehicle with both axles on the ground (→ page 294)

### Notes on the instrument display and on-board computer

**⚠ WARNING** Risk of accident if the instrument display fails

If the instrument display has failed or is malfunctioning, function restrictions in systems relevant to safety cannot be detected.

The operating safety of your vehicle may be impaired.

- ▶ Drive on carefully.
- ▶ Have the vehicle checked immediately at a qualified specialist workshop.

**⚠ WARNING** Risk of distraction due to information systems and communications equipment

If you operate information systems and communications equipment integrated in the vehicle when driving, you could be distracted from the traffic situation. This could also cause you to lose control of the vehicle.

- ▶ Only operate this equipment when the traffic situation permits.
- ▶ If you cannot be sure of this, stop the vehicle in accordance with the traffic conditions and operate the equipment with the vehicle stationary.

**! NOTE** Mercedes-AMG vehicles

- ▶ Observe the notes in the Supplement. You could otherwise fail to recognize dangers.

You must observe the legal requirements for the country in which you are currently driving when operating the on-board computer.

The on-board computer shows only display messages and warnings from specific systems on the instrument display. You must therefore ensure that your vehicle is always reliable.

If the operating safety of your vehicle is impaired, park the vehicle immediately and in accordance with the traffic conditions. Contact a qualified specialist workshop.

## Overview of instrument display

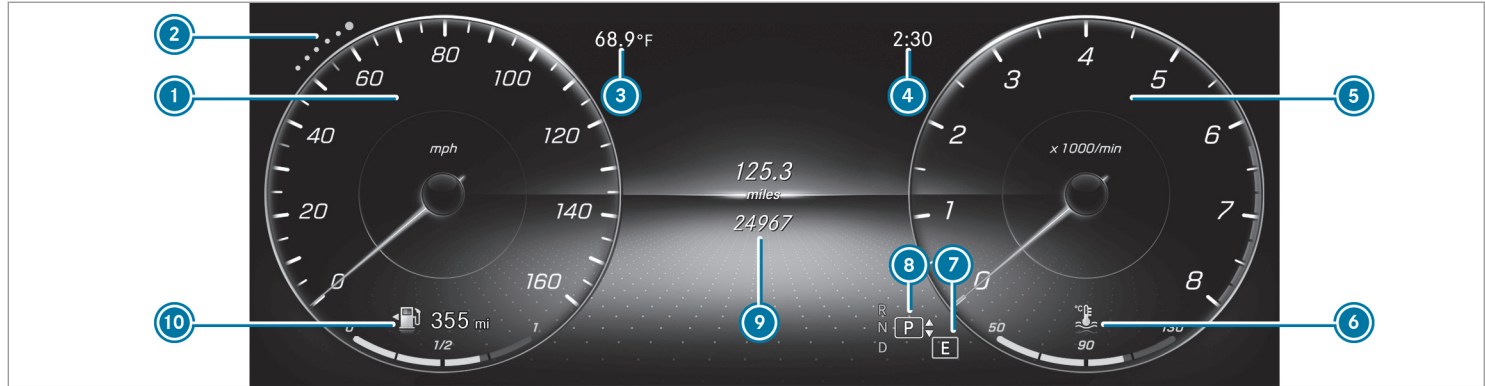

- ① Speedometer  
The segments on the speedometer indicate the statuses of the following systems: cruise control/limiter/Active Distance Assist DISTRONIC
- ② Index points
- ③ Outside temperature

- ④ Time
- ⑤ Area for additional values (example: tachometer): tachometer/navigation/ECO display/consumption/G-meter/date  
The fuel supply will be interrupted to protect the engine when the red mark on the tachometer (overrevving range) is reached.
- ⑥ Coolant temperature display



- During normal operation, coolant temperature display ⑥ is permitted to rise to the red mark.
- Vehicles with 48 V on-board electrical system: POWER and CHARGE displays (electrical drive support and recuperation power of the electric motor)
- ⑦ Selected drive program

- ⑧ Selected transmission position
- ⑨ Center display area of the instrument display (example: standard display for a trip): assistance/telephone/navigation/trip/media/radio/styles and displays/service/possible settings for Head-up Display
- ⑩ Fuel level and fuel filler flap location indicator

### Overview of buttons on the steering wheel

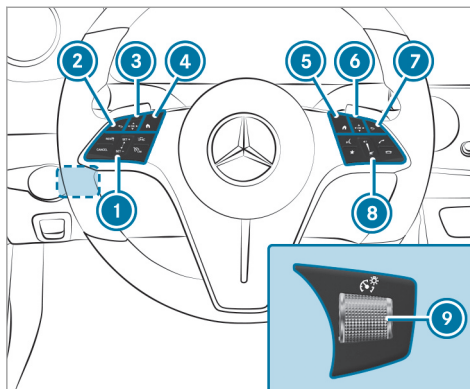
Depending on the equipment, the layout and the design of the control elements on the steering wheel may differ.



- ① Control panel for cruise control or Active Distance Assist DISTRONIC (→ page 171)
- ②  Back button, on-board computer
- ③ Touch Control, on-board computer  
To navigate: swipe  
To confirm: press
- ④  Main menu, on-board computer
- ⑤  Main menu, MBUX multimedia system

- ⑥ Touch Control, MBUX multimedia system  
To navigate: swipe  
To confirm: press
- ⑦  Back button, MBUX multimedia system
- ⑧ Control panel for the MBUX multimedia system
- ⑨ Adjusts the brightness of the instrument lighting

### Operating the on-board computer

Observe the legal requirements for the country in which you are currently driving when operating the on-board computer.



The on-board computer is operated using the left-hand Touch Control and the left-hand back/home button.

- ❶ To operate the Touch Control in the most effective way, use the tip of your thumb if possible.

The following menus are available:

- Assistance
- Phone
- Navigation
- Trip
- Radio
- Media

- Service
- Vehicles with an instrument display in the widescreen cockpit: [Designs](#)

- ❶ You can find information about the possible settings and selections on the menus in the Digital Operator's Manual.

The menu can be called up from the menu bar on the instrument display.

- ▶ **To call up the menu bar:** press the left-hand back button until the menu bar is displayed.

- ❶ **Vehicles without Active Distance Assist DISTRONIC:** press the  button to call up the menu bar of the on-board computer.

- ▶ **To scroll on the menu bar:** swipe left or right on the left-hand Touch Control.

- ▶ **To call up a menu, submenu or possible settings on the menu, or confirm a selection or setting:** press the left-hand Touch Control.

- ▶ **To scroll through displays or lists on the menu, or select display content, a function, an entry or a display:** swipe upwards or downwards on the left-hand Touch Control.

- ▶ **To exit a submenu:** press the left-hand back button.

### Selecting the Head-up Display

- ▶ **To switch on the Head-up Display:** switch on the Head-up Display via the multimedia system or activate it on the menu bar by swiping upwards on the left-hand Touch Control. The Head-up Display menu will be selected on the Head-up Display.

- ▶ **To switch to the Head-up Display:** press the left-hand Touch Control or swipe upwards on the left-hand Touch Control.

- ▶ **To set the three display ranges of the Head-up Display:** swipe upwards or downwards on the left-hand Touch Control.

### Full-screen menus











You can display the following menus full-screen on the instrument display:



- Assistance
- Trip
- Navigation

- ▶ On the corresponding menu, use the left-hand Touch Control to scroll to the end of the list.
- ▶ Press the left-hand Touch Control. The selected menu will be displayed full-screen.

### Overview of displays on the instrument display

Displays on the instrument display:

-  Active Parking Assist activated (→ page 212)
-  Parking Assist PARKTRONIC deactivated (→ page 209)
-  Cruise control (→ page 170)
-  Active Distance Assist DISTRONIC (→ page 172)
-  Active Brake Assist (→ page 187)
-  Active Steering Assist (→ page 179)
-  Active Stop-and-Go Assist (→ page 178)
-  Active Lane Keeping Assist (→ page 194)
-  Active Lane Change Assist (→ page 182)
-  ECO start/stop function (→ page 142)

-  HOLD function (→ page 167)
-  Adaptive Highbeam Assist (→ page 116)
- Adaptive Highbeam Assist Plus (→ page 117)

**Vehicles with Traffic Sign Assist:** Detected instructions and traffic signs (→ page 188).

For an overview of the indicator and warning lamps, see (→ page 397).

### Head-up Display

#### Function of the Head-up Display

#### ! NOTE Mercedes-AMG vehicles

- ▶ Observe the notes in the Supplement. You could otherwise fail to recognize dangers.

The Head-up Display projects the following information into the driver's field of vision above the cockpit, for example:

- The vehicle speed
- Information from the navigation system

- Information from the driving systems and driving safety systems
- Some warning messages

Depending on the vehicle's equipment, different content can be shown in the three areas of the Head-up Display (→ page 221).

#### Display content

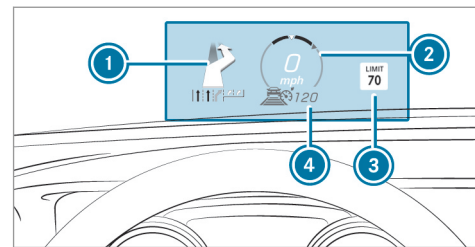

- ① Navigation instructions
- ② Current speed
- ③ Detected instructions and traffic signs
- ④ Set speed in the driving system (e.g. cruise control)



### System limits

The visibility of the displays will be affected by the following conditions:

- Seat position
- Image position setting
- Ambient light
- Wet road surface
- Objects on the display cover
- Polarization in sunglasses

**i** In extreme sunlight, sections of the display may appear washed out. You can correct this by switching the Head-up Display off and on again.

### Setting the Head-up Display using the on-board computer

On-board computer:

#### ➔ HEAD-UP DISPLAY

The following Head-up Display settings or displays can be selected or shown:

- Position

- Brightness
- Messages
- Assistance status
- Telephone
- Audio
- Voice Control System

▶ **To select the Settings menu:** swipe to the right on the left-hand Touch Control. The Settings menu **5** will be selected.

▶ **To call up the Settings menu:** press the left-hand Touch Control.

▶ **To adjust the position:** swipe upwards or downwards on the left-hand Touch Control.

▶ **To adjust the brightness:** swipe to the left or right on the left-hand Touch Control.

### Setting messages, assistance status, telephone, audio and the Voice Control System

▶ Press the left-hand Touch Control. The list of setting options will be displayed.

▶ Swipe upwards or downwards on the left-hand Touch Control and select a setting by pressing the left-hand Touch Control.

### Selecting what the Head-up Display shows

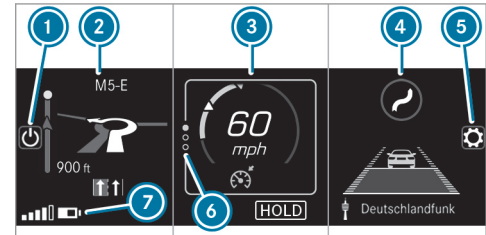

(Example)

- 1 Switches the Head-up Display on/off
- 2 Left display area  
Navigation system  
Average consumption  
G-meter
- 3 Central display area  
Speedometer

Set speed in the driver assistance system, e.g. cruise control

Warnings from driver assistance systems, e.g. distance warning

- ④ Right display area  
Traffic Sign Assist  
Assistant display
- ⑤ To adjust the position, brightness and lower display area
- ⑥ Index points
- ⑦ Lower display area (example: left display area)

Display areas ② to ④ that are not required can be hidden.

- ① In audio mode, the station name or track will be shown temporarily when the audio source is being actively operated. In addition, the latest calls will be displayed when the telephone list on the instrument display is actively operated.

- ▶ Swipe upwards on the left-hand Touch Control.
- ▶ Press the left-hand Touch Control.

### Switching the Head-up Display on/off via the multimedia system

---

Multimedia system:

▶  ▶ Settings ▶ Quick Access

- ▶ Select HUD.  
The Head-up Display is activated.

## Overview and operation

### Notes on the MBUX multimedia system

**⚠ WARNING** Risk of distraction due to information systems and communications equipment

If you operate information systems and communications equipment integrated in the vehicle when driving, you could be distracted from the traffic situation. This could also cause you to lose control of the vehicle.

- ▶ Only operate this equipment when the traffic situation permits.
- ▶ If you cannot be sure of this, stop the vehicle in accordance with the traffic conditions and operate the equipment with the vehicle stationary.



You must observe the legal requirements for the country in which you are currently driving when operating the multimedia system. Depending on the equipment, the scope of function and product designation of your MBUX multimedia system may differ from the description and

images in this Operator's Manual. For example, route guidance with augmented reality is not available in all equipment variants.

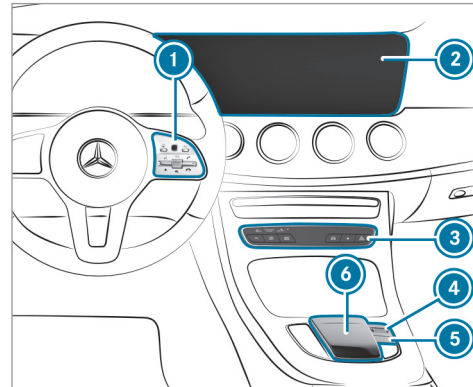
### Overview of the MBUX multimedia system



- ① Touch Control and control panel for the MBUX multimedia system
- ② Media display with touch functionality

- ③ Control panel for telephone, navigation, radio/media, vehicle functions/system settings and favorites/themes
- ④ Controller
  - Turn: adjusts the volume
  - Press: switches sound on or off
  - For Mercedes-AMG vehicles with AMG Performance exhaust system:
    - Turn: adjusts the volume
    - Press briefly: switches the mute function on/off
    - Press and hold: switches the multimedia system on/off
- ⑤  Switches the MBUX multimedia system or media display on or off
  - For Mercedes-AMG vehicles with AMG Performance exhaust system:
    -  button
      - Sets the sound characteristic of the AMG Performance exhaust system
- ⑥ Touchpad

Further operating options:

- Conducting a voice dialog with the Voice Control System.
  - Operating functions contact-free with the MBUX Interior Assistant.
-  You can find further information about operation as well as about applications and services in the Digital Operator's Manual.

### **Anti-theft protection**

This device is equipped with technical provisions to protect it against theft. Further information on protection against theft can be obtained from an authorized Mercedes-Benz Center.

## Home screen overview

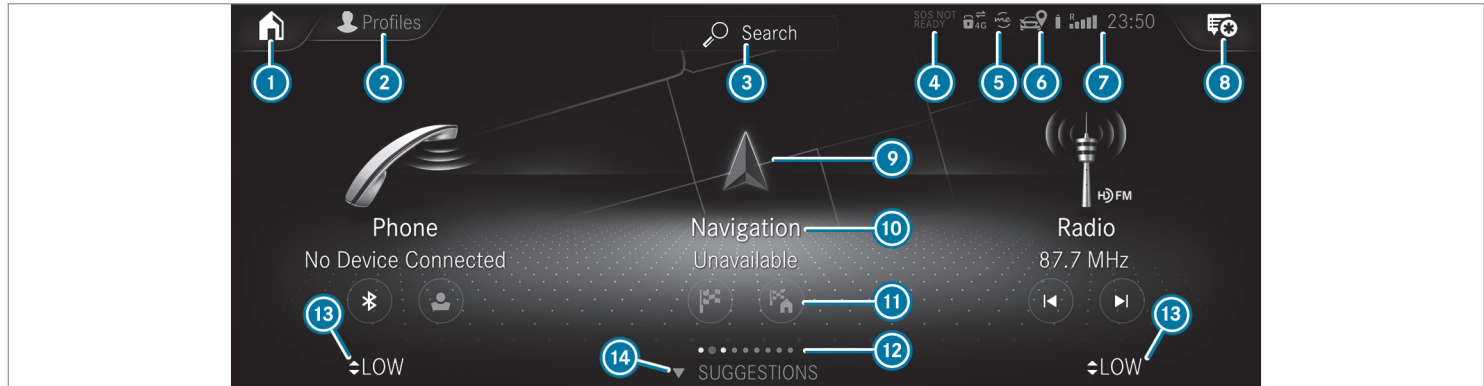

- ① Depending on the display, calls up the first three applications or the home screen
- ② Calls up the profile
- ③ Calls up the global search
- ④ SOS NOT READY (only when the Mercedes-Benz emergency call system is not available)
- ⑤ Mercedes me connect active
- ⑥ Transmission of vehicle position active

- ⑦ Signal strength of the mobile phone network, network display, battery status of the mobile phone connected, time
- ⑧ Calls up the Notifications Center
- ⑨ Calls up an application using the symbol
- ⑩ Application and current information
- ⑪ Quick-access, e.g. enter home address
- ⑫ Index points and selected display area

- ⑬ Calls up the air conditioning menu
- ⑭ Calls up **SUGGESTIONS, THEMES** and **FAVORITES**

- i** If Mercedes me connect **5** is active, the vehicle is linked with Mercedes me connect. Vehicle data is then transmitted to the back-end system. What data is transmitted depends on which services are activated. Further details can be found in the Mercedes me connect terms and conditions and data protection information. The function is country-dependent.
- If transmission of vehicle position **6** is active, Mercedes me connect services have been activated for this vehicle which access the vehicle's geolocation. In which instances the geolocation is transmitted depends on the particular services. Further details can be found in the Mercedes me connect terms and conditions and data protection information. The function is country-dependent.

## Operating the MBUX multimedia system

### Using Touch Control

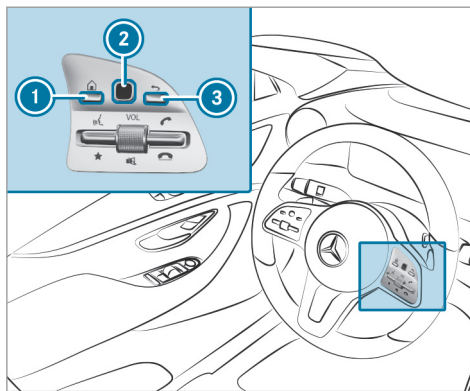

- 1** Shows the home screen
- 2** Touch Control  
Swipe up, down, to the left and right (to navigate) and press (to confirm)
- 3** Returns to the previous display

Navigation through the menus is carried out with Touch Control **2** with single-finger swipes.

- ▶ **To select a menu option:** swipe and press.
- ▶ **To move the digital map:** swipe in any direction.



### Using the touchscreen

- ▶ Select menu options, symbols or characters by pressing briefly.
- ▶ **To navigate in menus:** swipe up, down, left or right.
- ▶ **To use handwriting to enter characters:** write the character with one finger on the touchscreen.
- ▶ **To zoom in and out of the map:** move two fingers together or apart.
- ▶ **To call up the global menu:** press and hold on the touchscreen until the **OPTIONS** menu appears.

- i** For more information on operation, please refer to the Digital Operator's Manual.

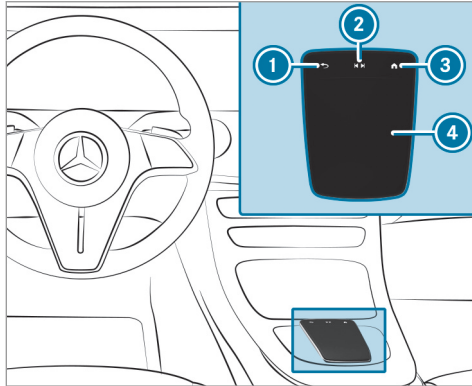
## Using the touchpad







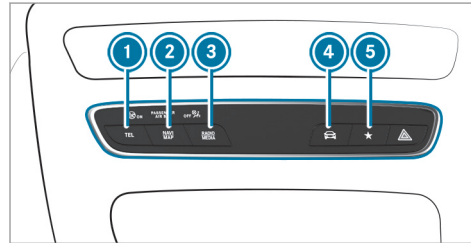

- ①  Returns to the previous display
- ②  Calls up the audio control menu
- ③  Calls up the home screen
- ④ Touchpad

▶ **To select a menu option:** swipe and press.

- ▶ **To use handwriting recognition:** write a character on the touchpad.
- ▶ **To open or close the Notifications Center:** swipe down or up with two fingers.
- ▶ **To zoom in and out of the map:** move two fingers together or apart.

## Calling up applications using buttons



- ①  button calls up the telephone
- ②  button calls up navigation
- ③  button calls up radio or media
- ④  button calls up vehicle functions
- ⑤  button

Press briefly: calls up favorites  
 Press and hold: adds a favorite or creates a new theme

- ▶ Alternatively, tap  on the touchscreen.
- ▶ Call up the application (→ page 225).

## Functions of the Voice Control System

**⚠ WARNING** Risk of distraction due to information systems and communications equipment

If you operate information systems and communications equipment integrated in the vehicle when driving, you could be distracted from the traffic situation. This could also cause you to lose control of the vehicle.

- ▶ Only operate this equipment when the traffic situation permits.
- ▶ If you cannot be sure of this, stop the vehicle in accordance with the traffic conditions and operate the equipment with the vehicle stationary.

For your own safety, always observe the following points when operating mobile communications equipment and especially your voice control system:

- Observe the legal requirements for the country in which you are driving.
- If you use the voice control system in an emergency your voice can change and your telephone call, e.g. an emergency call, can thereby be unnecessarily delayed.
- Familiarize yourself with the voice control system functions before starting the journey.

With the Voice Control System, various applications in the MBUX multimedia system are operable using voice input. The Voice Control System is operational approximately thirty seconds after the ignition is switched on and is available for the driver's seat and front passenger seat.

The following multimedia system applications can be operated:

- Telephone
- Text message and e-mail
- Navigation

- Address book
- Radio
- Media
- Vehicle functions

### Starting the Voice Control System

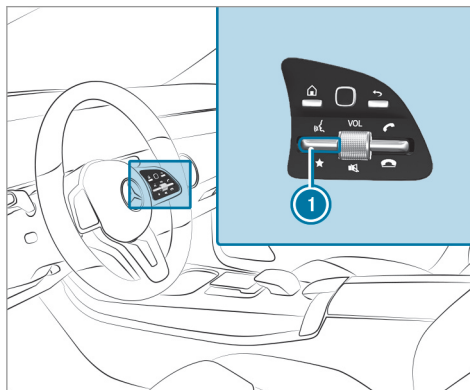

▶ Press rocker switch ① up.

or

▶ Say "Hello Mercedes".

### Overview of the MBUX Interior Assistant

**⚠ WARNING** Risk of injury from the camera's laser radiation

This product uses a classification 1 laser system. If the housing is opened or damaged, laser radiation may damage your retina.

- ▶ Do not open the housing.
- ▶ Always have maintenance work and repairs carried out by a qualified specialist workshop.

This product complies with the requirements of the FDA 21 CFR 1040.10 and 1040.11 with exception of the variations according to the FDA Laser Notice No. 50 from 24. June 2007.

The camera is located in the overhead control panel.

If the vehicle is equipped with the MBUX Interior Assistant, selected functions of the multimedia



system can be operated contact-free. The MBUX Interior Assistant can differentiate between driver and front passenger interactions and detects specific hand positions (poses).

### System limits, display messages and notes for rectification

The system may be impaired or may not function in the following situations:

- The camera in the overhead control panel may heat up due to operating conditions. As a result the camera may switch off temporarily,

particularly during longer periods of operation and at high outside temperatures.

Do not touch or cover the camera and wait until the camera has cooled down and is available again.

- The camera is covered, dirty, fogged up or scratched.

Wait until the camera has cooled down before cleaning the camera lens.

Clean the outside of the camera lens with a dry or damp cotton cloth. Do not use micro-

fiber cloths. Do **not** remove the cover when cleaning.

- Recognition can be impaired by reflective clothing, an adverse color of clothing or by accessories, for example.
- Clothing being worn (hat, shawl, scarf) may be limiting the detection area of the camera. Keep the camera's field of vision clear.
- The camera is not operational. Consult an authorized Mercedes-Benz Center.

### The MBUX Interior Assistant supports the following interactions:

Interaction area	Interaction	Description
In front of the media display or above the touchpad	Proximity to the control element	The Interior Assistant recognizes the approach of the hand towards a control element. Depending on the active application, the display will be adjusted in the media display. Some functions differentiate between driver and front passenger. No specific hand position is required.
Above the center console	Defined pose	A favorite is called up with a defined pose.

Interaction area	Interaction	Description
Below the inside rearview mirror	Brief up and down movements	With brief vertical up and down movements below the inside rearview mirror the reading light for the driver or the front passenger is switched on and off.
Above the front passenger seat	Stretching out a hand above the front passenger seat	By stretching out a hand above the front passenger seat the search light is switched on. If you withdraw a hand from this area, the search light is switched off again.

### Switching the reading light and search light and on or off

#### Requirements:

- **For the reading light:** the function is available when it is dark.
- The hand movement takes place in the interaction area below the inside rearview mirror.
- **For the search light:** the function is available when it is dark.
- The hand movement takes place in the interaction area above the front passenger seat.
- The seat belt on the front passenger seat must **not** be inserted in the seat belt buckle.

#### Switching the reading light on and off



- ▶ Briefly move a hand up or down beneath the inside rearview mirror. The reading light is switched on or off for the driver or the front passenger.

#### Switching the search light on and off

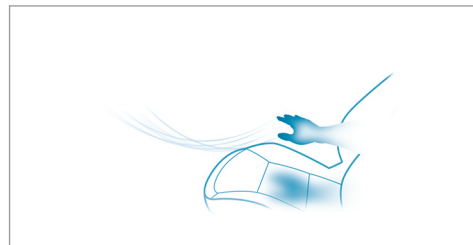

- ▶ **To switch on:** reach across the front passenger seat with a hand. The search light is switched on for the driver.

- ▶ **To switch off:** take a hand back away from the front passenger seat.  
The search light is switched off again.

### Information on profiles, themes, suggestions and favorites

For electrically adjustable seats observe the following notes.

**⚠ WARNING** Risk of becoming trapped during adjustment of the driver's seat after calling up a driver profile

Selecting a user profile may trigger an adjustment of the driver's seat to the position saved under the user profile. You or other vehicle occupants could be injured in the process.

- ▶ Make sure that when the position of driver's seat is being adjusted using the multimedia system, no people or body parts are in the seat's range of movement.

If there is a risk of someone becoming trapped, stop the adjustment process immediately:

- ▶ a) Tap the warning message on the media display.
- or
- ▶ b) Press a memory position button or a seat adjustment switch on the driver's door.  
The adjustment process will be stopped.

The driver's seat is equipped with an access preventer.

If the driver's door is open, the driver's seat will **not** be set after calling up the driver's profile.

Profiles store your vehicle settings and settings for the multimedia system. If the vehicle is used by several drivers, the driver can select their own profile without changing the stored profile settings of other drivers.

- ⓘ Information on profiles from Mercedes me connect can be found in the Digital Operator's Manual.

Vehicle settings are, for example, driver's seat, steering wheel and mirror settings, climate control and ambient lighting. For the settings of the multimedia system, you can select, for example, radio

stations, previous destinations as well as themes, suggestions and favorites.

For recurring driving situations, such as long drives on the highway, you can save your preferred settings in a theme in the vehicle. In a theme you can save the display of the digital map, your preferred radio station and preferred drive program, for example.

The vehicle can learn the habits of the driver. It then offers suggestions for the most probable navigation destinations, media sources, radio stations or contacts. The requirements for that are the selection of a profile, your consent to the recording of data and sufficient collected data.

Favorites provide quick access to applications that are used often. You can select favorites from categories or add them directly to an application.

## Configuring profiles, themes and suggestions

Multimedia system:



### Creating a new profile

- ▶ Select **Create Profile** .
- ▶ Select an avatar.
- ▶ Enter the name and confirm with .
- ▶ Select **Continue** .
- ▶ Select **Current Settings**.
- ▶ Select **Save**.
- ▶ Activate Bluetooth® and select **Connect Phone**, to connect a mobile phone with the user profile .
- ▶ Select **Finish**.

### Selecting profile options

- ▶ Select for a profile.
- The following functions are available:
- Editing, resetting or deleting a profile
  - Resetting themes or favorites

- Configuring suggestions

### Configuring suggestions

- ▶ Select for a profile.
- ▶ Select **Suggestion Settings**.
- ▶ Switch **Allow Destination Suggestions**, **Allow Music Suggestions** and **Allow Contact Suggestions** on or off.
- ▶ **To deactivate the learning function for one day:** activate **Deact. Learning for 24 h**.  
For 24 hours no new actions will be trained and no data recorded for the active profile. Suggestions will continue to be shown.  
Example: if the option is switched on and a route to a new destination has been calculated, this destination would not be taken into account for the learning function.

### Creating new themes

- ▶ Select .
- ▶ Select **THEMES**.

- ▶ Select **Create Theme**.  
The settings which are saved in the theme are shown.
- ▶ Select **Continue** .
- ▶ Select **Audio** and **Navigation** (Navigation) and store the active settings in the theme.
- ▶ Select **Continue** .
- ▶ Select an entry screen.
- ▶ Select **Continue** .
- ▶ Select an image.
- ▶ Enter the names into the entry field and confirm with .
- ▶ Select **Save**.

## System settings

### Overview of the system settings menu

In the system settings menu, you can make settings in the following menus and control elements:

- Display
  - Styles

- Instrument lighting
- Display brightness
- Edge lighting
- Day/night design
- Control elements
  - Keyboard language and handwriting recognition
  - Sensitivity of the touchpad
  - Sensitivity of the Touch Controls
- Voice Control System
- Sound
  - Entertainment
  - Navigation and traffic announcements
  - Telephone
  - Voice amplification to the rear
- Connectivity
  - Wi-Fi, Bluetooth®, NFC
- Time & date
- Language
- Units for distance

- Software updates
- Data import/export
- PIN protection
- System Reset

#### Information on important system updates

Important system updates may be necessary for the security of your multimedia system's data. Install these updates, or else the security of your multimedia system cannot be ensured.

A system update consists of three steps:

- Downloading or copying of the data required for installation
  - Installation of the downloaded system update
  - Activation of the downloaded system update by restarting the system
- ⓘ If automatic software updates are activated, the system updates will be downloaded automatically.

The multimedia system provides a message when a system update is available.

You have the following selection options:

- **Accept and Install**

The system update will be downloaded in the background.

- **Information**

Information about the pending system update is displayed.

- **Later**

The system update can be downloaded manually at a later time.

#### **Deep system updates**

Deep system updates access vehicle or system settings and can therefore only be carried out when the vehicle is stationary and the ignition is switched off.

If the download of a deep system update is completed and the downloaded system update is ready for installation, you will be informed of this after the next ignition cycle, for example.

- ⓘ Park the vehicle safely in a suitable location before starting the installation.

Requirements for the installation:

- The ignition is switched off.
- Notes and warnings have been read and accepted.
- The electric parking brake is applied.

If all requirements have been fulfilled, the downloaded system update is installed. The multimedia system cannot be operated while the downloaded system update is being installed and vehicle functions are restricted.

If errors should occur during the installation, the multimedia system automatically attempts to restore the previous version. If restoration of the previous version is not possible, a symbol appears on the media display. Consult a qualified specialist workshop to resolve the problem.

### Setting up a Wi-Fi hotspot

Requirements:

- **To set up the Wi-Fi connection of the multimedia system with external hotspots:** there is no communication module installed.

- The device to be connected supports at least one of the types of connection described.

Multimedia system:

→  » Settings » System  
» Wi-Fi & Bluetooth

### Activating/deactivating Wi-Fi

- ▶ Select **Wi-Fi**.

### Connecting the multimedia system with an external hotspot using Wi-Fi

The type of connection established must be selected on the multimedia system and on the device to be connected.



- ⓘ The connection procedure may differ depending on the device. Follow the instructions that are shown in the display. Further information can be found in the manufacturer's operating instructions.

- ▶ Select **Internet Settings**.
- ▶ Select **Connect via Wi-Fi**.
- ▶ Select **Add Hotspot**.

### Connecting using a QR code

- ▶ Select the options  of the desired Wi-Fi network.
- ▶ Select **Connect using a QR code**.
- ▶ Scan the displayed QR code with the device to be connected.  
The Wi-Fi connection is established.

### Connecting using a security key

- ▶ Select the options  of the desired Wi-Fi network.
- ▶ Select **Connect Using Security Key**.
- ▶ Have the security key displayed on the device to be connected (see the manufacturer's operating instructions).
- ▶ Enter this security key on the multimedia system.
- ▶ Confirm the entry with .

### Connecting using a WPS PIN

- ▶ Select the options  of the desired Wi-Fi network.

- ▶ Select **Connect via WPS PIN Input**.  
The multimedia system generates an eight-digit PIN.
- ▶ Enter this PIN on the device to be connected.
- ▶ Confirm the entry.

#### Connecting using a button

- ▶ Select the options  of the desired Wi-Fi network.
- ▶ Select **Connect via WPS PBC**.
- ▶ Select "Connect via WPS PBC" in the options on the device to be connected (see the manufacturer's operating instructions).
- ▶ Press the WPS button on the device to be connected.
- ▶ Select **Continue** in the multimedia system.

#### Activating automatic connection

- ▶ Select **Connect via Wi-Fi**.
- ▶ Select the options  of the desired Wi-Fi network.
- ▶ Activate **Permanent Internet Connection**.

#### Connecting with a known Wi-Fi

- ▶ Select **Connect via Wi-Fi**.
- ▶ Select a Wi-Fi network.  
The connection is established again.

#### Configuring the multimedia system as a Wi-Fi hotspot for external devices

The type of connection established depends on the device to be connected. The function must be supported by the multimedia system and by the device to be connected. The type of connection established must be selected on the multimedia system and on the device to be connected.

- ▶ Select **Vehicle Hotspot**.
- ▶ Select **Connect Device to Vehicle Hotspot**.

#### Connecting using WPS PIN generation

- ▶ Select **Connect via WPS PIN Generation**.
- ▶ Enter the PIN shown in the media display on the device to be connected and confirm.

#### Connecting using WPS PIN entry

- ▶ Select **Connect via WPS PIN Input**.

- ▶ Enter the PIN that is shown on the external device's display on the multimedia system.

#### Connecting using a button

- ▶ Select **Connect via WPS PBC**.
- ▶ Press the push button on the device to be connected (see the manufacturer's operating instructions).
- ▶ Select **Continue**.

#### Connecting using a security key

- ▶ Select **Connect Device to Vehicle Hotspot**.  
A security key is displayed.
- ▶ Select the vehicle from the device to be connected. The vehicle is displayed with the **DIRECT-MBUX XXXXX** network name.
- ▶ Enter the security key which is shown in the media display on the device to be connected.
- ▶ Confirm the entry.

#### Connecting using NFC

- ▶ Select **Connect via NFC**.
- ▶ Activate NFC on the mobile device (see the manufacturer's operating instructions).

- ▶ Hold the device to be connected at the vehicle's NFC interface.
- ▶ Select **Finished**.  
The mobile device is now connected to the multimedia system hotspot via NFC.

### Generating a new security key

- ▶ Select **Vehicle Hotspot**.
- ▶ Select **Generate Security Key**.  
A connection will be established with the newly created security key.
- ▶ **To save a security key:** select **Save**.  
When a new security key is saved, all existing Wi-Fi connections are then disconnected. If the Wi-Fi connections are being re-established, the new security key must be entered.

### System language

#### Notes on the system language

This function allows you to determine the language for the menu displays and the navigation announcements. The selected language affects the characters available for entry. The navigation announcements are not available in all languages.

If a language is not available, the navigation announcements will be in English.

#### Setting the system language

Multimedia system:

▶ ▶ ▶  ▶▶ Settings ▶▶ System  
▶▶  Language

- ▶ Set the language.

**i** If you are using Arabic map data, the text information can also be shown in Arabic on the navigation map. To do so, select العربية as the language from the language list. Navigation announcements are then also made in Arabic.

#### Resetting the multimedia system (reset function)

**⚠ WARNING** Risk of accidents due to failure of multimedia display functions

While the multimedia system is being reset, its functions such as the rear view camera are not available.

- ▶ Only reset the multimedia system when the vehicle is stationary.

Multimedia system:

▶ ▶ ▶  ▶▶ Settings ▶▶ System ▶▶ Reset

Personal data is deleted, for example:

- Station presets
  - Connected mobile phones
  - Vehicles with rear telephony: handset connection
  - Individual user profiles
- i** The guest profile is reset when the settings are restored to the factory settings.
- i** Vehicles with rear telephony: The handset must be in the cradle while the system is reset.

A prompt appears again asking whether you really wish to reset.

- ▶ Select **Yes**.  
The multimedia system is reset to the factory settings. If you have set a PIN for your system, this will also be reset.



## Navigation

### Notes on navigation

#### Route guidance with augmented reality

- ⚠ WARNING** Risk of accident and injury as a result of distraction, incorrect depiction or wrong interpretation of the display

The camera image of the augmented reality display is not suitable as a guide for driving.

- ▶ Always keep an eye on the actual traffic situation.
- ▶ Avoid extended observation of the camera image.

- ⚠ WARNING** Risk of accident and injury due to imprecise positioning of additional information

The additional information from the augmented reality display may be inaccurate and is not a substitute for observing and assessing the actual driving situation.

- ▶ Always keep an eye on the actual traffic situation when carrying out all driving maneuvers.

### Switching navigation on

Multimedia system:

→  → **Navigation** (Navigation)

- ▶ Alternatively: press the  button.  
The map shows the vehicle's current position.  
The navigation menu is shown.  
The navigation menu is hidden if route guidance is active.
- ▶ **To show:** tap on the touchscreen.  
The menu is hidden automatically.

## Navigation overview

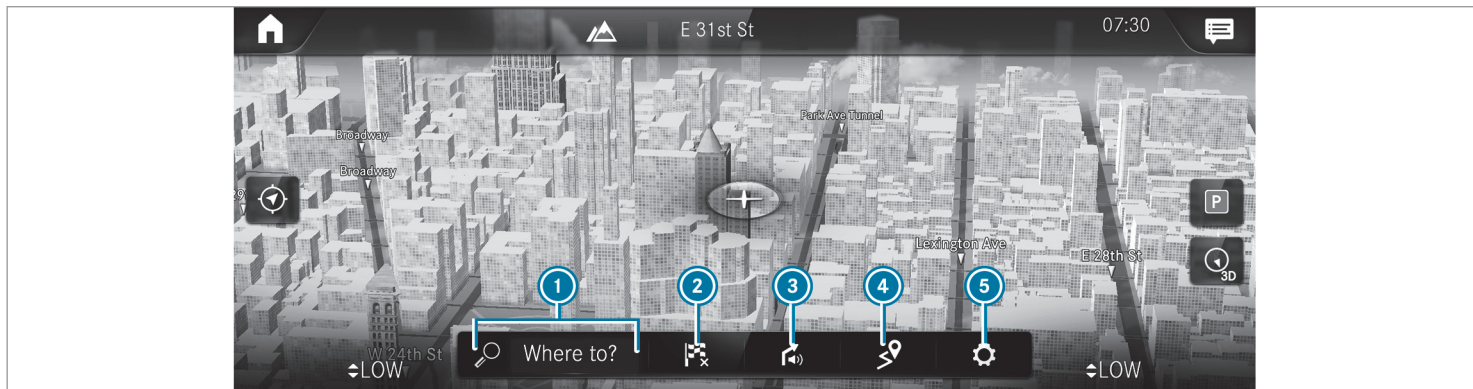

Example: digital map with navigation menu

- ① Enters a POI or address and additional destination entry options
- ② Cancels active route guidance
- ③ Repeats a navigation announcement and switch navigation announcements on or off

- ④ **ON THE WAY** menu with **Route Overview**, **Alternative Routes** and **Report Traffic Incident (Car-to-X)**  
**TRAFFIC** menu with **Traffic Announcements**, **Area Alerts** and **Live Traffic Subscription Info**  
Displays **Route List**

**POSITION** menu with **Save Position** and **Compass**

- ⑤ Quick access for **Traffic**, **Parking** and **Highway Information** as well as options for **View**, **Announcements** and **Route via Advanced**

## Entering a destination

Multimedia system:

→ Home → Navigation → Where to?



- ① Federal state or province in which the vehicle is located
- ② Enters a POI or address
- ③ List with additional destination entry options
- ④ Deletes an entry

- ⑤ **OK** Confirms an entry
- ⑥ Switches to handwriting recognition
- ⑦ Enters a space
- ⑧ Switches to voice input
- ⑨ Sets the written language

- ⑩ Switches to digits, special characters and symbols
- ▶ Enter the destination in ②. The entries can be made in any order.

The following entries can be made, for example:

- City, street, house number
- Street, city
- ZIP code
- POI name or POI category, e.g. [Parking](#)
- Contact name

▶ Select a search result in list ③.

▶ Calculate the route (→ page 240).

① You can find further information about destination entry, e.g. 3 word addresses, in the Digital Operator's Manual.

### Changing country

▶ Select the indicator for federal state or province ①.

▶ Select the federal state or the province in ①.

▶ Enter the country indicator.

▶ Select the country on list ③.

▶ Select the federal state or the province from list ③.

### Using online search

① Requirements: the media display shows an Internet connection with a double-arrow symbol in the status line.

Destination entry uses online map services. If the on-board search finds no suitable destinations or if you change countries, the online search is available.

For the destination you can enter an address, a POI or a three-word address.

▶ Enter the destination in input line ②.

▶ Select the destination in the list.

or

▶ Select country indicator ①.

▶ Select the provider for the online service from the countries list.

▶ Enter the destination in input line ②.

▶ Select the destination in the list.

### Calculating a route and using settings for route guidance

#### Requirements:

- The destination has been entered.
- The destination address is shown.

Multimedia system:

→  → [Navigation](#)

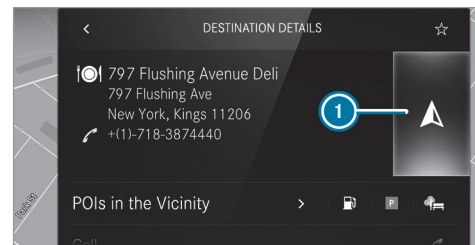

①  No route yet.

 A route has been mapped.

- ▶ Select . The route to the destination is calculated. Route guidance begins.



or

- ▶ Select .
- ▶ Select **Set as Waypoint**. The destination address is set as the next intermediate destination.

or

- ▶ Select **Start New Route Guidance**. The destination address is set as the new destination. The previous destination and the intermediate destinations are deleted. Route guidance to the new destination begins.

### Selecting route settings

- ▶ Select .
- ▶ Select **Advanced**.
- ▶ Select **Route**.
- ▶ Select the route type.
- ▶ Take traffic information into consideration with **Dynamic Route Guidance** .

- ▶ Select route options with **Avoid Options**.
- ▶ Activate **Suggest Alternative Route**. Alternative routes are calculated for every route.
- ▶ Activate **Activate Commuter Route**. If the requirements are met, the multimedia system automatically detects that the vehicle is on a commuter route. Route guidance begins without voice output.

### Activating route guidance with augmented reality

- ▶ During route guidance, tap on the camera symbol on the media display. The camera image will be shown instead of the navigation map before a turning maneuver and will show additional information.
- ▶ **To return to the navigation map:** tap on the camera symbol again.

### Displaying additional information in the camera image

- ▶ Select .
- ▶ Select **Advanced**.
- ▶ Select **Augmented Reality**.

- ▶ Activate **Street Names** and **House Numbers**. During route guidance, street names and house numbers are shown in the camera image.

### Using map functions

Multimedia system:

▶▶ **Navigation**

### Setting the map scale

- ▶ **To zoom in:** tap twice quickly with one finger on the media display.
- ▶ **To zoom out:** tap with two fingers on the media display.

### Moving the map

- ▶ Move one finger in any direction on the touchscreen.
- ▶ **To reset the map to the current vehicle position:** press  briefly.

### Selecting map orientation

- ▶ Tap repeatedly on the  compass symbol on the map.  
The view changes in the sequence **3D**, **2D Heading Up** to **2D North Up**.

### Switching highway information on/off

- ▶ Select .
- ▶ Switch **Highway Information** on or off.

### Using services

#### Requirements:

- There is an Internet connection.
- Mercedes me connect is available.
- You have set up a user account in the Mercedes me Portal.
- The vehicle is connected to a user account and you have accepted the conditions of use for the service.  
Further information can be found at: <https://www.mercedes.me>
- The service is available.

- The service has been activated at an authorized Mercedes-Benz Center.
- The following additional conditions apply to the Parking service:
  - The navigation services option is available, subscribed to and activated in the Mercedes me Portal.
  - The parking service is within the scope of the navigation service.

Multimedia system:

  **Navigation**

#### Displaying the traffic situation with Live Traffic Information

- ▶ Select .
- ▶ Activate **Traffic**.
- ▶ Select **Advanced**.
- ▶ Select **View**.
- ▶ Select **Map Elements**.

- ▶ **Traffic Incidents**, **Free Flowing Traffic** and **Delay**: switch on.

If traffic information has been received, then traffic incidents such as roadworks, road blocks, local area reports (e.g. fog) and warning messages are displayed.

The traffic delay is displayed for the current route. Traffic delays lasting one minute or longer are taken into consideration.

#### Displaying hazard warnings with Car-to-X-Communication

If hazard warnings are available these can be shown as symbols on the map. The display depends on the settings for the **Traffic** and **Traffic Incidents** options.

- ▶ Set the options.  
If **Traffic** is switched off and **Traffic Incidents** is switched on, the symbols are shown on the prospective route.

#### Displaying weather information and other map contents

- ▶ Select .
- ▶ Select **Advanced**.

- ▶ Select **View**.
- ▶ Select **Map Elements**.
- ▶ Scroll up and show the **ONLINE MAP CONTENT** category.
- ▶ Switch on a service, e.g. **Weather**.  
Current weather information is displayed on the navigation map, e.g. temperature or cloud cover.

### Parking service

**!** **NOTE** Damage to the vehicle due to not observing the maximum permitted headroom clearance

If the vehicle height is greater than the maximum permitted headroom clearance, the roof and other parts of the vehicle may be damaged.

- ▶ Observe the signposted headroom clearance.
- ▶ If the vehicle height is greater than the permitted headroom clearance, do not enter.

- ▶ Observe the changed vehicle height with add-on roof equipment.

**!** **NOTE** Before selecting the parking option

The data is based on information provided by the respective service provider.

Mercedes Benz accepts no liability for the accuracy of the information provided relating to the parking garage/parking lot.

- ▶ Always observe the local Information and conditions.

**i** This service is not available in all countries.

- ▶ Select  and activate **Parking**.
- ▶ Tap on **P** in the map.
- ▶ Select a parking option.  
The map shows the parking options in the vicinity.  
The following information is displayed (if available):
  - Destination address, distance from current vehicle position and arrival time

- Information on the parking garage/parking lot, for example:
    - Opening times
    - Parking charges
    - Current occupancy
    - Maximum parking time
    - **Maximum access height**  
The maximum access height shown by the parking service does not replace the need for observation of the actual circumstances.
  - Available payment options (Mercedes pay, coins, bank notes, cards)
  - Details on parking tariffs
  - Number of available parking spaces
  - Payment method (e.g. at the parking meter)
  - Services/facilities at the parking option
  - Telephone number
- ▶ Calculate the route (→ page 240).

### Notes on the dashcam

#### **NOTE** Before using the dashcam

You are legally responsible for operation and use of the dashcam functions. The legal requirements relating to operation and use of the dashcam can vary depending on the country in which the dashcam is operated. Therefore, observe the legal requirements, in particular the data protection regulations, in your country.

For this reason, before using the dashcam inform yourself about the regulation details for the respective country.

This function is not permitted in all countries.

- ▶ Observe the country-specific regulations.

### Selecting a USB device for a video recording with the dashcam

#### Requirements:

- At least one USB device is connected with the multimedia system .

Multimedia system:

➔  ➔ Mercedes me & Apps  
➔➔ Dashcam

- ▶ Select the USB device.

**i** When USB devices contain multiple partitions, recorded video files are not always displayed in the recording list. Mercedes-Benz recommends that you use USB devices with one partition.

### Starting or stopping video recording with the dashcam

#### Requirements:

- A USB device is connected with the multimedia system .
- The vehicle is switched on.

Multimedia system:

➔  ➔ Mercedes me & Apps  
➔➔ Dashcam

- ▶ If several USB devices are connected with the multimedia system, select a USB device (→ page 244).

- ▶ Select the **Individual Recording** or **Loop Recording** recording mode.

If **Individual Recording** is selected and the memory is full the recording stops.

If **Loop Recording** has been selected, several short video files are recorded. When the memory limit is reached, the oldest video file is deleted and recording is continued automatically.

- ▶ **To start:** select **Start Recording**.

The length of the recording is shown. The **Please do not remove the storage medium** message appears. The video file is stored on the USB device.

- ▶ **To end:** select **End Recording**.



A report may appear in the following cases:

- For the **Individual Recording** recording mode: the memory is full or there are only a few minutes recording time available. The video recording stops or will be stopped imminently. Change the USB device or delete a video file.
- If a video recording has started and a national border is detected, the **National Border Crossed. Please observe the country-specific regulations on video recording.** message appears.  
This function is not available in all countries.
- The camera is not functional, the **Camera Unavailable** message appears.  
Have the camera checked in an authorized Mercedes-Benz Center.

## Telephone

### Telephony

#### Notes on telephony

- ⚠ **WARNING** Risk of distraction from operating integrated communication equipment while the vehicle is in motion

If you operate communication equipment integrated in the vehicle when driving, you could be distracted from the traffic situation. This could also cause you to lose control of the vehicle.

- ▶ Only operate this equipment when the traffic situation permits.
- ▶ If you cannot be sure of this, stop the vehicle whilst paying attention to road and traffic conditions and operate the equipment with the vehicle stationary.

- ⚠ **WARNING** Risk of an accident from operating mobile communication equipment while the vehicle is in motion

Mobile communications devices distract the driver from the traffic situation. This could also cause the driver to lose control of the vehicle.

- ▶ As the driver, only operate mobile communications devices when the vehicle is stationary.
- ▶ As a vehicle occupant, only use mobile communications devices in the areas intended for this purpose, e.g. in the rear passenger compartment.

You must observe the legal requirements for the country in which you are currently driving when operating mobile communication equipment in the vehicle.

- ⚠ **WARNING** Risk of injury due to objects being stowed incorrectly

If objects in the vehicle interior are stowed incorrectly, they can slide or be thrown around

and hit vehicle occupants. In addition, cup holders, open stowage spaces and mobile phone receptacles cannot always retain all objects within.

There is a risk of injury, particularly in the event of sudden braking or a sudden change in direction.

- ▶ Always stow objects so that they cannot be thrown around in such situations.
- ▶ Always make sure that objects do not protrude from stowage spaces, parcel nets or stowage nets.
- ▶ Close the lockable stowage spaces before starting a journey.
- ▶ Always stow and secure heavy, hard, pointed, sharp-edged, fragile or bulky objects in the trunk/cargo compartment.

Observe the additional information on stowing mobile communications devices correctly:

- Loading the vehicle (→ page 97)

**Bluetooth® connection:**

The menu view and the available functions in the telephone menu are in part dependent on the Bluetooth® profile of the connected mobile phone. Full functionality is only available if the mobile phone supports both of the following Bluetooth® profiles:

- PBAP (Phone Book Access Profile)
  - The contacts on the mobile phone are shown automatically on the multimedia system.
- MAP (Message Access Profile)
  - The mobile phone message functions can be used on the multimedia system.

Irrespective of this, Bluetooth® audio functionality can be used with any mobile radio unit.

For information on the range of functions of the mobile radio unit to be connected, see the manufacturer's operating instructions.

**Network connection:**

The following cases can lead to the call being disconnected while the vehicle is in motion:

- You switch into a transmission/reception station, in which no communication channel is free.
- The SIM card used is not compatible with the network available
- A mobile phone with "Twincard" is logged into the network with the second SIM card at the same time

The multimedia system supports calls in HD Voice® for improved speech quality. A requirement for this is that the mobile phone and the mobile phone network provider of the person you are calling support HD Voice®.

Depending on the quality of the connection, the voice quality may fluctuate.

Further information can be obtained from an authorized Mercedes-Benz Center or at: <https://www.mercedes-benz.com/connect>

## Telephone menu overview

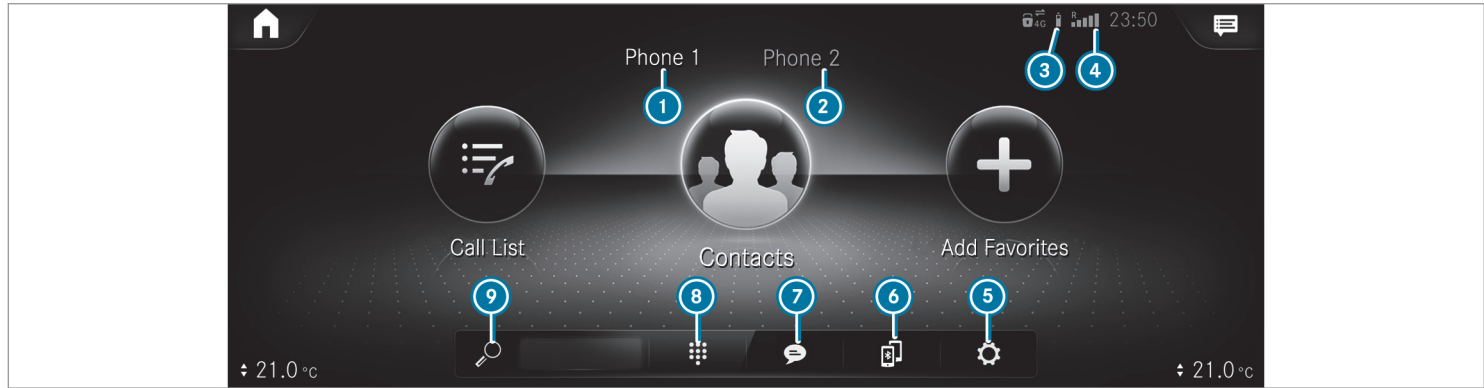

- ① Bluetooth® device name of the currently connected mobile phone/of the mobile phone
- ② Bluetooth® device name of the currently connected mobile phone/of the mobile phone (two phone mode)
- ③ Battery status of the connected mobile phone
- ④ Signal strength of the mobile phone network
- ⑤ Options

- ⑥ Device manager
- ⑦ Messages
- ⑧ Numerical pad
- ⑨ Contact search

**Telephony operating modes overview**

Depending on your equipment, the following telephony operating modes are available:

- A mobile phone is connected to the multimedia system via Bluetooth®.

- Two mobile phones are connected with the multimedia system via Bluetooth® (two phone mode).
  - You can use all the functions of the multimedia system with the mobile phone in the foreground.
  - You can receive incoming calls and messages with the mobile phone in the background.

You can interchange the mobile phone in the foreground and background.

### Connecting a mobile phone

#### Requirements:

- Bluetooth® is activated on the mobile phone (see the manufacturer's operating instructions).
- Bluetooth® is activated on the multimedia system.

Multimedia system:



#### Searching for a mobile phone

- ▶ Select .
- ▶ Select **Connect New Device**.

#### Connecting a mobile phone



Authorization follows using secure simple pairing.

- ▶ Select a mobile phone.

A code is displayed in the multimedia system and on the mobile phone.
- ▶ If both codes match, confirm the code on the mobile phone.

#### Functions in the telephony menu

In the telephony menu you have the following functions, for example:

- Making calls, e.g.:
  -  Accept a call
  -  **End Call**
  -  **Create Confer. Call**
  - Accepting or rejecting a waiting call

- Managing contacts, e.g.:
  - Downloading mobile phone contacts
  - Managing the format of a contact's name
  - Saving a contact as a favorite
- Receiving and sending messages, e.g.:
  - Using the read-aloud function
  - Dictating a new message

## Mercedes me app

### Mercedes me calls

#### Making a call via the overhead control panel

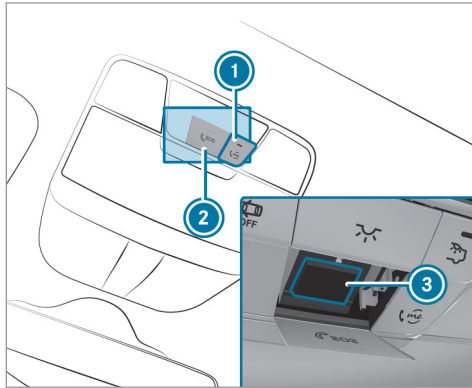

- ① me button for service or information calls
- ② SOS button cover
- ③ SOS button (emergency call system)

#### Making a Mercedes me call

- ▶ Press me button ①.

#### Making an emergency call

- ▶ To open the cover of SOS button ②, press it briefly.
- ▶ Press and hold SOS button ③ for at least one second.

If a Mercedes me call is active, an emergency call can still be triggered. This has priority over all other active calls.

#### Information about the Mercedes me call using the me button

A call to the Mercedes-Benz customer center has been initiated via the me button in the overhead control panel or the multimedia system (→ page 249).

Using the voice dialog system you access the desired service:

- Accident and Breakdown Management
- Mercedes-Benz customer center for general information about the vehicle

You can find information on the following topics:

- Activation of Mercedes me connect
- Operating the vehicle
- Nearest authorized Mercedes-Benz Center
- Other products and services from Mercedes-Benz

Data is transferred during the connection to the Mercedes-Benz customer center (→ page 251).

#### Calling the Mercedes-Benz customer center using the multimedia system

##### Requirements:

- Access to a mobile phone network is available.
- The contract partner's mobile network coverage is available in the respective region.
- The vehicle must be switched on so that vehicle data can be transferred automatically.

Multimedia system:



▶ Call **Mercedes me connect**.

After confirmation, the multimedia system sends the required vehicle data. The data transfer is shown in the media display.

Then, you can select a service and be connected to a specialist at the Mercedes-Benz customer center.

### Calling the Mercedes-Benz Customer Center after automatic accident or breakdown detection

#### Requirements:

- The vehicle has detected an accident or breakdown situation.
- The vehicle is stationary.
- The hazard warning lights are switched on.

ⓘ This function is not available in all countries.

The vehicle can detect accident or breakdown situations under certain circumstances.

In the event an accident or breakdown is detected, the emergency guide shows safety notes in the multimedia system display.

After quitting the emergency guide display on the multimedia system, a prompt appears asking whether you would like to get support from the Mercedes-Benz Customer Center.

▶ Select **Call**.

- The vehicle data is sent automatically (→ page 252).
- The Mercedes-Benz Customer Center takes your call and organizes the breakdown and accident assistance.

You may be charged for these services.

ⓘ Depending on the severity of the accident, an automatic emergency call can be initiated. This has priority over all other active calls.

ⓘ In addition, if the Mercedes me connect service "Telediagnosics" is active, a similar prompt can appear after a delay in the event of a breakdown. If you are already in contact with the Mercedes-Benz Customer Center or

have already received support, this prompt can be ignored or declined.

ⓘ If you answer the prompt for support from the Mercedes-Benz Customer Center with **Later**, the message will be hidden and appear again later.

The prompt triggered by the Mercedes me connect service "Telediagnosics", can either be confirmed or declined. After being declined, this will not be shown again.

### Arranging a service appointment via a Mercedes me call

If you have activated the maintenance management service, relevant vehicle data is transferred automatically to the Mercedes-Benz customer center. You will then receive individual recommendations regarding the maintenance of your vehicle.

Regardless of whether you have consented to the maintenance management service, the multimedia system reminds you after a certain amount of time that a service is due. A prompt appears asking if you would like to make an appointment.

▶ **To arrange a service appointment:** select **Call**. After your agreement, the vehicle data is transferred and the Mercedes-Benz customer center takes your preferred appointment date. The information is then sent to your desired service outlet.

This will contact you to confirm the appointment and if necessary consult about the details.

ⓘ If you select **Later** after the service message appears, the message is hidden and reappears at a later time.

#### **Transferred data during a Mercedes me call**

When you make a service call via Mercedes me, data is transmitted. This enables targeted advice and a smooth service.

The following requirements must be fulfilled for the transfer of the data:

- The vehicle is switched on.
- The required data transfer technology is supported by the mobile phone network provider.
- The quality of the mobile connection is sufficient.

Multi-stage transfer depends on the following factors:

- Reason for the initiation of the call
- The available mobile phone transmission technology.
- The activated Mercedes me connect services.
- The service selected in the voice control system.

#### **Data transfer if Mercedes me connect services are not activated**

If no Mercedes me connect services are activated, the following data is transferred:

- Vehicle identification number
- Time of the call
- Reason for the initiation of the call
- Country indicator of the vehicle
- Set language for the multimedia system
- Telephone number of the communication platform installed in the vehicle

If a call is made for a service appointment via the service reminder, the following data is also transmitted:

- Current mileage and maintenance data

If a call is made after automatic accident or breakdown detection using the multimedia system, the following data is also transmitted:

- Current mileage and maintenance data
- Current vehicle location

If Accident and Breakdown Management is called via the voice control system, the following data can also be called up from the vehicle by the Mercedes-Benz customer center:

- Current vehicle location

#### **Data transfer if Mercedes me connect services are activated**

An overview of the data transmitted can be found in the respective terms of use for Mercedes me connect services. These can be obtained in the Mercedes me portal: <https://me.secure.mercedes-benz.com>

### Data processing

The data transmitted within the scope of the call is deleted from the processing system after the call is finished, in so far as this data is not being used for other activated Mercedes me connect services.

The incident-specific data is processed and stored in the Mercedes-Benz customer center and, if required to process the incident, forwarded to the service partner authorized by the Mercedes-Benz customer center. Please take note of the data protection information on the Mercedes me Internet page <https://www.mercedes.me> or in the recorded message immediately after calling the Mercedes-Benz customer center.

 The recorded message is not available in every country.

### Mercedes me connect

#### Information on Mercedes me connect

Mercedes me connect consists of multiple services.

You can use the following services via the multimedia system and the overhead control panel, for example:

- Accident and Breakdown Management (me button or situation-dependent display in the multimedia system)
- Mercedes-Benz emergency call system (automatic emergency call and SOS button)

The Mercedes me connect Accident and Breakdown Management and the Mercedes-Benz emergency call center are available to you around the clock.

The me button and the SOS button can be found on the vehicle's overhead control panel (→ page 249).

You can also call the Mercedes-Benz customer center using the multimedia system (→ page 249).

Please note that Mercedes me connect is a Mercedes-Benz service. In emergencies, first call the national emergency services using the standard national emergency service telephone numbers. In emergencies, you can also use the

Mercedes-Benz emergency call system (→ page 256).

Observe the conditions of use for Mercedes me connect and other services. These can be obtained in the Mercedes me Portal: <https://me.secure.mercedes-benz.com>

Further information about Mercedes me connect services can be obtained in the Mercedes me Portal: <https://me.secure.mercedes-benz.com>

#### Information on Mercedes me connect Accident and Breakdown Management

The Accident and Breakdown Management can include the following functions:

- Supplement to the Mercedes-Benz emergency call system (→ page 256)  
If necessary, the contact person at the Mercedes-Benz emergency call center forwards the call to Mercedes me connect Accident and Breakdown Management. Forwarding the call is however not possible in all countries.
- Breakdown assistance by a technician on location and/or the towing away of the vehicle



to the nearest authorized Mercedes-Benz Center

You may be charged for these services.

- Addition to the emergency guide after automatic accident or breakdown detection (→ page 250)

In the event of a breakdown or accident, further vehicle data is sent which enables optimal support by the Mercedes-Benz customer center and the authorized service partner or breakdown assistance.

- Addition to the Mercedes me connect service Telediagnosics

With the Telediagnosics function, specific wear and failure reports are recorded by the service provider, in so far as these can be clearly interpreted and are available through the monitoring of components that are subject to diagnostics.

If your vehicle detects a breakdown or threat of a breakdown, you may be prompted via the multimedia system to contact the Mercedes-Benz customer center for further help. This

prompt in the multimedia system only appears when the vehicle is stationary.

- ⓘ These services are subject to technical restrictions such as the mobile phone coverage, mobile network quality and the ability of the processing systems to interpret the transferred data. In some circumstances, this can result in delays or the failure of the information to appear in the multimedia system.

More information about Mercedes me connect services can be obtained in the Mercedes me Portal: <https://me.secure.mercedes-benz.com>

#### Data transferred during Mercedes me connect call services

The data transferred during a Mercedes me connect call depends on:

- The reason for initiation of the call
- The service that is selected in the voice control system
- The activated Mercedes me connect services

You can find out which data is transferred when using the services in the currently valid Mercedes

me connect terms of use and the data protection information for Mercedes me connect. You can find these in your Mercedes me user account.

#### Overview of the Mercedes me & Apps menu

When you log in with a user account to the Mercedes me Portal, then services and offers from Mercedes-Benz will be available to you.

For more information consult an authorized Mercedes-Benz Center or visit the Mercedes me portal: <https://me.secure.mercedes-benz.com>

- ⓘ Make sure you always keep the Mercedes me apps updated.

You can call up the menu using **Mercedes me & Apps** in the multimedia system.

In the **Mercedes me & Apps** menu, the following options can be available:

- Connecting the vehicle with the **Mercedes me** user account
- Deleting a connection between a **Mercedes me** user account and the vehicle
- Calling up the Mercedes me services

- Calling up apps such as, In-Car Office or the web browser depending on availability

### Web browser overview

The web browser is started using the **Mercedes me & Apps** menu.

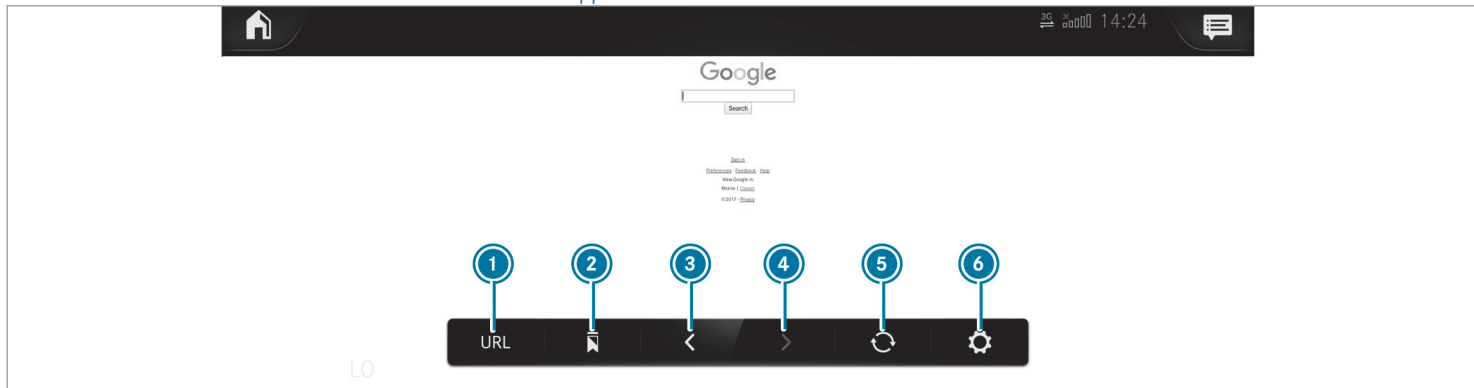

- 1 URL entry
- 2 Bookmarks
- 3 Web page, back
- 4 Web page, forwards
- 5 To refresh/stop
- 6 Options

**i** Websites cannot be shown while the vehicle is in motion.

### Overview of smartphone integration

With Smartphone Integration, you can use certain functions on your mobile phone via the multimedia system display.

Only one mobile phone at a time can be connected via Smartphone Integration to the multimedia

system. Also for use with two phone mode with smartphone integration, only one additional mobile phone can be connected using Bluetooth® with the multimedia system.

The full range of functions for Smartphone Integration is only possible with an Internet connection. The appropriate application must be downloaded on the mobile phone to use Smartphone Integration. The mobile phone must be switched on and connected to a USB port with the  symbol on the multimedia system using a suitable cable.

#### Apps for Smartphone Integration

- Apple CarPlay®
- Android Auto

 For safety reasons, the first activation of Smartphone Integration on the multimedia system must be carried out when the vehicle is stationary and the parking brake is applied.

You can start Apple CarPlay® or Android Auto from the device manager.

 Mercedes-Benz recommends disconnecting the connecting cable only when the vehicle is stationary.

#### Overview of transferred vehicle data

When using Smartphone Integration, certain vehicle data is transferred to the mobile phone. This enables you to get the best out of selected mobile phone services. Vehicle data is not directly accessible.

The following system information is transmitted:

- Software release of the multimedia system
- System ID (anonymized)

The transfer of this data is used to optimize communication between the vehicle and the mobile phone.

To do this, and to assign several vehicles to the mobile phone, a vehicle identifier is randomly generated.

This has no connection to the vehicle identification number (VIN) and is deleted when the multimedia system is reset (→ page 236).

The following driving status data is transmitted:

- Transmission position engaged
- Distinction between parked, standstill, rolling and driving
- Day/night mode of the instrument cluster
- Drive type

The transfer of this data is used to alter how content is displayed to correspond to the driving situation.

The following position data is transmitted:

- Coordinates
- Speed
- Compass direction
- Acceleration direction

This data is used by the mobile phone to improve the accuracy of the navigation (e.g. for continuation in a tunnel).

## Mercedes-Benz emergency call system

### Information on the Mercedes-Benz emergency call system

Your vehicle is equipped with the Mercedes-Benz emergency call system ("eCall"). This feature can help save lives in the event of an accident. eCall in no way replaces assistance provided from dialing 911.

Mercedes-Benz eCall only functions in areas where mobile phone coverage is available from the wireless service providers. Insufficient network coverage from the wireless service providers may result in an emergency call not being transmitted.

eCall is a standard feature in your Mercedes-Benz vehicle. In order to function as intended, the system relies on the transmission of data detailed in the "Mercedes-Benz emergency call system data transmission" section that follows (→ page 258).

To disable eCall, a customer must visit an authorized Mercedes-Benz Service department to deactivate the vehicle's communication module.

**Deactivation of this module prevents the activation of any and all Mercedes me connect services. After the deactivation of eCall, automatic emergency call and manual emergency call will not be available.**

The vehicle must be switched on before an automatic emergency call can be made.

- ❗ eCall is activated at the factory.
- ❗ eCall can be deactivated by an authorized Mercedes-Benz dealer. Please note that in the event ownership of the vehicle is transferred to another owner in its deactivated state, eCall will remain deactivated unless the new owner visits an authorized Mercedes-Benz dealership to reactivate the system.

### Overview of the Mercedes-Benz emergency call system

eCall can help to reduce the time between an accident and the arrival of emergency services at the site of the accident. It helps locate an accident site in places that are difficult to access. However, even if a vehicle is equipped with eCall, this does not mean the system is ON. As such,

eCall does not replace dialing 911 in the event of an accident.

An emergency call can be made automatically or manually.

Only make emergency calls if you or others are in need of rescue. Do not make an emergency call in the event of a breakdown or a similar situation.

#### Messages on the display

SOS NOT READY: the vehicle is not on or eCall not available.

During an active emergency call, <schar> appears in the display.

You can find more information on the regional availability of eCall at: <https://www.mercedes-benz-mobile.com/extra/ecall/>

- ❗ If there is a malfunction in the Mercedes-Benz emergency call system (e.g. a malfunction with the speaker, microphone, airbag, SOS button), a corresponding message appears on the display in the instrument cluster.

### Triggering an automatic Mercedes-Benz emergency call

#### Requirements:

- The vehicle is switched on.
- The starter battery is sufficiently charged.

The Mercedes-Benz emergency call system triggers an emergency call automatically in the following cases:

- After activation of the restraint systems such as airbags or Emergency Tensioning Devices after an accident
- After an emergency stop automatically initiated by Active Emergency Stop Assist

The emergency call has been made:

- A voice connection is made to the Mercedes-Benz emergency call center.
- A message with accident data is transmitted to the Mercedes-Benz emergency call center.

The Mercedes-Benz emergency call center can transmit the vehicle position data to one of the emergency call centers.

The SOS button in the overhead control panel flashes until the emergency call is finished.

It is not possible to immediately end an automatic emergency call.

If no connection can be made to the emergency services either, a corresponding message appears in the media display.

- ▶ Dial the local emergency number on your mobile phone.

If an emergency call has been initiated:

- Remain in the vehicle if the road and traffic conditions permit you to do so until a voice connection is established with the emergency call center operator.
- Based on the call, the operator decides whether it is necessary to call rescue teams and/or the police to the accident site.
- If no vehicle occupant answers, an ambulance is sent to the vehicle immediately.

### Triggering a manual Mercedes-Benz emergency call

- ▶ **To use the SOS button in the overhead control panel:** press and hold the SOS button for at least one second (→ page 249).
- ▶ **To use voice control:** use the Voice Control System voice commands .

The emergency call has been made:

- A voice connection is made to the Mercedes-Benz emergency call center.
- A message with accident data is transmitted to the Mercedes-Benz emergency call center. The Mercedes-Benz emergency call center can transmit the vehicle position data to one of the emergency call centers.
- Remain in the vehicle if the road and traffic conditions permit you to do so until a voice connection is established with the emergency call center operator.
- Based on the call, the operator decides whether it is necessary to call rescue teams and/or the police to the accident site.

If no connection can be made to the emergency services either, a corresponding message appears in the media display.

▶ Dial the local emergency number on your mobile phone.

#### Ending an unintentionally triggered manual Mercedes-Benz emergency call

▶ **Using the multifunction steering wheel:** select . Depress the button for several seconds.

#### Data transfer of the Mercedes-Benz emergency call system

---

In the event of an automatic or manual emergency call the following data is transmitted, for example:

- Vehicle's GPS position data
- GPS position data on the route (a few hundred meters before the incident) ()
- Direction of travel
- Vehicle identification number
- Vehicle drive type
- Number of people determined to be in the vehicle

- Whether Mercedes me connect is available or not
- Whether the emergency call was initiated manually or automatically
- Time of the accident
- Language setting on the multimedia system

Data transmitted is vehicle information. For any questions about the collection, use and sharing of the eCall system data, please contact MBUSA's Customer Assistance Center at 800-FOR-MERC.

For Canada, please contact MBC's Customer Assistance Center at 1-800-387-0100.









Customer requests for covered information should be submitted via the same channels.





For accident clarification purposes, the following measures can be taken up to an hour after the emergency call has been initiated:

- The current vehicle position can be determined.
- A voice connection to the vehicle occupants can be established.

## Radio &amp; media

## Overview of the symbols and functions in the media menu

Symbol	Designation	Function
	Play	Select to start or continue playback.
	Rest	Select to pause the playback.
	Repeat a track	Select to repeat the current track or the active playlist. <ul style="list-style-type: none"> <li>• Select once: the active playlist is repeated.</li> <li>• Select twice: the current track is repeated.</li> <li>• Select three times: the function is deactivated.</li> </ul>
	Random playback	Select to play back the tracks in random order.
	Skip forwards/back	Select to skip to the next or to the previous track.
	Options	Select to show additional options.
	Categories	Select to show or search through available categories (e.g. playback lists, albums, artists, etc.).
	Search	Select to search in the active menu. You can search for artists, genres or moods, for example.

Symbol	Designation	Function
	Settings	Select to make settings.
	Home	Select to return to the home screen.
	Messaging	Select to call up messaging.
	Full screen	Select to switch to full screen mode.

The following functions and settings are available in the media menu:

- Connecting external data storage media with the multimedia system (e.g. using USB or Bluetooth®)
- Playing back audio or video files

### Authorizing a Bluetooth® audio device for media playback

#### Requirements:

- Bluetooth® is activated on the multimedia system and audio equipment.

- The audio equipment supports the Bluetooth® audio profiles A2DP and AVRCP.
- The audio equipment is "visible" for other devices.

Multimedia system:



With Bluetooth® audio, you can play back music files from an external data storage medium, e.g. your smartphone, using the MBUX multimedia system.

- ▶ To play back audio files using the multimedia system, authorize the external data storage medium on the MBUX multimedia system.

#### Authorizing a new Bluetooth® audio device





- ▶ Select **Connect New Device**.
- ▶ Select an audio device. Authorization starts. A code is displayed on the multimedia system and on the mobile phone.
- ▶ If the codes are identical, confirm on the audio equipment.
- ▶ Select **Only as Bluetooth Audio Device**. The Bluetooth® audio equipment is connected with the multimedia system.







### Connecting previously authorized Bluetooth® audio equipment

- ▶ Select a Bluetooth® audio device from the list.  
The connection is being established.





### Overview of the symbols and functions in the radio menu

Symbol	Designation	Function
	Home	Select to return to the home screen.
	Messaging	Select to call up messaging.
	Skip forwards/back	Select to skip to the next or to the previous station.
	Settings	Select to have further options shown. Settings can be made to the following additional functions, for example: <ul style="list-style-type: none"> <li>• Navigation and traffic announcements</li> <li>• Frequency fix function</li> <li>• Radio additional text</li> <li>• Emergency warnings</li> </ul> The setting options are country-dependent.

Symbol	Designation	Function
HD	HD radio®	Select to switch the HD Radio® function on or off. This function is not available in all countries.
	Silent function	Select to switch off the sound.
	Store radio stations	Select to save a station in the presets.
	Station list	Select to have the station list shown.
	Search	Select to search in the active menu. You can search for artists, genres or moods, for example.

#### Additional functions of TuneIn radio

-  A relatively large volume of data can be transmitted when using TuneIn Radio.





Symbol	Designation	Function
	Settings	The following additional settings are available in the Tuneln Radio menu: <ul style="list-style-type: none"> <li>• Selecting stream</li> <li>• Logging on to or out of the Tuneln account</li> </ul>
	Favorites	Select during playback to save the station currently set as a favorite.
	Play/Pause	Select to start, stop or continue playback.
	Browse	Select to choose a category and then a radio station.

#### Additional functions of the satellite radio

SIRIUS XM<sup>®</sup> satellite radio offers more than 175 digital-quality radio channels providing 100% commercial-free music, sports, news and entertainment, for example. SIRIUS XM<sup>®</sup> satellite radio employs a fleet of high-performance satellites to

broadcast around the clock throughout the USA and Canada. The satellite radio program is available for a monthly fee. Information about this can be obtained from a Sirius XM<sup>®</sup> Service Center and at <https://www.siriusxm.com> (USA) or <https://www.siriusxm.ca> (Canada).

 Sirius, XM and all related marks and logos are trademarks of Sirius XM Radio Inc. and its subsidiaries. All other marks, channel names and logos are the property of their respective owners. All rights reserved.

Symbol	Designation	Function
	Settings	The following additional settings are available in the satellite radio menu: <ul style="list-style-type: none"> <li>• Activate child safety lock to lock channels with adult content</li> <li>• Set alarm programming for music and sport alerts</li> <li>• Create TuneMix lists to listen to music seamlessly</li> </ul>
	Playback control	Select to show the timeline. Tap any point on the timeline to skip forwards or back. Navigate to the end of the timeline to return to live mode.
	Play	Select to start or continue playback.
	Rest	Select to pause the playback.

Depending on the frequency band selected, different functions are available to you.

Select the desired frequency band in the radio menu head runner.

### [Calling up TuneIn Radio](#)

**Requirements:**

- The TuneIn Radio service is activated in the Mercedes me Portal.
- The data volume is available.  
Depending on the country, data volume may need to be purchased.
- A fast Internet connection for data transmission free of interference.

- ⓘ Data volume can be purchased **directly from a mobile phone network provider** via the Mercedes me Portal.
- ⓘ The functions and services are country-dependent. For more information, consult an authorized Mercedes-Benz Center.

Multimedia system:

 **Radio**

- ▶ Select **TuneIn Radio**.  
The TuneIn menu appears. The last station set starts playing.
- ⓘ The connection quality depends on the local mobile phone reception.

## Setting up satellite radio

### Requirements:

- Satellite radio equipment is available.
- Registration with a satellite radio provider has been completed.
- If registration is not included when purchasing the system, your credit card details will be required to activate your account.

Multimedia system:

 **Radio** ▶ **SiriusXM**  
▶ **Options**

- ▶ Select **Service Information**.  
The service information screen appears showing the radio ID and the current subscription status.
- ▶ Establish a telephone connection.
- ▶ Follow the service staff's instructions.  
The activation process may take up to ten minutes.
- ⓘ You can also have the satellite service activated online. To do so, please visit <https://www.siriusxm.com> (USA) or <https://www.siriusxm.ca> (Canada).

[www.siriusxm.com](https://www.siriusxm.com) (USA) or <https://www.siriusxm.ca> (Canada).

## Music and sport alerts

Multimedia system:

 **Radio** ▶ **SiriusXM** ▶ **Alerts**

### Setting music and sport alerts

This function enables you to program an alert for your favorite artists, tracks or sporting events. Music alerts can be saved whilst a track is being played and sport alerts can be saved during a live game. You can also specify sport alerts via the menu option. The system then continuously searches through all the channels.

- ▶ Set a music or sports alert, to be informed of matches in the Live program.

### Activating the music information function

- ▶ Activate **Music Alerts** .

### Setting a music alert

- ▶ Select **Add Alert**.

- ▶ Select **Artists** or **Song** in the dialog window. The alert is set for the current artist or track. If a match is found, a prompt appears asking whether you wish to change to the station.

#### Activating sports information

- ▶ Activate **Activate Sports Alerts** .

#### Setting a sport alert

- ▶ Select **Add Alert**.
- ▶ Select the team name or league in the dialog window.

#### Deleting individual sports and music alerts

- ▶ Select **Manage Music Alerts**.

or

- ▶ Select **Manage Sports Alerts**.
- ▶ Select an artist or track.

or

- ▶ Select a team.
- ▶ Select **Delete Selected Entries**. All highlighted alerts are deleted.

#### Deleting all sports and music alerts

- ▶ Select **Manage Music Alerts**.

or

- ▶ Select **Manage Sports Alerts**.
- ▶ Select **Delete All Entries**. All alerts are deleted.

### Sound settings

#### Overview of functions in the sound menu

The setting options and functions available depend on the sound system installed. You can find out which sound system is installed in your vehicle in the Digital Operator's Manual.

#### Standard sound system and Advanced sound system

The following functions are available:

- Equalizer:
  - Treble, mid-range and bass
- Balance and fader
- Volume:
  - Automatic adjustment

#### Burmester® surround sound system and Burmester® high-end 3D surround sound system

The following functions are available:

- Equalizer:
  - Treble, mid-range and bass
- Balance and fader
- Sound focus
- VIP seat (Burmester® high-end 3D surround sound system only)
- Sound profiles
- Volume:
  - Automatic adjustment

## ASSYST PLUS service interval display

### Function of the ASSYST PLUS service interval display

The ASSYST PLUS service interval display on the instrument display informs you of the time or distance remaining before the next service due date.

You can hide this service display using the  back button on the left-hand side of the steering wheel.

Depending on how the vehicle is used, the ASSYST PLUS service interval display may shorten the service interval, e.g. in the following cases:

- Mainly short-distance driving
- When the engine is often left idling for long periods
- In the event of frequent cold start phases

Mercedes-Benz recommends avoiding such operating conditions.



You can obtain information concerning the servicing of your vehicle from a qualified specialist workshop, e.g. an authorized Mercedes-Benz Center.

### Displaying the service due date

On-board computer:

 Service  ASSYST PLUS

The next service due date is displayed.

 **To exit the display:** press the  back button on the left-hand side of the steering wheel.

Bear in mind the following related topic:

- Operating the on-board computer (→ page 218).

### Information on regular maintenance work

 **NOTE** Premature wear through failure to observe service due dates

Maintenance work which is not carried out at the right time or incompletely can lead to increased wear and damage to the vehicle.

 Adhere to the prescribed service intervals.

 Always have the prescribed maintenance work carried out at a qualified specialist workshop.

### Notes on special service requirements

The prescribed service interval is based on normal operation of the vehicle. Have the maintenance work carried out more often than prescribed if operating conditions are difficult or the vehicle is subject to increased stress.

The ASSYST PLUS service interval display is only an aid. The driver of the vehicle bears responsibility as regards to whether maintenance work needs to be performed more often than specified based on the actual operating conditions and/or loads.

Examples of arduous operating conditions:

- Regular city driving with frequent intermediate stops
- Mainly short-distance driving
- Frequent operation in mountainous terrain or on poor road surfaces

- When the engine is often left idling for long periods
- Operation in particularly dusty conditions and/or if air-recirculation mode is frequently used

In these or similar operating conditions, have the interior air filter, air filter, engine oil and oil filter, for example, changed more frequently. The tires must be checked more frequently if the vehicle is operated under increased loads. Further information can be obtained at a qualified specialist workshop.

### Battery disconnection periods

The ASSYST PLUS service interval display can calculate the service due date only when the battery is connected.

- ▶ Display and note down the service due date on the instrument display before disconnecting the battery (→ page 267).

### Engine compartment

#### Opening and closing the hood

- ⚠ **WARNING** Risk of accident due to driving with the hood unlocked

The hood may open and block your view.

- ▶ Never release the hood when driving.
- ▶ Before every trip, ensure that the hood is locked.

- ⚠ **WARNING** Risk of accident and injury when opening and closing the hood

The hood may suddenly drop into the end position.

There is a risk of injury for anyone in the hood's range of movement.

- ▶ Do not open or close the hood if there is a person in the hood's range of movement.

- ⚠ **WARNING** Risk of burns when opening the hood

If you open the hood in the event of an overheated engine or fire in the engine compartment, the following situations may occur:

- You may come into contact with hot gases.
- You may come into contact with other escaping hot operating fluids.
- ▶ Before opening the hood, allow the engine to cool down.
- ▶ In the event of a fire in the engine compartment, keep the hood closed and call the fire service.

- ⚠ **WARNING** Risk of injury due to moving parts

Components in the engine compartment may continue to run or start unexpectedly even when the drive system is switched off.

Observe the following if you must open the hood:



- ▶ Switch off the vehicle.
- ▶ Never touch the danger zones surrounding moving components, e.g. the rotation area of the fan.
- ▶ Remove jewellery and watches.
- ▶ Keep items of clothing and hair away from moving parts.

**⚠ WARNING** Risk of injury from touching live components

The ignition system and the fuel injection system operate with a high voltage. You could receive an electric shock.

- ▶ Never touch components of the ignition system or fuel injection system when the vehicle is switched on.

The live components include the following, for example:

- Ignition coils
- Fuel injectors

- Electric lines to the ignition coils and the fuel injectors

**⚠ WARNING** Risk of burns from hot component parts in the engine compartment

Certain component parts in the engine compartment can be very hot, e.g. the engine, the cooler and parts of the exhaust system.

- ▶ Allow the engine to cool down and only touch component parts described in the following.

**⚠ WARNING** Risk of injury from using the windshield wipers when the hood is open

If the windshield wipers start moving when the hood is open, you could be trapped by the wiper linkage.

- ▶ Always switch off the windshield wipers and the vehicle first if you need to open the hood.

## Opening the hood

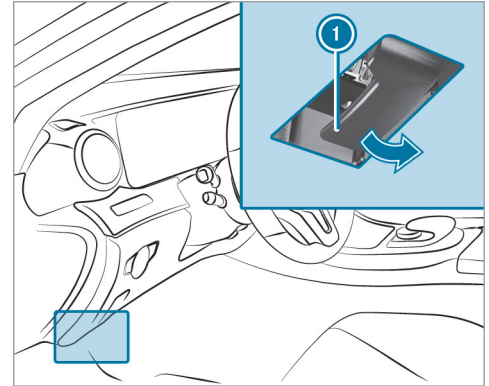

- ▶ To release the hood, pull on handle ①.

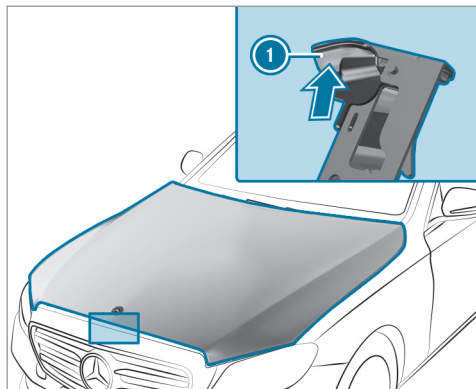

- ▶ Push handle ① of the hood catch upwards and lift the hood until it opens automatically.

### Closing the hood

- ▶ Lower the hood to a height of around 8 in (20 cm) and then allow it to fall, applying a little force as you let it go.

- ▶ If the hood can still be lifted slightly, open the hood again and close it with a little more force until it engages correctly.

### Engine oil

#### Checking the engine oil level using the on-board computer

##### Requirements:

- The engine has been warmed up.
- The vehicle is parked on a level surface.
- The engine is running at idle speed.
- The hood is closed.

The engine oil level is determined during driving. Determining the engine oil level can take up to 30 minutes with a normal driving style and even longer with an active driving style.

On-board computer:

➔ **Service** ▶ **Engine Oil Level**

One of the following messages will appear on the instrument display:

- **Measuring Engine Oil Level...**: measurement of the oil level is not yet possible.
- ▶ Repeat the request after a maximum of 30 minutes' driving.
- **Engine Oil Level OK** and the bar display for indicating the oil level on the instrument display is green and is between "min" and "max": the oil level is correct.
- **Engine Oil Level Add 1,1 qts.** and the bar display for indicating the oil level on the instrument display is orange and is below "min":
- ▶ Add 1.1 US qt (1 l) of engine oil.
- **Reduce Engine Oil Level** and the bar display for indicating the oil level on the instrument display is orange and is above "max":

- ▶ Drain off any excess engine oil that has been added. To do so, consult a qualified specialist workshop.
- **For Engine Oil Level Switch Ignition On**
- ▶ Switch on the vehicle to check the engine oil level.
- **Engine Oil Level System Inoperative:** The oil level sensor is defective or not connected.
- ▶ Consult a qualified specialist workshop.
- **Engine Oil Level System Currently Unavail.**
- ▶ Close the hood.

### Refilling engine oil

**⚠ WARNING** Risk of burns from hot component parts in the engine compartment

Certain component parts in the engine compartment can be very hot, e.g. the engine, the cooler and parts of the exhaust system.

- ▶ Allow the engine to cool down and only touch component parts described in the following.

**⚠ WARNING** Risk of fire and injury from engine oil

If engine oil comes into contact with hot component parts in the engine compartment, it may ignite.

- ▶ Make sure that no engine oil is spilled next to the filler opening.
- ▶ Allow the engine to cool off and thoroughly clean the engine oil from component parts before starting the vehicle.

**⚠ NOTE** Engine damage caused by an incorrect oil filter, incorrect oil or additives

- ▶ Do not use engine oils or oil filters which do not correspond to the specifications explicitly prescribed for the service intervals.
- ▶ Follow the instructions on the service interval display for changing the engine oil and observe the prescribed change intervals.
- ▶ Do not use additives.

**⚠ NOTE** Damage caused by refilling too much engine oil

Too much engine oil can damage the engine or the catalytic converter.

- ▶ Have excess engine oil removed at a qualified specialist workshop.

- ⓘ Depending on driving style, the vehicle consumes up to 0.9 US qt (0.8 liter) of oil per 600 miles (1000 km). The oil consumption may be higher than this when the vehicle is new or if you frequently drive at high engine speeds.

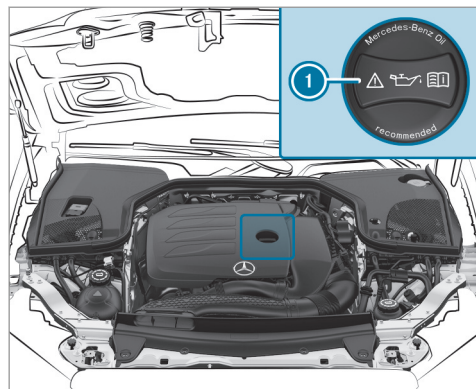

- ▶ Turn cap ① counter-clockwise and remove it.
- ▶ Add engine oil.
- ▶ Replace cap ① and turn it clockwise until it engages.
- ▶ Check the oil level again (→ page 270).

### Checking the coolant level

**⚠ WARNING** Risk of burns from hot component parts in the engine compartment

Certain component parts in the engine compartment can be very hot, e.g. the engine, the cooler and parts of the exhaust system.

- ▶ Allow the engine to cool down and only touch component parts described in the following.

**⚠ WARNING** Risk of scalding from hot coolant

If you open the cap, you could be scalded.

- ▶ Let the motor cool down before opening the cap.
- ▶ When opening the cap, wear protective gloves and safety glasses.
- ▶ Open the cap slowly to release pressure.

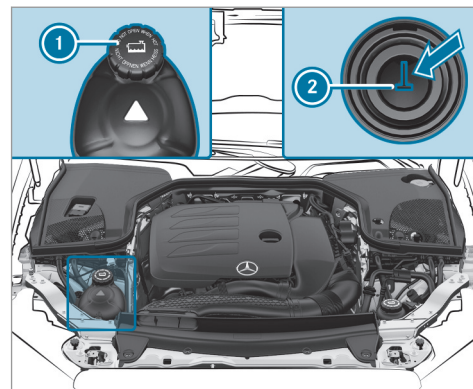

- ▶ Park the vehicle on a level surface.
- ▶ Check the coolant temperature display in the instrument cluster. The coolant temperature must be in the bottom quarter of the temperature display.
- ▶ Slowly turn cap ① counter-clockwise to release overpressure.

- ▶ Continue turning cap ① counter-clockwise and remove it.

The coolant level is correct in the following cases:

- If the engine is cold, the coolant is up to marker bar ②.
  - If the engine is warm, the coolant is up to 0.6 in (1.5 cm) over the marker bar ②.
- ▶ If necessary, add coolant that has been approved for Mercedes-Benz.

① Further information on coolant (→ page 340)

### Refilling the windshield washer system

**⚠ WARNING** Risk of burns from hot component parts in the engine compartment

Certain component parts in the engine compartment can be very hot, e.g. the engine, the cooler and parts of the exhaust system.

- ▶ Allow the engine to cool down and only touch component parts described in the following.

**⚠ WARNING** - Risk of fire and injury from windshield washer concentrate

Windshield washer concentrate is highly flammable. It could ignite if it comes into contact with hot engine component parts or the exhaust system.

- ▶ Make sure that no windshield washer concentrate spills out next to the filler opening.

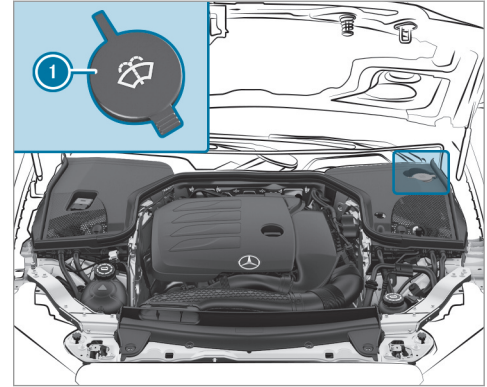

- ▶ Remove cap ① by the tab.
  - ▶ Add washer fluid.
- ① Further information about the windshield washer fluid (→ page 341)

### Keeping the air-water duct free

- ▶ Keep the area between the hood and the windshield free of deposits, e.g. ice, snow and leaves.

### Cleaning and care

#### Notes on washing the vehicle in a car wash

**⚠ WARNING** Risk of accident due to reduced braking effect after washing the vehicle

The braking effect is reduced after washing the vehicle.

- ▶ After the vehicle has been washed, brake carefully while paying attention to the traffic conditions until the braking effect has been fully restored.

#### **!** NOTE Damage from automatic braking

If one of the following functions is switched on, the vehicle brakes automatically in certain situations:

- Active Brake Assist
- Active Distance Assist DISTRONIC
- HOLD function
- Active Parking Assist

To avoid damage to the vehicle, deactivate these systems in the following or similar situations:

- ▶ During towing
- ▶ In a car wash

#### **!** NOTE Damage due to unsuitable car wash

- ▶ Before driving into a car wash make sure that the car wash is suitable for the vehicle dimensions.

- ▶ Ensure there is sufficient ground clearance between the underbody and the guide rails of the car wash.
- ▶ Ensure that the clearance width of the car wash, in particular the width of the guide rails, is sufficient.

To avoid damage to your vehicle when using a car wash, ensure the following beforehand:

- Active Distance Assist DISTRONIC is deactivated.
- The HOLD function is switched off.
- The surround view camera or the rear view camera is switched off.
- The side windows and sliding sunroof are completely closed.
- The blower for the ventilation and heating is switched off.
- The windshield wiper switch is in position **0**.
- The SmartKey is at a minimum distance of 10 ft (3 m) away from the vehicle. Otherwise, the trunk lid could open unintentionally.
- For car washes with a conveyor system:

- Neutral **N** is engaged.
- If you would like to leave the vehicle while it is being washed, make sure the SmartKey is located in the vehicle. The park position **P** is otherwise automatically engaged.

**i** If, after the car wash, you remove the wax from the windshield and wiper rubbers, this will prevent smearing and reduce wiper noise.

### Notes on using a power washer

**⚠ WARNING** Risk of an accident when using power washers with round-spray nozzles

The water jet can cause externally invisible damage.

Components damaged in this way may unexpectedly fail.

- ▶ Do not use a power washer with round-spray nozzles.
- ▶ Have damaged tires or chassis parts replaced immediately.

To avoid damage to your vehicle, observe the following when using a power washer:

- The SmartKey is at a minimum distance of 10 ft (3 m) away from the vehicle. Otherwise, the trunk lid could open unintentionally.
- Maintain a distance of at least 11.8 in (30 cm) to the vehicle.
- **Vehicles with decorative foil:** Parts of your vehicle are covered with a decorative foil. Maintain a distance of at least 27.6 in (70 cm) between the foil-covered parts of the vehicle and the nozzle of the power washer. Move the power washer nozzle around whilst cleaning. The water temperature of the power washer must not exceed 140°F (60°C).
- Observe the information on the correct distance in the equipment manufacturer's operating instructions.
- Do not direct the nozzle of the power washer directly at sensitive parts, such as tires, gaps, electrical components, batteries, light sources and ventilation slits.

### Washing the vehicle by hand

**!** **NOTE** Engine damage due to water ingress

- ▶ Take care not to point the water jet directly towards the air inlet grille below the hood.

Observe the legal requirements, e.g. in a number of countries, washing by hand is only permitted in specially designated wash bays.

- ▶ Use a mild cleaning agent, e.g. car shampoo.
- ▶ Wash the vehicle with lukewarm water using a soft car sponge. When doing so, do not expose the vehicle to direct sunlight.
- ▶ Carefully hose the vehicle off with water and dry using a chamois.

**i** Observe the notes on the care of vehicle parts (→ page 277).

### Notes on paintwork/matte finish paintwork care

To avoid damaging the paintwork and interfering with the driving assistance systems, please observe the following notes:

### Paint

- Insect remains: soak with insect remover and rinse off the treated areas afterwards.
- Bird droppings: soak with water and rinse off afterwards.
- Tree resin, oils, fuels and greases: remove by rubbing gently with a cloth soaked in petroleum ether or lighter fluid.
- Coolant and brake fluid: remove with a damp cloth and clean water.
- Tar stains: use tar remover.
- Wax: use silicone remover.
- Do not attach stickers, films or similar materials. Only have film attached to the bumper at a qualified specialist workshop.
- Remove dirt immediately, where possible.

### Matte finish

- Only use care products approved for Mercedes-Benz.
- Do not attach stickers, films or similar materials. Only have film attached to the bumper at a qualified specialist workshop.

- Do not polish the vehicle and alloy wheels.
- Only use car washes that correspond to the latest engineering standards.
- Do not use car wash program with a final hot wax treatment.
- Do not use paint cleaners, buffing or polishing products, gloss preservers, e.g. wax.

In the event of paintwork damage:

- Always have paintwork repairs carried out at a qualified specialist workshop.
- Make sure the radar sensors function (→ page 163).

### Notes on cleaning decorative foils

Observe the notes on matte finish care in the chapter "Notes on paintwork/matte finish paintwork care" (→ page 275). They also apply to matte decorative foils.

Observe the notes on cleaning decorative foils to avoid vehicle damage.

### Cleaning

- For cleaning, use plenty of water and a mild cleaning agent without additives or abrasive substances, e.g. a car shampoo approved for Mercedes-Benz.
- Remove dirt immediately, where possible, whilst avoiding rubbing too hard. There is otherwise a risk of damaging the decorative foil irreparably.
- If there is dirt on the finish or if the decorative foil is dull: use the Paint Cleaner recommended and approved for Mercedes-Benz.
- Insect remains: soak with insect remover and rinse off the treated areas afterwards.
- Bird droppings: soak with water and rinse off afterwards.
- To prevent water stains, dry a foil-wrapped vehicle with a soft, absorbent cloth after every car wash.

### Avoiding damage to the decorative foil

- The service life and color of decorative foils are impaired by:
  - Sunlight



- Temperature, e.g. hot air blower
- Weather conditions
- Stone chippings and dirt
- Chemical cleaning agents
- Oily products
- Do not use polish on matte decorative foil. Polishing will have the effect of shining the foil-wrapped surface.
- Do not treat matte or structured decorative foils with wax. Permanent stains may occur.

Scratches, corrosive deposits, areas affected by corrosion and damage caused by incorrect care cannot always be completely repaired. In such cases, visit a qualified specialist workshop.

You can obtain more information on care and cleaning products from the manufacturer.

In the case of foil-wrapped surfaces, optical differences may occur between the surfaces that were not protected by a decorative foil after removing a decorative foil.

- ⓘ Have work or repairs to decorative foils carried out at a qualified specialist workshop, e.g. at an authorized Mercedes-Benz Center.

### Notes on care of vehicle parts

**⚠ WARNING** Risk of entrapment if the windshield wipers are switched on while the windshield is being cleaned

If the windshield wipers are set in motion while you are cleaning the windshield or wiper blades, you can be trapped by the wiper arm.

- ▶ Always switch off the windshield wipers and the vehicle before cleaning the windshield or wiper blades.

**⚠ WARNING** Risk of burns from the tailpipe and tailpipe trims

The exhaust tailpipe and tailpipe trims can become very hot. If you come into contact with these parts of the vehicle, you could burn yourself.

- ▶ Always be particularly careful around the tailpipe and the tailpipe trims and supervise children especially closely in this area.
- ▶ Allow vehicle parts to cool down before touching them.

To avoid damage to the vehicle, observe the notes on cleaning and care of the following vehicle parts:

#### Wheels and rims

- Use water and acid-free alloy wheel cleaners.
- Do not use acidic alloy wheel cleaners to remove brake dust. This could damage wheel bolts and brake components.
- To avoid corrosion of the brake discs and brakepads, drive the vehicle for a few minutes after cleaning before parking it. The brake discs and brakepads warm up and dry out.

#### Windows

- Clean the windows inside and outside with a damp cloth and with a cleaning agent recommended for Mercedes-Benz.

- Do not use dry cloths or abrasive or solvent-based cleaning agents to clean the inside of windows.
- ① After changing the wiper blades or treating the vehicle with wax, clean the windshield thoroughly with cleaning agents recommended for Mercedes-Benz. Failure to observe the application instructions may result in damage, smear marks or blinding spots.
- ① Remove external fogging or dirt on the windshield in front of the multifunction camera. Otherwise, driving systems and driving safety systems may be impaired or not available (→ page 163).

#### Wiper blades

- Move the wiper arms into the replacement position (→ page 121).
- With the wiper arms folded out, clean the wiper blades with a damp cloth.
- ① Make sure that the wiper blades are coated. The coating can leave residues on a cloth. Do not rub the wiper blades excessively or clean them too often.

#### Exterior lighting

- Clean the lenses with a wet sponge and mild cleaning agent, e.g. car shampoo.
- Only use cleaning agents or cleaning cloths that are suitable for plastic lenses.

#### Sensors

- Clean the sensors in the front and rear bumpers with a soft cloth and car shampoo (→ page 163).
- When using a power washer, maintain a minimum distance of 11.8 in (30 cm).

#### Rear view camera and surround view camera

- Open the camera cover with the multimedia system (→ page 204).
- Use clean water and a soft cloth to clean the camera lens.
- Do not use a power washer.

#### Tailpipes

- Clean with a cleaning agent recommended for Mercedes-Benz, especially in the winter and after washing the vehicle.
- Do not use acidic cleaning agents.

#### Notes on care of the interior

**⚠ WARNING** Risk of injury from plastic parts breaking off after the use of solvent-based care products

Care and cleaning products containing solvents can cause surfaces in the cockpit to become porous. When the airbags are deployed, plastic parts may break away.

- ▶ Do not use any care or cleaning products containing solvents to clean the cockpit.

**⚠ WARNING** Risk of injury or fatal injuries from bleached seat belts

Bleaching or dyeing seat belts can severely weaken them.

This can, for example, cause seat belts to tear or fail in an accident.

- ▶ Never bleach or dye seat belts.

To avoid damage to the vehicle, observe the following notes on cleaning and care:

**Seat belts**

- Clean with lukewarm and soapy water.
- Do not use chemical cleaning agents.
- Do not dry by heating them to over 176°F (80°C) or exposing them to direct sunlight.

**Display**

- Switch off the display and let it cool down.
- Clean the surface carefully with a microfiber cloth and a suitable display care product (TFT-LCD).
- Do not use any other agents.

**Head-up Display**

- Clean with a soft, non-static, lint-free cloth.
- Do not use cleaning agents.

**Plastic trim**

- Clean with a damp microfiber cloth.
- For heavy soiling: Use a cleaner recommended for Mercedes-Benz.
- Do not attach stickers, films or similar materials.

- Do not allow cosmetics, insect repellent or sun cream to come in contact with the plastic trim.

**Real wood and trim elements**

- Clean with a microfiber cloth.
- Black piano-lacquer look: Clean with a damp cloth and soapy water.
- For heavy soiling: Use a cleaner recommended for Mercedes-Benz.
- Do not use solvent-based cleaning agents, polishes or waxes.

**Headliner**

- Clean with a brush or dry shampoo.

**Carpet**

- Use a carpet and textile cleaning agent recommended for Mercedes-Benz.

**Steering wheel made of genuine leather or DINAMICA**

**!** NOTE Damage caused by wrong cleaners

- ▶ Do not use solvent-based cleaning agents such as tar remover or wheel

cleaner; neither should you use polishes or waxes. Otherwise you may damage the finish.

- Clean with a damp cloth and 1% soapy water solution and then wipe with a dry cloth.
- For heavy soiling: Use a cleaner recommended for Mercedes-Benz.
- Leather care: Use a leather care agent that has been recommended for Mercedes-Benz.
- Do not allow the leather to become too damp.
- Do not use a microfiber cloth.
- ⓘ Leather is a natural product. It has natural surface properties, such as differences in structure, marks caused by growth and injury or subtle color differences. These surface properties are characteristics of leather and not material faults. What's more, leather is subject to a natural aging process during which the surface properties change.

**Genuine leather seat covers**

- Clean with a damp cloth and then wipe with a dry cloth.

- Leather care: Use a leather care agent that has been recommended for Mercedes-Benz.
  - Do not allow the leather to become too damp.
  - Do not use a microfiber cloth.
- ⓘ Regular cleaning and care of the leather reduces soiling, wear marks and aging damage and thus significantly extends its life span. Clothing that can leave stains, e.g. jeans, can leave discoloration on the leather.

**DINAMICA seat covers**

- Clean with a damp cloth.
- Do not use a microfiber cloth.

**Imitation leather seat covers**

- Clean with a damp cloth and 1% soapy water.
- Do not use a microfiber cloth.

**Fabric seat covers**

- Clean with a damp microfiber cloth and 1% soapy water and allow to dry.

## Emergency

### Removing the safety vest

The safety vests are located in the storage compartments in the driver's and front passenger door.

- ▶ Pull out the safety vest bag by the loop.
- ▶ Open the safety vest bag and pull out the safety vest.

**i** There are also safety vest compartments in the rear door storage compartments in which safety vests can be stored.

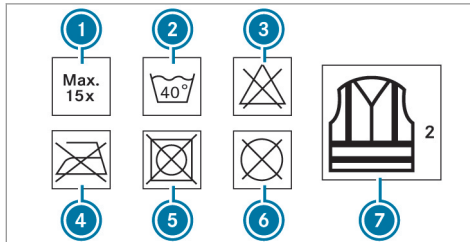

- ① Maximum number of washes
- ② Maximum wash temperature

- ③ Do not bleach
- ④ Do not iron
- ⑤ Do not tumble dry
- ⑥ Do not dry clean
- ⑦ Class 2 safety vest

The requirements defined by the legal standard are only fulfilled if the safety vest is the correct size and is fully closed.

Replace the safety vest in the following cases:

- The reflective strips are damaged or dirty
- The maximum permissible number of washes is exceeded
- The fluorescence has faded

### Warning triangle

#### Removing the warning triangle

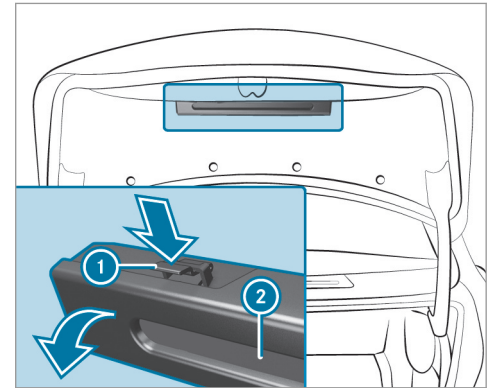

- ▶ Push both sides of warning triangle holder **①** in the direction of the arrow and open it.
- ▶ Remove warning triangle **②**.

### Setting up the warning triangle

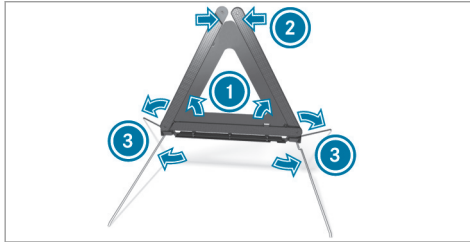

- ▶ Fold side reflectors ① upwards to form a triangle and attach at the top using upper press-stud ②.
- ▶ Fold legs ③ down and out to the side.

### First-aid kit (soft-sided) overview

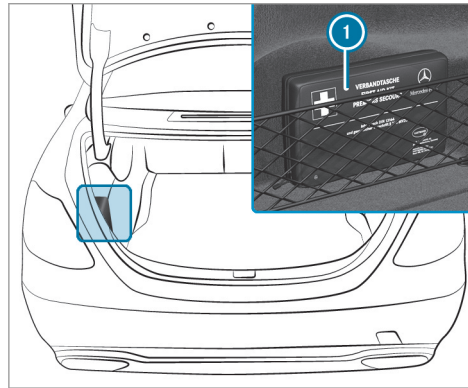

First-aid kit (soft sided) ① is on the left or right in the trunk, depending on the vehicle version.

- ① In vehicles with a Burmester® surround sound system, the first-aid kit (soft sided) is located in the trunk when the vehicle is delivered.

### Flat tire

#### Notes on flat tires

**⚠ WARNING** Risk of accident due to a flat tire

A flat tire severely affects the driving characteristics as well as the steering and braking of the vehicle.

#### Tires without run-flat characteristics:

- ▶ Do not drive with a flat tire.
- ▶ Change the flat tire immediately with an emergency spare wheel or spare wheel. Alternatively, consult a qualified specialist workshop.

#### Tires with run-flat characteristics:

- ▶ Observe the information and warning notes on MOExtended tires (run-flat tires).

In the event of a flat tire, the following options are available depending on your vehicle's equipment:

- **Vehicles with MOExtended tires:** it is possible to continue the journey for a short period of time. Make sure you observe the notes on MOExtended tires (run-flat tires) (→ page 283).
  - **Vehicles with a TIREFIT kit:** you can repair the tire so that it is possible to continue the journey for a short period of time. To do this, use the TIREFIT kit (→ page 284).
  - **Vehicles with Mercedes me connect:** you can make a call for breakdown assistance via the overhead control panel in the case of a breakdown (→ page 249).
  - **All vehicles:** change the wheel (→ page 324).
- i** The emergency spare wheel is only available in certain countries.

### Notes on MOExtended tires (run-flat tires)

**▲ WARNING** Risk of accident when driving in limp-home mode

When driving in emergency mode the handling characteristics are impaired.

- ▶ Do not exceed the specified maximum speed of the MOExtended tires.
- ▶ Avoid any abrupt steering and driving maneuvers as well as driving over obstacles (curbs, pot holes, off-road). This applies, in particular, to a loaded vehicle.
- ▶ Stop driving in the emergency mode if you notice:
  - Banging noise
  - Vehicle vibration
  - Smoke which smells like rubber
  - Continuous ESP® intervention
  - Cracks in the tire side walls
- ▶ After driving in emergency mode, have the rims checked by a qualified specialist

workshop with regard to their further use.

- ▶ The defective tire must be replaced in every case.

With MOExtended tires (run-flat tires), you can continue to drive your vehicle even if there is a total loss of pressure in one or more tires. However, the tire affected must not show any clearly visible damage.

You can recognize MOExtended tires by the MOExtended marking which appears on the side wall of the tire.

**Vehicles with tire pressure loss warning system:** MOExtended tires may only be used in conjunction with an activated tire pressure loss warning system.

**Vehicles with tire pressure monitoring system:** MOExtended tires may only be used in conjunction with an activated tire pressure monitoring system.

If a pressure loss warning message appears in the driver's display, proceed as follows:

- Check the tire for damage.

- If driving on, observe the following notes.

#### Driving distance possible in emergency mode after the pressure loss warning:

Load condition	Driving distance possible in emergency mode
Partially laden	50 miles (80 km)
Fully laden	19 miles (30 km)

The driving distance possible in emergency mode may vary depending on the driving style. Observe the maximum permissible speed of 50 mph (80 km/h).

If a tire has gone flat and cannot be replaced with an MOExtended tire, you can use a standard tire as a temporary measure.

#### TIREFIT kit storage location

The TIREFIT kit is located under the trunk floor.

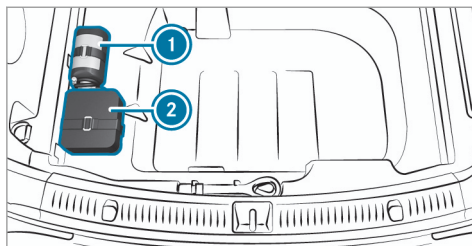

- ① Tire sealant bottle
- ② Tire inflation compressor

Depending on the model, the TIREFIT kit may also be located in other places under the trunk floor.

#### Using the TIREFIT kit

##### Requirements:

- Tire sealant bottle and tire inflation compressor (→ page 284)
- TIREFIT sticker
- Gloves

You can use TIREFIT tire sealant to seal perforation damage of up to 0.16 in (4 mm), particularly those in the tire contact surface. You can use TIREFIT in outside temperatures down to -4 °F (-20 °C).

#### **⚠ WARNING** Risk of accident when using tire sealant

The tire sealant may be unable to seal the tire properly, especially in the following cases:

- There are large cuts or punctures in the tire (larger than damage previously mentioned)
- The wheel rims have been damaged
- After journeys with very low tire pressure or with flat tires

- ▶ Do not continue driving.
- ▶ Consult a qualified specialist workshop.



**⚠ WARNING** Risk of injury and poisoning from tire sealant

The tire sealant is harmful and causes irritation. Do not allow it to come into contact with the skin, eyes or clothing, and do not swallow it. Do not inhale tire sealant fumes. Keep the tire sealant away from children.

If you come into contact with the tire sealant, observe the following:

- ▶ Rinse off the tire sealant from your skin immediately using water.
- ▶ If tire sealant gets into your eyes, thoroughly rinse out the eyes using clean water.
- ▶ If tire sealant has been swallowed, immediately rinse out the mouth thoroughly and drink plenty of water. Do not induce vomiting and seek medical attention immediately.
- ▶ Change out of any clothes contaminated with tire sealant immediately.
- ▶ If allergic reactions occur, seek medical attention immediately.

**! NOTE** Overheating due to the tire inflation compressor running too long

- ▶ Do not run the tire inflation compressor for longer than ten minutes without interruption.

Comply with the manufacturer's safety notes on the sticker on the tire inflation compressor.

Have the tire sealant bottle replaced in a qualified specialist workshop every five years.

- ▶ Do not remove any foreign objects which have entered the tire.

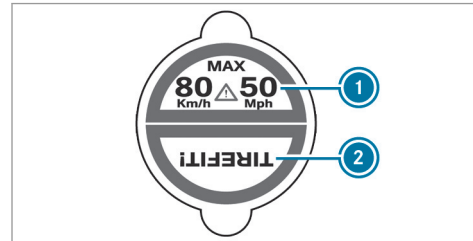

- ▶ Affix part ① of the TIREFIT sticker to the instrument cluster within the driver's field of vision.
- ▶ Affix part ② of the TIREFIT sticker near the valve on the wheel with the faulty tire.

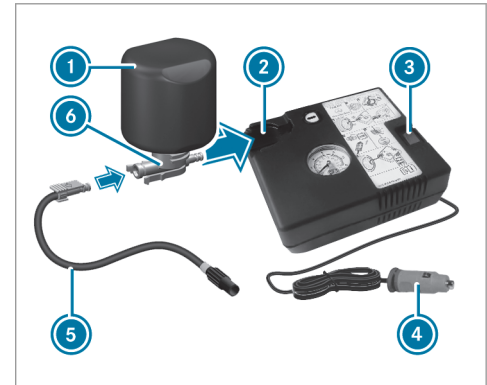

- ▶ Pull plug ④ with the cable and hose ⑤ out of the tire inflation compressor housing.

- ▶ Push the plug of hose ⑤ into flange ⑥ of tire sealant bottle ① until the plug engages.
- ▶ Place tire sealant bottle ① head downwards into recess ② of the tire inflation compressor.

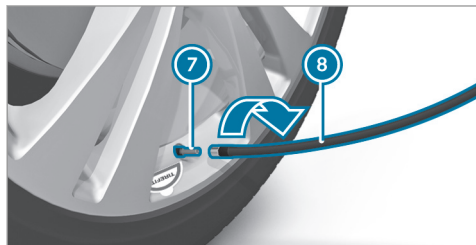

- ▶ Remove the valve cap from valve ⑦ on the faulty tire.
- ▶ Screw filling hose ⑥ onto valve ⑦.
- ▶ Insert plug ④ into a 12 V socket in your vehicle.
- ▶ Switch on the vehicle.

- ▶ Switch on the tire inflation compressor using On/Off switch ③.  
The tire is inflated. First, tire sealant is pumped into the tire. The pressure may briefly rise to approximately 500 kPa (5.0 bar/73 psi).

#### Do not switch off the tire inflation compressor during this phase!

- ▶ Let the tire inflation compressor run for a maximum of ten minutes.  
The tire should then have attained a tire pressure of at least 200 kPa (2.0 bar/29 psi).

If tire sealant leaks out, make sure you clean the affected area as quickly as possible. It is preferable to use clean water.

If you get tire sealant on your clothing, have it cleaned as soon as possible with perchloroethylene.

#### If, after ten minutes, a tire pressure of 200 kPa (2.0 bar/29 psi) has not been attained:

- ▶ Switch off the tire inflation compressor.
- ▶ Unscrew the filling hose from the valve of the faulty tire.

Please note that tire sealant may leak out when unscrewing the filling hose.

- ▶ Drive forwards or in reverse very slowly for approximately 33 ft (10 m).
- ▶ Pump up the tire again.  
After a maximum of ten minutes the tire pressure must be at least 200 kPa (2.0 bar/29 psi).

**⚠ WARNING** Risk of accident due to the specified tire pressure not being achieved

If the specified tire pressure is not achieved after the specified time, the tire is too badly damaged. The tire sealant cannot repair the tire in this instance.

The braking characteristics as well as the driving characteristics may be greatly impaired.

- ▶ Do not continue driving.
- ▶ Consult a qualified specialist workshop.

#### If, after ten minutes, a tire pressure of 200 kPa (2.0 bar/29 psi) has been attained:

- ▶ Switch off the tire inflation compressor.

- ▶ Unscrew the filling hose from the valve of the faulty tire.

**⚠ WARNING** Risk of accident from driving with sealed tires

A tire temporarily sealed with tire sealant impairs the handling characteristics and is not suitable for higher speeds.

- ▶ Adapt your driving style accordingly and drive carefully.
- ▶ Do not exceed the maximum speed limit with a tire that has been repaired using tire sealant.

- ▶ Observe the maximum permissible speed for a tire sealed with tire sealant 50 mph (80 km/h).

**! NOTE** Staining caused by leaking tire sealant

After use, excess tire sealant may leak out from the filling hose.

- ▶ Therefore, place the filling hose in the plastic bag that contained the TIREFIT kit.

**🌿 ENVIRONMENTAL NOTE** Environmental pollution caused by environmentally irresponsible disposal

Tire sealant contains pollutants.

- ▶ Have the tire sealant bottle disposed of professionally, e.g. at an authorized Mercedes-Benz Center.

- ▶ Stow the tire sealant bottle and the tire inflation compressor.
- ▶ Pull away immediately.
- ▶ Stop driving after approximately ten minutes and check the tire pressure using the tire inflation compressor. The tire pressure must now be at least 130 kPa (1.3 bar/19 psi).

**⚠ WARNING** Risk of accident due to the specified tire pressure not being attained

If the specified tire pressure is not reached, the tire is too badly damaged. The tire sealant cannot repair the tire in this instance.

The braking and driving characteristics may be greatly impaired.

- ▶ Do not continue driving.
- ▶ Consult a qualified specialist workshop.

In cases such as the one mentioned above, contact an authorized Mercedes-Benz Center. Or call 1-800-FOR-MERCEDES (in the USA) or 1-800-387-0100 (in Canada).

- ▶ Correct the tire pressure if it is still at least 130 kPa (1.3 bar/19 psi). See the Tire and Loading Information placard on the B-pillar on the driver's side or the tire pressure table in the fuel filler flap for values.
- ▶ **To increase the tire pressure:** switch on the tire inflation compressor.

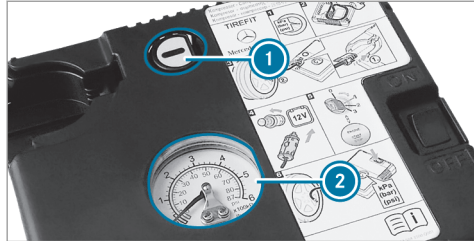

- ▶ **To reduce the tire pressure:** press pressure release button ① next to manometer ②.
- ▶ When the tire pressure is correct, unscrew the filling hose from the valve of the sealed tire.
- ▶ Screw the valve cap onto the valve of the sealed tire.
- ▶ Pull the tire sealant bottle out of the tire inflation compressor. The filling hose stays on the tire sealant bottle.
- ▶ Drive to the nearest qualified specialist workshop and have the tire, tire sealant bottle and filling hose replaced there.

## Battery (vehicle)

### Notes on the 12 V battery

**⚠ WARNING** Risk of an accident due to work carried out incorrectly on the battery

Work carried out incorrectly on the battery can, for example, lead to a short circuit. This can restrict functions relevant for safety systems and impair the operating safety of your vehicle.

You could lose control of the vehicle in the following situations in particular:

- When braking
- In the event of abrupt steering maneuvers and/or when the vehicle's speed is not adapted to the road conditions
- ▶ In the event of a short circuit or a similar incident, contact a qualified specialist workshop immediately.
- ▶ Do not drive on.
- ▶ Always have work on the battery carried out at a qualified specialist workshop.

- Further information on ABS (→ page 164)
- Further information on ESP® (→ page 165)

For safety reasons, Mercedes-Benz recommends that you only use batteries which have been tested and approved for your vehicle by Mercedes-Benz.

### All vehicles except vehicles with a lithium-ion battery

**⚠ WARNING** Risk of explosion due to electrostatic charge

Electrostatic charge can ignite the highly explosive gas mixture in the battery.

- ▶ To discharge any electrostatic charge that may have built up, touch the metal vehicle body before handling the battery.

The highly flammable gas mixture is created while the battery is charging and during starting assistance.

**⚠ WARNING** Danger of chemical burns from the battery acid

Battery acid is caustic.

- ▶ Avoid contact with the skin, eyes or clothing.
- ▶ Do not lean over the battery.
- ▶ Do not inhale battery gases.
- ▶ Keep children away from the battery.
- ▶ Immediately rinse battery acid off thoroughly with plenty of clean water and seek medical attention immediately.

#### All vehicles

**🔥 ENVIRONMENTAL NOTE** Environmental damage due to improper disposal of batteries



Batteries contain pollutants. It is illegal to dispose of them with the household rubbish.



Dispose of batteries in an environmentally responsible manner. Take discharged batteries to a qualified specialist workshop or to a collection point for used batteries.

If you have to disconnect the 12 V battery, contact a qualified specialist workshop.

Comply with safety notes and take protective measures when handling batteries.



Risk of explosion.



Fire, open flames and smoking are prohibited when handling the battery. Avoid creating sparks.



Electrolyte or battery acid is corrosive. Avoid contact with the skin, eyes or clothing. Wear suitable protective clothing, in particular gloves, an apron

and a face mask. Immediately rinse electrolyte or acid splashes off with clean water. Consult a doctor if necessary.



Wear safety glasses.



Keep children away.



Observe this Operator's Manual.

Observe the following if you do not intend to use the vehicle over an extended period of time:

- Activate standby mode.
- Alternatively: connect the battery to a battery charger approved by Mercedes-Benz or consult a qualified specialist workshop to disconnect the battery.

## Notes on starting assistance and charging the 12 V battery

### All vehicles

When charging the battery and during starting assistance, always use the jump-start connection point in the engine compartment.

**!** **NOTE** Damage to the battery from over-voltage

When charging using a battery charger without a maximum charging voltage, the battery or the on-board electronics may be damaged.

- ▶ Only use battery chargers with a maximum charging voltage of 14.8 V.

**!** **WARNING** Risk of explosion due to igniting hydrogen gas

If there is a short circuit or sparks start to form when charging a battery, there is a danger of the hydrogen gas igniting.

- ▶ Take care that the positive terminal of a connected battery does not come into contact with vehicle parts.
- ▶ Never place metal objects or tools on a battery.
- ▶ When connecting and disconnecting the battery, always observe the sequence of battery terminals described.
- ▶ Always take care to connect only battery terminals of identical polarity when jump starting a vehicle.
- ▶ During starting assistance, it is essential to observe the sequence described for connecting and disconnecting the jumper cables.
- ▶ Do not connect or disconnect the battery terminals while the engine is running.

**!** **WARNING** Risk of explosion due to a mixture of explosive gases

A mixture of explosive gases can escape from the battery during charging and jump starting.

- ▶ Fire, open flames, smoking and creating sparks must be avoided.
- ▶ Make sure that there is sufficient ventilation.
- ▶ Do not stand over the battery.

**!** **WARNING** Risk of explosion from a frozen battery

A discharged battery may freeze at temperatures slightly above or below freezing point.

During starting assistance or battery charging, battery gas can be released.

- ▶ Always allow a battery to thaw before charging it or performing starting assistance.

If the indicator/warning lamps in the instrument cluster do not light up at low temperatures, it is very likely that the discharged battery has frozen. In this case you may neither jump-start the vehicle nor charge the battery.

The service life of a battery that has been thawed may be dramatically shortened. The starting char-

acteristics may be impaired, especially at low temperatures.

It is recommended that you have a thawed battery checked at a qualified specialist workshop.

### All vehicles

**!** **NOTE** Damage caused by numerous or extended attempts to start the engine

Numerous or extended attempts to start the engine may damage the catalytic converter due to non-combusted fuel.

▶ Avoid numerous and extended attempts to start the engine.

Observe the following points during starting assistance and when charging the battery:

- Only use undamaged jumper cables/charging cables with a sufficient cross-section and insulated terminal clamps.
- Non-insulated parts of the terminal clamps must not come into contact with other metal parts while the jumper cable/charging cable

is connected to the battery/jump-start connection point.

- The jumper cable/charging cable must not come into contact with any parts which may move when the engine is running.
- Always make sure that neither you nor the battery is electrostatically charged.
- Keep away from fire and open flames.
- Do not lean over the battery.

Observe the additional following points when charging the battery:

- Only use battery chargers tested and approved for Mercedes-Benz.
- Read the battery charger's operating instructions before charging the battery.

Observe the additional following points during starting assistance:

- Starting assistance may only be provided using vehicles, batteries or other jump start devices with a nominal voltage of 12 V.
- The vehicles must not touch.

- **Vehicles with a gasoline engine:** Jump-start the vehicle only when the engine and exhaust system are cold.

### Starting assistance and charging the 12 V battery

#### Requirements:

- The vehicle is secured with the electric parking brake.
- **Vehicles with automatic transmission:** The transmission is in position **P**.
- The vehicle and all electrical consumers are switched off.
- The hood is open.

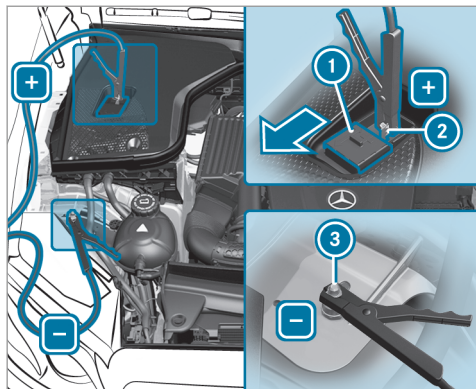

Example: engine compartment

- ▶ Slide cover ① of positive contact ② on the jump-starting connection point in the direction of the arrow.
- ▶ Connect positive contact ② on your vehicle to the positive terminal of the donor battery using the jumper cable/charging cable.

Always begin with positive contact ② on your own vehicle first.

- ▶ **During starting assistance:** start the engine of the donor vehicle and run at idle speed.
- ▶ Connect the negative terminal of the donor battery and ground point ③ of your own vehicle by using the jumper cable/charging cable. Begin with the donor battery first.
- ▶ **During starting assistance:** start the engine of your own vehicle.
- ▶ **During the charging process:** start the charging process.
- ▶ **During starting assistance:** let the engines run for several minutes.
- ▶ **During starting assistance:** before disconnecting the jumper cable, switch on an electrical consumer on your own vehicle, e.g. the rear window heater or lighting.

When the starting assistance/charging process is complete, perform the following steps:

- ▶ First, remove the jumper cable/charging cable from ground point ③ and the negative termi-

nal of the donor battery, then from positive contact ② and the positive terminal of the donor battery. Begin each time with the contacts on your own vehicle first.

- ▶ After removing the jumper cable/charging cable, close cover ① of positive contact ②.

Further information can be obtained at a qualified specialist workshop.

### Replacing the 12 V battery

- ▶ Observe the notes on the 12 V battery (→ page 288).

Mercedes-Benz recommends that you have the 12 V battery replaced at a qualified specialist workshop, e.g. at an authorized Mercedes-Benz Center.

Observe the following notes if you want to replace the battery yourself:

- Always replace a faulty battery with a battery which meets the specific vehicle requirements.



The vehicle is equipped with an AGM technology battery (Absorbent Glass Mat) or a lithium-ion battery. Full vehicle functionality is only guaranteed with an AGM battery or lithium-ion battery. For safety reasons, Mercedes-Benz recommends that you only use batteries which have been tested and approved for your vehicle by Mercedes-Benz.

- Carry over detachable parts, such as vent hoses, elbow fittings or terminal covers from the battery being replaced.
- Make sure that the vent hose is always connected to the original opening on the side of the battery.

Install any existing or supplied cell caps. Otherwise, gases or battery acid could escape.

- Make sure that detachable parts are reconnected in the same way.

### Tow starting or towing away

#### Permitted towing methods (non plug-in hybrid)

##### ! NOTE Damage from automatic braking

If one of the following functions is switched on, the vehicle brakes automatically in certain situations:

- Active Brake Assist
- Active Distance Assist DISTRONIC
- HOLD function
- Active Parking Assist

To avoid damage to the vehicle, deactivate these systems in the following or similar situations:

- ▶ During towing
- ▶ In a car wash

Mercedes-Benz recommends transporting your vehicle in the case of a breakdown, rather than towing it away.

For towing, use a tow rope or tow bar with both axles on the ground. Do not use tow bar systems.

! NOTE Damage to the vehicle due to towing away incorrectly

- ▶ Observe the instructions and notes on towing away.

### Vehicles with rear wheel drive

#### Permitted towing methods

Both axles on the ground	Yes, maximum 31 miles (50 km) at 31 mph (50 km/h)
Front axle raised	No
Rear axle raised	Yes, if the steering wheel is fixed in the center position with a steering wheel lock

**4MATIC vehicles****Permitted towing methods**

Both axles on the ground	Yes, maximum 31 miles (50 km) at 31 mph (50 km/h)
Front axle raised	No
Rear axle raised	No

**To tow with a raised axle:** towing should be performed by a towing company.

**Towing the vehicle with both axles on the ground**

- ▶ Observe the notes on the permitted towing methods (→ page 293).
- ▶ Make sure that the battery is connected and charged.

Observe the following points when the battery is discharged:

- The engine cannot be started

- The electric parking brake cannot be released or applied
- **Vehicles with automatic transmission:** The automatic transmission cannot be shifted to position **N** or **P**

**i** **Vehicles with automatic transmission:** If the automatic transmission cannot be shifted to position **N** or if the display does not show anything, transport the vehicle (→ page 295). A towing vehicle with lifting equipment is required for vehicle transportation.

**!** **NOTE** Damage due to towing away at excessively high speeds or over long distances

The drivetrain could be damaged when towing at excessively high speeds or over long distances.

- ▶ A towing speed of 30 mph (50 km/h) must not be exceeded.
- ▶ A towing distance of 30 miles (50 km) must not be exceeded.

**!** **WARNING** Risk of accident when towing a vehicle which is too heavy

If the vehicle to be tow-started or towed away is heavier than the permissible gross mass of your vehicle, the following situations can occur:

- The towing eye may become detached.
  - The vehicle/trailer combination may swerve or rollover.
- ▶ Before tow-starting or towing away, check if the vehicle to be tow-started or towed away exceeds the permissible gross mass.

If a vehicle must be tow-started or towed away, its permissible gross mass must not exceed the permissible gross mass of the towing vehicle.

- ▶ Information on the permissible gross mass of the vehicle can be found on the vehicle identification plate (→ page 335).
- ▶ **Vehicles with automatic transmission:** Do not open the driver's door or front passenger

door; the automatic transmission otherwise automatically shifts to position **P**.

- ▶ Install the towing eye (→ page 297).
- ▶ Fasten the towing device.

**!** **NOTE** Damage due to incorrect connection of the tow bar

- ▶ Only connect the tow rope or tow bar to the towing eyes.

- ▶ Deactivate the automatic locking mechanism (→ page 67).
- ▶ Do not activate the HOLD function.
- ▶ Deactivate the tow-away alarm (→ page 82).
- ▶ Deactivate Active Brake Assist (→ page 187).
- ▶ **Vehicles with automatic transmission:** Shift the automatic transmission to position **N**.
- ▶ Release the electric parking brake.

**!** **WARNING** Risk of accident due to limited safety-related functions during the towing process

Safety-related functions are limited or no longer available in the following situations:

- The vehicle is switched off.
- The brake system or power steering system is malfunctioning.
- The energy supply or the on-board electrical system is malfunctioning.

When your vehicle is towed away, significantly more effort may be required to steer and brake than is normally required.

- ▶ Use a tow bar.
- ▶ Make sure that the steering wheel can move freely before towing the vehicle away.

**!** **NOTE** Damage due to excessive tractive power

If you pull away sharply, the tractive power may be too high and the vehicles could be damaged.

- ▶ Pull away slowly and smoothly.

### Loading the vehicle for transport

- ▶ Observe the notes on towing away (→ page 294).
- ▶ Connect the towing device to the towing eye in order to load the vehicle.
- ▶ **Vehicles with automatic transmission:** Shift the automatic transmission to position **N**.
- ▶ **i Vehicles with automatic transmission:** The automatic transmission may be locked in position **P** in the event of damage to the electrical system. To shift to **N**, provide the on-board electrical system with power (→ page 291).
- ▶ Load the vehicle onto the transporter.

- ▶ **Vehicles with automatic transmission:** Shift the automatic transmission to position **P**.
- ▶ Use the electric parking brake to secure the vehicle against rolling away.
- ▶ Only secure the vehicle by the wheels.

#### Vehicles with ADS PLUS (Adaptive Damping System PLUS)

**⚠ WARNING** Risk of an accident when transporting vehicles with Adaptive Damping System PLUS

When transporting vehicles with Adaptive Damping System PLUS, the vehicle/trailer combination may begin to rock and start to skid.

- ▶ Load the vehicle correctly onto the transporter.
- ▶ Secure the vehicle on all four wheels with suitable tensioning straps.
- ▶ Do not exceed the maximum permissible speed of 35 mph (60 km/h) when transporting.

**!** **NOTE** Damage to the vehicle from securing it incorrectly

- ▶ After loading, the vehicle must be secured on all four wheels. Otherwise, the vehicle could be damaged.
- ▶ A minimum distance of 8 in (20 cm) upwards and 4 in (10 cm) downwards must be kept to the transport platform.

- ▶ Secure the vehicle on all four wheels after loading.

#### 4MATIC vehicles/vehicles with automatic transmission

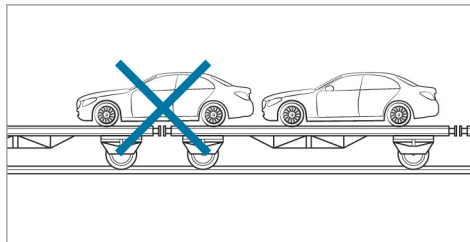

- ▶ Make sure that the front and rear axles come to rest on the same transportation vehicle.

**!** **NOTE** Damage to the drive train due to incorrect positioning of the vehicle

- ▶ Do not position the vehicle above the connection point of the transport vehicle.

#### Towing eye storage location

The towing eye is located in the stowage space under the trunk floor.

### Installing and removing the towing eye

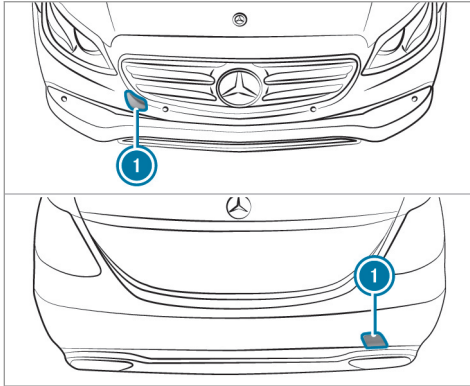

- ▶ Press the mark on cover ① inwards and remove. Depending on the vehicle version, it is necessary to take an additional step to unlock this by pressing on the side of the release clips. The cover beneath it can then be pulled forward and removed at the recess.

- ▶ Screw in the towing eye clockwise as far as it will go and tighten.
- ▶ Make sure that cover ① engages in the bumper when you remove the towing eye.

**!** **NOTE** Damage to the vehicle due to incorrect use of the towing eye or trailer hitch

When a towing eye or trailer hitch is used to recover a vehicle, the vehicle may be damaged in the process.

- ▶ Only use the towing eye or trailer hitch to tow away or tow start the vehicle.
- ▶ Do not use the towing eye or trailer hitch to tow the vehicle during recovery.

### Tow-starting the vehicle

#### Vehicles with automatic transmission

**!** **NOTE** Damage to the automatic transmission due to tow starting

The automatic transmission may be damaged in the process of tow starting vehicles with automatic transmission.

- ▶ Vehicles with automatic transmission must not be tow started.

- ▶ Vehicles with an automatic transmission must not be tow-started.

### Electrical fuses

#### Notes on electrical fuses

**!** **WARNING** Risk of accident and injury due to overloaded lines

If you manipulate or bridge a faulty fuse or if you replace it with a fuse with a higher amperage, the electric line could be overloaded.

This could result in a fire.

- ▶ Always replace faulty fuses with specified new fuses containing the correct amperage.

**!** **NOTE** Damage due to incorrect fuses

Electrical components or systems may be damaged by incorrect fuses, or their functionality may be significantly impaired.

- ▶ Only use fuses that have been approved by Mercedes-Benz and which have the correct fuse rating.

Blown fuses must be replaced with fuses of the same rating, which you can recognize by the color and the label. The fuse ratings and further information to be observed can be found in the fuse assignment diagram.

**Fuse assignment diagram:** on the fuse box in the trunk (→ page 300).

**!** **NOTE** Damage or malfunctions caused by moisture

Moisture may cause damage to the electrical system or cause it to malfunction.

- ▶ When the fuse box is open, make sure that no moisture can enter the fuse box.
- ▶ When closing the fuse box, make sure that the seal of the lid is positioned correctly on the fuse box.

If the newly inserted fuse also blows, have the cause traced and rectified at a qualified specialist workshop.

Ensure the following before replacing a fuse:

- The vehicle is secured against rolling away.
- All electrical consumers are switched off.
- The vehicle is switched off.

The electrical fuses are located in various fuse boxes:

- Fuse box in the engine compartment on the driver's side (→ page 298)

- Fuse box on the driver's side of the cockpit (→ page 299)
- Fuse box in the front passenger footwell (→ page 299)
- Fuse box in the trunk on the right-hand side of the vehicle, when viewed in the direction of travel (→ page 300)

### Opening and closing the fuse box in the engine compartment

**Requirements:**

- A dry cloth and a screwdriver are available.

Observe the notes on electrical fuses (→ page 297).

### Opening

**!** **WARNING** Risk of injury from using the windshield wipers when the hood is open

If the windshield wipers start moving when the hood is open, you could be trapped by the wiper linkage.

- ▶ Always switch off the windshield wipers and the vehicle first if you need to open the hood.

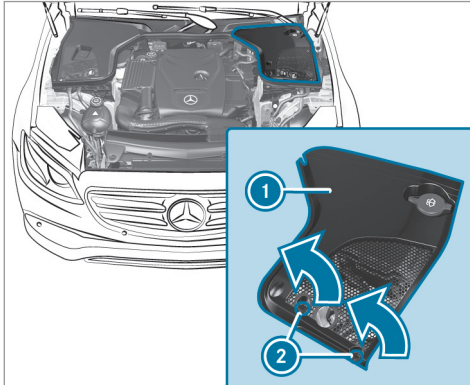

- ▶ Turn clips ② on cover ① a quarter-turn to counter-clockwise.
- ▶ Pull cover ① upwards in the direction of the arrow.

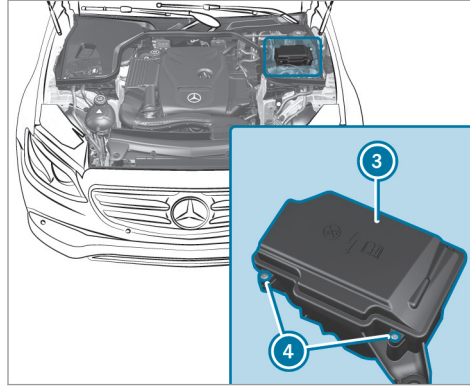

- ▶ Remove any existing moisture from the fuse box using a dry cloth.
- ▶ Loosen screws ④ and remove fuse box lid ③ from the top.

### Closing

- ▶ Check whether the seal is positioned correctly in cap ③.

- ▶ Insert lid ③ into the bracket at the rear of the fuse box.
- ▶ Fold down lid ③ of the fuse box and tighten screws ④.
- ▶ Insert cover ① on both sides.
- ▶ Turn clips ② on cover ① a quarter-turn clockwise.
- ▶ Close the hood.

### Opening and closing the fuse box in the cockpit

- Observe the notes on electrical fuses (→ page 297).

The fuse box is on the driver's side on the side of the cockpit under a cover.

- ▶ To open and close it, consult an authorized Mercedes-Benz Center.

### Opening and closing the fuse box in the front passenger footwell

Observe the notes on electrical fuses (→ page 297).

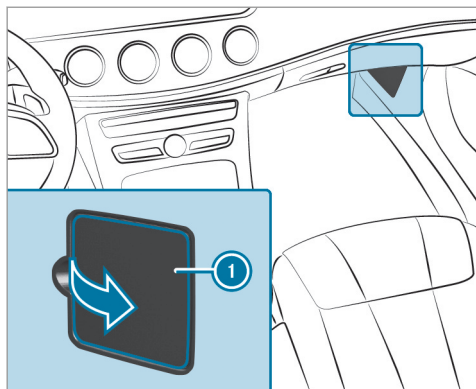

- ▶ **To open:** open cover ① in the direction of the arrow and remove it.
- ▶ **To close:** reinsert cover ①.

### Opening and closing the fuse box in the trunk

Observe the notes on electrical fuses  
(→ page 297).

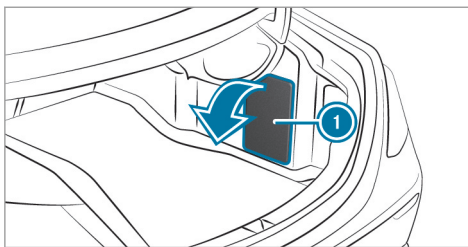

- ▶ Fold cover ① down in the direction of the arrow.

The fuse assignment diagram is in a recess on the side of the fuse box.



### Notes on noise or unusual handling characteristics

Make sure there are no vibrations, noises or unusual handling characteristics when the vehicle is in motion. This may indicate that the wheels or tires are damaged. Hidden tire damage could also be causing the unusual handling characteristics. If you suspect that a tire is malfunctioning, reduce your speed immediately and have the tires and wheels checked at a qualified specialist workshop.

### Notes on regularly inspecting wheels and tires

**⚠ WARNING** Risk of injury through damaged tires

Damaged tires can cause tire pressure loss.

- ▶ Check the tires regularly for signs of damage and replace any damaged tires immediately.

**⚠ WARNING** Risk of hydroplaning due to insufficient tire tread

Insufficient tire tread will result in reduced tire grip.

In heavy rain or slush the risk of hydroplaning is increased, in particular where speed is not adapted to suit the conditions.

- ▶ Thus, you should regularly check the tread depth and the condition of the tread across the entire width of all tires.

Minimum tread depth for:

- Summer tires:  $\frac{1}{8}$  in (3 mm)
- M+S tires:  $\frac{1}{16}$  in (4 mm)

- ▶ For safety reasons, replace the tires before the legally-prescribed limit for the minimum tread depth is reached.

Carry out the following checks on all wheels regularly, at least once a month or as required, for example, prior to a long journey or driving off-road:

- Check the tire pressure (→ page 302).

- Visually inspect wheels and tires for damage.
- Check the valve caps.
- Visual check of the tire tread depth and the tire contact surface across the entire width.

The minimum tread depth for summer tires is  $\frac{1}{8}$  in (3 mm) and for winter tires  $\frac{1}{16}$  in (4 mm).

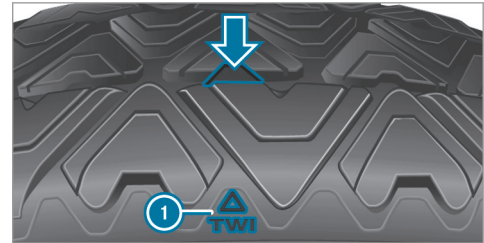

Six marks ① show where the bar indicators (arrow) are integrated into the tire tread. They are visible once a tire tread depth of approximately  $\frac{1}{16}$  in (1.6 mm) has been reached.

### Notes on snow chains

**⚠ WARNING** Risk of accident due to incorrectly installed snow chains

If you have installed snow chains on the front wheels, they may drag against the vehicle body or chassis components.

- ▶ Never install snow chains on the front wheels.
- ▶ Only install snow chains on the rear wheels in pairs.

**ℹ NOTE** Damage to components of the vehicle body or chassis due to mounted snow chains

If you mount snow chains to the front wheels of 4MATIC vehicles, you may damage components of the vehicle body or chassis.

- ▶ Only mount snow chains to the rear wheels of 4MATIC vehicles.

Observe the following notes when using snow chains:

- Snow chains are only permissible for certain wheel/tire combinations. You can obtain information about this from an authorized Mercedes-Benz Center.
  - For safety reasons, only use snow chains that have been specifically approved for your vehicle by Mercedes-Benz, or snow chains with the same quality standard.
  - If snow chains are installed, the maximum permissible speed is 30 mph (50 km/h).
  - **Vehicles with Active Parking Assist:** Do not use Active Parking Assist when snow chains are installed.
  - **Vehicles with level control:** If snow chains are installed, only drive at raised vehicle level (→ page 197).
- ℹ** You can deactivate ESP® to pull away (→ page 166). This allows the wheels to spin, achieving an increased driving force.

### Tire pressure

#### Notes on tire pressure

**⚠ WARNING** Risk of accident due to insufficient or excessive tire pressure

Underinflated or overinflated tires pose in particular the following risks:

- The tires can burst.
  - The tires can wear excessively and/or unevenly.
  - The driving characteristics as well as the steering and braking characteristics may be greatly impaired.
- ▶ Comply with the recommended tire pressures and check the tire pressure of all tires, including the spare wheel, regularly:
- Monthly
  - When the load changes
  - Before embarking on a longer journey

- If operating conditions change, e.g. off-road driving
- ▶ Adjust the tire pressure, if necessary.

Tire pressure which is too high or too low can:

- Shorten the service life of the tires.
- Cause increased tire damage.
- Adversely affect driving characteristics and thus driving safety, e.g. due to hydroplaning.

**⚠ WARNING** Risk of accident due to too low a tire pressure

Tires with pressure that is too low can overheat and burst as a consequence.

In addition, they also suffer from irregular wear, which can significantly impair the braking properties and the handling characteristics.

- ▶ Avoid excessively low tire pressure.

Tire pressure which is too low can cause:

- Tire malfunctions as a result of overheating

- Impaired handling characteristics
- Irregular wear
- Increased fuel consumption

**⚠ WARNING** Risk of accident due to too high a tire pressure

Tires with excessively high pressure can burst. In addition, they also suffer from irregular wear, which can significantly impair the braking properties and the handling characteristics.

- ▶ Avoid excessively high tire pressures.

Tire pressure which is too high can cause:

- Increased braking distance
- Impaired handling characteristics
- Irregular wear
- Impaired driving comfort
- Susceptibility to damage

**⚠ WARNING** Risk of accident due to repeated pressure drop in the tires

The wheels, valves or tires could be damaged. Too low a tire pressure can lead to the tires bursting.

- ▶ Examine the tires for foreign objects.
- ▶ Check whether the tire has a puncture or the valve has a leak.
- ▶ If you are unable to rectify the damage, contact a qualified specialist workshop.

You can find information on tire pressure for the vehicle's factory-installed tires on the following labels:

- Tire and Loading Information placard on the B-pillar of your vehicle (→ page 308).
- Tire pressure table on the inside of the fuel filler flap (→ page 304).

Observe the maximum tire pressure (→ page 315).

Use a suitable pressure gauge to check the tire pressure. The outer appearance of a tire does not

permit any reliable conclusion about the tire pressure.

Only correct tire pressure when the tires are cold. Conditions for cold tires:

- The vehicle has been parked with the tires out of direct sunlight for at least three hours.
- The vehicle has traveled less than 1 mile (1.6 km).

The vehicle's tires heat up when driving. As the temperature of the tires increases, so too does the tire pressure.

#### Vehicles with a tire pressure monitoring system:

You can also check the tire pressure using the on-board computer.

The tire pressure recommended for increased load/speed in the tire pressure table can affect the ride comfort.

**⚠ WARNING** Risk of accident due to unsuitable accessories on tire valves

If you mount unsuitable accessories onto tire valves, the tire valves may be overloaded and

malfunction, which can cause tire pressure loss.

- ▶ Only screw standard valve caps or valve caps specifically approved by Mercedes-Benz for your vehicle onto the tire valve.

#### Tire pressure table

The tire pressure table is on the inside of the fuel filler flap.

- ⓘ The data shown in the images is example data.

COLD TIRE PRESSURE	
normal load	2.3 bar / 33 psi
maximum load	2.5 bar / 36 psi
Warm tires up to: + 4 psi	

Technical codes: A 212 584 00 15, 1234567

If one or more tire sizes precede a tire pressure, the following tire pressure information is only valid for those tire sizes and their respective load condition.

The load conditions "partially laden" and "fully laden" are defined in the table for different numbers of passengers and amounts of luggage. The actual number of seats may differ from this.

		100 kPa = 1 bar		
		kPa	psi	kPa
R18	1 passenger	2.3	33	2.5
R18	2 passengers	2.3	33	2.5
R18	3 passengers	2.3	33	2.5
R18	4 passengers	2.3	33	2.5
R18	5 passengers	2.3	33	2.5
R18	6 passengers	2.3	33	2.5
R18	7 passengers	2.3	33	2.5
R18	8 passengers	2.3	33	2.5
R18	9 passengers	2.3	33	2.5
R18	10 passengers	2.3	33	2.5
R18	11 passengers	2.3	33	2.5
R18	12 passengers	2.3	33	2.5
R18	13 passengers	2.3	33	2.5
R18	14 passengers	2.3	33	2.5
R18	15 passengers	2.3	33	2.5
R18	16 passengers	2.3	33	2.5
R18	17 passengers	2.3	33	2.5
R18	18 passengers	2.3	33	2.5
R18	19 passengers	2.3	33	2.5
R18	20 passengers	2.3	33	2.5
R18	21 passengers	2.3	33	2.5
R18	22 passengers	2.3	33	2.5
R18	23 passengers	2.3	33	2.5
R18	24 passengers	2.3	33	2.5
R18	25 passengers	2.3	33	2.5
R18	26 passengers	2.3	33	2.5
R18	27 passengers	2.3	33	2.5
R18	28 passengers	2.3	33	2.5
R18	29 passengers	2.3	33	2.5
R18	30 passengers	2.3	33	2.5
R18	31 passengers	2.3	33	2.5
R18	32 passengers	2.3	33	2.5
R18	33 passengers	2.3	33	2.5
R18	34 passengers	2.3	33	2.5
R18	35 passengers	2.3	33	2.5
R18	36 passengers	2.3	33	2.5
R18	37 passengers	2.3	33	2.5
R18	38 passengers	2.3	33	2.5
R18	39 passengers	2.3	33	2.5
R18	40 passengers	2.3	33	2.5
R18	41 passengers	2.3	33	2.5
R18	42 passengers	2.3	33	2.5
R18	43 passengers	2.3	33	2.5
R18	44 passengers	2.3	33	2.5
R18	45 passengers	2.3	33	2.5
R18	46 passengers	2.3	33	2.5
R18	47 passengers	2.3	33	2.5
R18	48 passengers	2.3	33	2.5
R18	49 passengers	2.3	33	2.5
R18	50 passengers	2.3	33	2.5
R18	51 passengers	2.3	33	2.5
R18	52 passengers	2.3	33	2.5
R18	53 passengers	2.3	33	2.5
R18	54 passengers	2.3	33	2.5
R18	55 passengers	2.3	33	2.5
R18	56 passengers	2.3	33	2.5
R18	57 passengers	2.3	33	2.5
R18	58 passengers	2.3	33	2.5
R18	59 passengers	2.3	33	2.5
R18	60 passengers	2.3	33	2.5
R18	61 passengers	2.3	33	2.5
R18	62 passengers	2.3	33	2.5
R18	63 passengers	2.3	33	2.5
R18	64 passengers	2.3	33	2.5
R18	65 passengers	2.3	33	2.5
R18	66 passengers	2.3	33	2.5
R18	67 passengers	2.3	33	2.5
R18	68 passengers	2.3	33	2.5
R18	69 passengers	2.3	33	2.5
R18	70 passengers	2.3	33	2.5
R18	71 passengers	2.3	33	2.5
R18	72 passengers	2.3	33	2.5
R18	73 passengers	2.3	33	2.5
R18	74 passengers	2.3	33	2.5
R18	75 passengers	2.3	33	2.5
R18	76 passengers	2.3	33	2.5
R18	77 passengers	2.3	33	2.5
R18	78 passengers	2.3	33	2.5
R18	79 passengers	2.3	33	2.5
R18	80 passengers	2.3	33	2.5
R18	81 passengers	2.3	33	2.5
R18	82 passengers	2.3	33	2.5
R18	83 passengers	2.3	33	2.5
R18	84 passengers	2.3	33	2.5
R18	85 passengers	2.3	33	2.5
R18	86 passengers	2.3	33	2.5
R18	87 passengers	2.3	33	2.5
R18	88 passengers	2.3	33	2.5
R18	89 passengers	2.3	33	2.5
R18	90 passengers	2.3	33	2.5
R18	91 passengers	2.3	33	2.5
R18	92 passengers	2.3	33	2.5
R18	93 passengers	2.3	33	2.5
R18	94 passengers	2.3	33	2.5
R18	95 passengers	2.3	33	2.5
R18	96 passengers	2.3	33	2.5
R18	97 passengers	2.3	33	2.5
R18	98 passengers	2.3	33	2.5
R18	99 passengers	2.3	33	2.5
R18	100 passengers	2.3	33	2.5
R18	101 passengers	2.3	33	2.5
R18	102 passengers	2.3	33	2.5
R18	103 passengers	2.3	33	2.5
R18	104 passengers	2.3	33	2.5
R18	105 passengers	2.3	33	2.5
R18	106 passengers	2.3	33	2.5
R18	107 passengers	2.3	33	2.5
R18	108 passengers	2.3	33	2.5
R18	109 passengers	2.3	33	2.5
R18	110 passengers	2.3	33	2.5
R18	111 passengers	2.3	33	2.5
R18	112 passengers	2.3	33	2.5
R18	113 passengers	2.3	33	2.5
R18	114 passengers	2.3	33	2.5
R18	115 passengers	2.3	33	2.5
R18	116 passengers	2.3	33	2.5
R18	117 passengers	2.3	33	2.5
R18	118 passengers	2.3	33	2.5
R18	119 passengers	2.3	33	2.5
R18	120 passengers	2.3	33	2.5
R18	121 passengers	2.3	33	2.5
R18	122 passengers	2.3	33	2.5
R18	123 passengers	2.3	33	2.5
R18	124 passengers	2.3	33	2.5
R18	125 passengers	2.3	33	2.5
R18	126 passengers	2.3	33	2.5
R18	127 passengers	2.3	33	2.5
R18	128 passengers	2.3	33	2.5
R18	129 passengers	2.3	33	2.5
R18	130 passengers	2.3	33	2.5
R18	131 passengers	2.3	33	2.5
R18	132 passengers	2.3	33	2.5
R18	133 passengers	2.3	33	2.5
R18	134 passengers	2.3	33	2.5
R18	135 passengers	2.3	33	2.5
R18	136 passengers	2.3	33	2.5
R18	137 passengers	2.3	33	2.5
R18	138 passengers	2.3	33	2.5
R18	139 passengers	2.3	33	2.5
R18	140 passengers	2.3	33	2.5
R18	141 passengers	2.3	33	2.5
R18	142 passengers	2.3	33	2.5
R18	143 passengers	2.3	33	2.5
R18	144 passengers	2.3	33	2.5
R18	145 passengers	2.3	33	2.5
R18	146 passengers	2.3	33	2.5
R18	147 passengers	2.3	33	2.5
R18	148 passengers	2.3	33	2.5
R18	149 passengers	2.3	33	2.5
R18	150 passengers	2.3	33	2.5
R18	151 passengers	2.3	33	2.5
R18	152 passengers	2.3	33	2.5
R18	153 passengers	2.3	33	2.5
R18	154 passengers	2.3	33	2.5
R18	155 passengers	2.3	33	2.5
R18	156 passengers	2.3	33	2.5
R18	157 passengers	2.3	33	2.5
R18	158 passengers	2.3	33	2.5
R18	159 passengers	2.3	33	2.5
R18	160 passengers	2.3	33	2.5
R18	161 passengers	2.3	33	2.5
R18	162 passengers	2.3	33	2.5
R18	163 passengers	2.3	33	2.5
R18	164 passengers	2.3	33	2.5
R18	165 passengers	2.3	33	2.5
R18	166 passengers	2.3	33	2.5
R18	167 passengers	2.3	33	2.5
R18	168 passengers	2.3	33	2.5
R18	169 passengers	2.3	33	2.5
R18	170 passengers	2.3	33	2.5
R18	171 passengers	2.3	33	2.5
R18	172 passengers	2.3	33	2.5
R18	173 passengers	2.3	33	2.5
R18	174 passengers	2.3	33	2.5
R18	175 passengers	2.3	33	2.5
R18	176 passengers	2.3	33	2.5
R18	177 passengers	2.3	33	2.5
R18	178 passengers	2.3	33	2.5
R18	179 passengers	2.3	33	2.5
R18	180 passengers	2.3	33	2.5
R18	181 passengers	2.3	33	2.5
R18	182 passengers	2.3	33	2.5
R18	183 passengers	2.3	33	2.5
R18	184 passengers	2.3	33	2.5
R18	185 passengers	2.3	33	2.5
R18	186 passengers	2.3	33	2.5
R18	187 passengers	2.3	33	2.5
R18	188 passengers	2.3	33	2.5
R18	189 passengers	2.3	33	2.5
R18	190 passengers	2.3	33	2.5
R18	191 passengers	2.3	33	2.5
R18	192 passengers	2.3	33	2.5
R18	193 passengers	2.3	33	2.5
R18	194 passengers	2.3	33	2.5
R18	195 passengers	2.3	33	2.5
R18	196 passengers	2.3	33	2.5
R18	197 passengers	2.3	33	2.5
R18	198 passengers	2.3	33	2.5
R18	199 passengers	2.3	33	2.5
R18	200 passengers	2.3	33	2.5
R18	201 passengers	2.3	33	2.5
R18	202 passengers	2.3	33	2.5
R18	203 passengers	2.3	33	2.5
R18	204 passengers	2.3	33	2.5
R18	205 passengers	2.3	33	2.5
R18	206 passengers	2.3	33	2.5
R18	207 passengers	2.3	33	2.5
R18	208 passengers	2.3	33	2.5
R18	209 passengers	2.3	33	2.5
R18	210 passengers	2.3	33	2.5
R18	211 passengers	2.3	33	2.5
R18	212 passengers	2.3	33	2.5
R18	213 passengers	2.3	33	2.5
R18	214 passengers	2.3	33	2.5
R18	215 passengers	2.3	33	2.5
R18	216 passengers	2.3	33	2.5
R18	217 passengers	2.3	33	2.5
R18	218 passengers	2.3	33	2.5
R18				

Some tire pressure tables only show the rim diameter instead of the complete tire size, e.g. **R18**. The rim diameter is part of the tire size and can be found on the tire side wall (→ page 316).

- Tire and Loading Information placard (→ page 308)
- Maximum tire pressure (→ page 315)

### Checking the tire pressure manually

- ▶ Read the tire pressure recommended for the current operating conditions from the Tire and Loading Information placard or the tire pressure table. Observe the notes on tire pressure.
- ▶ Remove the valve cap of the tire to be checked.
- ▶ Press the tire pressure gauge securely onto the valve.
- ▶ Read the tire pressure.
- ▶ If the tire pressure is lower than the recommended value, increase the tire pressure to the recommended value.

- ▶ If the tire pressure is higher than the recommended value, release air. To do so, press down the metal pin in the valve, e.g. using the tip of a pen. Then, check the tire pressure again using the tire pressure gauge.
- ▶ Screw the valve cap onto the valve.

Further related subjects:

- Notes on tire pressure (→ page 302)
- Tire pressure table (→ page 304)
- Tire and Loading Information placard (→ page 308)

### Tire pressure monitoring system

#### Function of the tire pressure monitoring system

**⚠ DANGER** Risk of accident due to incorrect tire pressure

Each tire, including the spare (if provided), should be checked monthly when cold and inflated to the inflation pressure recommended by the vehicle manufacturer on the vehicle placard or tire inflation pressure label. (If

your vehicle has tires of a different size than the size indicated on the vehicle placard or tire inflation pressure label, you should determine the proper tire inflation pressure for those tires.)

As an added safety feature, your vehicle has been equipped with a tire pressure monitoring system (TPMS) that illuminates a low tire pressure telltale when one or more of your tires is significantly under-inflated. Accordingly, when the low tire pressure telltale illuminates, you should stop and check your tires as soon as possible, and inflate them to the proper pressure. Driving on a significantly under-inflated tire causes the tire to overheat and can lead to tire failure. Under-inflation also reduces fuel efficiency and tire tread life, and may affect the vehicle's handling and stopping ability. Please note that the TPMS is not a substitute for proper tire maintenance, and it is the driver's responsibility to maintain correct tire pressure, even if under-inflation has not reached the level to trigger illumination of the TPMS low tire pressure telltale.

Your vehicle has also been equipped with a TPMS malfunction indicator to indicate when the system is not operating properly. The TPMS malfunction indicator is combined with the low tire pressure telltale. When the system detects a malfunction, the telltale will flash for approximately one minute and then remain continuously illuminated. This sequence will continue upon subsequent vehicle start-ups as long as the malfunction exists.

When the malfunction indicator is illuminated, the system may not be able to detect or signal low tire pressure as intended. TPMS malfunctions may occur for a variety of reasons, including the installation of replacement or alternate tires or wheels on the vehicle that prevent the TPMS from functioning properly.

The system checks the tire pressure and the tire temperature of the tires installed on the vehicle by means of a tire pressure sensor.

The tire pressure and the tire temperature appear in the on-board computer (→ page 306).

If there is a substantial pressure loss or if the tire temperature is excessive, you will be warned with display messages (→ page 390) or the  warning lamp in the instrument cluster (→ page 411).

The tire pressure monitoring system is only an aid. It is the driver's responsibility to set the tire pressure to the recommended cold tire pressure suitable for the operating situation.

In most cases, the tire pressure monitoring system will automatically update the new reference values after you have changed the tire pressure. You can, however, also update the reference values by restarting the tire pressure monitoring system manually (→ page 307).

### System limits

The system may be impaired or may not function particularly in the following situations:

- Incorrect reference values were taught in
- Sudden pressure loss caused by a foreign object penetrating the tire, for example
- There is a malfunction caused by another radio signal source

### Checking the tire pressure with the tire pressure monitoring system

#### Requirements:

- The vehicle is switched on.

On-board computer:

 [Service](#)  [Tires](#)

One of the following displays appears:

- Current tire pressure and tire temperature of the individual wheels:

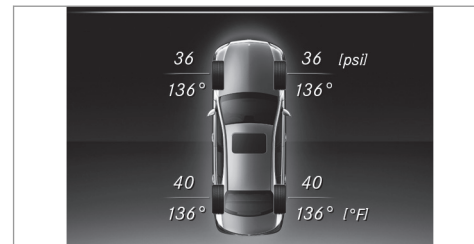

- [Tire pressure will be displayed after driving a few minutes](#)

- **Tire Pressure Monitor Active:** the teach-in process of the system is not yet complete. The tire pressures are already being monitored.
- ▶ Compare the tire pressure with the recommended tire pressure for the current operating condition (→ page 304). Additionally, observe the notes on cold tires (→ page 302).
- ⓘ The values displayed in the on-board computer may deviate from those of the tire pressure gauge as they refer to sea level. At high elevations, the tire pressure values indicated by a pressure gauge are higher than those shown by the on-board computer. In this case, do not reduce the tire pressure.

### Restarting the tire pressure monitoring system

#### Requirements:

- The recommended tire pressure is correctly set for the respective operating status on all of the wheels (→ page 302).

Restart the tire pressure monitoring system in the following situations:

- The tire pressure has changed.

- The wheels or tires have been changed or newly installed.

On-board computer:

↪ Service ▶▶ Tires

- ▶ Swipe downwards on Touch Control on the left-hand side of the steering wheel. The **Use Current Pressures as New Reference Values** message is shown in the Instrument Display.
- ▶ To restart, press Touch Control on the left-hand side of the steering wheel. The **Tire Press. Monitor Restarted** message is shown in the Instrument Display.
- Current warning messages are deleted and the yellow  warning lamp goes out.
- After you have been driving for a few minutes, the system checks whether the current tire pressures are within the specified range. The current tire pressures are then accepted as reference values and monitored.

Be sure to also pay attention to the following related topic:

- Notes on tire pressure (→ page 302)

### Tire pressure loss warning system

#### Function of the tire pressure loss warning system

The tire pressure loss warning system warns the driver by means of display messages when there is a severe tire pressure loss.

#### System limits

The system may be impaired or may not function particularly in the following situations:

- Incorrect reference values were taught in
- Sudden pressure loss caused by a foreign object penetrating the tire, for example
- An even pressure loss on more than one tire occurs

The system has a restricted or delayed function particularly in the following situations:

- Poor ground conditions, e.g. snow or gravel
- Driving with snow chains
- When adopting a very sporty driving style with high cornering speeds or sudden acceleration
- Driving with a high load

The tire pressure loss warning system is only an aid. It is the driver's responsibility to set the tire pressure to the recommended cold tire pressure suitable for the operating situation and to check it.

Be sure to also observe the following further related subjects:

- Notes on tire pressure (→ page 302)
- Display messages about the tires (→ page 390)

### Restarting the tire pressure loss warning system

#### Requirements:

- The recommended tire pressure is correctly set for the respective operating status on all wheels.

Restart the tire pressure loss warning system in the following situations:

- The tire pressure has changed.
- The wheels or tires have been changed or newly installed.

On-board computer:

#### ↳ Service ▶ Tires

- ▶ Swipe downwards on the Touch Control on the left-hand side of the steering wheel. The **Tire Pressure Control System Active Restart** message is shown in the display.
- ▶ To begin restart, press the Touch Control on the left-hand side of the steering wheel. The **Tire Pressure Now OK?** message is shown in the display.
- ▶ Select **Yes**.
- ▶ To confirm restart, press the Touch Control on the left-hand side of the steering wheel. The **Run Flat Indicator Restarted** message is shown in the display.

After you have driven for a few minutes, the tire pressure loss warning system monitors the set tire pressures of all the tires.

Be sure to also pay attention to the following related topic:

- Notes on tire pressure (→ page 302)

### Loading the vehicle

#### Notes on Tire and Loading Information placard

**⚠ WARNING** Risk of accident from overloaded tires

Overloaded tires may overheat and burst as a consequence. Overloaded tires can also impair the steering and handling characteristics and lead to brake failure.

- ▶ Observe the load rating of the tires.
- ▶ The load rating must be at least half the permissible axle load of the vehicle.
- ▶ Never overload the tires by exceeding the maximum load.

The Tire and Loading Information placard is on the B-pillar on the driver's side of the vehicle.



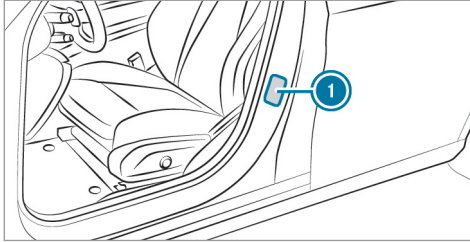

1 Tire and Loading Information placard

TIRE AND LOADING INFORMATION RENSEIGNEMENTS POUR LES PNEUS ET LE CHARGEMENT				
SEATING CAPACITY NOMBRE DE PLACES	TOTAL 7	FRONT AVANT 2	MIDDLE MIEU 3	REAR ARRIÈRE 2
The combined weight of occupants and cargo should never exceed XXX kg or XXX lbs. Le poids total des occupants et du chargement ne doit jamais dépasser XXX kg ou XXX lbs.*				
TIRE PNEU	SIZE DIMENSIONS	COLD TIRE PRESSURE PRESSION DES PNEUS À FROID		SEE OWNER'S MANUAL FOR ADDITIONAL INFORMATION
FRONT AVANT	255/40 ZR18 99Y XL	200 KPA, 29 PSI		VOIR LE MANUEL DE L'USAGER POUR PLUS DE RENSEIGNEMENTS
REAR ARRIÈRE	285/35 ZR18 101Y XL	200 KPA, 29 PSI		
SPARE DE SECOURS	175/55-18 95P	420 KPA, 60 PSI		

i The data shown in the illustration is example data.

The Tire and Loading Information placard shows the following information:

- Maximum number of seats 2 according to the maximum number of people permitted to travel in the vehicle.

- Maximum permissible load 3 comprises the gross weight of all vehicle occupants, load and luggage.
- Recommended tire pressure 1 for cold tires. The recommended tire pressures are valid for the maximum permissible load and up to the maximum permissible vehicle speed.

Please also note:

- Information on permissible weights and loads on the vehicle identification plate (→ page 335).
- Information on tire pressure in the tire pressure table (→ page 304).

Further related subjects:

- Determining the maximum permissible load (→ page 309)
- Notes on tire pressure (→ page 302).

### Steps for Determining Correct Load Limit

The following steps have been developed as required of all manufacturers under Title 49, Code of U.S. Federal Regulations, Part 575, pursuant to

the "National Traffic and Motor Vehicle Safety Act of 1966".

- ▶ **(1):** Locate the statement "The combined weight of occupants and cargo should never exceed XXX kg or XXX lbs." on your vehicle's placard.
- ▶ **(2):** Determine the combined weight of the driver and passengers that will be riding in your vehicle.
- ▶ **(3):** Subtract the combined weight of the driver and passengers from XXX kg or XXX lbs.
- ▶ **(4):** The resulting figure equals the available amount of cargo and luggage load capacity. For example, if the "XXX" amount equals 1,400 lbs. and there will be five 150 lb passengers in your vehicle, the amount of available cargo and luggage load capacity is 650 lbs. (1,400 - 750 (5 x 150) = 650 lbs.)
- ▶ **(5):** Determine the combined weight of luggage and cargo being loaded on the vehicle. That weight may not safely exceed the availa-

ble cargo and luggage load capacity calculated in Step 4.

- ▶ **(6):** If your vehicle will be towing a trailer, load from your trailer will be transferred to your vehicle. Consult this manual to determine how this reduces the available cargo and luggage load capacity of your vehicle.
- ⓘ Not all vehicles are permitted to tow a trailer. Towing a trailer is only permitted if a trailer-hitch is installed. Please consult an authorized Mercedes-Benz dealer if you have any questions about towing a trailer with your vehicle.

Even if you have calculated the total load carefully, you should still make sure that the maximum permissible gross weight and the maximum gross axle weight rating of your vehicle are not exceeded. Details can be found on the vehicle identification plate.

- ▶ Have your loaded vehicle – including driver, occupants and load – weighed on a vehicle weighbridge. The measured values may not exceed the maximum permissible values stated on the vehicle identification plate.

Further related subjects:

- Calculation example for determining the maximum load (→ page 310)
- Tire and Loading Information placard (→ page 308)
- Tire pressure table (→ page 304)
- Vehicle identification plate (→ page 335)

#### Calculation example for determining the maximum load

The following table shows examples of how to calculate total and load capacities with varying seating configurations and different numbers and sizes of occupants. The following examples use a maximum load of 1500 lbs (680 kg). **This is for illustration purposes only.** Make sure you are using the actual load limit for your vehicle stated on your vehicle's Tire and Loading Information placard (→ page 308).

The higher the weight of all the occupants, the smaller the maximum load for luggage.

**Step 1**

	Example 1	Example 2
Combined maximum weight of occupants and load (data from the Tire and Loading Information placard)	1500 lbs (680 kg)	1500 lbs (680 kg)

**Step 2**

	Example 1	Example 2
Number of people in the vehicle (driver and occupants)	5	1
Distribution of the occupants	Front: 2 Rear: 3	Front: 1
Weight of occupants	Occupant 1: 150 lbs (68 kg) Occupant 2: 180 lbs (82 kg) Occupant 3: 160 lbs (73 kg) Occupant 4: 140 lbs (63 kg) Occupant 5: 120 lbs (54 kg)	Occupant 1: 200 lbs (91 kg)
Total weight of all occupants	750 lbs (340 kg)	200 lbs (91 kg)

## 312 Wheels and tires

---

### Step 3

	Example 1	Example 2
Permissible load (maximum gross vehicle weight rating from the Tire and Loading Information placard minus the gross weight of all occupants)	1500 lbs (680 kg) - 750 lbs (340 kg) = 750 lbs (340 kg)	1500 lbs (680 kg) - 200 lbs (91 kg) = 1300 lbs (589 kg)

## Tire labeling

### Overview of tire labeling

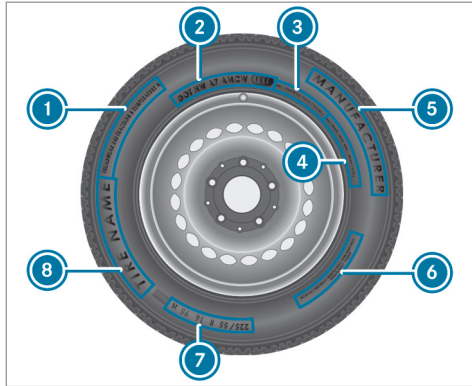

- ① Uniform Tire Quality Grading Standards
- ② DOT (Department of Transportation), (TIN) Tire Identification Number
- ③ Maximum tire load (→ page 315)
- ④ Maximum tire pressure (→ page 315)

- ⑤ Manufacturer
- ⑥ Tire characteristics (→ page 316)
- ⑦ Tire size designation, load-bearing capacity, speed rating and load index (→ page 316)
- ⑧ Tire name
- ⑨ The data shown in the illustration is example data.

### Tire Quality Grading

In accordance with the US Department of Transportation's "Uniform Tire Quality Grading Standards", tire manufacturers are required to grade their tires on the basis of the following three performance factors:

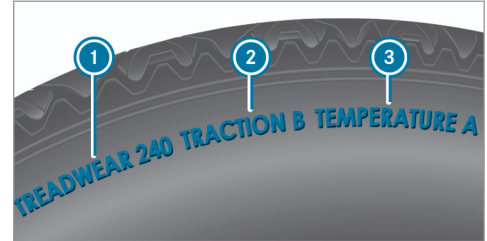

- ① Tread wear grade
- ② Traction grade
- ③ Temperature grade
- ④ The data shown in the illustration is example data.
- ⑤ The classification is not legally stipulated for Canada, but it is generally stated.

### Tread wear grade

The treadwear grade is a comparative rating based on the wear rate of the tire when tested under controlled conditions on a specified government test course. For example, a tire graded 150 would wear one and one-half (1\1/2) times as

## 314 Wheels and tires

well on the government course as a tire graded 100.

The relative performance of tires depends upon the actual conditions of their use, however, and may depart significantly from the norm due to variations in driving habits, service practices and differences in road characteristics and climate.

### Traction grade

**⚠ DANGER** Risk of accident due to inadequate traction

The traction grade assigned to this tire is based on straight-ahead braking traction tests.

- ▶ Always adapt your driving style and drive at a speed to suit the prevailing traffic and weather conditions.

**❗ NOTE** Damage to the drivetrain from wheelspin

- ▶ Avoid wheelspin.

The traction grades, from highest to lowest, are AA, A, B, and C. Those grades represent the tire's ability to stop on wet pavement as measured under controlled conditions on specified government test surfaces of asphalt and concrete. A tire marked C may have poor traction performance.

### Temperature grade

**⚠ WARNING** Risk of accident from tire overheating and tire failure

Excessive speed, underinflation, or excessive loading, either separately or in combination, can cause excessive heat build-up and possible tire failure.

- ▶ Observe the recommended tire pressure.
- ▶ Regularly check the pressure of all the tires.
- ▶ Adjust the tire pressure, if necessary.

The temperature grades are A (the highest), B, and C, representing the tire's resistance to the generation of heat and its ability to dissipate heat when tested under controlled conditions on a specified indoor laboratory test wheel. Sustained

high temperature can cause the material of the tire to degenerate and reduce tire life, and excessive temperature can lead to sudden tire failure. The grade C corresponds to a level of performance which all passenger car tires must meet under the Federal Motor Safety Standard No. 109. Grades B and A represent higher levels of performance on the laboratory test wheel than the minimum required by law.

### DOT, Tire Identification Number (TIN)

US tire regulations stipulate that every tire manufacturer or retreader must imprint a TIN in or on the side wall of each tire produced.



**i** The data shown in the image is example data. The TIN is a unique identification number to identify tires and comprises the following:

- **DOT (Department of Transportation):** tire symbol marks **1** indicating that the tire complies with the requirements of the US Department of Transportation.
- **Manufacturer identification code:** manufacturer identification code **2** contains details of the tire manufacturer. New tires have a code with two symbols. Retreaded tires have a code with four symbols. Further information on retreaded tires (→ page 320).
- **Tire size:** identifier **3** describes the tire size.
- **Tire type code:** tire type code **4** can be used by the manufacturer as a code to describe specific characteristics of the tire.
- **Manufacturing date:** manufacturing date **5** provides information about the age of a tire. The 1st and 2nd positions represent the calendar week and the 3rd and 4th positions state the year of manufacture (e.g. "3208" represents the 32nd week of 2008).

### Information on the maximum tire load



**i** The data shown in the image is example data. Maximum tire load **1** is the maximum permissible weight for which the tire is approved. Do not overload the tires by exceeding the specified load limit. The maximum permissible load can be found on the vehicle's Tire and Loading Information placard on the B-pillar on the driver's side (→ page 308).

### Specifications for maximum tire pressure

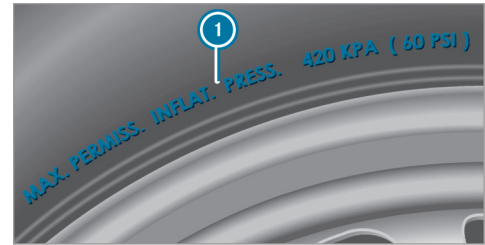

**i** The data shown in the illustration is example data. Never exceed maximum tire pressure **1** specified for the tire. Always observe the recommended tire pressure for your vehicle when adjusting the tire pressure (→ page 304).

### Information on tire characteristics



**i** The data shown in the image is example data. This information describes the type of tire cord and the number of layers in side wall **1** and under tire tread **2**.

### Tire size designation, load-bearing capacity, speed rating and load index

**⚠ WARNING** Risk of injury through exceeding the specified tire load-bearing capacity or the permissible speed rating

Exceeding the specified tire load rating or the permissible speed rating may lead to tire damage and to the tires bursting.

- ▶ Therefore, only use tire types and sizes approved for your vehicle model.
- ▶ Observe the tire load rating and speed rating required for your vehicle.

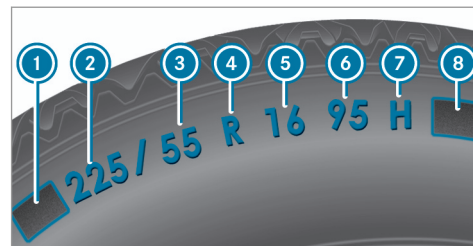

- 1** First letter(s)
- 2** Nominal tire width in millimeters
- 3** Aspect ratio in %
- 4** Tire code
- 5** Rim diameter
- 6** Load-bearing index
- 7** Speed rating
- 8** Load index

**i** The data shown in the illustration is example data.

Information about reading tire data can be obtained from any qualified specialist workshop.



**First letter(s) 1:**

- Without: passenger vehicle tires according to European manufacturing standards.
- "P": passenger vehicle tires according to US manufacturing standards.
- "LT": light truck tires according to US manufacturing standards.
- "T": compact emergency spare wheels with high tire pressure that are only designed for temporary use in an emergency.

**Aspect ratio 3:**

Ratio between tire height and tire width in percent (tire height divided by tire width).

**Tire code 4 (tire type):**

- "R" radial tire
- "D": bias ply tire
- "B": bias belted tires
- "ZR": radial tire with a maximum speed above 149 mph (240 km/h) (optional)

**Rim diameter 5:**

The diameter of the bead seat (not the diameter of the rim flange). The rim diameter is specified in inches (in).

**Load-bearing index 6:**

Numerical code that specifies the maximum load-bearing capacity of a tire (e.g. "91" corresponds to 1356 lbs (615 kg)).

The load-bearing capacity of the tire must be at least half the gross axle weight rating of your vehicle. Do not overload the tires by exceeding the specified load limit.

See also:

- Maximum permissible load on the Tire and Loading Information placard (→ page 308)
- Maximum tire load (→ page 315)
- Load index

**Speed rating 7:**

Specifies the approved maximum speed of the tire.

- **i** An electronic speed limiter prevents your vehicle from exceeding a speed of 130 mph (210 km/h).

Make sure that your tires have the required speed rating. You can obtain information on the required speed rating from an authorized Mercedes-Benz Center.

**Summer tires**

Index	Speed rating
Q	up to 100 mph (160 km/h)
R	up to 106 mph (170 km/h)
S	up to 112 mph (180 km/h)
T	up to 118 mph (190 km/h)
H	up to 130 mph (210 km/h)
V	up to 149 mph (240 km/h)
W	up to 168 mph (270 km/h)
Y	up to 186 mph (300 km/h)

Index	Speed rating
ZR...Y <sup>1</sup>	up to 186 mph (300 km/h)
ZR...(..Y) <sup>1</sup>	over 186 mph (300 km/h)
ZR <sup>1</sup>	over 149 mph (240 km/h)

- Specifying the speed rating as the "ZR" index in tire code ④ is optional for tires up to 186 mph (300 km/h).
- If your tire code ④ includes "ZR" and there is no speed rating ⑦, find out what the maximum speed is from the tire manufacturer.
- If load-bearing index ⑥ and speed rating ⑦ are in brackets, the maximum speed rating of your tire is above 186 mph (300 km/h). To find out the maximum speed, ask the tire manufacturer.

<sup>1</sup> "ZR" stated in the tire code.

<sup>2</sup> Or "M+S"  for winter tires.

### All-weather tires and winter tires

Index	Speed rating
Q M+S <sup>2</sup>	up to 100 mph (160 km/h)
T M+S <sup>2</sup>	up to 118 mph (190 km/h)
H M+S <sup>2</sup>	up to 130 mph (210 km/h)
V M+S <sup>2</sup>	up to 149 mph (240 km/h)

Winter tires bear the  snowflake symbol and fulfill the requirements of the Rubber Manufacturers Association (RMA) and the Rubber Association of Canada (RAC) regarding the tire traction on snow.

### Load index ⑧:

- No specification given: standard load (SL) tire
- "XL" or "Extra Load": extra load tire or reinforced tire
- "Light Load": light load tire

- "C", "D", "E": a load range that depends on the maximum load that the tire can carry at a certain pressure

### Definition of terms for tires and loading

**Tire structure and characteristics:** describes the number of layers or the number of rubber-coated belts in the tire contact surface and the tire wall. These are made of steel, nylon, polyester and other materials.

**Bar:** metric unit for tire pressure. 14.5038 pounds per square inch (psi) and 100 kilopascal (kPa) is the equivalent of one bar.

**DOT (Department of Transportation):** DOT-marked tires fulfill the requirements of the US Department of Transportation.

**Average weight of the vehicle occupants:** the number of vehicle occupants for which the vehicle is designed, multiplied by 150 lb (68 kg).

**Uniform Tire Quality Grading Standards:** a uniform standard to grade the quality of tires with regard

to tread quality, tire traction and temperature characteristics. The quality grading assessment is made by the manufacturer following specifications from the U.S. government. The quality grade of a tire is imprinted on the side wall of the tire.

**Recommended tire pressure:** the recommended tire pressure is the tire pressure specified for the tires mounted to the vehicle at the factory.

The tire and information table contains the recommended tire pressures for cold tires, the maximum permissible load and the maximum permissible vehicle speed.

The tire pressure table contains the recommended tire pressures for cold tires under various operating conditions, i.e. loading and/or speed of the vehicle.

**Increased vehicle weight due to optional equipment:** the combined weight of all standard and optional equipment available for the vehicle, regardless of whether it is actually installed on the vehicle or not.

**Rim:** the part of the wheel on which the tire is installed.

**GAWR (Gross Axle Weight Rating):** the GAWR is the maximum permissible axle load. The actual load on an axle must never exceed the gross axle weight rating. The gross axle weight rating can be found on the vehicle identification plate on the B-pillar on the driver's side.

**Speed rating:** the speed rating is part of the tire identification. It specifies the speed range for which a tire is approved.

**GVW (Gross Vehicle Weight):** the gross vehicle weight comprises the weight of the vehicle including fuel, tools, the spare wheel, accessories installed, occupants, luggage and the trailer drawbar noseweight, if applicable. The gross vehicle weight must not exceed the gross vehicle weight rating GVWR as specified on the vehicle identification plate on the B-pillar on the driver's side.

**GVWR (Gross Vehicle Weight Rating):** the GVWR is the maximum permitted gross weight of the fully laden vehicle (weight of the vehicle including all accessories, occupants, fuel, luggage and the trailer drawbar noseweight if applicable). The gross vehicle weight rating is specified on the vehicle identification plate on the B-pillar on the driver's side.

**Maximum weight of the laden vehicle:** the maximum weight is the sum of the curb weight of the vehicle, the weight of the accessories, the maximum load and the weight of optional equipment installed at the factory.

**Kilopascal (kPa):** metric unit for tire pressure. 6.9 kPa corresponds to 1 psi. Another unit for tire pressure is bar. 100 kilopascal (kPa) equals 1 bar.

**Load index:** in addition to the load-bearing index, the load index may also be imprinted on the side wall of the tire. This specifies the load-bearing capacity of the tire more precisely.

**Curb weight:** the weight of a vehicle with standard equipment including the maximum capacity of fuel, oil and coolant. It also includes the air conditioning system and optional equipment if these are installed on the vehicle, but does not include passengers or luggage.

**Maximum tire load:** the maximum tire load is the maximum permissible weight in kilograms or lbs for which a tire is approved.

**Maximum permissible tire pressure:** maximum permissible tire pressure for one tire.

**Maximum load on one tire:** maximum load on one tire. This is calculated by dividing the maximum axle load of one axle by two.

**PSI (pounds per square inch):** standard unit of measurement for tire pressure.

**Aspect ratio:** ratio between tire height and tire width in percent.

**Tire pressure:** pressure inside the tire applying an outward force to every square inch of the tire. The tire pressure is specified in pounds per square inch (psi), in kilopascals (kPa) or in bar. The tire pressure should only be corrected when the tires are cold.

**Cold tire pressure:** the tires are cold when the vehicle has been parked for at least 3 hours without direct sunlight on the tires or the vehicle has been driven for less than 1 mile (1.6 km).

**Tire contact surface:** the part of the tire that comes into contact with the road.

**Tire bead:** the purpose of the tire bead is to ensure that the tire sits securely on the wheel rim. There are several wire cores in the tire bead to prevent the tire from changing length on the wheel rim.

**Side wall:** the part of the tire between the tread and the tire bead.

**Weight of optional equipment:** the combined weight of the optional equipment weighing more than the replaced standard parts and more than 5 lbs (2.3 kg). This optional equipment, such as high-performance brakes, level control system, a roof luggage rack or high-performance batteries, is not included in the curb weight and the weight of the accessories.

**TIN (Tire Identification Number):** a unique identification number which can be used by a tire manufacturer to identify tires, for example, in a product recall, and thus identify the purchasers. The TIN is made up of the manufacturer's identity code, tire size, tire type code and the manufacturing date.

**Load-bearing index:** the load-bearing index is a code that contains the maximum load-bearing capacity of a tire.

**Traction:** traction is the grip resulting from friction between the tires and the road surface.

**Wear indicator:** narrow bars (tread wear bars) that are distributed over the tire contact surface. If the

tire tread is level with the bars, the wear limit of 1/16 in (1.6 mm) has been reached.

**Distribution of vehicle occupants:** distribution of vehicle occupants over designated seat positions in a vehicle.

**Maximum permissible payload weight:** nominal load and luggage load plus 150 lb (68 kg) multiplied by the number of seats in the vehicle.

### Changing a wheel

#### Notes on selecting, installing and replacing tires

- !** **NOTE** Mercedes-AMG vehicles
  - ▶ Observe the notes in the Supplement. You could otherwise fail to recognize dangers.

- !** **WARNING** Risk of accident due to incorrect wheel and tire dimensions

If wheels and tires of the wrong size are installed, the service brakes or components in the

brake system and in the wheel suspension may be damaged.

- ▶ Always replace wheels and tires with ones that fulfill the specifications of the original part.

For wheels, pay attention to the following:

- Designation
- Type

For tires, pay attention to the following:

- Designation
- Manufacturer
- Type

**⚠ WARNING** Risk of injury through exceeding the specified tire load-bearing capacity or the permissible speed rating

Exceeding the specified tire load rating or the permissible speed rating may lead to tire damage and to the tires bursting.

- ▶ Therefore, only use tire types and sizes approved for your vehicle model.
- ▶ Observe the tire load rating and speed rating required for your vehicle.

**!** **NOTE** Vehicle and tire damage through tire types and sizes that have not been approved

For safety reasons, only use tires, wheels and accessories which have been specially approved by Mercedes-Benz for your vehicle.

These tires are specially adapted to the active safety systems, such as ABS, ESP® and 4MATIC, and marked as follows:

- MO = Mercedes-Benz Original
- MOE = Mercedes-Benz Original Extended (run-flat tire only for certain wheels)
- MO1 = Mercedes-Benz Original (only certain AMG tires)

Otherwise, certain properties, such as handling characteristics, vehicle noise emissions, consumption, etc. could be adversely affected.

Furthermore, other tire sizes could result in the tires rubbing against the body and axle components when loaded. This could result in damage to the tire or the vehicle.

Only use tires, wheels and accessories that have been checked and recommended by Mercedes-Benz.

**!** **NOTE** Risk to driving safety from retreaded tires

Retreaded tires are neither tested nor recommended by Mercedes-Benz, since previous damage cannot always be detected on retreaded tires.

For this reason driving safety cannot be guaranteed.

- ▶ Do not use used tires if you have no information about their previous usage.

**!** **NOTE** Possible wheel and tire damage when driving over obstacles

Large wheels have a smaller section width. As the section width decreases, the risk of wheels and tires being damaged when driving over obstacles increases.

- ▶ Avoid obstacles or drive especially carefully.
- ▶ Reduce your speed when driving over curbs, speed bumps, manhole covers and potholes.
- ▶ Avoid particularly high curbs.

**!** **NOTE** Possible wheel and tire damage when parking on curbs or in potholes

Parking on curbs or in potholes may damage the wheels and tires.

- ▶ If possible, park only on flat surfaces.
- ▶ Avoid curbs and potholes when parking.

**!** **NOTE** Damage to electronic component parts from the use of tire-mounting tools

**Vehicles with a tire pressure monitoring system:** Electronic component parts are located in the wheel. Tire-mounting tools should not be used in the area of the valve.

This could otherwise damage the electronic component parts.

- ▶ Have the tires changed at a qualified specialist workshop only.

**!** **NOTE** Damage to summer tires at low ambient temperatures

At low ambient temperatures, tears could form when driving with summer tires, causing permanent damage to the tires.

- ▶ At temperatures below 45 °F (7 °C) use  M+S tires.

Accessory parts which are not approved for your vehicle by Mercedes-Benz, or which are not used correctly, can impair the operating safety.

Before purchasing and using non-approved accessories, visit a qualified specialist workshop and inquire about:

- Suitability
- Legal stipulations
- Factory recommendations

**!** **WARNING** Risk of accident with high performance tires

The special tire tread in combination with the optimized tire compound means that the risk of skidding and hydroplaning on wet roads is increased.

In addition, the tire grip is greatly reduced at a low outside temperature and tire running temperature.

- ▶ Switch on the ESP® and adapt your driving style accordingly.
- ▶ Use  M+S tires at outside temperatures of less than 50 °F (10 °C).
- ▶ Only use the tires for their intended purpose.

Observe the following when selecting, installing and replacing tires:

- Furthermore, the use of certain tire types in certain regions and areas of operation can be highly beneficial.
- Only use tires and wheels of the same type (summer tires, winter tires, MOExtended tires) and the same make.
- Only install wheels of the same size on one axle (left and right).

It is only permissible to install a different wheel size in the event of a flat tire in order to drive to the specialist workshop.

- **Vehicles with a tire pressure monitoring system:** All installed wheels must be equipped with functioning sensors for the tire pressure monitoring system.
- At temperatures below 45 °F (7 °C) use winter tires or all-season tires marked  M+S for all wheels.

Winter tires provide the best possible grip in wintry road conditions.

- For M+S tires, only use tires with the same tread.
- Observe the maximum permissible speed for the M+S tires installed.  
If the tire's maximum speed is below that of the vehicle, this must be indicated by an appropriate label in the driver's field of vision.
- Break in new tires at moderate speeds for the first 60 miles (100 km).
- Replace the tires after six years at the latest, regardless of wear.
- **When replacing with tires that do not feature run-flat characteristics:** vehicles with MOExtended tires are not equipped with a TIREFIT kit at the factory. Equip the vehicle with a TIREFIT kit after replacing with tires that do not feature run-flat characteristics, e.g. winter tires.

For more information on wheels and tires, contact a qualified specialist workshop.

Be sure to also observe the following further related subjects:

- Notes on tire pressure (→ page 302)

- Tire and Loading Information placard (→ page 308)
- Tire size designation, load-bearing capacity, speed rating and load index (→ page 316)
- Tire pressure table (→ page 304)
- Notes on the emergency spare wheel (→ page 330)

#### Notes on rotating the wheels

 **WARNING** Risk of injury through different wheel sizes

Rotating the front and rear wheels can severely impair the driving characteristics. The wheel brakes or suspension components may also be damaged.

 Rotate front and rear wheels only if the wheels and tires are of the same dimensions.

The wear patterns on the front and rear wheels differ:

- Front wheels wear more on the tire shoulder

- Rear wheels wear more in the center of the tire

Do not drive with tires that have too little tread depth. This significantly reduces traction on wet roads (hydroplaning).

On vehicles that have the same size front and rear wheels, rotate the wheels according to the intervals in the tire manufacturer's warranty book in your vehicle documents. If this is not available, rotate the tires every 3,000 to 6,000 miles (5,000 to 10,000 km), depending on the wear. Ensure that the direction of rotation is maintained.

Observe the instructions and safety notes on "Changing a wheel" when doing so (→ page 324).

### Notes on storing wheels

When storing wheels, observe the following notes:

- After removing wheels, store them in a cool, dry and preferably dark place.
- Protect the tires from contact with oil, grease or fuel.

### Overview of the tire-change tool kit

#### ! NOTE Mercedes-AMG vehicles

- ▶ Observe the notes in the Supplement. You could otherwise fail to recognize dangers.

Apart from some country-specific variants, vehicles are not equipped with a tire-change tool kit. For more information on which tire-changing tools are required and approved for performing a wheel change on your vehicle, consult a qualified specialist workshop.

You require the following tools, for example, to change a wheel:

- Jack
- Chock
- Lug wrench
- Alignment bolt

The tire-change tool kit is located under the trunk floor.

- i Depending on the model, the tire change tool kit may be located at other positions under the trunk floor.

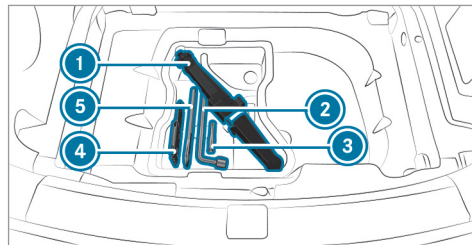

- ① Jack
- ② Lug wrench
- ③ Alignment bolt
- ④ Folding chock
- ⑤ Ratchet for jack

### Preparing the vehicle for a wheel change

#### Requirements:

- The vehicle is not on a slope.



- The vehicle is on solid, non-slippery and level ground.
- The required tire-change tool kit is available.

**i** If your vehicle is not equipped with the tire-change tool kit, consult a qualified specialist workshop to find out about suitable tools.

- ▶ Apply the electric parking brake manually.
- ▶ Move the front wheels to the straight-ahead position.
- ▶ Shift the transmission to position **P**.
- ▶ **Vehicles with level control system:** Set the normal vehicle level (→ page 197).
- ▶ Switch off the vehicle.
- ▶ Make sure that the vehicle cannot be started.
- ▶ Place chocks or other suitable items under the front and rear of the wheel that is diagonally opposite the wheel you wish to change.
- ▶ If necessary, remove the wheel trim/hub caps (→ page 325).
- ▶ Raise the vehicle (→ page 326).

### Removing and installing the wheel trim/hub caps

#### Requirements:

- The vehicle is prepared for a wheel change (→ page 324).

#### Plastic hub cap

- ▶ **To remove:** turn the center cover of the hub cap counter-clockwise and remove the hub cap.
- ▶ **To install:** make sure that the center cover of the hub cap is turned counter-clockwise.
- ▶ Position the hub cap and turn the center cover clockwise until the hub cap engages physically and audibly.

#### Aluminum hub cap

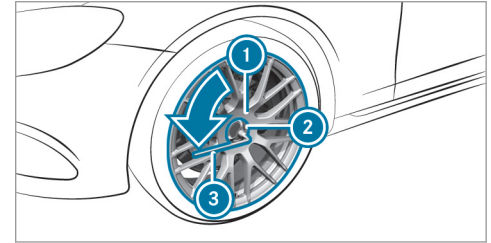

- ▶ **To remove:** position socket **2** from the tire-change tool kit on hub cap **1**.
  - ▶ Position wheel wrench **3** on socket **2**.
  - ▶ Using wheel wrench **3**, turn hub cap **1** counter-clockwise and remove it.
  - ▶ **To install:** follow the instructions above in reverse order.
- i** **Specified tightening torque:** 18 lb-ft (25 Nm).

### Raising the vehicle when changing a wheel

#### Requirements:

- There are no persons in the vehicle.
- The vehicle has been prepared for a wheel change (→ page 324).
- The wheel trims and hub caps have been removed (→ page 325).

#### Important notes on using the jack:

- Use only a vehicle-specific jack that has been approved by Mercedes-Benz to raise the vehicle.
- The jack is only designed for raising and holding the vehicle for a short time while a wheel is being changed and not for maintenance work under the vehicle.
- The jack must be placed on a firm, flat and non-slip surface. If necessary, use a large, flat, load-bearing, non-slip underlay.
- The foot of the jack must be positioned vertically under the jack support point.

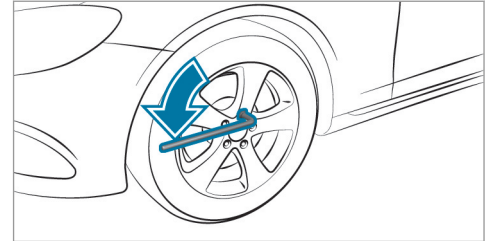
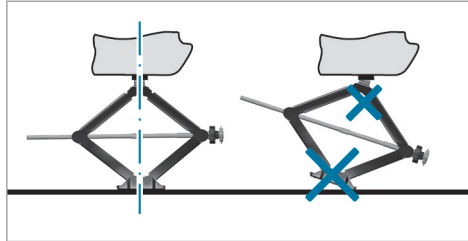

#### Rules of conduct when the vehicle is raised:

- Never place your hands or feet under the vehicle.
- Never lie under the vehicle.
- Do not start the vehicle and do not release the electric parking brake.
- Do not open or close any doors or the trunk lid.

- ▶ Using the lug wrench, loosen the wheel bolts on the wheel you wish to change by about one full turn. Do not unscrew the screws completely.

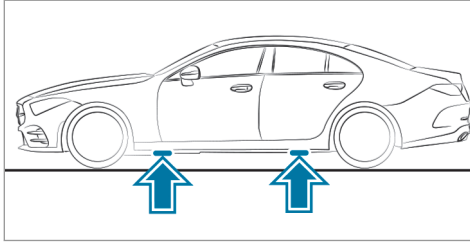

Position of jack support points

**!** **NOTE** Mercedes-AMG vehicles

- ▶ Observe the notes in the Supplement. You could otherwise fail to recognize dangers.

**!** **WARNING** Risk of injury from incorrect positioning of the jack

If you do not position the jack correctly at the appropriate jacking point of the vehicle, the jack could tip with the vehicle raised.

- ▶ Only position the jack at the appropriate jacking point of the vehicle. The base of

the jack must be positioned vertically under the jacking point of the vehicle.

**!** **NOTE** Vehicle damage from the jack

If you do not position the jack correctly at the appropriate jack support point of the vehicle, the jack could tip over with the vehicle raised.

- ▶ The jack is designed exclusively for jacking up the vehicle at the jack support points.

- ▶ Take the ratchet out of the tire-change tool kit and place it on the hexagon nut of the jack so that the letters "AUF" are visible.

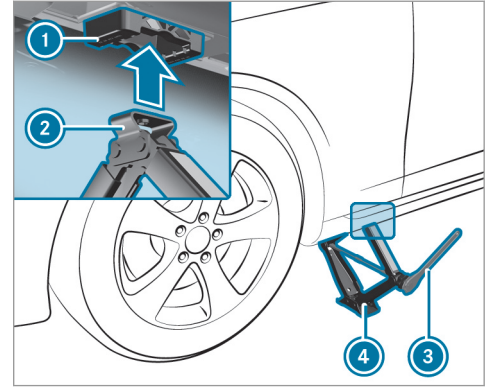

- ▶ Position support **2** of jack **4** on jack support point **1**.
- ▶ Turn ratchet **3** clockwise until support **2** sits completely on jack support point **1** and the base of the jack lies evenly on the ground.
- ▶ Turn ratchet **3** until the tire is raised a maximum of 1.2 in (3 cm) from the ground.
- ▶ Loosen and remove the wheel (→ page 328).

## Removing a wheel

### Requirements:

- The vehicle is raised (→ page 326).

#### **!** NOTE Mercedes-AMG vehicles

- ▶ Observe the notes in the Supplement. You could otherwise fail to recognize dangers.

When changing a wheel, avoid applying any force to the brake discs, as this could impair the level of comfort when braking.

#### **!** NOTE Damage to threading from dirt on wheel bolts

- ▶ Do not place wheel bolts in sand or on a dirty surface.

- ▶ Unscrew the uppermost wheel bolt completely.

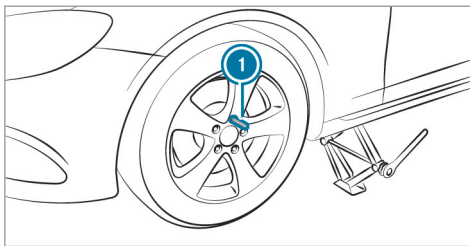

- ▶ Screw alignment bolt ① into the thread instead of the wheel bolt.
- ▶ Unscrew the remaining wheel bolts completely.
- ▶ Remove the wheel.

## Installing a new wheel

#### **!** NOTE Mercedes-AMG vehicles

- ▶ Observe the notes in the Supplement. You could otherwise fail to recognize dangers.

#### **!** WARNING Risk of accident from losing a wheel

Oiled, greased or damaged wheel bolt/wheel nut threads or wheel hub/wheel mounting bolt threads can cause the wheel bolts/wheel nuts to come loose.

- ▶ Never oil or grease the threads.
- ▶ In the event of damage to the threads, contact a qualified specialist workshop immediately.
- ▶ Have the damaged wheel bolts or damaged hub threads replaced.
- ▶ Do not continue driving.

- ▶ Observe the information on the choice of tires (→ page 320).

For tires with a specified direction of rotation, an arrow on the side wall of the tire indicates the correct direction of rotation. Observe the direction of rotation when installing.

- ▶ Slide the wheel to be mounted onto the alignment bolt and push it on.

**⚠ WARNING** Risk of injury from tightening wheel bolts and nuts

If you tighten the wheel bolts or wheel nuts when the vehicle is raised, the jack could tip.

- ▶ Only tighten wheel bolts or wheel nuts when the vehicle is on the ground.

- ▶ Be sure to observe the instructions and safety notes on "Changing a wheel" (→ page 320).
- ▶ For safety reasons, only use wheel bolts which have been approved by Mercedes-Benz and for the wheel in question.

**! NOTE** Damage to paintwork of the wheel rim when screwing in the first wheel bolt

If the wheel has too much play when screwing in the first wheel bolt, the wheel rim paint can be damaged.

- ▶ Press the wheel firmly against the wheel hub when screwing in the first wheel bolt.

- ▶ Tighten the wheel bolts evenly in a diagonal pattern in the order indicated until they are finger-tight.
- ▶ Unscrew and remove the alignment bolt.
- ▶ Tighten the last wheel bolt until it is finger-tight.
- ▶ Lower the vehicle (→ page 329).

### Lowering the vehicle after a wheel change

**Requirements:**

- The new wheel has been installed (→ page 328).
- ▶ **To lower the vehicle:** place the ratchet onto the hexagon nut of the jack so that the letters "AB" are visible and turn counter-clockwise.

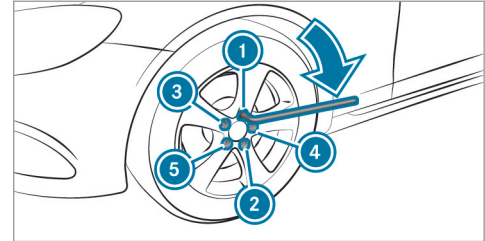

- ▶ Tighten the wheel bolts evenly in a diagonal pattern in the order indicated ① to ⑤ with an initial maximum force of 59 lb-ft (80 Nm).
- ▶ Tighten the wheel bolts evenly in a diagonal pattern in the order indicated ① to ⑤ with the specified tightening torque of 111 lb-ft (150 Nm).

**⚠ WARNING** Risk of accident due to incorrect tightening torque

The wheels could come loose if the wheel bolts or wheel nuts are not tightened to the prescribed torque.

- ▶ Ensure that the wheel bolts or wheel nuts are tightened to the prescribed tightening torque.
- ▶ If you are not sure, do not move the vehicle. Contact a qualified specialist workshop and have the tightening torque checked immediately.

▶ Check the tire pressure of the newly installed wheel and adjust it if necessary.

ⓘ The following does not apply if the new wheel is an emergency spare wheel.

▶ **Vehicles with tire pressure loss warning system:** Restart the tire pressure loss warning system (→ page 308).

▶ **Vehicles with a tire pressure monitoring system:** Restart the tire pressure monitoring system (→ page 307).

## Emergency spare wheel

### Notes on the emergency spare wheel

**⚠ WARNING** Risk of accident caused by incorrect wheel and tire dimensions

The wheel or tire sizes and the tire type of the emergency spare wheel or spare wheel and the wheel to be replaced may differ. The emergency spare wheel or spare wheel can significantly impair driving characteristics of the vehicle.

To prevent hazardous situations:

- ▶ Drive carefully.
- ▶ Never install more than one emergency spare wheel or spare wheel that differs in size.
- ▶ Only use an emergency spare wheel or spare wheel briefly.
- ▶ Do not deactivate ESP®.
- ▶ Have the emergency spare wheel or spare wheel of a different size replaced at the nearest qualified specialist work-

shop. The new wheel must have the correct dimensions.

ⓘ The emergency spare wheel is secured in the emergency spare wheel bag in the trunk.

Observe the following notes on installing an emergency spare wheel:

- The maximum permissible speed with an emergency spare wheel installed is 50 mph (80 km/h).
  - Do not equip the emergency spare wheel with snow chains.
  - Replace the emergency spare wheel after six years at the latest, regardless of wear.
  - Check the tire pressure of the emergency spare wheel installed. Correct the pressure as necessary.
- ⓘ The specified tire pressure is stated on the label of the emergency spare wheel.

- i Vehicles with a tire pressure loss warning system:** If an emergency spare wheel is installed, the tire pressure loss warning system cannot function reliably. Only restart the system again when the emergency spare wheel has been replaced with a new wheel.
- Vehicles with a tire pressure monitoring system:** If an emergency spare wheel is installed, the tire pressure monitoring system cannot function reliably. For a few minutes after an emergency spare wheel is installed, the system may still display the tire pressure of the removed wheel. Only restart the system again when the emergency spare wheel has been replaced with a new wheel.

Be sure to also observe the following further related subjects:

- Notes on tire pressure (→ page 302)
- Tire and Loading Information placard (→ page 308)
- Tire pressure table (→ page 304)
- Notes on installing tires (→ page 320)
- Installing an emergency spare wheel (→ page 324)

### Notes on technical data

#### **!** NOTE Mercedes-AMG vehicles

- ▶ Observe the notes in the Supplement. You could otherwise fail to recognize dangers.

The data stated only applies to vehicles with standard equipment. You can obtain further information from an authorized Mercedes-Benz Center.

### Vehicle electronics

#### Two-way radios

##### Notes on installing two-way radios

#### **!** WARNING Risk of accident due to improper work on two-way radios

If two-way radios are manipulated or retrofitted incorrectly, the electromagnetic radiation from the two-way radios can interfere with the vehicle electronics and jeopardize the operating safety of the vehicle.

- ▶ You should have all work on electrical and electronic components carried out at a qualified specialist workshop.

#### **!** WARNING Risk of accident due to improper operation of two-way radios

If you use two-way radios in the vehicle improperly, their electromagnetic radiation can disrupt the vehicle's electronics. This is the case in the following situations, in particular:

- The two-way radio is not connected to an exterior antenna.
- The exterior antenna is installed incorrectly or is not a low-reflection antenna.

This could jeopardize the operating safety of the vehicle.

- ▶ Have the low-reflection exterior antenna installed at a qualified specialist workshop.

- ▶ When operating two-way radios in the vehicle, always connect them to the low-reflection exterior antenna.

#### **!** NOTE Invalidation of the operating permit due to failure to comply with the instructions for installation and use

The operating permit may be invalidated if the instructions for installation and use of two-way radios are not observed.

- ▶ Only use approved frequency bands.
- ▶ Observe the maximum permissible output power in these frequency bands.
- ▶ Only use approved antenna positions.



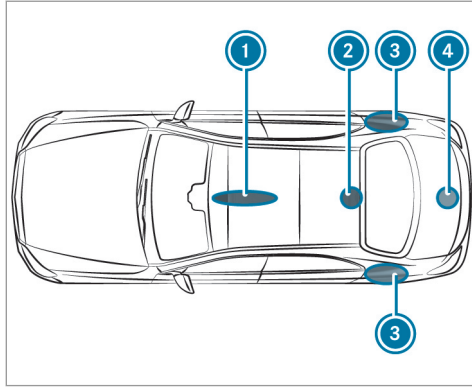

- ① Front roof area
- ② Rear roof area
- ③ Rear fenders
- ④ Trunk lid

On the rear fenders, it is recommended that you install the antenna on the side of the vehicle closest to the center of the road.

Use Technical Specification ISO/TS 21609 (Road Vehicles – "EMCs for installation of aftermarket radio frequency transmitting equipment") when retrofitting two-way radios. Comply with the legal requirements for detachable parts.

If your vehicle has installations for two-way radio equipment, use the power supply and antenna connectors provided in the pre-installation. Observe the manufacturer's supplements when installing.

#### Two-way radio transmission output

The maximum transmission output (PEAK) at the base of the antenna must not exceed the values in the following table.

#### Frequency band and maximum transmission output

Frequency band	Maximum transmission output
Short wave 3 - 54 MHz	100 W
4 m frequency band 74 - 88 MHz	30 W
2 m frequency band 144 - 174 MHz	50 W
Terrestrial Trunked Radio (TETRA) 380 - 460 MHz	10 W
70 cm frequency band 420 - 450 MHz	35 W
Two-way radio (2G/3G/4G)	10 W

The following can be used in the vehicle without restrictions:

- Two-way radios with a maximum transmission output of up to 100 mW
- RF transmitters with transmitter frequencies in the 380 - 410 MHz frequency band and a maximum transmission output of up to 2 W (TETRA)
- Mobile phones (2G/3G/4G)

There are no restrictions when positioning the antenna on the outside of the vehicle for the following frequency bands:

- Terrestrial Trunked Radio (TETRA)
- 70 cm frequency band
- 2G/3G/4G

### Regulatory radio identification and notes

#### Regulatory radio identification of small components

Manufacturer information about radio-based vehicle components can be found using the key phrase "Regulatory radio identification" in the Dig-

ital Operator's Manual in the vehicle, on the Internet and in the app.

#### Regulatory radio identification – Indonesia

Manufacturer information about radio-based vehicle components can be found using the key phrase "Regulatory radio identification – Indonesia" in the Digital Operator's Manual in the vehicle, on the Internet and in the app.

- ① These are not small components. Information about small components can be found using the key phrase "Regulatory radio identification of small components".

#### Information on user separation distances

Information on user separation distances of wireless vehicle components can be found using the key phrase "User separation distances" in the Digital Operator's Manual in the vehicle, on the Internet, and in the app.

#### Further component-specific information

Further component-specific information can be found using the key phrase "further component-specific information" in the Digital Operator's Manual in the vehicle, on the Internet and in the app.

Vehicle identification plate, VIN and engine number overview

Vehicle identification plate

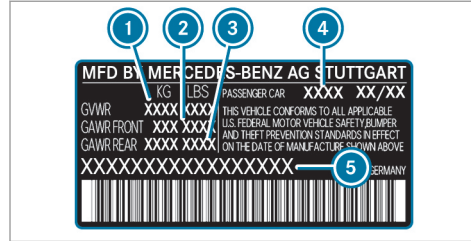
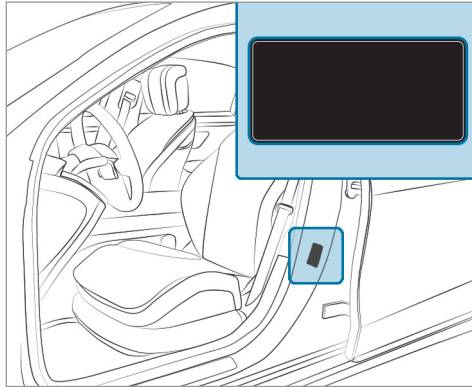

Vehicle identification plate (USA only)

- ① Maximum permissible gross vehicle weight
- ② Maximum permissible front axle load
- ③ Maximum permissible rear axle load
- ④ Paint code
- ⑤ VIN (vehicle identification number)

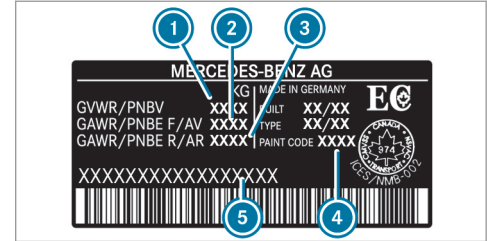

Vehicle identification plate (Canada only)

- ① Maximum permissible gross vehicle weight
- ② Maximum permissible front axle load
- ③ Maximum permissible rear axle load
- ④ Paint code
- ⑤ VIN (vehicle identification number)

The maximum permissible gross vehicle weight is made up of the vehicle weight, all vehicle occupants, the fuel and the load. The maximum gross axle weight rating is the maximum weight that can be carried on one axle (front or rear axle).





**ENVIRONMENTAL NOTE** Pollution of the environment due to irresponsible disposal of operating fluids

Incorrect disposal of operating fluids can cause considerable damage to the environment.

- ▶ Dispose of operating fluids in an environmentally responsible manner.

Operating fluids include the following:

- Fuels
- Lubricants
- Coolant
- Brake fluid
- Windshield washer fluid
- Climate control system refrigerant

Only use products approved by Mercedes-Benz. Damage caused by the use of products that have not been approved is not covered by the Mercedes-Benz warranty or goodwill gestures.

The operating fluids approved by Mercedes-Benz can be identified by the following inscriptions on the container:

- MB-Freigabe (e.g. MB-Freigabe 229.51)
- MB-Approval (e.g. MB-Approval 229.51)

Further information on approved operating fluids:

- In the Mercedes-Benz Specifications for Operating Fluids by entering the designation
  - At <https://bevo.mercedes-benz.com>
  - In the Mercedes-Benz BeVo app
- At a qualified specialist workshop

**⚠ WARNING** Risk of fire or explosion from fuel

Fuels are highly flammable.

- ▶ Fire, open flames, smoking and creating sparks must be avoided.
- ▶ Before and during refueling, switch off the vehicle and, if installed, the stationary heater.

**⚠ WARNING** Risk of injury from fuels

Fuels are poisonous and hazardous to your health.

- ▶ Do not swallow fuel or let it come into contact with skin, eyes or clothing.
- ▶ Do not inhale fuel vapor.
- ▶ Keep children away from fuel.
- ▶ Keep doors and windows closed during the refueling process.

If you or other people come into contact with fuel, observe the following:

- ▶ Immediately rinse fuel off your skin with soap and water.
- ▶ If fuel comes into contact with your eyes, immediately rinse them thoroughly with clean water. Seek medical attention immediately.
- ▶ If you swallow fuel, seek medical attention immediately. Do not induce vomiting.

- ▶ Change immediately out of clothing that has come into contact with fuel.

Flexible-fuel vehicles can be refueled with the following fuel types:

- Unleaded premium grade gasoline
- E85 fuel
- A mixture of E85 fuel and unleaded premium grade gasoline

Flexible-fuel vehicles can be identified by the **Ethanol up to E85** sticker on the inside of the fuel filler flap.

Depending on the country, the fuels you can use in your vehicle may differ from the information in the Operator's Manual. The fuels that have been approved for your vehicle can be found on the instruction label on the inside of the fuel filler flap.

## Fuel

### Notes on fuel grades for vehicles with a gasoline engine

Observe the notes on operating fluids (→ page 336).

### ! NOTE Damage caused by the wrong fuel

Even small amounts of the wrong fuel could result in damage to the fuel system, the engine and the emission control system.

- ▶ Only refuel with low-sulfur gasoline.

This fuel may contain up to 10% ethanol by volume. Your vehicle is suitable for use with E10 fuel.

Never refuel with one of the following fuels:

- Diesel
- Gasoline with more than 10% ethanol by volume, e.g. E15, E85, E100
- Gasoline with more than 3% methanol by volume, e.g. M15, M30, M85, M100
- Gasoline with additives containing metal

If you have accidentally refueled with the wrong fuel:

- ▶ do not switch the ignition on.
- ▶ Consult a qualified specialist workshop.

If the available fuel is not sufficiently low in sulfur, this can produce unpleasant odors.

Only refuel with fuel that has at least the octane number specified in the information label in the fuel filler flap (→ page 153).

**If you want maximum engine output:** only refuel with unleaded premium grade gasoline with an octane number of at least 91 AKI/95 RON.

As a temporary measure, if the recommended fuel is not available, you may also refuel with unleaded regular gasoline with at least 87 AKI/91 RON. This may reduce engine output and increase fuel consumption.

Never refuel using gasoline with an even lower RON.

### ! NOTE Premature engine wear through unleaded regular gasoline

Impairment of the longevity and performance of the engine.

If unleaded premium grade gasoline is unavailable and you have to refuel using unleaded regular gasoline:

- ▶ Only fill the fuel tank to half full with unleaded regular gasoline and refill as soon as possible with unleaded premium grade gasoline.
- ▶ Do not drive at the maximum design speed.
- ▶ Avoid sudden acceleration and engine speeds over 3000 rpm.

Further information on fuel is available at the following locations:

- At a gas station
- At a qualified specialist workshop
- On the <https://www.mbusa.com> (USA only)

#### Notes on additives in gasoline

Observe the notes on operating fluids (→ page 336).

- !** **NOTE** Damage from use of unsuitable additives

Even small amounts of the wrong additive may lead to malfunctions occurring.

- ▶ Only add cleaning additives recommended by Mercedes-Benz to the fuel.

Mercedes-Benz recommends that you use brand-name fuels with additives.

In some countries, the fuel available may not have sufficient additives. Residue could build up in the fuel injection system as a result. In this case, in consultation with an authorized Mercedes-Benz Center, mix the fuel with the cleaning additive recommended by Mercedes-Benz. Observe the notes and mixing ratios indicated on the tank.

#### Tank content and reserve fuel

##### Total capacity and reserve fuel tank

Model	Total capacity
All models	21.1 gal (80.0 liters)
Model	Of which reserve
All models	3.2 gal (12.0 liters)

## Engine oil

### Notes on engine oil

Observe the notes on operating fluids (→ page 336).



- !** **NOTE** Engine damage caused by an incorrect oil filter, incorrect oil or additives

- ▶ Do not use engine oils or oil filters other than those which meet the specifications necessary for the prescribed service intervals.

- ▶ Do not alter the engine oil or oil filter in order to achieve longer change intervals than prescribed.
- ▶ Do not use additives.
- ▶ Have the engine oil changed after the prescribed intervals.

Mercedes-Benz recommends having the oil changed at a qualified specialist workshop. Only use engine oils approved for your vehicle by Mercedes-Benz.

### Quality and capacity of engine oil

#### Engine oil specifications

Gasoline engines	MB-Freigabe or MB-Approval
CLS 450 4MATIC	229.51, 229.52, 229.61, 229.71 229.72*
All other models	229.51, 229.52, 229.61 229.71*

\* Recommended for lowest possible fuel consumption (lowest SAE viscosity class in each case; observe possible restrictions of the approved SAE viscosity classes).

To achieve the lowest possible fuel consumption, it is recommended to use the engine oil specifications marked in the table for the lowest SAE viscosity class. Possible restrictions of the approved SAE viscosity classes must be observed.

The following values refer to an oil change, including the oil filter.

#### Engine oil filling capacity

Model	Capacity
CLS 450	10.0 US qt (9.5 liters)
CLS 450 4MATIC	9.0 US qt (8.5 liters)

#### Notes on brake fluid

Observe the notes on operating fluids (→ page 336).

**⚠ WARNING** Risk of an accident due to vapor pockets forming in the brake system

The brake fluid constantly absorbs moisture from the air. This lowers the boiling point of the brake fluid. If the boiling point is too low, vapor pockets may form in the brake system when the brakes are applied hard.

This causes the braking effect to be impaired.

- ▶ Have the brake fluid renewed at the specified intervals.

Have the brake fluid regularly replaced at a qualified specialist workshop.

Only use a brake fluid approved by Mercedes-Benz according to MB-Freigabe or MB-Approval 331.0.

#### Coolant

##### Notes on coolant

Observe the notes on operating fluids (→ page 336).



**⚠ WARNING** - Risk of fire and injury from antifreeze

If antifreeze comes into contact with hot component parts in the engine compartment, it may ignite.

- ▶ Allow the engine to cool down before adding antifreeze.
- ▶ Make sure that no antifreeze spills out next to the filler opening.
- ▶ Thoroughly clean off any antifreeze from component parts before starting the vehicle.

**! NOTE** Damage caused by incorrect coolant

- ▶ Only use coolant that has been premixed with the required antifreeze protection.

Information on coolant is available at the following locations:

- In the Mercedes-Benz Specification for Operating Fluids 320.1

- At <https://bevo.mercedes-benz.com>
- In the Mercedes-Benz BeVo app
- At a qualified specialist workshop

**! NOTE** Overheating at high outside temperatures

If an inappropriate coolant is used, the engine cooling system is not sufficiently protected against overheating and corrosion at high outside temperatures.

- ▶ Only use coolant approved by Mercedes-Benz.
- ▶ Observe the instructions in the Mercedes-Benz Specifications for Operating Fluids 320.1.

Have the coolant regularly replaced at a qualified specialist workshop.

Proportion of antifreeze concentrate in the engine cooling system:

- A minimum of 50% (antifreeze protection down to about -35°F (-37°C))

- A maximum of 55% (antifreeze protection down to -49°F (-45°C))

**Coolant capacity**

**Coolant (engine)**

Model	Capacity
All models	13.7 US qt (13.0 liters)

**Notes on windshield washer fluid**

Observe the notes on operating fluids (→ page 336).

**⚠ WARNING** - Risk of fire and injury from windshield washer concentrate

Windshield washer concentrate is highly flammable. It could ignite if it comes into contact with hot engine component parts or the exhaust system.

- ▶ Make sure that no windshield washer concentrate spills out next to the filler opening.

**!** **NOTE** Damage to the exterior lighting due to unsuitable windshield washer fluid

Unsuitable windshield washer fluid may damage the plastic surface of the exterior lighting.

- ▶ Only use windshield washer fluid which is also suitable for use on plastic surfaces, e.g. MB SummerFit or MB WinterFit.

**!** **NOTE** Blocked spray nozzles caused by mixing windshield washer fluids

- ▶ Do not mix MB SummerFit and MB WinterFit with other windshield washer fluids.

Do not use distilled or de-ionized water. Otherwise, the fill level sensor may be triggered erroneously.

Recommended windshield washer fluid:

- Above freezing point: e.g. MB SummerFit
- Below freezing point: e.g. MB WinterFit

For the correct mixing ratio, refer to the information on the antifreeze container.

Mix washer fluid with windshield washer fluid all year round.

## Refrigerant

### Notes on refrigerant

Observe the notes on operating fluids (→ page 336).

**!** **NOTE** Damage due to incorrect refrigerant

If a non-approved refrigerant is used, the climate control system may be damaged.

- ▶ **USA:** use only R-134a refrigerant.
- ▶ **Canada:** use only R-1234yf refrigerant.

**!** **NOTE** Damage to the climate control system due to incorrect refrigerant compressor oil

- ▶ Only use refrigerant compressor oil that has been approved by Mercedes-Benz.
- ▶ Do not mix the approved refrigerant compressor oil with a different refrigerant compressor oil.

Work on the climate control system may be carried out only by a qualified specialist workshop. All applicable regulations, as well as SAE standard J639, must be adhered to.

The information label for the climate control system regarding the refrigerant type and the refrigerant compressor oil (PAG oil) is located on the inside of the hood.

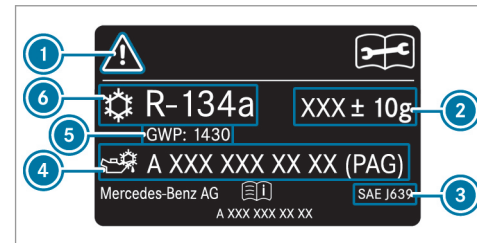

Information label (example – USA/China)

- ① Hazard and service warning symbols
- ② Refrigerant filling capacity
- ③ Applicable standards
- ④ PAG oil part number

- ⑤ GWP (global warming potential) of the refrigerant used
- ⑥ Refrigerant type

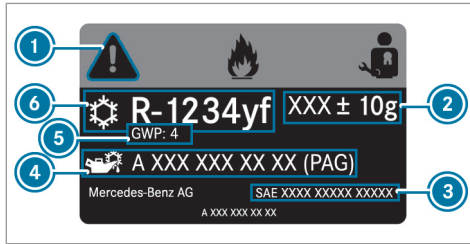

Information label (example - Canada)

- ① Hazard and service warning symbols
- ② Refrigerant filling capacity
- ③ Applicable standards
- ④ PAG oil part number
- ⑤ GWP (global warming potential) of the refrigerant used
- ⑥ Refrigerant type

Symbols ① indicate the following:

- Possible dangers
- The need to have service work carried out at a qualified specialist workshop only

### Filling capacity for refrigerant and PAG oil

#### Capacity

Model	Refrigerant
All models	20.8 ± 0.4 oz (590 ± 10 g)
Model	PAG oil
All models	4.9 ± 0.4 oz (140 ± 10 g)

#### Vehicle data

#### Vehicle dimensions

The heights specified may vary as a result of the following factors:

- Tires
- Load

- Condition of the suspension
- Optional equipment

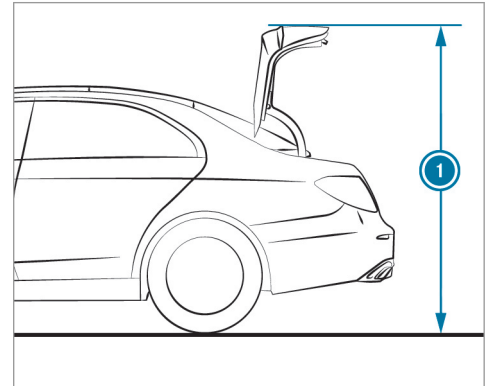

Missing values were not available at the time of going to press.

**Height when opened**

Model	 Height when opened
All models	

**Vehicle dimensions**

All models	
Vehicle length	198.8 in (5050 mm)
Vehicle width including outside mirrors	81.5 in (2069 mm)
Wheelbase	115.7 in (2939 mm)

**Vehicle height**

Model	Vehicle height
CLS 450	56.4 in (1432 mm)
CLS 450 4MATIC	56.6 in (1438 mm)

**Turning radius**

Model	Turning radius
CLS 450	38.1 ft (11.6 m)
CLS 450 4MATIC	39.0 ft (11.9 m)

**Weights and loads**

Please observe the following notes for the specified vehicle data:

- Items of optional equipment increase the curb weight and reduce the payload.

**Roof load**

Model	Maximum roof load
All models	220.5 lb (100 kg)

## Display messages

### Introduction



#### Notes about display messages

Display messages appear on the instrument display.

Display messages with graphic symbols are simplified in the Operator's Manual and may differ from the symbols on the instrument display. The instrument display shows high-priority display messages in red. Certain display messages are accompanied by a warning tone.

Please act in accordance with the display messages and follow the additional notes in the Operator's Manual.

For some display messages, symbols will also be shown:

-  Further information
-  Hide display message

With the left-hand Touch Control, you can select the respective symbol by swiping to the left or right. Pressing  displays further information on

the media display. Press the  symbol to hide the display message.

You can hide low-priority display messages by pressing the back button  or the left-hand Touch Control. The display messages will then be stored in the message memory.

Rectify the cause of a display message as quickly as possible.

High-priority display messages cannot be hidden. The instrument display will show these display messages permanently until the cause of the display message has been rectified.



#### Calling up saved display messages

On-board computer:



 **Service**  **1 Message**

If there are no display messages, **No Messages** will appear on the instrument display.

 Scroll through the display messages by swiping upwards or downwards on the left-hand Touch Control.

 **To exit the message memory:** press the back button .

Occupant safety

Display messages	Possible causes/consequences and ► Solutions
 <p>SRS Malfunction Service Required</p>	<p>* The restraint system is malfunctioning (→ page 34).</p> <p><b>▲ WARNING</b> Risk of injury due to malfunctions in the restraint system</p> <p>Components in the restraint system may be activated unintentionally or not deploy as planned in an accident.</p> <p>► Have the restraint system checked and repaired immediately at a qualified specialist workshop.</p>
 <p>Front Left Malfunction Service Required (example)</p>	<p>* The corresponding restraint system is malfunctioning (→ page 34).</p> <p><b>▲ WARNING</b> Risk of injury due to malfunctions in the restraint system</p> <p>Components in the restraint system may be activated unintentionally or not deploy as planned in an accident.</p> <p>► Have the restraint system checked and repaired immediately at a qualified specialist workshop.</p>
 <p>Left Side Curtain Airbag Malfunction Service Required (example)</p>	<p>* The corresponding restraint system is malfunctioning (→ page 34).</p> <p><b>▲ WARNING</b> Risk of injury or fatal injury due to a malfunction in the window curtain airbag</p> <p>The window curtain airbag might be triggered unintentionally or might not be triggered at all in the event of an accident.</p> <p>► Have the window curtain airbag checked and repaired immediately at a qualified specialist workshop.</p>

Display messages	Possible causes/consequences and ► Solutions
<p>Front Passenger Airbag Disabled See Operator's Manual</p>	<p>* The front passenger airbag and the front passenger knee airbag have been disabled even though an adult or a person of adult stature is on the front passenger seat. If additional forces are applied to the seat, the weight the system detects may be too low.</p> <div data-bbox="545 341 1690 549" style="border: 1px solid gray; padding: 5px;"> <p><b>▲ WARNING</b> Risk of injury or fatal injury due to a disabled front passenger airbag</p> <p>If the front passenger airbag is disabled, the front passenger airbag will not be deployed in the event of an accident and cannot perform its intended protective function.</p> <p>A person in the front passenger seat could then, for example, come into contact with the vehicle's interior, especially if the person is sitting too close to the cockpit.</p> <p>► Make sure, both before and during the journey, that the status of the front passenger airbag is correct.</p> </div> <ul style="list-style-type: none"> <li>► Stop the vehicle immediately in accordance with the traffic conditions.</li> <li>► Make sure that no objects are trapped under the front passenger seat.</li> <li>► Check the status of automatic front passenger airbag actuation (→ page 43).</li> <li>► If necessary, consult a qualified specialist workshop immediately.</li> </ul>
<p>Front Passenger Airbag Enabled See Operator's Manual</p>	<p>* The front passenger airbag and the front passenger knee airbag will be enabled while the vehicle is in motion in the following situations:</p> <ul style="list-style-type: none"> <li>• Even when a child, a small adult or an object weighing less than the system weight threshold is located on the front passenger seat</li> <li>• Even when the front passenger seat is not occupied</li> </ul>

Display messages	Possible causes/consequences and ► Solutions
	<p>The system may detect objects or forces that are adding to the weight applied to the seat.</p> <p><b>▲ WARNING</b> Risk of injury or death when using a child restraint system while the front passenger airbag is enabled</p> <p>If you secure a child in a child restraint system on the front passenger seat and the front passenger airbag is enabled, the front passenger airbag can deploy in the event of an accident. The child could be struck by the airbag.</p> <p>► Ensure, both before and during the journey, that the status of the front passenger airbag is correct.</p> <p>NEVER use a rearward facing child restraint on a seat protected by an ACTIVE AIRBAG in front of it, DEATH or SERIOUS INJURY to the CHILD can occur.</p> <ul style="list-style-type: none"> <li>► Stop the vehicle immediately in accordance with the traffic conditions.</li> <li>► Make sure that no objects are trapped under the front passenger seat.</li> <li>► Check the status of automatic front passenger airbag actuation (→ page 43).</li> <li>► If necessary, consult a qualified specialist workshop immediately.</li> </ul>
<p>PRE-SAFE Inoperative See Operator's Manual</p>	<p>* The PRE-SAFE® functions are malfunctioning.</p> <ul style="list-style-type: none"> <li>► Consult a qualified specialist workshop.</li> </ul>



Display messages	Possible causes/consequences and ► Solutions
<p>PRE-SAFE Impulse Side Inoperative See Operator's Manual</p>	<p>* The PRE-SAFE® Impulse Side system is malfunctioning or inoperative after having already been triggered.</p> <ul style="list-style-type: none"> <li>► Consult a qualified specialist workshop.</li> </ul>

### SmartKey

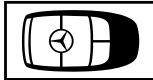
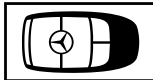

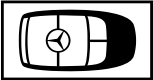
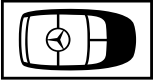
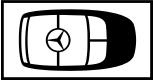

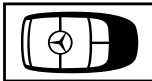
Display messages	Possible causes/consequences and ► Solutions
 <p>Obtain a New Key</p>	<p>* Have the SmartKey replaced.</p> <ul style="list-style-type: none"> <li>► Consult a qualified specialist workshop.</li> </ul>
 <p>Replace Key Battery</p>	<p>* The SmartKey battery is discharged.</p> <ul style="list-style-type: none"> <li>► Replace the battery (→ page 63).</li> </ul>



Display messages	Possible causes/consequences and ► Solutions
 <p data-bbox="144 342 391 394">Key Not Detected (white display message)</p>	<p data-bbox="476 249 864 270">* The SmartKey is currently undetected.</p> <ul data-bbox="495 280 1628 342" style="list-style-type: none"><li data-bbox="495 280 1031 306">► Change the location of the SmartKey in the vehicle.</li><li data-bbox="495 317 1628 342">► If the SmartKey is still not recognized, place it in the marked space for starting with the SmartKey (→ page 136).</li></ul>
 <p data-bbox="144 511 410 563">Key Not Detected (red display message)</p>	<p data-bbox="476 418 1184 439">* The SmartKey cannot be detected and may no longer be in the vehicle.</p> <p data-bbox="495 449 1184 470">The SmartKey is no longer in the vehicle and you switch off the vehicle:</p> <ul data-bbox="495 480 888 542" style="list-style-type: none"><li data-bbox="495 480 870 506">• You can no longer start the vehicle.</li><li data-bbox="495 516 888 542">• You cannot centrally lock the vehicle.</li></ul> <p data-bbox="495 553 944 579">► Ensure that the SmartKey is in the vehicle.</p> <p data-bbox="495 605 1356 625">If the SmartKey detection function has a malfunction due to a strong radio signal source:</p> <ul data-bbox="495 636 1480 698" style="list-style-type: none"><li data-bbox="495 636 1215 662">► Stop the vehicle immediately in accordance with the traffic conditions.</li><li data-bbox="495 672 1480 698">► Place the SmartKey in the marked space for starting the engine with the SmartKey (→ page 136).</li></ul>
 <p data-bbox="144 816 365 842">Don't Forget Your Key</p>	<p data-bbox="476 723 1641 743">* A warning tone will also sound. This message reminds you to take your SmartKey with you when you leave the vehicle.</p>

Display messages	Possible causes/consequences and ► Solutions
 <p data-bbox="194 341 471 393">Key Being Initialized Please Wait</p>	<ul style="list-style-type: none"> <li>* The vehicle is processing in order to teach in the new SmartKey.               <ul style="list-style-type: none"> <li>► Wait until processing is complete.</li> </ul> </li> </ul>
<p data-bbox="194 419 462 492">Place the Key in the Marked Space See Operator's Manual</p>	<ul style="list-style-type: none"> <li>* SmartKey detection is malfunctioning.               <ul style="list-style-type: none"> <li>► Change the location of the SmartKey in the vehicle.</li> <li>► Place the SmartKey in the marked space for starting the engine with the SmartKey (→ page 136).</li> </ul> </li> </ul>

## Lights

Display messages	Possible causes/consequences and ► Solutions
 <p data-bbox="194 745 369 797">Check Left Low Beam (example)</p>	<ul style="list-style-type: none"> <li>* The corresponding light source is defective.               <ul style="list-style-type: none"> <li>► Drive on carefully.</li> <li>► Visit a qualified specialist workshop immediately.</li> </ul> </li> <li>ⓘ LED light sources: the display message for the corresponding light appears only when all the light-emitting diodes in the light are faulty.</li> </ul>



Display messages	Possible causes/consequences and ► Solutions
 <p data-bbox="144 339 388 391">Malfunction See Operator's Manual</p>	<ul style="list-style-type: none"><li>* The exterior lighting is malfunctioning.<ul style="list-style-type: none"><li>► Consult a qualified specialist workshop.</li></ul></li></ul>
 <p data-bbox="144 508 421 560">Automatic Headlamp Mode Inoperative</p>	<ul style="list-style-type: none"><li>* The light sensor for automatic driving lights is malfunctioning.<ul style="list-style-type: none"><li>► Consult a qualified specialist workshop.</li></ul></li></ul>
 <p data-bbox="144 677 421 729">Active Headlamps Inoperative</p>	<ul style="list-style-type: none"><li>* The active headlamps are malfunctioning.<ul style="list-style-type: none"><li>► Consult a qualified specialist workshop.</li></ul></li></ul>
 <p data-bbox="144 846 369 872">Switch On Headlamps</p>	<ul style="list-style-type: none"><li>* You are driving without low-beam headlamps.<ul style="list-style-type: none"><li>► Turn the light switch to the  or <b>AUTO</b> position.</li></ul></li></ul>

Display messages	Possible causes/consequences and ► Solutions
 <p>Switch Off Lights</p>	<ul style="list-style-type: none"> <li>* You are leaving the vehicle and the lights are still switched on.               <ul style="list-style-type: none"> <li>► Turn the light switch to the <b>AUTO</b> position.</li> </ul> </li> </ul>
 <p>Intell. Light System Inoperative</p>	<ul style="list-style-type: none"> <li>* The Intelligent Light System is malfunctioning. The lighting system continues to function properly without the functions of the Intelligent Light System.               <ul style="list-style-type: none"> <li>► Consult a qualified specialist workshop.</li> </ul> </li> </ul>
<p>Adaptive Highbeam Assist Currently Unavailable See Operator's Manual</p>	<ul style="list-style-type: none"> <li>* Adaptive Highbeam Assist is temporarily unavailable. The system limits have been reached (→ page 116). Once the cause of the problem is no longer present, the system will be available again. The <b>Adaptive Highbeam Assist Now Available</b> display message will appear.               <ul style="list-style-type: none"> <li>► Drive on.</li> <li>► Operate the high beam manually until Adaptive High Beam Assist is available again.</li> </ul> </li> </ul>
<p>Adaptive Highbeam Assist Inoperative</p>	<ul style="list-style-type: none"> <li>* Adaptive Highbeam Assist is malfunctioning.               <ul style="list-style-type: none"> <li>► Drive on.</li> </ul>               or             </li> </ul>

Display messages	Possible causes/consequences and ► Solutions
	<ul style="list-style-type: none"> <li>► Stop the vehicle in accordance with the traffic conditions and restart the vehicle.</li> <li>► If the display message does not disappear: consult a qualified specialist workshop.</li> <li>► Until then, operate the high beam manually.</li> </ul>
<p>Adaptive Highbeam Assist Plus Currently Unavailable See Operator's Manual</p>	<p>* Adaptive Highbeam Assist Plus is temporarily unavailable. The system limits have been reached (→ page 117). Once the cause of the problem is no longer present, the system will be available again. The <b>Adaptive Highbeam Assist Plus Available Again</b> display message will appear.</p> <ul style="list-style-type: none"> <li>► Drive on.</li> <li>► Operate the high beam manually until Adaptive High Beam Assist Plus is available again.</li> </ul>
<p>Adaptive Highbeam Assist Plus Inoperative</p>	<p>* Adaptive Highbeam Assist Plus is malfunctioning.</p> <ul style="list-style-type: none"> <li>► Drive on.</li> </ul> <p>or</p> <ul style="list-style-type: none"> <li>► Stop the vehicle in accordance with the traffic conditions and restart the vehicle.</li> <li>► If the display message does not disappear: consult a qualified specialist workshop.</li> <li>► Until then, operate the high beam manually.</li> </ul>
<p>Hazard Warning Flashers Malfunctioning</p>	<p>* The hazard warning lamp switch is malfunctioning.</p> <ul style="list-style-type: none"> <li>► Consult a qualified specialist workshop.</li> </ul>



## Vehicle

Display messages	Possible causes/consequences and ► Solutions
 <p data-bbox="195 381 426 458">Vehicle Ready to Drive Switch the Ignition Off Before Exiting</p>	<p data-bbox="524 288 1045 313">* You are leaving the vehicle in a ready-to-drive state.</p> <ul style="list-style-type: none"> <li data-bbox="543 322 1402 348">► Get out of the vehicle, secure it against rolling away and take the SmartKey with you.</li> <li data-bbox="543 356 1689 410">► If you do not leave the vehicle, switch off the electrical consumers, e.g. the seat heating. Otherwise, the 12-V battery may discharge and starting the engine may be possible only with the help of a second battery (jump start).</li> </ul>
<p data-bbox="195 482 473 557">Head-up Display Currently Unavailable See Operator's Manual</p>	<p data-bbox="524 482 1171 508">* The Head-up Display is temporarily unavailable. Possible causes:</p> <ul style="list-style-type: none"> <li data-bbox="543 519 903 544">• Malfunctions in the power supply</li> <li data-bbox="543 553 765 579">• Signal interference</li> </ul> <ul style="list-style-type: none"> <li data-bbox="543 594 1415 620">► Stop in accordance with the traffic conditions and switch the vehicle off and on again.</li> <li data-bbox="543 628 1313 654">► If the display message still appears, consult a qualified specialist workshop.</li> </ul>
<p data-bbox="195 671 450 717">Head-up Display Inopera- tive</p>	<p data-bbox="524 671 957 697">* The Head-up Display has an internal error.</p> <ul style="list-style-type: none"> <li data-bbox="543 705 964 731">► Consult a qualified specialist workshop.</li> </ul>

Display messages	Possible causes/consequences and ► Solutions
 <p data-bbox="144 342 397 418">Steering Malfunction Increased Physical Effort See Operator's Manual</p>	<p data-bbox="476 249 966 275">* The power steering assistance is malfunctioning.</p> <div data-bbox="500 291 1648 443" style="border: 1px solid black; padding: 5px;"> <p data-bbox="506 301 1221 327">▲ <b>WARNING</b> Risk of an accident due to altered steering characteristics</p> <p data-bbox="513 339 1554 365">If the power assistance of the steering fails partially or completely, you will need to use more force to steer.</p> <ul style="list-style-type: none"> <li data-bbox="513 373 981 399">▶ If safe steering is possible, drive on carefully.</li> <li data-bbox="513 408 1123 434">▶ Visit or consult a qualified specialist workshop immediately.</li> </ul> </div>
 <p data-bbox="144 552 408 627">Steering Malfunction Stop Immediately See Operator's Manual</p>	<p data-bbox="476 458 1217 484">* The steering is malfunctioning. Steering capability is significantly impaired.</p> <div data-bbox="500 500 1648 676" style="border: 1px solid black; padding: 5px;"> <p data-bbox="506 510 1129 536">▲ <b>WARNING</b> Risk of accident if steering capability is impaired</p> <p data-bbox="513 549 1387 574">If the steering does not function as intended, the vehicle's operating safety is jeopardized.</p> <ul style="list-style-type: none"> <li data-bbox="513 583 1591 635">▶ Pull over and stop the vehicle safely as soon as possible, paying attention to road and traffic conditions. Do not continue driving under any circumstances.</li> <li data-bbox="513 643 931 669">▶ Consult a qualified specialist workshop.</li> </ul> </div>
	<p data-bbox="467 695 746 721">* At least one door is open.</p> <ul style="list-style-type: none"> <li data-bbox="495 729 681 755">▶ Close all doors.</li> </ul>

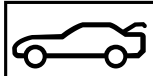





Display messages	Possible causes/consequences and ► Solutions
	<p>* The hood is open.</p> <p><b>▲ WARNING</b> Risk of accident due to driving with the hood unlocked</p> <p>The hood may open and block your view.</p> <ul style="list-style-type: none"><li>▶ Never release the hood when driving.</li><li>▶ Before every trip, ensure that the hood is locked.</li></ul> <p>▶ Stop the vehicle immediately in accordance with the traffic conditions.</p> <p>▶ Close the hood.</p>
	<p>* The trunk lid is open.</p> <p><b>▲ DANGER</b> Risk of exhaust gas poisoning</p> <p>Combustion engines emit poisonous exhaust gases such as carbon monoxide. Exhaust gases can enter the vehicle interior if the trunk lid is open when the vehicle is running, especially if the vehicle is in motion.</p> <ul style="list-style-type: none"><li>▶ Always switch off the vehicle before opening the trunk lid.</li><li>▶ Never drive with the trunk lid open.</li></ul> <p>▶ Close the trunk lid.</p>

Display messages	Possible causes/consequences and ► Solutions
 <p>Rear Left Backrest Not Latched (example)</p>	<ul style="list-style-type: none"><li>* The seat backrest of the corresponding seat is not engaged.<ul style="list-style-type: none"><li>► Fold the seat backrest back until it engages.</li></ul></li></ul>
 <p>Check Washer Fluid</p>	<ul style="list-style-type: none"><li>* The washer fluid level in the washer fluid reservoir has dropped below the minimum.<ul style="list-style-type: none"><li>► Add washer fluid (→ page 273).</li></ul></li></ul>
<p>Wiper Malfunctioning</p>	<ul style="list-style-type: none"><li>* The windshield wipers are malfunctioning.<ul style="list-style-type: none"><li>► Restart the vehicle.</li></ul></li></ul> <p>If the display message still appears:</p> <ul style="list-style-type: none"><li>► Consult a qualified specialist workshop.</li></ul>

## Engine

Display messages	Possible causes/consequences and ► Solutions
To switch engine off, press and hold Start/Stop button for at least 3 seconds or press 3 times.	<ul style="list-style-type: none"> <li>* You have pressed the start/stop button while the vehicle is in motion.               <ul style="list-style-type: none"> <li>► Information about switching off the vehicle while driving (→ page 135).</li> </ul> </li> </ul>
Cannot Start Engine See Operator's Manual	<ul style="list-style-type: none"> <li>* The vehicle cannot be started.               <ul style="list-style-type: none"> <li>► Switch the vehicle off and switch it back on</li> <li>► If the display message still appears, consult a qualified specialist workshop.</li> </ul> </li> </ul>
 <p>Check Coolant Level See Operator's Manual</p>	<ul style="list-style-type: none"> <li>* The coolant level is too low.               <div style="border: 1px solid black; padding: 5px; margin: 10px 0;"> <p><b>!</b> <b>NOTE</b> Engine damage due to insufficient coolant</p> <ul style="list-style-type: none"> <li>► Avoid long journeys with insufficient coolant.</li> </ul> </div> <ul style="list-style-type: none"> <li>► Add coolant (→ page 272).</li> <li>► Have the engine cooling system checked at a qualified specialist workshop.</li> </ul> </li> </ul>

Display messages	Possible causes/consequences and ► Solutions
 <p data-bbox="144 342 421 391">Coolant Too Hot Stop Vehicle Turn Engine Off</p>	<p data-bbox="476 252 717 273">* The coolant is too hot.</p> <ul style="list-style-type: none"> <li data-bbox="495 283 1356 304">► Stop immediately in accordance with the traffic conditions and switch off the vehicle.</li> </ul> <div data-bbox="495 335 1646 588" style="border: 1px solid gray; padding: 5px;"> <p data-bbox="506 346 1023 366"><b>⚠ WARNING</b> Risk of burns when opening the hood</p> <p data-bbox="506 387 1604 428">If you open the hood in the event of an overheated engine or fire in the engine compartment, the following situations may occur:</p> <ul style="list-style-type: none"> <li data-bbox="524 449 968 470">• You may come into contact with hot gases.</li> <li data-bbox="524 480 1208 501">• You may come into contact with other escaping hot operating fluids.</li> </ul> <ul style="list-style-type: none"> <li data-bbox="506 522 1097 542">► Before opening the hood, allow the engine to cool down.</li> <li data-bbox="506 553 1474 573">► In the event of a fire in the engine compartment, keep the hood closed and call the fire service.</li> </ul> </div> <ul style="list-style-type: none"> <li data-bbox="495 605 907 625">► Wait until the engine has cooled down.</li> <li data-bbox="495 636 1134 656">► Make sure that the air supply to the radiator is not obstructed.</li> <li data-bbox="495 667 1622 708">► Avoiding high loads on the engine, drive to the nearest qualified specialist workshop. In doing so, ensure that the coolant temperature display remains below the red marking.</li> </ul>
	<p data-bbox="476 746 999 767">* There is a malfunction in the engine cooling system.</p> <ul style="list-style-type: none"> <li data-bbox="495 778 1622 819">► Avoiding high loads on the engine, drive to the nearest qualified specialist workshop. In doing so, ensure that the coolant temperature display remains below the red marking.</li> </ul>

Display messages	Possible causes/consequences and ► Solutions
 <p>Fuel Level Low</p>	<ul style="list-style-type: none"> <li>* The fuel supply has dropped into the reserve range.               <ul style="list-style-type: none"> <li>► Refuel.</li> </ul> </li> </ul>
 <p>Gas Cap Loose</p>	<ul style="list-style-type: none"> <li>* The fuel filler cap is not closed correctly or the fuel system is leaking.               <ul style="list-style-type: none"> <li>► Close the fuel filler cap.</li> <li>► <b>If the fuel filler cap was already properly closed:</b> consult a qualified specialist workshop.</li> </ul> </li> </ul>

### Transmission

Display messages	Possible causes/consequences and ► Solutions
<p>Only Shift to 'P' when Vehicle is Stationary</p>	<ul style="list-style-type: none"> <li>* It is possible to select the park position <b>P</b> only if the vehicle is stationary.               <ul style="list-style-type: none"> <li>► Depress the brake pedal to stop.</li> <li>► Shift the transmission to park position <b>P</b> when the vehicle is stationary.</li> </ul> </li> </ul>
<p>Apply Brake to Shift from 'P'</p>	<ul style="list-style-type: none"> <li>* You have attempted to shift the transmission out of park position <b>P</b> and into another transmission position.               <ul style="list-style-type: none"> <li>► Depress the brake pedal.</li> <li>► Select transmission position <b>D</b>, <b>R</b> or neutral <b>N</b>.</li> </ul> </li> </ul>





Display messages	Possible causes/consequences and ► Solutions
To Deselect P or N, Depress Brake and Start Engine	<p>* You have attempted to shift the transmission out of park position <b>P</b> or neutral <b>N</b> and into another transmission position.</p> <ul style="list-style-type: none"> <li>► Depress the brake pedal.</li> <li>► Start the vehicle.</li> <li>► Change the transmission position.</li> </ul>
Apply Brake to Shift to D or R	<p>* You have attempted to select transmission position <b>D</b> or <b>R</b>.</p> <ul style="list-style-type: none"> <li>► Depress the brake pedal.</li> <li>► Select transmission position <b>D</b> or <b>R</b>.</li> </ul>
Apply Brake to Shift to 'R'	<p>* You have attempted to select transmission position <b>R</b>.</p> <ul style="list-style-type: none"> <li>► Depress the brake pedal.</li> <li>► Select transmission position <b>R</b>.</li> </ul>
Driver's Door Open & Transmission Not in P Risk of Vehicle Rolling Away	<p>* The driver's door is not fully closed and transmission position <b>D</b>, <b>R</b> or neutral <b>N</b> is selected.</p> <p>The vehicle may roll away.</p> <ul style="list-style-type: none"> <li>► Select park position <b>P</b> when switching off the vehicle.</li> </ul>
N Permanently Active Risk of Rolling Away	<p>* Neutral <b>N</b> has been selected while the vehicle is rolling or while you are driving.</p> <ul style="list-style-type: none"> <li>► Depress the brake pedal to stop.</li> <li>► Shift the transmission to park position <b>P</b> while the vehicle is stationary.</li> <li>► To continue driving, select transmission position <b>D</b> or <b>R</b>.</li> </ul>









Display messages	Possible causes/consequences and ► Solutions
Service Required Do Not Shift Gears Visit Dealer	<ul style="list-style-type: none"> <li>* The transmission is malfunctioning. It is no longer possible to change the transmission position.               <ul style="list-style-type: none"> <li>► If transmission position <b>D</b> is selected, consult a qualified specialist workshop and do not change the transmission position.</li> <li>► For all other transmission positions, park the vehicle safely.</li> <li>► Consult a qualified specialist workshop or breakdown service.</li> </ul> </li> </ul>
Reversing Not Possible Service Required	<ul style="list-style-type: none"> <li>* The transmission is malfunctioning. It is not possible to select transmission position <b>R</b>.               <ul style="list-style-type: none"> <li>► Consult a qualified specialist workshop.</li> </ul> </li> </ul>
Transmission Malfunction Stop	<ul style="list-style-type: none"> <li>* The transmission is malfunctioning. The transmission shifts to neutral <b>N</b> automatically.               <ul style="list-style-type: none"> <li>► Stop the vehicle immediately in accordance with the traffic conditions.</li> <li>► Depress the brake pedal.</li> <li>► Engage park position <b>P</b>.</li> <li>► Consult a qualified specialist workshop.</li> </ul> </li> </ul>
Stop Vehicle Leave Engine Running Wait Transmission Cooling	<ul style="list-style-type: none"> <li>* The transmission is overheating. Pulling away may be temporarily impaired or not possible.               <ul style="list-style-type: none"> <li>► Stop the vehicle immediately in accordance with the traffic conditions. Do not continue driving.</li> <li>► Leave the engine running.</li> <li>► Wait until the display message disappears before pulling away.</li> </ul> </li> </ul>
Auxiliary Battery Malfunction (white display message)	<ul style="list-style-type: none"> <li>* <b>Vehicles with automatic transmission:</b> The auxiliary battery for the transmission is no longer being charged.               <ul style="list-style-type: none"> <li>► Consult a qualified specialist workshop.</li> </ul> </li> </ul>

Display messages	Possible causes/consequences and ► Solutions
	<ul style="list-style-type: none"><li>► <b>Vehicles with automatic transmission:</b> Until then, always select park position <b>P</b> before you switch off the vehicle.</li><li>► Before leaving the vehicle, apply the electric parking brake.</li></ul>
Auxiliary Battery Malfunction (red display message)	<ul style="list-style-type: none"><li>* <b>Vehicles with automatic transmission:</b> The auxiliary battery for the transmission is no longer being charged.</li><li>► Consult a qualified specialist workshop.</li><li>► <b>Vehicles with automatic transmission:</b> Until then, always select park position <b>P</b> before you switch off the vehicle.</li><li>► Before leaving the vehicle, apply the electric parking brake.</li></ul>













## Brakes

Display messages	Possible causes/consequences and ► Solutions
<div data-bbox="203 290 360 372" data-label="Image"> </div> <p data-bbox="203 378 304 409">(USA only)</p> <div data-bbox="203 419 360 502" data-label="Image"> </div> <p data-bbox="203 507 341 538">(Canada only)</p> <p data-bbox="194 543 462 595">Parking Brake See Operator's Manual</p>	<ul style="list-style-type: none"> <li data-bbox="526 290 1339 315">* The yellow  indicator lamp is lit. The electric parking brake is malfunctioning.               <ul style="list-style-type: none"> <li data-bbox="545 326 637 352"><b>To apply:</b></li> <li data-bbox="545 357 1007 383">► Switch the vehicle off and switch it back on</li> <li data-bbox="545 388 1136 419">► Apply the electric parking brake manually (→ page 160).</li> </ul> <p data-bbox="545 445 1071 471">If it is not possible to apply the electric parking brake:</p> <ul style="list-style-type: none"> <li data-bbox="545 476 970 502">► Consult a qualified specialist workshop.</li> <li data-bbox="545 507 1256 538">► Where necessary, also secure the parked vehicle against rolling away.</li> </ul> </li> <li data-bbox="526 543 1690 600">* The yellow  indicator lamp and the red  (USA only) or  (Canada only) indicator lamp are lit. The electric parking brake is malfunctioning.               <ul style="list-style-type: none"> <li data-bbox="545 606 656 631"><b>To release:</b></li> <li data-bbox="545 637 1007 663">► Switch the vehicle off and switch it back on</li> <li data-bbox="545 668 1155 699">► Release the electric parking brake manually (→ page 160).</li> <li data-bbox="545 709 572 735">or</li> <li data-bbox="545 740 1201 771">► Release the electric parking brake automatically (→ page 160).</li> </ul> <p data-bbox="545 771 1127 797">If it is still not possible to release the electric parking brake:</p> <ul style="list-style-type: none"> <li data-bbox="545 802 1210 833">► Do not continue driving. Consult a qualified specialist workshop.</li> </ul> </li> </ul>

Display messages	Possible causes/consequences and ► Solutions
	<p>* The yellow  indicator lamp is lit and the red  (USA only) or  (Canada only) indicator lamp is flashing. The electric parking brake is malfunctioning.</p> <p>The electric parking brake could not be applied or released.</p> <ul style="list-style-type: none"><li>► Switch the vehicle off and switch it back on</li></ul> <p><b>To apply:</b></p> <ul style="list-style-type: none"><li>► Release and then apply the electric parking brake manually (→ page 160).</li></ul> <p><b>To release:</b></p> <ul style="list-style-type: none"><li>► Apply and then release the electric parking brake manually.</li></ul> <p>If the electric parking brake cannot be applied or the red  (USA only) or  (Canada only) indicator lamp continues to flash:</p> <ul style="list-style-type: none"><li>► Do not continue driving. Consult a qualified specialist workshop.</li><li>► Where necessary, also secure the parked vehicle against rolling away.</li></ul> <p>* The yellow  indicator lamp is lit and the red  (USA only) or  (Canada only) indicator lamp flashes for approximately ten seconds after the electric parking brake has been applied or released. It then remains lit or goes out. The electric parking brake is malfunctioning.</p> <p><b>If the state of charge is too low:</b></p> <ul style="list-style-type: none"><li>► Charge the 12 V battery.</li></ul>

Display messages	Possible causes/consequences and ► Solutions
	<p><b>To apply:</b></p> <ul style="list-style-type: none"><li>► Switch off the vehicle. The electric parking brake will be applied automatically.</li></ul> <p>If you do not want the electric parking brake to be applied, e.g. at an automatic car wash or when the vehicle is being towed, leave the vehicle switched on. This does not include having the vehicle towed with the rear axle raised.</p> <p>If the electric parking brake is not applied automatically:</p> <ul style="list-style-type: none"><li>► Switch the vehicle off and switch it back on</li><li>► Release and then apply the electric parking brake manually (→ page 160).</li></ul> <p>If it is still not possible to apply the electric parking brake:</p> <ul style="list-style-type: none"><li>► Consult a qualified specialist workshop.</li><li>► Where necessary, also secure the parked vehicle against rolling away.</li></ul> <p><b>To release:</b></p> <ul style="list-style-type: none"><li>► If the conditions for automatic release are fulfilled and the electric parking brake is not released automatically, release the electric parking brake manually (→ page 160).</li></ul> <p>If it is still not possible to release the electric parking brake:</p> <ul style="list-style-type: none"><li>► Do not continue driving. Consult a qualified specialist workshop.</li></ul>



Display messages	Possible causes/consequences and ► Solutions
 <p>(USA only)</p>  <p>(Canada only)</p> <p>Please Release Parking Brake</p>	<p>* The red  indicator lamp (USA only) or  indicator lamp (Canada only) is flashing.</p> <p>The electric parking brake is applied while you are driving:</p> <ul style="list-style-type: none"><li>• A condition for automatic release of the electric parking brake has not been fulfilled (→ page 160).</li><li>• You are performing emergency braking using the electric parking brake (→ page 161).</li></ul> <p>► Check the conditions for automatic release of the electric parking brake.</p> <p>► Release the electric parking brake manually.</p>



Display messages	Possible causes/consequences and ► Solutions
<div data-bbox="203 248 360 331"></div> <div data-bbox="203 341 304 367">(USA only)</div> <div data-bbox="203 378 360 461"></div> <div data-bbox="203 471 341 497">(Canada only)</div> <div data-bbox="194 502 462 554">Turn On the Ignition to Release the Parking Brake</div>	<p>* The red  (USA only) or  (Canada only) indicator lamp is lit. You have attempted to release the electric parking brake with the vehicle switched off.</p> <ul style="list-style-type: none"> <li>► Switch on the vehicle.</li> </ul>
<div data-bbox="203 580 360 663"></div> <div data-bbox="194 668 304 694">(USA only)</div> <div data-bbox="203 704 360 787"></div> <div data-bbox="194 797 332 823">(Canada only)</div> <div data-bbox="194 828 443 854">Check Brake Fluid Level</div>	<p>* There is insufficient brake fluid in the brake fluid reservoir.</p> <div data-bbox="554 621 1690 657" style="background-color: #cccccc; padding: 5px;"> <p><b>▲ WARNING</b> Risk of an accident due to low brake fluid level</p> </div> <p>If the brake fluid level is too low, the braking effect and the braking characteristics may be impaired.</p> <ul style="list-style-type: none"> <li>► Pull over and stop the vehicle safely as soon as possible, paying attention to road and traffic conditions. Do not continue driving under any circumstances.</li> <li>► Consult a qualified specialist workshop.</li> <li>► Do not add brake fluid.</li> </ul>



### 370 Display messages and warning/indicator lamps

Display messages	Possible causes/consequences and ► Solutions
<a href="#">Check Brake Pads See Operator's Manual</a>	<ul style="list-style-type: none"><li>* The brakepads have reached the wear limit.<ul style="list-style-type: none"><li>► Consult a qualified specialist workshop.</li></ul></li></ul>

### Driving systems

Display messages	Possible causes/consequences and ► Solutions
 <p>Off</p>	<ul style="list-style-type: none"><li>* The HOLD function is deactivated because the vehicle is slipping or a condition for activation is not fulfilled.<ul style="list-style-type: none"><li>► Reactivate the HOLD function later or check the activation conditions for the HOLD function (→ page 167).</li></ul></li></ul>
 <p>ATTENTION ASSIST Inoperative</p>	<ul style="list-style-type: none"><li>* ATTENTION ASSIST is malfunctioning.<ul style="list-style-type: none"><li>► Consult a qualified specialist workshop.</li></ul></li></ul>

Display messages	Possible causes/consequences and ► Solutions
 <p data-bbox="195 342 473 389">ATTENTION ASSIST: Take a Break!</p>	<ul style="list-style-type: none"> <li>* ATTENTION ASSIST has detected fatigue or an increasing lack of concentration on the part of the driver (→ page 168).               <ul style="list-style-type: none"> <li>► If necessary, take a break.</li> </ul> </li> </ul>
 <p data-bbox="195 511 279 532">--- mph</p>	<ul style="list-style-type: none"> <li>* Cruise control cannot be activated as not all activation conditions are fulfilled.               <ul style="list-style-type: none"> <li>► Observe the activation conditions for cruise control (→ page 171).</li> </ul> </li> </ul>
<p data-bbox="195 557 463 583">Cruise Control Inoperative</p>	<ul style="list-style-type: none"> <li>* Cruise control is malfunctioning.               <ul style="list-style-type: none"> <li>► Consult a qualified specialist workshop.</li> </ul> </li> </ul>
<p data-bbox="195 632 380 658">Cruise Control Off</p>	<ul style="list-style-type: none"> <li>* Cruise control has been deactivated.               <ul style="list-style-type: none"> <li>If there is an additional warning tone, cruise control has been deactivated automatically (→ page 170).</li> </ul> </li> </ul>
 <p data-bbox="195 801 279 822">--- mph</p>	<ul style="list-style-type: none"> <li>* Active Distance Assist DISTRONIC cannot be activated as not all activation conditions are fulfilled.               <ul style="list-style-type: none"> <li>► Comply with the activation conditions of Active Distance Assist DISTRONIC (→ page 174).</li> </ul> </li> </ul>

Display messages	Possible causes/consequences and ► Solutions
 <p>Suspended</p>	<p>* If you depress the accelerator pedal beyond the setting of Active Distance Assist DISTRONIC, the system will switch to passive mode (→ page 172).</p>
 <p>Off</p>	<p>* Active Distance Assist DISTRONIC was deactivated. If a warning tone also sounds, Active Distance Assist DISTRONIC has deactivated automatically (→ page 174).</p>
<p>Active Distance Assist Currently Unavailable See Operator's Manual</p>	<p>* Active Distance Assist DISTRONIC is temporarily unavailable. The ambient conditions are outside the system limits (→ page 172). As soon as the ambient conditions are within the system limits, the system will become available again.</p> <p>► Drive on. or ► If the display message does not disappear, stop the vehicle in accordance with the traffic conditions and restart the vehicle.</p>
<p>Active Distance Assist Inoperative</p>	<p>* Active Distance Assist DISTRONIC is malfunctioning. Other driving systems and driving safety systems may also be malfunctioning.</p> <p>► Drive on.</p>



Display messages	Possible causes/consequences and ► Solutions
	<p>or</p> <ul style="list-style-type: none"> <li>► Stop the vehicle in accordance with the traffic conditions and restart the vehicle.</li> <li>► If the display message does not disappear: consult a qualified specialist workshop.</li> </ul>
Active Distance Assist Now Available	<ul style="list-style-type: none"> <li>* Active Distance Assist DISTRONIC is operational again. <ul style="list-style-type: none"> <li>► Switch on Active Distance Assist DISTRONIC (→ page 174).</li> </ul> </li> </ul>
Active Steering Assist Currently Unavailable See Operator's Manual	<ul style="list-style-type: none"> <li>* Active Steering Assist is temporarily unavailable. The ambient conditions are outside the system limits (→ page 179). As soon as the ambient conditions are within the system limits, the system will become available again. <ul style="list-style-type: none"> <li>► Drive on</li> <li>► Check the tire pressure if necessary.</li> </ul> </li> </ul>
Active Steering Assist Inoperative	<ul style="list-style-type: none"> <li>* Active Steering Assist is malfunctioning. Active Distance Assist DISTRONIC remains available. <ul style="list-style-type: none"> <li>► Drive on</li> </ul> </li> </ul> <p>or</p> <ul style="list-style-type: none"> <li>► Stop the vehicle in accordance with the traffic conditions and restart the vehicle.</li> <li>► If the display message does not disappear: consult a qualified specialist workshop.</li> </ul>
Active Steering Asst. Currently Unavailable Due to Multiple Emergency Stops	<ul style="list-style-type: none"> <li>* Active Steering Assist is temporarily unavailable due to multiple emergency stops. <ul style="list-style-type: none"> <li>► Take over the steering and stop in accordance with the traffic conditions.</li> </ul> </li> </ul>







Display messages	Possible causes/consequences and ► Solutions
	<ul style="list-style-type: none"> <li>► Switch the vehicle off and switch it back on Active Steering Assist is available once more.</li> </ul>
<p>Beginning Emergency Stop</p>	<ul style="list-style-type: none"> <li>* Your hands are not on the steering wheel. An emergency stop is being initiated (→ page 181).               <ul style="list-style-type: none"> <li>► Put your hands back on the steering wheel.</li> </ul> <p>You can cancel the deceleration at any time by performing one of the following actions:</p> <ul style="list-style-type: none"> <li>• Steering</li> <li>• Braking or accelerating</li> <li>• Deactivating Active Distance Assist DISTRONIC</li> </ul> </li> </ul>
	<ul style="list-style-type: none"> <li>* Active Steering Assist has reached the system limits (→ page 179). You have not steered independently for a considerable period of time.               <ul style="list-style-type: none"> <li>► Take over the steering and drive on in accordance with the traffic conditions.</li> </ul> </li> </ul>
<p>Active Stop &amp; Go Assist Currently Unavailable See Operator's Manual</p>	<ul style="list-style-type: none"> <li>* Active Stop-and-Go Assist is temporarily unavailable. Active Distance Assist DISTRONIC and Active Steering Assist are still available. The ambient conditions are outside the system limits (→ page 178). As soon as the ambient conditions are within the system limits, the system will become available again.               <ul style="list-style-type: none"> <li>► Drive on.</li> </ul> </li> </ul>

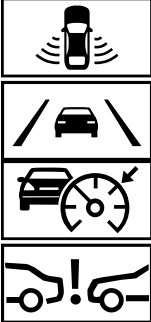

Display messages	Possible causes/consequences and ► Solutions
<p>Active Stop &amp; Go Assist Inoperative See Operator's Manual</p>	<p>* Active Stop-and-Go Assist is malfunctioning. Active Stop-and-Go Assist has been deactivated. Active Distance Assist DISTRONIC and Active Steering Assist are still available.</p> <ul style="list-style-type: none"> <li>► Drive on.</li> <li>or</li> <li>► Stop the vehicle in accordance with the traffic conditions and restart the vehicle.</li> <li>► If the display message does not disappear, consult a qualified specialist workshop.</li> </ul>
<p>Traffic Sign Assist Currently Unavailable See Operator's Manual</p>	<p>* Traffic Sign Assist is temporarily unavailable. Once the cause of the problem is no longer present, the system will be available again.</p> <ul style="list-style-type: none"> <li>► Drive on</li> </ul>
<p>Traffic Sign Assist Inoperative</p>	<p>* Traffic Sign Assist is malfunctioning.</p> <ul style="list-style-type: none"> <li>► Drive on</li> <li>or</li> <li>► Stop the vehicle in accordance with the traffic conditions and restart the vehicle.</li> <li>► If the display message does not disappear: consult a qualified specialist workshop.</li> </ul>
<p>Blind Spot Assist Currently Unavailable See Operator's Manual</p>	<p>* Blind Spot Assist is temporarily unavailable. The system limits have been reached (→ page 192). Once the cause of the problem is no longer present, the system will be available again.</p>

Display messages	Possible causes/consequences and ► Solutions
	<ul style="list-style-type: none"> <li>► Drive on</li> <li>or</li> <li>► If the display message does not disappear, stop the vehicle in accordance with the traffic conditions and restart the vehicle.</li> </ul>
Blind Spot Assist Inoperative	<p>* Blind Spot Assist is malfunctioning.</p> <ul style="list-style-type: none"> <li>► Drive on</li> <li>or</li> <li>► Stop the vehicle in accordance with the traffic conditions and restart the vehicle.</li> <li>► If the display message does not disappear: consult a qualified specialist workshop.</li> </ul>
Active Blind Spot Assist Currently Unavailable See Operator's Manual	<p>* Active Blind Spot Assist is temporarily unavailable. The system limits have been reached (→ page 192). Once the cause of the problem is no longer present, the system will be available again.</p> <ul style="list-style-type: none"> <li>► Drive on</li> <li>or</li> <li>► If the display message does not disappear, stop the vehicle in accordance with the traffic conditions and restart the vehicle.</li> </ul>
Active Blind Spot Assist Inoperative	<p>* Active Blind Spot Assist is malfunctioning.</p> <ul style="list-style-type: none"> <li>► Drive on</li> <li>or</li> </ul>





Display messages	Possible causes/consequences and ► Solutions
	<ul style="list-style-type: none"> <li>► Stop the vehicle in accordance with the traffic conditions and restart the vehicle.</li> <li>► If the display message does not disappear: consult a qualified specialist workshop.</li> </ul>
<p>Active Lane Keeping Assist Currently Unavailable See Operator's Manual</p>	<p>* Active Lane Keeping Assist is temporarily unavailable. The ambient conditions are outside the system limits (→ page 194). As soon as the ambient conditions are within the system limits, the system will become available again.</p> <ul style="list-style-type: none"> <li>► Drive on</li> </ul>
<p>Active Lane Keeping Assist Inoperative</p>	<p>* Active Lane Keeping Assist is malfunctioning.</p> <ul style="list-style-type: none"> <li>► Drive on</li> <li>or</li> <li>► Stop the vehicle in accordance with the traffic conditions and restart the vehicle.</li> <li>► If the display message does not disappear: consult a qualified specialist workshop.</li> </ul>

Display messages	Possible causes/consequences and ► Solutions
 <p data-bbox="144 598 389 646">Temporarily Unavailable Sensors are Dirty</p>	<p data-bbox="476 249 1363 273">* Front and corner radar sensors (hereafter "sensors") are malfunctioning. Possible causes:</p> <ul data-bbox="500 288 1153 377" style="list-style-type: none"><li data-bbox="500 288 735 308">• The sensors are dirty</li><li data-bbox="500 319 717 339">• Heavy rain or snow</li><li data-bbox="500 350 1153 377">• Extended country driving without other traffic, e.g. in the desert</li></ul> <p data-bbox="495 394 1646 443">Driving systems and driving safety systems may be malfunctioning or temporarily unavailable. The brake system, steering and drive system will continue to function normally.</p> <p data-bbox="495 456 611 480">► Drive on</p> <p data-bbox="495 505 1646 554">Once the causes of the problem are no longer present, the driving systems and driving safety systems will be available again and the corresponding symbols will be switched off.</p> <p data-bbox="495 567 912 591">If the display message does not disappear:</p> <ul data-bbox="495 605 1092 692" style="list-style-type: none"><li data-bbox="495 605 1092 625">► Stop the vehicle in accordance with the traffic conditions.</li><li data-bbox="495 636 1036 656">► Clean all sensor covers from outside (→ page 163).</li><li data-bbox="495 667 717 692">► Restart the vehicle.</li></ul>

Display messages	Possible causes/consequences and ► Solutions
 <p data-bbox="194 678 443 730">Temporarily Unavailable Camera View Restricted</p>	<p data-bbox="526 248 1201 274">* The view of the multifunction camera is restricted. Possible causes:</p> <ul data-bbox="545 279 1690 404" style="list-style-type: none"> <li>• Dirt on the windshield in the field of vision of the multifunction camera</li> <li>• Heavy rain, snow or fog</li> <li>• Condensation on the inside of the windshield: in certain weather conditions, condensation can form on the inside of the windshield during cold times of year in particular.</li> </ul> <p data-bbox="545 414 1700 471">  This condensation on the windshield will be removed automatically within a short time with the aid of a heater. The restriction is temporary.         </p> <p data-bbox="545 476 1700 533">Driving systems and driving safety systems may be malfunctioning or temporarily unavailable. The brake system, steering and drive system will continue to function normally.</p> <p data-bbox="545 538 665 564">  Drive on         </p> <p data-bbox="545 590 1700 647">Once the causes of the problem are no longer present, the driving systems and driving safety systems will be available again and the corresponding symbols will be switched off.</p> <p data-bbox="545 652 960 678">If the display message does not disappear:</p> <ul data-bbox="545 683 1469 782" style="list-style-type: none"> <li>  Stop the vehicle in accordance with the traffic conditions.           </li> <li>  Clean the windshield, especially in the position of the multifunction camera (→ page 163).           </li> <li>  Restart the vehicle.           </li> </ul>

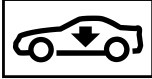

Display messages	Possible causes/consequences and ► Solutions
 <p data-bbox="144 339 408 391">Malfunction Drive at Max. 50 mph</p>	<ul style="list-style-type: none"> <li data-bbox="476 249 1604 275">* AIR BODY CONTROL is functioning only to a limited extent. The vehicle's handling characteristics may be affected.               <ul style="list-style-type: none"> <li data-bbox="495 282 1400 308">► Drive in a manner appropriate for the current level, but do not exceed 50 mph (80 km/h).</li> <li data-bbox="495 315 914 341">► Consult a qualified specialist workshop.</li> </ul> </li> <li data-bbox="476 349 1474 375">* DYNAMIC BODY CONTROL is malfunctioning. The vehicle's handling characteristics may be affected.               <ul style="list-style-type: none"> <li data-bbox="495 382 1068 408">► Do not drive at speeds greater than 50 mph (80 km/h).</li> <li data-bbox="495 415 914 441">► Consult a qualified specialist workshop.</li> </ul> </li> </ul>
 <p data-bbox="144 554 397 606">Stop Vehicle Vehicle Too Low</p>	<ul style="list-style-type: none"> <li data-bbox="476 464 1081 490">* You have pulled away despite the vehicle level being too low.               <ul style="list-style-type: none"> <li data-bbox="495 497 1090 543">► Stop the vehicle in accordance with the traffic conditions. The vehicle will be raised to the selected vehicle level.</li> <li data-bbox="495 551 1136 577">► Wait until the display message disappears before pulling away.</li> </ul> </li> </ul> <p data-bbox="495 605 1607 630">If the display message does not disappear and a warning tone also sounds, AIR BODY CONTROL is malfunctioning:</p> <ul style="list-style-type: none"> <li data-bbox="495 638 1617 664">► Do not drive at speeds greater than 50 mph (80 km/h) and consult a qualified specialist workshop immediately.</li> </ul> <div data-bbox="500 692 1646 836" style="border: 1px solid black; padding: 5px; margin-top: 10px;"> <p data-bbox="508 699 1478 725"><b>!</b> <b>NOTE</b> The tires on the front axle or the fenders could be damaged by large steering movements</p> <ul style="list-style-type: none"> <li data-bbox="508 740 1284 766">► Avoid large steering movements while driving and listen for scraping sounds.</li> <li data-bbox="508 773 1617 820">► If you hear scraping sounds, pull over and stop the vehicle in accordance with the traffic conditions, and set a higher vehicle level if possible.</li> </ul> </div>





Display messages	Possible causes/consequences and ► Solutions
	<ul style="list-style-type: none"> <li>► Set a higher vehicle level (→ page 197). Depending on the malfunction, the vehicle will be raised.</li> </ul>
 <p>Lowering</p>	<ul style="list-style-type: none"> <li>* The vehicle level will lower for the following reasons:               <ul style="list-style-type: none"> <li>• You have selected a different drive program.</li> <li>• You have exceeded the speed limit.</li> <li>• You have changed the vehicle level by pressing the button.</li> </ul> </li> </ul>
 <p>Vehicle Rising</p>	<ul style="list-style-type: none"> <li>* Your vehicle is adjusting to the level you have selected.</li> </ul>
 <p>Vehicle Rising Please Wait</p>	<ul style="list-style-type: none"> <li>* The vehicle level is too low. The vehicle will be raised to the selected vehicle level.               <ul style="list-style-type: none"> <li>► Wait until the display message disappears before pulling away.</li> </ul> </li> </ul>
 <p>Drive More Slowly</p>	<ul style="list-style-type: none"> <li>* You are driving too fast for the selected vehicle level.               <ul style="list-style-type: none"> <li>► To adjust the vehicle level, you must not drive at speeds greater than 37 mph (60 km/h).</li> </ul> </li> </ul>

Display messages	Possible causes/consequences and ► Solutions
<p>Parking Assist and PARKTRONIC Inoperative See Operator's Manual</p>	<p>* <b>Vehicles with Active Parking Assist:</b> Active Parking Assist and Parking Assist PARKTRONIC are malfunctioning.  <b>Vehicles without Active Parking Assist:</b> Parking Assist PARKTRONIC is malfunctioning.</p> <ul style="list-style-type: none"> <li>► Stop the vehicle in accordance with the traffic conditions and restart the vehicle.</li> <li>► If the display message still appears, consult a qualified specialist workshop.</li> </ul>

### Driving safety systems

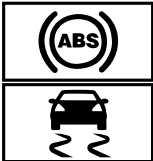
Display messages	Possible causes/consequences and ► Solutions
<div style="border: 1px solid black; padding: 5px; margin-bottom: 5px;">  </div> <div style="border: 1px solid black; padding: 5px;">  </div> <p>Currently Unavailable See Operator's Manual</p>	<p>* ABS and ESP® are temporarily unavailable.            Other driving systems and driving safety systems (e.g. BAS) may also be temporarily unavailable.            The brake system will continue to operate normally. Braking distance may increase in an emergency braking situation.</p> <div style="background-color: #f0f0f0; padding: 5px; margin-bottom: 5px;"> <p><b>▲ WARNING</b> Risk of skidding if ABS and ESP® are malfunctioning</p> </div> <p>The wheels may lock during braking and ESP® does not perform any vehicle stabilization.            The steerability and braking characteristics are heavily impaired and the braking distance may increase. In addition, other driving safety systems are switched off.</p> <ul style="list-style-type: none"> <li>► Drive carefully on a suitable stretch of road, making slight steering movements at a speed above 19 mph (30 km/h).</li> </ul>

Display messages	Possible causes/consequences and ► Solutions
	<p>► If the display message does not disappear, consult a qualified specialist workshop immediately. Drive carefully.</p>
 <p data-bbox="195 511 469 560">Inoperative See Operator's Manual</p>	<p>* ABS and ESP® are malfunctioning. Other driving systems and driving safety systems (e.g. BAS) may also be malfunctioning. The brake system will continue to operate normally. Braking distance may increase in an emergency braking situation.</p> <p><b>▲ WARNING</b> Risk of skidding if ABS and ESP® are malfunctioning</p> <p>The wheels may block during braking and ESP® does not perform any vehicle stabilization. The steerability and braking characteristics are heavily impaired and the braking distance may increase. In addition, other driving safety systems are switched off.</p> <p>► Drive on carefully. ► Have ABS and ESP® checked immediately at a qualified specialist workshop.</p>
 <p data-bbox="195 775 458 824">Currently Unavailable See Operator's Manual</p>	<p>* ESP® is temporarily unavailable. Other driving systems and driving safety systems (e.g. BAS) may also be malfunctioning.</p> <p><b>▲ WARNING</b> Risk of skidding if ESP is malfunctioning®</p> <p>If ESP® is malfunctioning, ESP® cannot carry out vehicle stabilization. In addition, other driving safety systems are switched off.</p>

Display messages	Possible causes/consequences and ► Solutions
	<ul style="list-style-type: none"> <li>► Drive carefully on a suitable stretch of road, making slight steering movements at a speed above 19 mph (30 km/h).</li> <li>► If the display message does not disappear, consult a qualified specialist workshop immediately. Drive carefully.</li> </ul>
 <p data-bbox="144 487 417 536">Inoperative See Operator's Manual</p>	<p data-bbox="476 394 726 420">* ESP® is malfunctioning.</p> <p data-bbox="495 430 1350 456">Other driving systems and driving safety systems (e.g. BAS) may also be malfunctioning.</p> <p data-bbox="495 467 1641 493">The brake system will continue to operate normally. Braking distance may increase in an emergency braking situation.</p> <div data-bbox="495 508 1646 550" style="background-color: #f0f0f0; padding: 5px;"> <p data-bbox="506 515 1064 541"><b>▲ WARNING</b> Risk of skidding if ESP® is malfunctioning</p> </div> <p data-bbox="510 560 1622 607">If ESP® is malfunctioning, ESP® cannot carry out vehicle stabilization. In addition, other driving safety systems are switched off.</p> <ul style="list-style-type: none"> <li>► Drive on carefully.</li> <li>► Have ESP® checked at a qualified specialist workshop.</li> </ul>

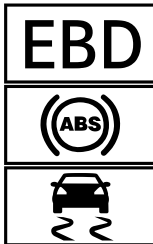
Display messages	Possible causes/consequences and ► Solutions
 <p data-bbox="194 512 471 564">Inoperative See Operator's Manual</p>	<p data-bbox="526 248 1404 310">* EBD, ABS and ESP® are malfunctioning. Other driving systems and driving safety systems (e.g. BAS) may also be malfunctioning.</p> <div data-bbox="545 326 1690 543" style="border: 1px solid gray; padding: 5px;"> <p data-bbox="554 336 1275 367"><b>▲ WARNING</b> Risk of skidding if EBD, ABS and ESP® are malfunctioning</p> <p data-bbox="563 378 1441 409">The wheels may block during braking and ESP® does not perform any vehicle stabilization.</p> <p data-bbox="563 414 1653 466">The steerability and braking characteristics are heavily impaired and the braking distance may increase. In addition, other driving safety systems are switched off.</p> <ul data-bbox="563 471 1367 533" style="list-style-type: none"> <li data-bbox="563 471 776 502">► Drive on carefully.</li> <li data-bbox="563 507 1367 533">► Have the brake system checked immediately at a qualified specialist workshop.</li> </ul> </div>
<p data-bbox="194 585 471 663">Active Brake Assist Functions Currently Limited See Operator's Manual</p>	<p data-bbox="526 585 1700 642">* <b>Vehicles with the Driving Assistance Package:</b> Active Brake Assist with cross-traffic function, Evasive Steering Assist or PRE-SAFE® PLUS are temporarily unavailable or only partially available.</p> <p data-bbox="545 647 1469 678"><b>Vehicles without the Driving Assistance Package:</b> Active Brake Assist is temporarily unavailable.</p> <ul data-bbox="545 683 1672 828" style="list-style-type: none"> <li data-bbox="545 683 1589 740">► Drive on. As soon as the ambient conditions are within the system limits, the system will become available again.</li> <li data-bbox="545 745 572 771">or</li> <li data-bbox="545 777 1672 828">► If the display message does not disappear, stop the vehicle in accordance with the traffic conditions and restart the vehicle.</li> </ul>

Display messages	Possible causes/consequences and ► Solutions
<p>Active Brake Assist Functions Limited See Operator's Manual</p>	<p>* For vehicles with the Driving Assistance Package, the following functions may be temporarily unavailable or only partially available:</p> <ul style="list-style-type: none"> <li>• Active Brake Assist with cross-traffic function</li> <li>• Evasive Steering Assist</li> <li>• PRE-SAFE® PLUS</li> </ul> <p><b>Vehicles without the Driving Assistance Package:</b> Active Brake Assist is temporarily unavailable or only partially available.</p> <p>► Drive on or ► Stop the vehicle in accordance with the traffic conditions and restart the vehicle. ► If the display message does not disappear: consult a qualified specialist workshop.</p>

### Mercedes-Benz emergency call system

Display messages	Possible causes/consequences and ► Solutions
 <p>Inoperative</p>	<p>* The Mercedes-Benz emergency call system is malfunctioning. The Mercedes me connect system is also malfunctioning.</p> <p>► Consult a qualified specialist workshop.</p>

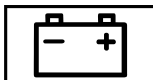
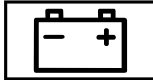

Display messages	Possible causes/consequences and ► Solutions
<p>Device Detected at Diagnostics Connection See Operator's Manual</p>	<ul style="list-style-type: none"> <li>* The vehicle functions for malfunction detection are restricted. At least one of the main functions of the Mercedes me connect system is malfunctioning.               <ul style="list-style-type: none"> <li>► Observe the notes on the diagnostics connection (→ page 24).</li> <li>► Consult a qualified specialist workshop.</li> </ul> </li> </ul>

## Battery

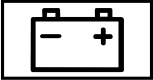
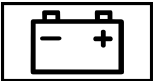
Display messages	Possible causes/consequences and ► Solutions
 <p>12 V Battery See Operator's Manual</p>	<ul style="list-style-type: none"> <li>* The vehicle is off and the charge level is too low.               <ul style="list-style-type: none"> <li>► Switch off electrical consumers that are not required.</li> </ul> <p>To charge the 12 V battery:</p> <ul style="list-style-type: none"> <li>► Leave the vehicle running for a few minutes, or drive an extended distance.</li> </ul> </li> <li>* If the message appears while the vehicle is switched on, this indicates an on-board electrical system malfunction.               <ul style="list-style-type: none"> <li>► Consult a qualified specialist workshop.</li> </ul> </li> </ul>
 <p>See Operator's Manual</p>	<ul style="list-style-type: none"> <li>* The 12 V battery is not being charged.               <div style="border: 1px solid black; padding: 5px; margin-top: 10px;"> <p><b>!</b> <b>NOTE</b> Possible engine damage if you continue driving</p> <ul style="list-style-type: none"> <li>► Do not continue driving under any circumstances.</li> </ul> </div> </li> </ul>

Display messages	Possible causes/consequences and ► Solutions
	<ul style="list-style-type: none"> <li>► Consult a qualified specialist workshop.</li> <li>► Stop immediately in accordance with the traffic conditions and switch off the vehicle.</li> <li>► Consult a qualified specialist workshop.</li> </ul>
 <p data-bbox="144 477 393 526">Stop Vehicle See Operator's Manual</p>	<p data-bbox="476 384 1258 410">* The 12 V battery is no longer being charged and the state of charge is too low.</p> <div data-bbox="500 425 1646 547" style="border: 1px solid black; padding: 5px;"> <p data-bbox="506 436 1073 462"><b>!</b> <b>NOTE</b> Possible engine damage if you continue driving</p> <ul style="list-style-type: none"> <li>► Do not continue driving under any circumstances.</li> <li>► Consult a qualified specialist workshop.</li> </ul> </div> <ul style="list-style-type: none"> <li>► Stop the vehicle immediately in accordance with the traffic conditions. Do not continue driving.</li> <li>► Switch off the vehicle.</li> <li>► Consult a qualified specialist workshop.</li> </ul>
 <p data-bbox="144 764 412 813">Stop Vehicle Leave Engine Running</p>	<p data-bbox="476 671 888 697">* The 12 V battery charge level is too low.</p> <ul style="list-style-type: none"> <li>► Stop the vehicle immediately in accordance with the traffic conditions. Do not continue driving.</li> <li>► Leave the engine running.</li> <li>► If the display message disappears: drive on.</li> <li>► If the display message does not disappear: consult a qualified specialist workshop.</li> </ul>





Display messages	Possible causes/consequences and ► Solutions
 <p data-bbox="194 341 443 393">48 V Battery See Operator's Manual</p>	<ul style="list-style-type: none"> <li>* The 48 V on-board electrical system has function restrictions. Comfort functions may be restricted.               <ul style="list-style-type: none"> <li>► Visit a qualified specialist workshop immediately.</li> </ul> </li> </ul>
 <p data-bbox="194 512 462 564">Please Wait Charging 48 V Battery...</p>	<ul style="list-style-type: none"> <li>* The 48 V battery is discharged. You have switched on the vehicle while the 12 V battery was being charged with a suitable charger or while another vehicle was providing starting assistance. The discharged 48 V battery is charged automatically via the voltage converter. After a few minutes, the <b>Engine Can Now Be Started</b> display message will be shown on the instrument display.               <ul style="list-style-type: none"> <li>► Start the vehicle.</li> <li>► Drive the vehicle for a while to charge the 12 V battery and the 48 V battery after disconnecting the charger from the vehicle.</li> </ul> <p>If the <b>Engine Can Now Be Started</b> display message does not appear after a few minutes:</p> <ul style="list-style-type: none"> <li>► Try to start the vehicle.</li> <li>► If the vehicle does not start, consult a qualified specialist workshop.</li> </ul> </li> </ul>
<p data-bbox="194 761 443 813">Cannot Start Engine See Operator's Manual</p>	<ul style="list-style-type: none"> <li>* The state of charge of the 48 V battery is too low. You can no longer start the vehicle.               <ul style="list-style-type: none"> <li>► Switch off electrical consumers that are not required.</li> </ul> </li> </ul>



### 390 Display messages and warning/indicator lamps

Display messages	Possible causes/consequences and ► Solutions
	<ul style="list-style-type: none"><li>► Connect a suitable charger approved for Mercedes-Benz with sufficient charge output to the jump-start connection point of the 12 V battery (→ page 291). The 48 V battery is charged via the voltage converter in the vehicle.</li></ul>
Engine Can Now Be Started	<ul style="list-style-type: none"><li>* The 48 V battery has been charged automatically via the voltage converter.<ul style="list-style-type: none"><li>► Start the vehicle and drive for a while to charge the 12 V battery and the 48 V battery.</li></ul></li></ul>

### Tire pressure monitor

Display messages	Possible causes/consequences and ► Solutions
Tire Press. Monitor Currently Unavailable	<ul style="list-style-type: none"><li>* There is interference from a powerful radio signal source. As a result, no signals from the tire pressure sensors are being received. The tire pressure monitoring system is temporarily unavailable. The tire pressure monitoring system will restart automatically as soon as the cause has been rectified.<ul style="list-style-type: none"><li>► Drive on.</li></ul></li></ul>
Tire Press. Monitor Inoperative	<ul style="list-style-type: none"><li>* The tire pressure monitoring system is malfunctioning.<div data-bbox="495 723 1646 871" style="border: 1px solid gray; padding: 5px;"><p><b>⚠ WARNING</b> There is a risk of an accident if the tire pressure monitoring system is malfunctioning</p><p>The tire pressure monitoring system cannot issue a warning if there is pressure loss in one or more of the tires. Tires with insufficient tire pressure may impair the driving characteristics as well as steering and braking.</p><ul style="list-style-type: none"><li>► Have the tire pressure monitoring system checked at a qualified specialist workshop.</li></ul></div></li></ul>

Display messages	Possible causes/consequences and ► Solutions
<p>Tire Pressure Monitor Inoperative No Wheel Sensors</p>	<p>* The wheels installed do not have suitable tire pressure sensors. The tire pressure monitoring system is deactivated.</p> <p>► Install wheels with suitable tire pressure sensors.</p>
<p></p> <p>Wheel Sensor(s) Missing</p>	<p>* There is no signal from the tire pressure sensor of one or more wheels. No pressure value is displayed for the affected tire.</p> <p>► Have the faulty tire pressure sensor replaced at a qualified specialist workshop.</p>
<p></p> <p>Check Tires</p>	<p>* The tire pressure in one or more tires has dropped significantly. The wheel position is displayed. A warning tone will also sound.</p> <div style="border: 1px solid gray; padding: 5px; margin: 10px 0;"> <p><b>⚠ WARNING</b> Risk of an accident due to insufficient tire pressure</p> <ul style="list-style-type: none"> <li>• The tires can burst.</li> <li>• The tires can wear excessively and/or unevenly.</li> <li>• The driving characteristics as well as the steering and braking may be greatly impaired.</li> </ul> <p>You could then lose control of the vehicle.</p> <p>► Observe the recommended tire pressures.</p> <p>► Adjust the tire pressure if necessary.</p> </div> <p>► Stop the vehicle in accordance with the traffic conditions.</p> <p>► Check the tire pressure (→ page 302) and the tires.</p>

Display messages	Possible causes/consequences and ► Solutions
 <p data-bbox="144 342 397 391">Please Correct Tire Pressure</p>	<p data-bbox="476 249 1641 301">* The tire pressure is too low in at least one of the tires, or the difference in tire pressure between the individual wheels is too great.</p> <ul style="list-style-type: none"> <li data-bbox="495 311 1007 335">► Check the tire pressure and add air, if necessary.</li> <li data-bbox="495 346 1326 369">► When the tire pressure is correct, restart the tire pressure monitor (→ page 307).</li> </ul>
 <p data-bbox="144 511 397 535">Warning Tire Malfunction</p>	<p data-bbox="476 418 1443 442">* The tire pressure in one or more tires has dropped suddenly. The wheel position will be displayed.</p> <div data-bbox="495 459 1646 750" style="border: 1px solid gray; padding: 5px;"> <p data-bbox="506 467 1110 491"><b>▲ WARNING</b> Risk of an accident from driving with a flat tire</p> <ul style="list-style-type: none"> <li data-bbox="519 508 938 532">• The tires can overheat and be damaged.</li> <li data-bbox="519 542 1541 566">• The driving characteristics as well as the steering and braking characteristics may be greatly impaired.</li> </ul> <p data-bbox="513 584 920 608">You could then lose control of the vehicle.</p> <ul style="list-style-type: none"> <li data-bbox="513 618 814 642">► Do not drive with a flat tire.</li> <li data-bbox="513 652 1600 701">► Do not exceed the maximum permissible driving distance in emergency mode and the maximum permissible speed with a flat MOExtended tire.</li> <li data-bbox="513 711 851 735">► Observe the notes on flat tires.</li> </ul> </div> <p data-bbox="495 767 944 791">Notes in the event of a flat tire (→ page 282).</p> <ul style="list-style-type: none"> <li data-bbox="495 801 1092 825">► Stop the vehicle in accordance with the traffic conditions.</li> <li data-bbox="495 836 685 859">► Check the tires.</li> </ul>



Display messages	Possible causes/consequences and ► Solutions
Tires Overheated	<p>* At least one tire is overheating. The affected tires are displayed in red. At temperatures close to the limit value, the tires are displayed in yellow.</p> <p><b>▲ WARNING</b> Risk of an accident from driving with overheated tires</p> <p>Overheated tires can burst.</p> <p>► Reduce speed so that the tires cool down.</p>
Decrease Speed	<p>* At least one tire is overheating. The affected tires are displayed in red. At temperatures close to the limit value, the tires are displayed in yellow.</p> <p><b>▲ WARNING</b> Risk of an accident from driving with overheated tires</p> <p>Overheated tires can burst.</p> <p>► Reduce speed so that the tires cool down.</p>



### Tire pressure loss warning system

Display messages	Possible causes/consequences and ► Solutions
Check Tire Pressure Soon	<p>* Canada only: The tire pressure loss warning system has detected a significant loss of pressure.</p>

Display messages	Possible causes/consequences and ► Solutions
	<p><b>▲ WARNING</b> Risk of an accident due to insufficient tire pressure</p> <ul style="list-style-type: none"> <li>• The tires can burst.</li> <li>• The tires can wear excessively and/or unevenly.</li> <li>• The driving characteristics as well as the steering and braking may be greatly impaired.</li> </ul> <p>You could then lose control of the vehicle.</p> <ul style="list-style-type: none"> <li>► Observe the recommended tire pressures.</li> <li>► Adjust the tire pressure if necessary.</li> </ul> <ul style="list-style-type: none"> <li>► Stop the vehicle in accordance with the traffic conditions.</li> <li>► Check the tire pressure (→ page 302) and the tires.</li> <li>► When the tire pressure is correct, restart the tire pressure loss warning system (→ page 307).</li> </ul>
Check Tire Pressure Then Restart Run Flat Indicator	<p>* Canada only: The tire pressure loss warning system generated a display message and has not been restarted since.</p> <ul style="list-style-type: none"> <li>► When the tire pressure is correct, restart the tire pressure loss warning system (→ page 307).</li> </ul>
Run Flat Indicator Inoperative	<p>* Canada only: The tire pressure loss warning system is malfunctioning.</p> <ul style="list-style-type: none"> <li>► Consult a qualified specialist workshop.</li> </ul>

## Engine oil

Display messages	Possible causes/consequences and ► Solutions
 <p data-bbox="195 381 426 433">Check Engine Oil Level (Add 1 quart)</p>	<p data-bbox="528 288 1073 313">* The engine oil level has dropped to the minimum level.</p> <div data-bbox="550 332 1696 415" style="border: 1px solid gray; padding: 5px;"> <p data-bbox="559 339 1249 365">! <b>NOTE</b> Engine damage caused by driving with insufficient engine oil</p> <p data-bbox="559 381 1055 407">► Avoid long journeys with insufficient engine oil.</p> </div> <p data-bbox="541 433 1240 458">► When next refueling, add 1.1 US qt (1 l) of engine oil (→ page 271).</p> <p data-bbox="541 474 888 500">Notes on engine oil (→ page 339).</p>
 <p data-bbox="195 612 473 638">Engine Oil Reduce Oil Level</p>	<p data-bbox="528 519 842 544">* The engine oil level is too high.</p> <div data-bbox="550 563 1696 646" style="border: 1px solid gray; padding: 5px;"> <p data-bbox="559 570 1212 596">! <b>NOTE</b> Engine damage caused by driving with excess engine oil</p> <p data-bbox="559 612 1012 638">► Avoid long journeys with excess engine oil.</p> </div> <p data-bbox="541 664 1456 689">► Consult a qualified specialist workshop immediately and have the engine oil level reduced.</p>
 <p data-bbox="195 795 458 847">Engine Oil Level Low Stop Vehicle Turn Engine Off</p>	<p data-bbox="528 702 833 728">* The engine oil level is too low.</p> <div data-bbox="550 746 1696 829" style="border: 1px solid gray; padding: 5px;"> <p data-bbox="559 754 1249 780">! <b>NOTE</b> Engine damage caused by driving with insufficient engine oil</p> <p data-bbox="559 795 1055 821">► Avoid long journeys with insufficient engine oil.</p> </div> <p data-bbox="541 847 1507 873">► Stop the vehicle immediately in accordance with the traffic conditions. Do not continue driving.</p>

Display messages	Possible causes/consequences and ► Solutions
	<ul style="list-style-type: none"> <li>► Switch off the vehicle.</li> <li>► Add 1.1 US qt (1 l) of engine oil (→ page 271).</li> <li>► Check the engine oil level.</li> </ul> <p>Notes on engine oil (→ page 339).</p>
 <p>Engine Oil Pressure Stop Switch Off Engine</p>	<p>* The oil pressure is too low.</p> <div style="border: 1px solid black; padding: 5px; margin: 5px 0;"> <p><b>!</b> <b>NOTE</b> Engine damage caused by driving with insufficient oil pressure</p> <p>► Avoid driving with insufficient oil pressure.</p> </div> <ul style="list-style-type: none"> <li>► Stop the vehicle immediately in accordance with the traffic conditions. Do not continue driving.</li> <li>► Switch off the vehicle.</li> <li>► Consult a qualified specialist workshop.</li> </ul>
 <p>Engine Oil Level Cannot Be Measured</p>	<p>* The electrical connection to the oil level sensor has been interrupted or the oil level sensor is faulty.</p> <ul style="list-style-type: none"> <li>► Consult a qualified specialist workshop.</li> </ul>



## Warning and indicator lamps

### Overview of indicator and warning lamps





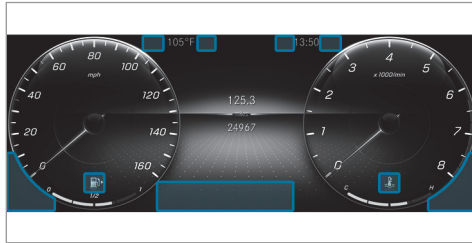

Some systems will perform a self-test when the vehicle is switched on. Some indicator and warning lamps may briefly light up or flash. This behavior is non-critical. These indicator and warning lamps indicate a malfunction only if they light up or flash after the vehicle has been started or during a journey.













### Instrument display





Depending on the display setting, the positions of the indicator lamps on the instrument display may differ from the example shown.

### Indicator and warning lamps:

-  Restraint system (→ page 398)
-  Seat belt (→ page 398)
-  Power steering (→ page 399)
-  Coolant temperature (→ page 400)
-  Check Engine (→ page 400)
-  Electrical malfunction (→ page 400)
-  Reserve fuel with fuel filler flap location indicator (→ page 400)
- PARK** USA: electric parking brake (red) (→ page 404)
- (P)** Canada: electric parking brake (red) (→ page 404)
- (P)** Electric parking brake (yellow) (→ page 404)
- RBS** USA: Recuperative Brake System (→ page 404)
- (D)** Canada: brakes (yellow) (→ page 404)
- BRAKE** USA: brakes (red) (→ page 404)
- (D)** Canada: brakes (red) (→ page 404)

-  Distance warning (→ page 407)
-  Active Brake Assist (→ page 407)
-  Active Brake Assist (→ page 407)
-  AIR BODY CONTROL (→ page 407)
-  DYNAMIC BODY CONTROL (→ page 407)
- (ABS)** ABS (→ page 408)
-  ESP® (→ page 408)
-  ESP® OFF (→ page 408)
-  Tire pressure monitoring system (→ page 411)
-  Parking lights (→ page 111)
-  Low beam (→ page 111)
-  High beam (→ page 112)
-  Turn signal lights (→ page 112)
-  Rear fog light (→ page 111)

## Occupant safety

Warning/indicator lamp	Possible causes/consequences and ► Solutions
 <p data-bbox="144 381 395 433">Restraint system warning lamp</p>	<p data-bbox="463 288 1123 339">* The restraint system red warning lamp is lit while the vehicle is on. The restraint system is malfunctioning (→ page 34).</p> <div data-bbox="482 360 1646 474" style="border: 1px solid gray; padding: 5px;"> <p data-bbox="491 365 1193 391"><b>▲ WARNING</b> Risk of injury due to malfunctions in the restraint system</p> <p data-bbox="491 407 1559 433">Components in the restraint system may be activated unintentionally or not deploy as planned in an accident.</p> <p data-bbox="491 438 1456 464">► Have the restraint system checked and repaired immediately at a qualified specialist workshop.</p> </div> <ul data-bbox="476 490 1018 588" style="list-style-type: none"> <li data-bbox="476 490 689 515">► Drive on carefully.</li> <li data-bbox="476 521 957 547">► Note the messages on the instrument display.</li> <li data-bbox="476 552 1018 588">► Consult a qualified specialist workshop immediately.</li> </ul>
 <p data-bbox="144 695 371 746">Seat belt warning lamp flashes</p>	<p data-bbox="463 601 1387 653">* The red seat belt warning lamp flashes and an intermittent warning tone sounds. The driver or front passenger has not fastened his/her seat belt while the vehicle is in motion.</p> <ul data-bbox="476 658 1009 746" style="list-style-type: none"> <li data-bbox="476 658 855 684">► Fasten your seat belt (→ page 38).</li> <li data-bbox="476 689 929 715">There are objects on the front passenger seat.</li> <li data-bbox="476 721 1009 746">► Remove the objects from the front passenger seat.</li> </ul>

Warning/indicator lamp	Possible causes/consequences and ► Solutions
 <p data-bbox="194 341 425 393">Seat belt warning lamp lights up</p>	<p data-bbox="508 248 1358 274">* The red seat belt warning lamp lights up for six seconds once the vehicle has started.</p> <p data-bbox="526 284 1044 310">In addition, an intermittent warning tone may sound.</p> <p data-bbox="526 310 1469 336">The red seat belt warning lamp reminds the driver and front passenger to fasten their seat belts.</p> <p data-bbox="526 341 914 367">► Fasten your seat belt (→ page 38).</p> <p data-bbox="526 383 1524 409">If you have placed objects on the front passenger seat, the red seat belt warning lamp may remain lit.</p>



## Vehicle

Warning/indicator lamp	Possible causes/consequences and ► Solutions
 <p data-bbox="194 645 425 697">Power steering warning lamp (red)</p>	<p data-bbox="508 552 1210 578">* The red power steering warning lamp is lit while the vehicle is running.</p> <p data-bbox="526 578 1118 603">The power assistance or the steering itself is malfunctioning.</p> <div data-bbox="526 621 1700 802" style="border: 1px solid gray; padding: 5px;"> <p data-bbox="535 626 1173 652"><b>⚠ WARNING</b> Risk of accident if steering capability is impaired</p> <p data-bbox="545 668 1432 694">If the steering does not function as intended, the vehicle's operating safety is jeopardized.</p> <ul style="list-style-type: none"> <li data-bbox="545 704 1672 756">► Pull over and stop the vehicle safely as soon as possible, paying attention to road and traffic conditions. Do not continue driving under any circumstances.</li> <li data-bbox="545 766 970 792">► Consult a qualified specialist workshop.</li> </ul> </div> <p data-bbox="526 813 1007 839">► Note the messages on the instrument display.</p>

## Engine

Warning/indicator lamp	Possible causes/consequences and ► Solutions
 <p data-bbox="144 381 413 408">Coolant warning lamp (red)</p>	<p data-bbox="462 288 1086 314">* The red coolant warning lamp is lit while the engine is running.</p> <p data-bbox="476 323 643 346">Possible causes:</p> <ul data-bbox="484 358 927 520" style="list-style-type: none"><li data-bbox="484 358 920 381">• The temperature sensor is malfunctioning</li><li data-bbox="484 391 779 414">• The coolant level is too low</li><li data-bbox="484 424 927 447">• The air supply to the radiator is obstructed</li><li data-bbox="484 457 750 480">• The radiator fan is faulty</li><li data-bbox="484 491 842 513">• The engine coolant pump is faulty</li></ul> <p data-bbox="476 536 1611 563">If there is an additional warning tone, the coolant temperature has exceeded the maximum permissible temperature.</p> <div data-bbox="484 582 1646 837" style="border: 1px solid gray; padding: 5px;"><p data-bbox="491 588 1005 615"><b>▲ WARNING</b> Risk of burns when opening the hood</p><p data-bbox="495 627 1629 679">If you open the hood in the event of an overheated engine or fire in the engine compartment, the following situations may occur:</p><ul data-bbox="502 689 1193 747" style="list-style-type: none"><li data-bbox="502 689 949 712">• You may come into contact with hot gases.</li><li data-bbox="502 723 1193 747">• You may come into contact with other escaping hot operating fluids.</li></ul><p data-bbox="495 764 1082 791">► Before opening the hood, allow the engine to cool down.</p><p data-bbox="495 801 1456 826">► In the event of a fire in the engine compartment, keep the hood closed and call the fire service.</p></div> <p data-bbox="476 851 1581 878">► Stop immediately in accordance with the traffic conditions and switch off the vehicle. Do not continue driving.</p>

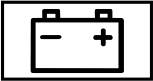
Warning/indicator lamp	Possible causes/consequences and ► Solutions
	<p>► Note the messages on the instrument display.</p> <p><b>If the coolant temperature display is at the lower end of the temperature scale:</b></p> <p>► Consult a qualified specialist workshop.</p> <p><b>If the coolant temperature display is at the upper end of the temperature scale:</b></p> <p>► Exit the vehicle and keep a safe distance from it until the engine has cooled down.</p> <p>► Check the coolant level (→ page 272).</p> <p>► Make sure that the air supply to the radiator is not obstructed.</p> <p>► Avoiding high loads on the engine, drive to the nearest qualified specialist workshop. In doing so, ensure that the coolant temperature display remains below the red area.</p>
 <p>Coolant warning lamp (yellow)</p>	<p>* The yellow coolant warning lamp is lit while the engine is running.</p> <p>Possible causes:</p> <ul style="list-style-type: none"> <li>• The temperature sensor is malfunctioning</li> <li>• The charge air, transmission oil or battery cooling is faulty</li> <li>• The radiator shutters are blocked or defective</li> </ul> <p>► Avoiding high loads on the engine, drive to the nearest qualified specialist workshop.</p>

Warning/indicator lamp	Possible causes/consequences and ► Solutions
 <p data-bbox="144 342 395 391">Engine diagnosis warning lamp</p>	<p data-bbox="463 249 1631 394">* The yellow Check Engine warning lamp is lit while the engine is running. A malfunction has occurred in the engine, the exhaust system or the fuel system. The emission limit values may be exceeded and the engine may be in emergency mode. In some states, legal requirements stipulate that you must immediately consult a qualified specialist workshop as soon as the yellow Check Engine warning lamp lights up.</p> <p data-bbox="476 405 1291 428">► Have the vehicle checked as soon as possible at a qualified specialist workshop.</p>
 <p data-bbox="144 539 421 588">Electrical malfunction warning lamp</p>	<p data-bbox="463 446 959 495">* The red electrical malfunction warning lamp is lit. There is a malfunction in the electrics.</p> <p data-bbox="476 505 959 529">► Note the messages on the instrument display.</p>
 <p data-bbox="144 698 404 746">Fuel reserve warning lamp flashes</p>	<p data-bbox="463 605 1628 653">* The yellow fuel reserve warning lamp lights up while you are driving. There has been pressure loss in the fuel system. The fuel filler cap is not closed correctly or the fuel system is leaking.</p> <p data-bbox="476 664 744 687">► Close the fuel filler cap.</p> <p data-bbox="476 715 999 739">If the fuel filler cap has already been closed correctly:</p> <p data-bbox="476 750 898 773">► Consult a qualified specialist workshop.</p>

**Warning/indicator lamp**



Fuel reserve warning lamp  
lights up

**Possible causes/consequences and ► Solutions**





\* The yellow fuel reserve warning lamp lights up while the engine is running.  
The fuel supply has dropped into the reserve range.



► Refuel.

## Brakes



Warning/indicator lamp	Possible causes/consequences and ► Solutions
<p data-bbox="155 291 310 373"></p> <p data-bbox="144 381 413 433">Electric parking brake indicator lamp (red) (USA only)</p> <p data-bbox="155 439 310 522"></p> <p data-bbox="144 529 413 607">Electric parking brake indicator lamp (red) (Canada only)</p> <p data-bbox="155 613 310 696"></p> <p data-bbox="144 703 402 755">The electric parking brake (yellow) indicator lamp</p>	<p data-bbox="463 291 1068 314">* The red electric parking brake indicator lamp flashes or is lit.</p> <p data-bbox="476 322 1326 346">The yellow electric parking brake indicator lamp is also lit in the event of a malfunction.</p> <ul data-bbox="476 353 962 377" style="list-style-type: none"><li data-bbox="476 353 962 377">► Note the messages on the instrument display.</li></ul>



Warning/indicator lamp	Possible causes/consequences and ► Solutions
 <p>Recuperative Brake System warning lamp (USA only)</p>  <p>Brakes warning lamp (yellow) (Canada only)</p>	<p>*The yellow  warning lamp (USA only) or the yellow  brake warning lamp (Canada only) is lit while the vehicle is running.</p> <p><b>▲ WARNING</b> Risk of an accident due to a brake system malfunction</p> <p>If the brake system is malfunctioning, braking characteristics may be impaired.</p> <ul style="list-style-type: none"><li>▶ Drive on carefully.</li><li>▶ Have the brake system checked immediately at a qualified specialist workshop.</li></ul> <p>► Adjust your speed and drive on carefully, leaving a suitable distance to the vehicle in front.</p> <p>► If the instrument display shows a display message, observe it.</p> <p>► Consult a qualified specialist workshop.</p>

Warning/indicator lamp	Possible causes/consequences and ► Solutions
 <p>Brake warning lamp (USA only)</p>  <p>Brake system warning lamp (Canada only)</p>	<p>* The red brake warning lamp is lit while the vehicle is running.</p> <p>Possible causes:</p> <ul style="list-style-type: none"><li>• The brake force boosting is malfunctioning and the braking characteristics may be affected.</li><li>• There is insufficient brake fluid in the brake fluid reservoir.</li></ul> <p>► Note the messages on the instrument display.</p> <p><b>▲ WARNING</b> Risk of accident and injury if brake force boosting is malfunctioning</p> <p>If brake force boosting is malfunctioning, increased brake pedal force may be necessary for braking. The braking characteristics may be impaired. The braking distance can increase in emergency braking situations.</p> <ul style="list-style-type: none"><li>► Stop in a safe location immediately. Do not continue driving.</li><li>► Consult a qualified specialist workshop.</li></ul> <p><b>▲ WARNING</b> Risk of an accident due to low brake fluid level</p> <p>If the brake fluid level is too low, the braking effect and the braking characteristics may be impaired.</p> <ul style="list-style-type: none"><li>► Pull over and stop the vehicle safely as soon as possible, paying attention to road and traffic conditions. Do not continue driving under any circumstances.</li><li>► Consult a qualified specialist workshop.</li><li>► Do not add brake fluid.</li></ul>



## Driving systems

Warning/indicator lamp	Possible causes/consequences and ► Solutions
 <p data-bbox="194 383 471 435">Warning lamp for distance warning function</p>	<p data-bbox="508 290 1210 341">* The red distance warning lamp lights up while the vehicle is in motion. The distance to the vehicle in front is too small for the speed selected.</p> <p data-bbox="526 352 1413 378">If there is an additional warning tone, you are approaching an obstacle at too high a speed.</p> <ul style="list-style-type: none"> <li data-bbox="526 388 896 414">► Be prepared to brake immediately.</li> <li data-bbox="526 419 785 445">► Increase the distance.</li> </ul> <p data-bbox="526 461 979 486">Function of Active Brake Assist (→ page 183).</p>
 <p data-bbox="194 595 471 647">Active Brake Assist warning lamp</p>	<p data-bbox="508 507 1533 559">* The Active Brake Assist warning lamp is on. Due to dirty sensors or a malfunction, the system is not available or the range of functions is restricted.</p> <ul style="list-style-type: none"> <li data-bbox="526 564 1007 590">► Note the messages on the instrument display.</li> </ul>
 <p data-bbox="194 756 471 808">Active Brake Assist warning lamp</p>	<p data-bbox="508 668 1367 720">* The Active Brake Assist warning lamp is on. The system is switched off or the range of functions has been automatically restricted.</p> <p data-bbox="526 725 1543 751">This may be the case if the driver is not wearing a seat belt or another driving system has been activated.</p> <ul style="list-style-type: none"> <li data-bbox="526 756 1118 782">► Observe the notes on Active Brake Assist (→ page 183).</li> </ul>

Warning/indicator lamp	Possible causes/consequences and ► Solutions
 <p data-bbox="144 342 397 394">Suspension warning lamp (yellow)</p>	<p data-bbox="458 249 1086 368">* The yellow AIR BODY CONTROL warning lamp is lit. The yellow DYNAMIC BODY CONTROL warning lamp is lit. A malfunction has occurred in the AIR BODY CONTROL. A malfunction has occurred in the DYNAMIC BODY CONTROL.</p> <p data-bbox="476 379 959 404">► Note the messages on the instrument display.</p>

### Driving safety systems

Warning/indicator lamp	Possible causes/consequences and ► Solutions
 <p data-bbox="144 638 323 663">ABS warning lamp</p>	<p data-bbox="458 544 1230 664">* The yellow ABS warning lamp is lit while the vehicle is running. ABS is malfunctioning. If an additional warning tone sounds, EBD is malfunctioning. Other driving systems and driving safety systems may also be malfunctioning.</p> <p data-bbox="476 674 959 699">► Note the messages on the instrument display.</p> <div data-bbox="482 715 1646 754" style="background-color: #f0f0f0; padding: 5px;"> <p data-bbox="491 726 1203 751"><b>▲ WARNING</b> There is a risk of skidding if EBD or ABS is malfunctioning</p> </div> <p data-bbox="491 764 1618 850">The wheels may lock during braking. The steerability and braking characteristics are heavily impaired and the braking distance may increase. In addition, other driving safety systems are switched off.</p>

Warning/indicator lamp	Possible causes/consequences and ► Solutions
	<ul style="list-style-type: none"> <li>► Drive on carefully.</li> <li>► Have the brake system checked immediately at a qualified specialist workshop.</li> </ul>
 <p>ESP® warning lamp flashes</p>	<p>* The yellow ESP® warning lamp flashes while the vehicle is in motion. One or more wheels have reached their grip limit (→ page 165).</p> <ul style="list-style-type: none"> <li>► Adapt your driving style to suit the road and weather conditions.</li> </ul>
 <p>ESP® warning lamp lights up</p>	<p>* The yellow ESP® warning lamp is lit while the vehicle is running. ESP® is malfunctioning. Other driving systems and driving safety systems (e.g. BAS) may also be malfunctioning.</p> <ul style="list-style-type: none"> <li>► Note the messages on the instrument display.</li> </ul> <div style="background-color: #e0e0e0; padding: 5px; border: 1px solid #ccc;"> <p><b>▲ WARNING</b> Risk of skidding if ESP® is malfunctioning</p> <p>If ESP® is malfunctioning, ESP® cannot carry out vehicle stabilization. In addition, other driving safety systems are switched off.</p> <ul style="list-style-type: none"> <li>► Drive on carefully.</li> <li>► Have ESP® checked at a qualified specialist workshop.</li> </ul> </div>

Warning/indicator lamp



ESP® OFF warning lamp

Possible causes/consequences and ► Solutions

- \* The yellow ESP® OFF warning lamp is lit while the vehicle is running. ESP® is deactivated. Other driving systems and driving safety systems may also be inoperative.

**▲ WARNING** Risk of skidding when driving with ESP® deactivated

ESP® does not act to stabilize the vehicle. The availability of further driving safety systems is also limited.



- Drive on carefully.
- Deactivate ESP® only for as long as the situation requires.

If ESP® cannot be activated, ESP® is malfunctioning.

- Have ESP® checked immediately at a qualified specialist workshop.

- Observe the notes on deactivating ESP® (→ page 165).

## Tire pressure monitor

Warning/indicator lamp	Possible causes/consequences and ► Solutions
 <p data-bbox="194 383 480 429">Tire pressure monitoring system warning lamp flashes</p>	<p data-bbox="517 290 1681 367">*The yellow tire pressure monitor warning lamp (pressure loss/malfunction) flashes for approximately one minute and then remains lit. The tire pressure monitor is malfunctioning.</p> <div data-bbox="535 383 1690 533" style="border: 1px solid gray; padding: 5px;"> <p data-bbox="545 393 1524 419"><b>▲ WARNING</b> There is a risk of an accident if the tire pressure monitoring system is malfunctioning</p> <p data-bbox="545 429 1635 492">The tire pressure monitoring system cannot issue a warning if there is pressure loss in one or more of the tires. Tires with insufficient tire pressure may impair the driving characteristics as well as steering and braking.</p> <p data-bbox="545 502 1413 528">► Have the tire pressure monitoring system checked at a qualified specialist workshop.</p> </div>
 <p data-bbox="194 647 471 720">Tire pressure monitoring system warning lamp lights up</p>	<p data-bbox="517 554 1450 600">* The yellow tire pressure monitoring system warning lamp (pressure loss/malfunction) is lit. The tire pressure monitoring system has detected tire pressure loss in at least one of the tires.</p> <div data-bbox="535 621 1690 875" style="border: 1px solid gray; padding: 5px;"> <p data-bbox="545 631 1191 657"><b>▲ WARNING</b> Risk of an accident due to insufficient tire pressure</p> <ul data-bbox="554 668 1432 761" style="list-style-type: none"> <li>• The tires can burst.</li> <li>• The tires can wear excessively and/or unevenly.</li> <li>• The driving characteristics as well as the steering and braking may be greatly impaired.</li> </ul> <p data-bbox="545 777 960 802">You could then lose control of the vehicle.</p> <p data-bbox="545 813 997 870">► Observe the recommended tire pressures. ► Adjust the tire pressure if necessary.</p> </div>

## 412 Display messages and warning/indicator lamps

---

Warning/indicator lamp	Possible causes/consequences and ▶ Solutions
	<ul style="list-style-type: none"><li data-bbox="476 249 1073 277">▶ Stop the vehicle in accordance with the traffic conditions.</li><li data-bbox="476 280 875 308">▶ Check the tire pressure and the tires.</li></ul>



**1, 2, 3 ...****4MATIC**

Function..... 153

**12 V battery**

see On-board electrical system battery (12 V)

**12 V socket**

see Socket (12 V)

**48 V on-board electrical system**

Operating safety..... 21

**115 V socket**

see Socket (115 V)

**360° Camera**

Function..... 201

**A****A/C function**

Activating/deactivating (control panel)... 128

Activating/deactivating (MBUX multi-media system)..... 129

**ABS (Anti-lock Braking System)..... 164****Acceleration**

see Kickdown

**Accident and Breakdown Management**

Mercedes me connect..... 252

**Acoustic locking verification signal**

Activating/deactivating..... 62

**Active Blind Spot Assist**

Brake application..... 193

Function..... 192

System limitations..... 192

**Active Brake Assist**

Function/notes..... 183

Setting..... 187

**Active Distance Assist DISTRONIC**

Active Emergency Stop Assist..... 181

Active Lane Change Assist..... 182

Calling up a speed..... 174

Function..... 172

Increasing/decreasing the speed..... 174

Route-based speed adaptation..... 177

Storing a speed..... 174

Switching off/deactivating..... 174

Switching on/activating..... 174

System limitations..... 172

**Active Emergency Stop Assist..... 181****Active headlamps..... 114****Active Lane Change Assist**

Activating/deactivating..... 183

Function..... 182

**Active Lane Keeping Assist**

Activating/deactivating..... 196

Activating/deactivating the warning..... 196

Function..... 194

Setting the sensitivity..... 196

System limits..... 194

**Active Parking Assist**

Automatic braking function..... 214

Exiting a parking space..... 213

Function..... 210

Parking..... 212

Pausing..... 214

System limitations..... 210

**Active Service System PLUS**

see ASSYST PLUS

**Active Speed Limit Assist**

Display..... 176

Function..... 176

**Active Steering Assist**

Activating/deactivating..... 181

Active Emergency Stop Assist..... 181

- Active Lane Change Assist..... 182  
 Function..... 179  
 System limits..... 179
- Active Traffic Jam Assist**  
 Activating/deactivating..... 179  
 Function..... 178
- Adaptive cruise control**  
 see Active Distance Assist DISTRONIC
- Adaptive Highbeam Assist**  
 Activating/deactivating..... 117  
 Function..... 116
- Adaptive Highbeam Assist Plus**  
 Function..... 117  
 Switching on/off..... 118
- Additives**  
 Engine oil..... 339  
 Fuel..... 339
- Additives (engine oil)**  
 see Additives
- Additives (fuel)**  
 see Fuel
- ADS PLUS damping system**  
 see AIR BODY CONTROL
- After-sales service**  
 see ASSYST PLUS
- Air bag**  
 Reduced protection..... 41
- AIR BODY CONTROL**  
 Setting..... 197  
 Suspension..... 196
- Air conditioning menu**  
 Calling up..... 128
- Air distribution**  
 Setting..... 127  
 Setting (MBUX multimedia system)..... 129
- Air freshener system**  
 see Fragrance system
- Air inlet**  
 see Air-water duct
- Air pressure**  
 see Tire pressure
- Air suspension**  
 see AIR BODY CONTROL
- Air vents**  
 Adjusting (front)..... 132  
 Adjusting (rear)..... 133
- Air vents**  
 see Air vents
- Air-conditioning system**  
 see Climate control
- Air-recirculation mode**..... 130
- Air-water duct**  
 Keeping free..... 274
- Airbag**  
 Activation..... 34  
 Automatic co-driver airbag shutoff..... 42  
 Front airbag (driver, front passenger)..... 39  
 Installation locations..... 39  
 Knee airbag..... 39  
 Overview..... 39  
 PASSENGER AIR BAG indicator lamps..... 43  
 Protection..... 40  
 Side airbag..... 39  
 Window curtain airbag..... 39
- Airflow**  
 Setting..... 127
- Alarm**  
 see Panic alarm
- Alarm system**  
 see ATA (anti-theft alarm system)

































- All-wheel drive**  
see 4MATIC
- Ambient lighting**  
Setting (MBUX multimedia system)..... 120
- Android Auto**  
see Smartphone integration
- Animals**  
Pets in the vehicle..... 60
- Anti-lock braking system**  
see ABS (Anti-lock Braking System)
- Anti-skid chains**  
see Snow chains
- Anti-theft protection**  
Immobilizer..... 80
- Anti-theft protection**  
see ATA (anti-theft alarm system)
- Anticipatory occupant protection**  
see PRE-SAFE® (anticipatory occupant protection)  
see PRE-SAFE® PLUS (anticipatory occupant protection plus)
- Apple CarPlay®**  
see Smartphone integration
- Assistance systems**  
see Driving safety system
- ASSYST PLUS**  
Battery disconnection periods..... 268  
Displaying the service due date..... 267  
Function/notes..... 267  
Regular maintenance work..... 267  
Special service requirements..... 267
- ATA (anti-theft alarm system)**  
Activating/deactivating the interior motion sensor..... 83  
Arming/disarming the tow-away alarm..... 82  
Deactivating the alarm..... 82  
Function..... 81  
Interior motion sensor function..... 82  
The tow-away alarm function..... 82
- ATTENTION ASSIST**  
Function..... 168  
Setting..... 170  
System limitations..... 168
- Attention assistant**  
see ATTENTION ASSIST
- Authorized Mercedes-Benz Center**  
see Qualified specialist workshop
- Authorized workshop**  
see Qualified specialist workshop
- Automatic co-driver airbag shutoff**  
Function of co-driver airbag shutoff..... 42
- Automatic distance control**  
see Active Distance Assist DISTRONIC
- Automatic driving lights**..... 112
- Automatic engine start**  
see ECO start/stop function
- Automatic engine stop**  
see ECO start/stop function
- Automatic front passenger airbag shutoff**  
PASSENGER AIR BAG indicator lamps..... 43
- Automatic mirror folding function**  
Activating/deactivating..... 126
- Automatic seat adjustment**  
Setting..... 89
- Automatic transmission**  
DIRECT SELECT lever..... 148  
Drive program display..... 147  
Drive programs..... 146  
DYNAMIC SELECT switch..... 146  
Engaging drive position..... 150

- Engaging reverse gear..... 149
  - Kickdown..... 152
  - Manual gearshifting..... 151
  - Selecting park position..... 150
  - Steering wheel paddle shifters..... 151
  - Transmission position display..... 148
  - Transmission positions..... 148
  - Automatic transmission (problem)**  
see Transmission (problem)
- B**
- Back seat**  
see Seats
  - Bad weather light**..... 115
  - Bag hook**..... 103
  - BAS (Brake Assist System)**..... 165
  - Battery (SmartKey)**  
Replacing..... 63
  - Battery (vehicle)**  
Charging (Remote Online)..... 136
  - Notes..... 288
  - Notes (starting assistance and charging)..... 290
  - Belt**  
see Seat belt
  - Blind Spot Assist**  
Activating/deactivating..... 194
  - Function..... 192
  - System limitations..... 192
  - Blower**  
see Climate control
  - Brake Assist System**  
see BAS (Brake Assist System)
  - Brake fluid**  
Notes..... 340
  - Brake force distribution**  
EBD (electronic brake force distribution)..... 167
  - Brakes**  
ABS (Anti-lock Braking System)..... 164
  - Active Brake Assist..... 183
  - BAS (Brake Assist System)..... 165
  - Breaking-in notes..... 137
  - Driving tips..... 139
  - EBD (electronic brake force distribution)..... 167
  - HOLD function..... 167
  - Limited braking effect (salt-treated roads)..... 139
  - New/replaced brake linings/brake discs..... 137
  - Braking assistance**  
see BAS (Brake Assist System)
  - Breakdown**  
Assistance overview..... 14
  - Changing a wheel..... 324
  - Roadside Assistance..... 20
  - Tow-starting..... 297
  - Towing away..... 294
  - Transporting the vehicle..... 295
  - Breakdown**  
see Flat tire
  - Breaking-in notes**..... 137
  - Buttons**  
Steering wheel..... 218
- C**
- Calls**  
Mercedes me..... 249





























- Camera**
  - Information..... 163
- Camera**
  - see 360° Camera
  - see Dashcam
  - see Rear view camera
- Car key**
  - see SmartKey
- Car wash**
  - see Care
- Car wash (care)..... 274**
- Car-to-X-Communication**
  - Displaying hazard warnings..... 242
- Care**
  - Air-water duct..... 274
  - Automatic car wash..... 274
  - Carpet..... 278
  - Decorative foil..... 276
  - Display..... 278
  - Exterior lighting..... 277
  - Head-up Display..... 278
  - Headliner..... 278
  - Paint..... 275
  - Plastic trim..... 278
  - Power washer..... 275
  - Real wood/trim elements..... 278
  - Rear view camera..... 277
  - Seat belt..... 278
  - Seat cover..... 278
  - Sensors..... 277
  - Steering wheel..... 278
  - Surround view camera..... 277
  - Tailpipes..... 277
  - Washing by hand..... 275
  - Wheels/rims..... 277
  - Windows..... 277
  - Wiper blades..... 277
- Cargo tie-down rings..... 102**
- Carpet (Care)..... 278**
- Change of address..... 20**
- Change of ownership..... 20**
- Changing a wheel**
  - Preparation..... 324
  - Raising the vehicle..... 326
- Changing a wheel**
  - see Emergency spare wheel
- Changing gears**
  - Manually..... 151
- Changing hub caps..... 325**
- Charging**
  - On-board electrical system battery (12 V)..... 291
  - USB port..... 107
- Chassis level (AIR BODY CONTROL)**
  - Setting..... 197
- Child safety lock**
  - Rear door..... 58
  - Rear side windows..... 59
- Child seat**
  - Attaching (notes)..... 51
  - Basic instructions..... 47
  - Front-passenger seat (notes)..... 56
  - LATCH-type (ISOFIX) (installing)..... 52
  - Notes on risks and dangers..... 48
  - Securing on the front passenger seat..... 57
  - Securing on the rear seat..... 55
  - Top Tether..... 54
- Children**
  - Avoiding dangers in the vehicle..... 48
  - Basic instructions..... 47
  - Special seat belt retractor..... 51

- Chock**  
Storage location..... 324
- Chock**  
see Chock
- City lighting**..... 115
- Cleaning**  
see Care
- Climate control**  
Activating/deactivating..... 128  
Activating/deactivating the A/C function (control panel)..... 128  
Activating/deactivating the A/C function (MBUX multimedia system)..... 129  
Activating/deactivating the synchronization function (control panel)..... 129  
Activating/deactivating the synchronization function (MBUX multimedia system)..... 130  
Air-recirculation mode..... 130  
Automatic control..... 129  
Calling up the air conditioning menu..... 128  
Climate style function..... 129  
Control panel for 3-zone automatic climate control..... 127  
Control panel for dual-zone automatic climate control..... 127  
Defrosting the windshield..... 127  
Filling capacity for PAG oil..... 343  
Front air vents..... 132  
Information on the windshield heater..... 132  
Inserting/removing the flacon (fragrance system)..... 131  
Ionization..... 130  
Note..... 127  
Rear air vents..... 133  
Refrigerant..... 342  
Refrigerant filling capacity..... 343  
Removing condensation from the windows..... 130  
Residual heat..... 130  
Setting (MBUX multimedia system)..... 128  
Setting the air distribution..... 127  
Setting the airflow..... 127  
Setting the climate style..... 129  
Setting the fragrance system..... 130  
Setting the vehicle interior temperature..... 127  
Switching the rear window heater on/off..... 127  
Ventilating the vehicle (convenience opening)..... 76
- Climate style**  
Function..... 129  
Setting..... 129
- Co-driver airbag shutoff**  
see Automatic co-driver airbag shutoff
- Cockpit**  
Overview..... 6
- Coffee cup symbol**  
see ATTENTION ASSIST
- Collision detection (parked vehicle)**  
Setting..... 161
- Combination switch**..... 112
- Component-specific information**..... 334
- Computer**  
see On-board computer
- Connecting the parcel net**..... 104
- Convenience closing**..... 76
- Convenience opening**..... 76
- Coolant (engine)**  
Capacity..... 341

- Level check..... 272
- Notes..... 340
- Cooling**
  - see Climate control
- Copyrights**
  - License..... 32
  - Trademarks..... 32
- Cornering light**..... 114
- Cross traffic (warning)**
  - see Maneuvering assistance
- Cross Traffic Alert**..... 215
- Crosswind Assist**
  - Function/notes..... 166
- Cruise control**
  - Activating..... 171
  - Buttons..... 171
  - Calling up a speed..... 171
  - Deactivating..... 171
  - Function..... 170
  - Requirements:..... 171
  - Selecting..... 171
  - Setting a speed..... 171
  - Storing a speed..... 171
  - System limitations..... 170
- Customer Assistance Center (CAC)**..... 26
- Customer Relations Department**..... 26
- D**
- Dashboard**
  - see Cockpit
- Dashcam**
  - Notes..... 244
  - Selecting a USB device..... 244
  - Starting/stopping a video recording..... 244
- Data acquisition**
  - Vehicle..... 27
- Data protection rights**
  - Data storage..... 30
- Data storage**
  - Data protection rights..... 30
  - Electronic control units..... 27
  - Online services..... 30
  - Vehicle..... 27
- Daytime running lamp mode**
  - see Daytime running lamps
- Daytime running lamps**
  - Activating/deactivating..... 119
- Deactivating the alarm (ATA)**..... 82
- Dealership**
  - see Qualified specialist workshop
- Declaration of conformity**
  - Wireless vehicle components..... 23
- Decorative foil (cleaning instructions)**..... 276
- Definitions (tires and loading)**..... 318
- Destination entry**
  - Entering a POI or address..... 239
- Detecting inattentiveness**
  - see ATTENTION ASSIST
- Diagnostics connection**..... 24
- Digital Operator's Manual**..... 16
- Dinghy towing**
  - see Tow-bar system
- DIRECT SELECT lever**
  - Engaging drive position..... 150
  - Engaging neutral..... 149
  - Engaging park position automatically..... 150
  - Engaging reverse gear..... 149
  - Function..... 148
  - Selecting park position..... 150

- Display (care)**..... 278
- Display (MBUX multimedia system)**
- Home screen..... 225
  - Operating..... 226
- Display (on-board computer)**
- Displays on the instrument display..... 220
- Display in the windshield**
- see Head-up Display
- Display message**
- Calling up (on-board computer)..... 345
  - Notes..... 345
- Display messages**
-  --- mph..... 371
  -  --- mph..... 371
  -  12 V Battery See Operator's Manual..... 387
  -  48 V Battery See Operator's Manual..... 389
  -  Active Headlamps Inoperative..... 352
  -  ATTENTION ASSIST Inoperative..... 370
  -  ATTENTION ASSIST: Take a Break!..... 371
  -  Automatic Headlamp Mode Inoperative..... 352
  -  Check Brake Fluid Level..... 369
  -  Check Coolant Level See Operator's Manual..... 359
  -  Check Engine Oil Level (Add 1 quart)..... 395
  -  Check Left Low Beam (example)... 351
  -  Check Tires..... 391
  -  Check Washer Fluid..... 358
  -  Coolant Too Hot Stop Vehicle Turn Engine Off..... 360
  -  Currently Unavailable See Operator's Manual..... 382
  -  Currently Unavailable See Operator's Manual..... 383
  -  Don't Forget Your Key..... 350
  -  Drive More Slowly..... 381
  -  Engine Oil Level Cannot Be Measured..... 396
  -  Engine Oil Level Low Stop Vehicle Turn Engine Off..... 395
  -  Engine Oil Pressure Stop Switch Off Engine..... 396
  -  Engine Oil Reduce Oil Level..... 395
  -  Front Left Malfunction Service Required (example)..... 346
  -  Fuel Level Low..... 361
  -  Gas Cap Loose..... 361
  -  Inoperative See Operator's Manual..... 383
  -  Inoperative See Operator's Manual..... 384
  -  Inoperative See Operator's Manual..... 385
  -  Inoperative..... 386
  -  Intell. Light System Inoperative..... 353
  -  Key Being Initialized Please Wait... 351



-  Key Not Detected (red display message)..... 350
-  Key Not Detected (white display message)..... 350
-  Left Side Curtain Airbag Malfunction Service Required (example)..... 346
-  Lowering..... 381
-  Malfunction Drive at Max. 50 mph..... 380
-  Malfunction See Operator's Manual..... 352
-  Obtain a New Key..... 349
-  Off..... 372
- HOLD** Off..... 370
- PARK** Parking Brake See Operator's Manual..... 365
-  Please Correct Tire Pressure..... 392
- PARK** Please Release Parking Brake..... 368
-  Please Wait Charging 48 V Battery..... 389
-  Rear Left Backrest Not Latched (example)..... 358
-  Replace Key Battery..... 349
-  See Operator's Manual..... 387
-  SRS Malfunction Service Required..... 346
-  Steering Malfunction Increased Physical Effort See Operator's Manual... 356
-  Steering Malfunction Stop Immediately See Operator's Manual..... 356
-  Stop Vehicle Leave Engine Running..... 388
-  Stop Vehicle See Operator's Manual..... 388
-  Stop Vehicle Vehicle Too Low..... 380
-  Suspended..... 372
-  Switch Off Lights..... 353
-  Switch On Headlamps..... 352
-  Temporarily Unavailable Camera View Restricted..... 379
-  Temporarily Unavailable Sensors are Dirty..... 378
- PARK** Turn On the Ignition to Release the Parking Brake..... 369
-  Vehicle Ready to Drive Switch the Ignition Off Before Exiting..... 355
-  Vehicle Rising Please Wait..... 381
-  Vehicle Rising..... 381
-  Warning Tire Malfunction..... 392
-  Wheel Sensor(s) Missing..... 391
- Active Blind Spot Assist Currently Unavailable See Operator's Manual..... 376
- Active Blind Spot Assist Inoperative..... 376
- Active Brake Assist Functions Currently Limited See Operator's Manual.... 385
- Active Brake Assist Functions Limited See Operator's Manual..... 386
- Active Distance Assist Currently Unavailable See Operator's Manual..... 372
- Active Distance Assist Inoperative..... 372

- Active Distance Assist Now Available..... 373
- Active Lane Keeping Assist Currently Unavailable See Operator's Manual..... 377
- Active Lane Keeping Assist Inoperative... 377
- Active Steering Assist Currently Unavailable See Operator's Manual..... 373
- Active Steering Assist Inoperative..... 373
- Active Steering Asst. Currently Unavailable Due to Multiple Emergency Stops..... 373
- Active Stop & Go Assist Currently Unavailable See Operator's Manual..... 374
- Active Stop & Go Assist Inoperative See Operator's Manual..... 375
- Adaptive Highbeam Assist Currently Unavailable See Operator's Manual..... 353
- Adaptive Highbeam Assist Inoperative.... 353
- Adaptive Highbeam Assist Plus Currently Unavailable See Operator's Manual..... 354
- Adaptive Highbeam Assist Plus Inoperative..... 354
- Apply Brake to Shift from 'P'..... 361
- Apply Brake to Shift to 'R'..... 362
- Apply Brake to Shift to D or R..... 362
- Auxiliary Battery Malfunction (red display message)..... 364
- Auxiliary Battery Malfunction (white display message)..... 363
- Beginning Emergency Stop..... 374
- Blind Spot Assist Currently Unavailable See Operator's Manual..... 375
- Blind Spot Assist Inoperative..... 376
- Cannot Start Engine See Operator's Manual..... 359, 389
- Check Brake Pads See Operator's Manual..... 370
- Check Tire Pressure Soon..... 393
- Check Tire Pressure Then Restart Run Flat Indicator..... 394
- Cruise Control Inoperative..... 371
- Cruise Control Off..... 371
- Decrease Speed..... 393
- Device Detected at Diagnostics Connection See Operator's Manual..... 387
- Driver's Door Open & Transmission Not in P Risk of Vehicle Rolling Away..... 362
- Engine Can Now Be Started..... 390
- Front Passenger Airbag Disabled See Operator's Manual..... 347
- Front Passenger Airbag Enabled See Operator's Manual..... 347
- Hazard Warning Flashers Malfunctioning..... 354
- Head-up Display Currently Unavailable See Operator's Manual..... 355
- Head-up Display Inoperative..... 355
- N Permanently Active Risk of Rolling Away..... 362

- Only Shift to 'P' when Vehicle is Stationary..... 361
- Parking Assist and PARKTRONIC Inoperative See Operator's Manual..... 382
- Place the Key in the Marked Space See Operator's Manual..... 351
- PRE-SAFE Impulse Side Inoperative See Operator's Manual..... 349
- PRE-SAFE Inoperative See Operator's Manual..... 348
- Reversing Not Possible Service Required..... 363
- Run Flat Indicator Inoperative..... 394
- Service Required Do Not Shift Gears Visit Dealer..... 363
- Stop Vehicle Leave Engine Running Wait Transmission Cooling..... 363
- Tire Press. Monitor Currently Unavailable..... 390
- Tire Press. Monitor Inoperative..... 390
- Tire Pressure Monitor Inoperative No Wheel Sensors..... 391
- Tires Overheated..... 393
- To Deselect P or N, Depress Brake and Start Engine..... 362
- To switch engine off, press and hold Start/Stop button for at least 3 seconds or press 3 times..... 359
- Traffic Sign Assist Currently Unavailable See Operator's Manual..... 375
- Traffic Sign Assist Inoperative..... 375
- Transmission Malfunction Stop..... 363
- Wiper Malfunctioning..... 358
- Distance control**  
see Active Distance Assist DISTRONIC
- DISTRONIC**  
see Active Distance Assist DISTRONIC
- Door**  
Child safety lock (rear door)..... 58  
Locking/unlocking (emergency key)..... 68  
Opening (from inside)..... 65
- Power closing function..... 67  
Unlocking (from inside)..... 65
- Door control panel**..... 12
- DOT, Tire Identification Number (TIN)**..... 314
- Drawbar**  
see Tow-bar system
- Drinking and driving**..... 139
- Drive Away Assist**..... 214
- Drive position**  
Inserting..... 150
- Drive program display**..... 147
- Drive programs**  
see DYNAMIC SELECT
- Driver's seat**  
see Seat
- Driving safety system**  
ABS (Anti-lock Braking System)..... 164  
Active Brake Assist..... 183  
BAS (Brake Assist System)..... 165  
Cameras..... 163  
EBD (electronic brake force distribution)..... 167  
ESP® Crosswind Assist..... 166

- Overview..... 163
- Radar and ultrasonic sensors..... 163
- Responsibility..... 162
- STEER CONTROL..... 167
- Driving system**
- DYNAMIC BODY CONTROL..... 196
- Driving system**
- see 360° Camera
- see Active Blind Spot Assist
- see Active Distance Assist DISTRONIC
- see Active Emergency Stop Assist
- see Active Lane Change Assist
- see Active Lane Keeping Assist
- see Active Parking Assist
- see Active Speed Limit Assist
- see Active Steering Assist
- see AIR BODY CONTROL
- see ATTENTION ASSIST
- see Blind Spot Assist
- see Cruise control
- see Driving safety system
- see HOLD function
- see Parking Assist PARKTRONIC
- see Rear view camera
- see Traffic Sign Assist
- Driving tips**
- Breaking-in notes..... 137
- Drinking and driving..... 139
- General driving tips..... 139
- Optimized acceleration..... 138
- Drowsiness detection**
- see ATTENTION ASSIST
- DYNAMIC BODY CONTROL**
- Suspension..... 196
- Dynamic handling control system**
- see ESP® (Electronic Stability Program)
- DYNAMIC SELECT**
- Calling up the fuel consumption indi-  
  cator..... 148
- Configuring drive program I..... 147
- Displaying engine data..... 148
- Displaying vehicle data..... 148
- Drive program display..... 147
- Drive programs..... 146
- Function..... 146
- Operating (DYNAMIC SELECT switch)..... 147
- Selecting the drive program..... 147

## E

- E10**..... 338
- Easy entry feature**
- Function/notes..... 94
- Setting..... 95
- Easy exit feature**
- Function/notes..... 94
- Setting..... 95
- EBD (electronic brake force distribution)**
- Function/notes..... 167
- ECO Assist**
- Function/notes..... 144
- ECO display**
- Function..... 144
- ECO start/stop function**
- Switching off/on..... 143
- Electric parking brake**
- Applying automatically..... 159
- Applying/releasing manually..... 160
- Emergency braking..... 161
- Releasing automatically..... 160
- Electronic Stability Program**
- see ESP® (Electronic Stability Program)

- Emergency**  
 Assistance overview..... 14  
 First-aid kit (soft sided)..... 282  
 Reflective safety vest..... 281  
 Removing the warning triangle..... 281  
 Setting up the warning triangle..... 282
- Emergency braking**..... 161
- Emergency braking**  
 see BAS (Brake Assist System)
- Emergency call**  
 see Mercedes-Benz emergency call system
- Emergency key**  
 Locking/unlocking the doors..... 68
- Emergency operation mode**  
 Starting the vehicle..... 136
- Emergency release**  
 Trunk lid (from inside)..... 74
- Emergency spare wheel**  
 Notes..... 330
- Emergency Tensioning Devices**  
 Activation..... 34
- Engine**  
 Engine number..... 335  
 Starting (emergency operation mode).... 136  
 Starting (Remote Online)..... 137
- Engine data**  
 Displaying..... 148
- Engine number**..... 335
- Engine oil**  
 Additives..... 339  
 Capacity..... 340  
 Checking the oil level using the on-board computer..... 270  
 MB-Freigabe or MB-Approval..... 340  
 Quality..... 340  
 Refilling..... 271
- Error message**  
 see Display message
- ESC (Electronic Stability Control)**  
 see ESP® (Electronic Stability Program)
- ESP®**  
 Crosswind Assist..... 166
- ESP® (Electronic Stability Program)**  
 Activating/deactivating..... 166  
 Function/notes..... 165
- Exterior lighting**  
 Care..... 277
- Exterior lighting**  
 see Lights
- Exterior mirrors**  
 Automatic mirror folding function..... 126  
 Parking position..... 125
- F**
- Fatigue detection**  
 see ATTENTION ASSIST
- First-aid kit (soft sided)**..... 282
- Flacon**  
 Inserting/removing..... 131
- Flat tire**  
 Changing a wheel..... 324  
 MOExtended tires..... 283  
 Notes..... 282  
 TIREFIT kit..... 284
- Flat towing**  
 see Tow-bar system
- Floor mats**..... 109
- Fog light (enhanced)**..... 115

<b>Foil covering</b>	
Radar and ultrasonic sensors.....	163
<b>Fragrance</b>	
see Fragrance system	
<b>Fragrance system</b>	
Inserting/removing the flacon.....	131
<b>Free software</b> .....	32
<b>Frequencies</b>	
Two-way radio.....	333
<b>Front airbag (driver, front passenger)</b> .....	39
<b>Front passenger seat</b>	
see Seat	
<b>Fuel</b>	
Additives.....	339
E10.....	338
Fuel reserve.....	339
Gasoline.....	338
Quality (gasoline).....	338
Refueling.....	153
Sulfur content.....	338
Tank content.....	339
<b>Fuel consumption indicator</b>	
Calling up.....	148

<b>Function seat</b>	
see Door control panel	
<b>Fuses</b>	
Before replacing a fuse.....	297
Dashboard fuse box.....	299
Fuse assignment diagram.....	297
Fuse box in the engine compartment.....	298
Fuse box in the front-passenger foot-well.....	299
Fuse box in the trunk.....	300
Notes.....	297

<b>Fuses</b>	
see Fuses	

<b>G</b>	
<b>Garage door opener</b>	
Clearing the memory.....	159
<b>Garage door openers</b>	
Opening/closing the door.....	159
Programming buttons.....	157
Resolving problems.....	158
Synchronizing the rolling code.....	158
<b>Gasoline</b> .....	338
<b>Gearshift recommendation</b> .....	151

<b>Genuine parts</b> .....	18
<b>Glide mode</b> .....	152

**H**

<b>Handbrake</b>	
see Electric parking brake	
<b>Handling (unusual)</b> .....	301
<b>HANDS-FREE ACCESS</b> .....	72
<b>Hazard warning lights</b> .....	113
<b>Hazardous substances</b>	
Information.....	21
<b>Head restraint</b>	
Front (adjusting mechanically).....	87
Rear (adjusting).....	88
<b>Head-up Display</b>	
Adjusting brightness (on-board computer).....	221
Adjusting display elements (on-board computer).....	221
Care.....	278
Function.....	220
Menu (on-board computer).....	221
Operating the memory function.....	96

- Setting the position (on-board computer)..... 221  
Switching on/off..... 222
- Headlamps**  
see Automatic driving lights
- Headliner (care)**..... 278
- Heating**  
see Climate control
- Help call**  
see Mercedes-Benz emergency call system
- High beam**  
Activating/deactivating..... 112
- High beam**  
see Adaptive Highbeam Assist  
see Adaptive Highbeam Assist Plus
- High-beam flasher**..... 112
- Highway mode**..... 115
- Hill start assist**..... 168
- HOLD function**  
Function/notes..... 167  
Switching on/off..... 167
- Home screen (media display)**  
Overview..... 225
- Hood**  
Opening/closing..... 268
- I**
- Identification plate**  
Engine..... 335  
Refrigerant..... 342  
Vehicle..... 335
- Ignition key**  
see SmartKey
- Immobilizer**..... 80
- Indicator lamp**  
see Warning/indicator lamp
- Individual drive program**  
Configuring..... 147  
Selecting..... 147
- Inside rearview mirror**  
Anti-glare mode (automatic)..... 124
- Inside rearview mirror**  
see Outside mirrors
- Inspection**  
see ASSYST PLUS
- Instrument cluster**  
Function/notes..... 216, 217
- Instrument display**  
Function/notes..... 217  
Instrument cluster..... 8  
Overview of displays..... 220  
Warning/indicator lamps..... 397
- Instrument display and on-board computer**  
Function/notes..... 216
- Intelligent Light System**  
Activating/deactivating..... 115  
Active headlamps..... 114  
Adaptive Highbeam Assist..... 116  
Adaptive Highbeam Assist Plus..... 117  
Bad weather light..... 115  
City lighting..... 115  
Cornering light..... 114  
Fog light (enhanced)..... 115  
Highway mode..... 115  
Overview..... 114

**Interior lighting**

- Adjusting..... 119
- Ambient lighting..... 120
- Reading lamp..... 119
- Switch-off delay time..... 120

**Interior motion sensor**

- Activating/deactivating..... 83
- Function..... 82

**Internet radio**

see TuneIn

**Ionization**

- Activating/deactivating (MBUX multi-media system)..... 130

**iPhone®**

see Smartphone integration

**J****Jack**

- Storage location..... 324

**Jump-start connection**

- General notes..... 290

**K****KEYLESS-GO**

- Deactivating a function..... 62
- Locking/unlocking the vehicle..... 65
- Problem..... 66
- Unlocking setting..... 62

**Kickdown**

- Using..... 152

**Knee airbag**..... 39**L****Labeling (tires)**

see Tire labeling

**Lamp**

see Interior lighting

**Lamp (instrument display)**

see Warning/indicator lamp

**Lane detection (automatic)**

see Active Lane Keeping Assist

**Lane Keeping Assist**

see Active Lane Keeping Assist

**Language**

- Notes..... 236

- Setting..... 236

**LATCH-type (ISOFIX) child seat anchor**

- Installing..... 52

**Level control system**

see AIR BODY CONTROL

**Light switch**

- Overview..... 111

**Lighting**

see Interior lighting

see Lights

**Lights**

- Active headlamps..... 114
- Adaptive Highbeam Assist..... 116
- Adaptive Highbeam Assist Plus..... 117
- Automatic driving lights..... 112
- Bad weather light..... 115
- City lighting..... 115
- Combination switch..... 112
- Cornering light..... 114
- Fog light (enhanced)..... 115
- Hazard warning lights..... 113
- High beam..... 112
- High-beam flasher..... 112
- Highway mode..... 115



- Intelligent Light System..... 114  
 Light switch..... 111  
 Low beam..... 111  
 Parking lights..... 111  
 Rear fog light..... 111  
 Responsibility for lighting systems..... 111  
 Setting the exterior lighting switch-off delay time..... 119  
 Standing lights..... 111  
 Switching the Intelligent Light System on/off..... 115  
 Switching the surround lighting on/off... 119  
 Turn signal light..... 112
- Limited Warranty**  
 Vehicle..... 27
- Live Traffic Information**  
 Switching the traffic information display on..... 242
- Load index (tires)**..... 316
- Load-bearing capacity (tires)**..... 316
- Loading**  
 Bag hook..... 103  
 Cargo tie-down rings..... 102  
 Definitions..... 318
- Notes..... 97  
 Roof luggage rack..... 104
- Loading guidelines**..... 97
- Loading information table**..... 308
- Loads**  
 Fixing..... 97
- Locking/unlocking**  
 Emergency key..... 68  
 KEYLESS-GO..... 65  
 Switching the automatic locking feature on/off..... 67  
 Unlocking/opening the doors from the inside..... 65
- Low beam**  
 Activating/deactivating..... 111
- Lubricant additives**  
 see Additives
- Luggage**  
 Parcel net..... 104  
 Securing..... 97
- Lumbar support**  
 see Lumbar support (4-way)
- Lumbar support (4-way)**..... 84
- M**
- Maintenance**  
 Vehicle..... 20
- Maintenance**  
 see ASSYST PLUS
- Malfunction**  
 Restraint system..... 34
- Maneuvering aid**  
 see Maneuvering assistance
- Maneuvering assistance**  
 Activating/deactivating..... 215  
 Cross Traffic Alert..... 215  
 Drive Away Assist..... 214
- Map**  
 Displaying online map contents..... 242  
 Displaying weather information..... 242  
 Moving..... 241  
 Selecting the map orientation..... 241  
 Setting the map scale..... 241  
 Switching freeway information on/off.... 241
- Massage program**  
 Overview..... 90

- Massage programs**  
Resetting the settings..... 90  
Selecting the front seats..... 90
- Maximum load rating**..... 315
- Maximum permissible load**  
Calculation example..... 310  
Determining..... 309
- Maximum tire pressure**..... 315
- MBUX Interior Assistant**  
Overview..... 228  
Switching the reading light on/off (contactless)..... 230  
Switching the search light on/off (contactless)..... 230
- MBUX multimedia system**  
Activating/deactivating standby mode... 162  
Configuring drive program I..... 147  
Home screen..... 225  
Notes..... 223  
Operating the touchscreen..... 226  
Overview..... 223  
Restoring (factory settings)..... 236  
Setting collision detection (parked vehicle)..... 161  
Setting route-based speed adaptation.... 178  
Setting the air distribution..... 129  
Setting the fragrance system..... 130  
Standby mode function..... 162  
Switching ionization on/off..... 130
- MBUX multimedia system**  
see Display (MBUX multimedia system)  
see MBUX Interior Assistant
- Mechanical key**  
Inserting/removing..... 63
- Media**  
Overview of the functions and symbols... 259
- Media mode**  
Connecting Bluetooth® audio equipment..... 260
- Medical aids**..... 25
- Memory function**  
Function..... 95  
Head-up Display..... 96  
Operating..... 96  
Outside mirrors..... 96  
Seat..... 96  
Steering wheel..... 96
- Menu (on-board computer)**  
Head-up Display..... 221  
Overview..... 218
- Mercedes me app**  
Information..... 253
- Mercedes me calls**  
Arranging a service appointment..... 250  
Calling the Mercedes-Benz customer center..... 249  
Calling the Mercedes-Benz Customer Center after automatic accident or breakdown detection..... 250  
Information..... 249  
Making a call via the overhead control panel..... 249  
Transferred data..... 251
- Mercedes me connect**  
Accident and Breakdown Management... 252  
Information..... 252  
Transferred data..... 253
- Mercedes-AMG vehicles**  
Notes..... 134
- Mercedes-Benz emergency call system**  
Automatic emergency call..... 257

- Information..... 256
  - Information about data transfer..... 258
  - Manual emergency call..... 257
  - Overview..... 256
  - Message (instrument display)**
    - see Display message
  - Message memory**..... 345
  - Mirrors**
    - see Outside mirrors
  - Mobile phone**
    - Notes on wireless charging..... 107
  - Mobile phone**
    - see Smartphone integration
    - see Telephone
  - Model type**
    - see Vehicle identification plate
  - MOExtended tires**..... 283
  - MULTIBEAM LED**..... 114
  - Multifunction steering wheel**
    - Overview of buttons..... 218
  - Multifunction steering wheel**
    - see Steering wheel
  - Multimedia system**
    - see MBUX multimedia system
- N**
- Navigation**
    - Notes..... 237
    - Overview..... 238
    - Showing/hiding the menu..... 237
    - Switching on..... 237
  - Navigation**
    - see Destination entry
    - see Map
    - see Route
  - Neutral**
    - Engaging..... 149
- O**
- Occupant safety**
    - see Airbag
    - see Automatic co-driver airbag shutoff
    - see Child seat
    - see Pets in the vehicle
    - see PRE-SAFE® (anticipatory occupant protection)
  - see PRE-SAFE® Impulse Side
  - see PRE-SAFE® PLUS (anticipatory occupant protection plus)
  - see Restraint system
  - see Seat belt
  - Oil**
    - see Engine oil
  - On-board computer**
    - Displaying the service due date..... 267
    - Head-up Display menu..... 221
    - Instrument display..... 220
    - Menu overview..... 218
    - Operating..... 218
  - On-board diagnostics interface**
    - see Diagnostics connection
  - On-board electrical system battery (12 V)**
    - Charging..... 291
    - Replacing..... 292
    - Starting assistance..... 291
  - On-board electronics**
    - Notes..... 332
    - Two-way radios..... 332
  - Online services**
    - Data storage..... 30

- Open-source software**..... 32
- Opening the trunk lid using your foot**  
HANDS-FREE ACCESS..... 72
- Operating fluids**  
Additives (fuel)..... 339  
Brake fluid..... 340  
Coolant (engine)..... 340  
Engine oil..... 339  
Fuel (gasoline)..... 338  
Notes..... 336  
Refrigerant (air conditioning system)..... 342  
Windshield washer fluid..... 341
- Operating safety**  
48 V on-board electrical system..... 21  
Declaration of conformity (wireless  
vehicle components)..... 23  
Information..... 21
- Operating system**  
see On-board computer
- Operator's Manual**  
Vehicle equipment..... 19
- Operator's Manual (digital)**..... 16
- Optimized acceleration**  
Activating..... 138
- Outside mirrors**  
Anti-glare mode (automatic)..... 124  
Folding in/out..... 123  
Operating the memory function..... 96  
Setting..... 123
- Overhead control panel**  
Overview..... 10
- P**
- Paint (cleaning instructions)**..... 275
- Paint code**..... 335
- Panel heating**  
Setting..... 92
- Panic alarm**  
Arming/disarming..... 62
- Park position**  
Engaging..... 150  
Selecting automatically..... 150
- Parking**  
see Electric parking brake
- Parking aid**  
see Parking Assist PARKTRONIC
- Parking Assist PARKTRONIC**  
Activating..... 209  
Adjusting warning tones..... 210  
Function..... 204  
Side impact protection..... 207  
Switching off..... 209  
System limitations..... 204
- Parking assistance systems**  
see Active Parking Assist
- Parking brake**  
see Electric parking brake
- Parking for an extended period**..... 161
- Parking lights**..... 111
- Parking option**  
Selecting..... 242
- Parking position**  
Exterior mirrors..... 125  
Storing the position of the front-  
passenger outside mirror using  
reverse gear..... 125
- Parking service**  
Selecting parking options..... 242

- PASSENGER AIR BAG status display**  
see Automatic front passenger airbag shutoff
- Payload**  
Calculation example..... 310  
Determining the maximum..... 309
- Perfume**  
see Fragrance system
- Perfume atomizer**  
Setting..... 130
- Perfume vial**  
see Fragrance system
- Period out of use**  
Activating/deactivating standby mode... 162  
Standby mode function..... 162
- Permissible towing methods**..... 293
- Pets in the vehicle**..... 60
- Plastic trim (Care)**..... 278
- Power closing function**  
Door..... 67
- Power supply**  
Switching on (start/stop button)..... 134
- Power washer (care)**..... 275
- PRE-SAFE® (anticipatory occupant protection)**  
Function..... 46  
PRE-SAFE® Sound..... 46  
Reversing measures..... 46
- PRE-SAFE® Impulse Side**  
Activation..... 34  
Function..... 47
- PRE-SAFE® PLUS (anticipatory occupant protection plus)**  
Function..... 46  
Reversing measures..... 46
- Preventative occupant protection system**  
see PRE-SAFE® (anticipatory occupant protection)  
see PRE-SAFE® PLUS (anticipatory occupant protection plus)
- Profile**  
Creating a new profile..... 232  
Notes..... 231  
Selecting profile options..... 232
- Programs**  
see DYNAMIC SELECT
- Protecting the environment**  
Notes..... 18
- Pulling away**  
see Driving tips
- Q**
- QR code**  
Rescue card..... 27
- Qualified specialist workshop**..... 25
- R**
- Radar and ultrasonic sensors**  
Damage..... 163
- Radio**  
Overview of the functions and symbols... 261
- Reading lamp**  
see Interior lighting
- Reading light**  
Switching on/off (contactless)..... 230
- Real wood (Care)**..... 278
- Rear door (child safety lock)**..... 58

- Rear fog lamp**  
Switching on/off..... 112
- Rear seat**  
see Seats
- Rear view camera**  
Care..... 277  
Function..... 199  
Opening the camera cover (surround view camera)..... 204
- Rear window**  
Roller sunblind..... 80
- Rear window heater**..... 127
- Reflective safety vest**..... 281
- Refrigerant (air conditioning system)**  
Notes..... 342
- Refueling**  
Refueling the vehicle..... 153
- Regulatory radio identification**  
Indonesia..... 334  
Small components..... 334
- Regulatory radio information**  
Installation clearances..... 334
- Remote Online**  
Charging the starter battery..... 136  
Cooling/heating the vehicle interior..... 136  
Starting the vehicle..... 137
- Reporting safety defects**..... 26
- Rescue card**..... 27
- Reserve**  
Fuel..... 339
- Reset function (MBUX multimedia system)**.... 236
- Residual heat**..... 130
- Restoring (factory settings)**  
see Reset function (MBUX multimedia system)
- Restraint system**  
Basic instructions for children..... 47  
Function in an accident..... 34  
Functionality..... 33  
Malfunction..... 34  
Protection..... 33  
Reduced protection..... 33  
Self-test..... 33  
Warning lamp..... 33
- Reverse gear**  
Engaging..... 149
- Rims (care)**..... 277
- Roadside Assistance (breakdown)**..... 20
- Roll away protection**  
see HOLD function
- Roller sunblind**  
Rear window..... 80
- Roof load**..... 344
- Roof luggage rack**  
Loading..... 104  
Securing..... 104
- Route**  
Calculating..... 240  
Selecting options..... 240
- Route guidance with augmented reality**  
Activating..... 240  
Displaying street names and house numbers..... 240
- Route-based speed adaptation**  
Function..... 177  
Setting..... 178
- Run-flat characteristics**  
MOExtended tires..... 283

## S

- Safety systems**
  - see Driving safety system
- Satellite radio**
  - Logging in..... 265
  - Setting music and sport alerts..... 265
- Search light**
  - Switching on/off (contactless)..... 230
- Seat**
  - 4-way lumbar support..... 84
  - Adjusting (electrically)..... 87
  - Adjusting (Seat Comfort)..... 84
  - Automatic adjustment..... 89
  - Configuring settings..... 89
  - Correct driver's seat position..... 84
  - Folding back the backrest (rear passenger compartment)..... 101
  - Locking the backrest (rear passenger compartment)..... 102
  - Massage program overview..... 90
  - Operating the memory function..... 96
  - Panel heating..... 92
  - Resetting the settings..... 90
  - Setting options..... 12
  - Workout program overview..... 90
- Seat belt**
  - Adjusting the height..... 38
  - Care..... 278
  - Fastening..... 38
  - Protection..... 35
  - Warning lamp..... 39
- Seat belt adjustment**
  - Activating/deactivating..... 38
  - Function..... 38
- Seat belt warning**
  - see Seat belt
- Seat belts**
  - Activating/deactivating seat belt adjustment..... 38
  - Reduced protection..... 36
  - Releasing..... 39
  - Seat belt adjustment (function)..... 38
- Seat cover (Care)..... 278**
- Seat heating**
  - Activating/deactivating..... 91
- Seat ventilation**
  - Activating/deactivating..... 92
- Seats**
  - Folding the backrest forwards (rear passenger compartment)..... 100
- Selecting a gear**
  - see Changing gears
- Selector lever**
  - see DIRECT SELECT lever
- Self-test**
  - Automatic front passenger airbag shut off..... 43
- Sensors (care)..... 277**
- Service**
  - see ASSYST PLUS
- Service Center**
  - see Qualified specialist workshop
- Service interval display**
  - see ASSYST PLUS
- Setting a speed**
  - see Cruise control
- Setting the map scale**
  - see Map
- Shift paddles**
  - see Steering wheel paddle shifters

- Shifting gears**  
Gearshift recommendation..... 151
- Side airbag**..... 39
- Side impact protection**..... 207
- Side windows**  
Child safety lock in the rear  
passenger compartment..... 59  
Closing using the SmartKey..... 76  
Convenience closing..... 76  
Convenience opening..... 76  
Opening with the SmartKey..... 76  
Opening/closing..... 74  
Problem..... 77
- Size designation (tires)**..... 316
- Sliding sunroof**  
Closing..... 77  
Closing using the SmartKey..... 76  
Opening..... 77  
Opening with the SmartKey..... 76  
Problem..... 79
- SmartKey**  
Acoustic locking verification signal..... 62  
Battery..... 63  
Deactivating a function..... 62  
Energy consumption..... 62  
Function overview..... 61  
Key ring attachment..... 63  
Mechanical key..... 63  
Panic alarm..... 62  
Problem..... 64  
Unlocking setting..... 62
- SmartKey**  
see SmartKey
- Smartphone**  
see Smartphone integration  
see Telephone
- Smartphone integration**  
Overview..... 254
- Snow chains**..... 302
- Socket (12 V)**  
Front center console..... 106
- Socket (115 V)**  
Rear passenger compartment..... 106
- Software update**  
System updates..... 233
- Sound**  
PRE-SAFE® Sound..... 46  
Wheels and tires..... 301  
Wheels/tires..... 301
- Sound menu**  
Functions overview..... 266
- Spare wheel**  
see Emergency spare wheel
- Special seat belt retractor**..... 51
- Specialist workshop**  
see Qualified specialist workshop
- Speed index (tires)**..... 316
- Standby mode**  
Activating/deactivating..... 162  
Function..... 162
- Standing lights**..... 111
- Start-off assist**  
see Optimized acceleration
- Start/stop button**  
Parking the vehicle..... 155  
Starting the vehicle..... 135  
Switching on the power supply/vehicle.. 134
- Start/stop function**  
see ECO start/stop function



- Starter battery**  
Charging (Remote Online)..... 136
- Starting**  
see Vehicle
- Starting assistance**  
see Jump-start connection
- Starting-off aid**  
see Hill start assist
- STEER CONTROL**  
Function/notes..... 167
- Steering wheel**  
Adjusting (electrically)..... 93  
Adjusting (manually)..... 92  
Buttons..... 218  
Care..... 278  
Operating the memory function..... 96  
Steering wheel heater..... 94
- Steering wheel heater**  
Activating/deactivating..... 94
- Steering wheel paddle shifters**..... 151
- Storage areas**  
see Storage space
- Storage compartments**  
see Storage space
- Storage space**  
Armrest..... 100  
Center console..... 100  
Door..... 100  
Glove box..... 100
- Stowage areas**  
see Loading
- Stowage compartments**  
see Loading
- Street names and house numbers**  
Displaying..... 240
- Suggestions**  
Configuring..... 232
- Sulfur content**..... 338
- Surround lighting**  
Switching on/off..... 119
- Surround View**  
see 360° Camera
- Surround view camera**  
Care..... 277
- Opening the camera cover (rear view camera)..... 204  
Selecting a view..... 204
- Suspension**  
Adjusting the chassis level (AIR BODY CONTROL)..... 197  
Damping characteristics..... 196  
DYNAMIC BODY CONTROL..... 196
- Suspension**  
see AIR BODY CONTROL
- Switch-off delay time**  
Exterior..... 119  
Interior..... 120
- Switching on the ignition**  
see Vehicle
- Synchronization function**  
Activating/deactivating (control panel)... 129  
Activating/deactivating (MBUX multimedia system)..... 130
- System settings**  
Overview of the system settings menu.... 232  
Reset function (MBUX multimedia system)..... 236

**System settings**

see Language

**T**

- Tailpipes (care)**..... 277
- Tank content**
- Fuel..... 339
  - Reserve (fuel)..... 339
- Technical data**
- Component-specific information..... 334
  - Information..... 332
  - Regulatory radio identification (Indonesia)..... 334
  - Regulatory radio identification of small components..... 334
  - Regulatory radio information..... 334
- Telephone**
- Connecting a mobile phone (Passkey).... 248
  - Connecting a mobile phone (Secure Simple Pairing)..... 248
  - Functions in the telephone menu..... 248
  - Notes..... 245
  - Notes on wireless charging (mobile phone)..... 107
  - Operating modes..... 247
  - Telephone menu overview..... 247
  - Wireless charging (mobile phone)..... 109
- Telephony operating modes**
- Bluetooth® Telephony..... 247
- Temperature**
- Setting the vehicle interior temperature..... 127
- Temperature grade**..... 313
- Themes**
- Fastening..... 232
- Through-loading feature**  
see Seats
- TIN (Tire Identification Number)**..... 314
- Tire and Loading Information placard**..... 308
- Tire characteristics**..... 316
- Tire inflation compressor**  
see TIREFIT kit
- Tire information table**..... 308
- Tire labeling**
- Characteristics..... 316
  - DOT, Tire Identification Number (TIN)..... 314
  - Load index..... 316
  - Load-bearing capacity..... 316
  - Maximum tire load..... 315
  - Maximum tire pressure..... 315
  - Overview..... 313
  - Speed rating..... 316
  - Temperature grade..... 313
  - Tire Quality Grading..... 313
  - Tire size designation..... 316
  - Traction grade..... 313
  - Tread wear grade..... 313
- Tire load (maximum)**..... 315
- Tire pressure**
- Checking (manually)..... 305
  - Checking (tire pressure monitoring system)..... 306
  - Maximum..... 315
  - Notes..... 302
  - Restarting the tire pressure loss warning system..... 308
  - Restarting the tire pressure monitoring system..... 307
  - Tire pressure loss warning system (function)..... 307

- Tire pressure monitoring system (function)..... 305
- Tire pressure table..... 304
- TIREFIT kit..... 284
- Tire pressure loss warning system**
  - Function..... 307
  - Restarting..... 308
- Tire pressure monitor**
  - Checking the tire pressure..... 306
  - Checking the tire temperature..... 306
  - Function..... 305
  - Restarting..... 307
- Tire pressure table**..... 304
- Tire Quality Grading**..... 313
- Tire temperature**
  - Checking (tire pressure monitoring system)..... 306
  - Tire pressure monitoring system (function)..... 305
- Tire tread**..... 301
- Tire-change tool kit**
  - Overview..... 324
- TIREFIT kit**
  - Storage location..... 284
  - Using..... 284
- Tires**
  - Characteristics..... 316
  - Checking..... 301
  - Checking the tire pressure (manually)..... 305
  - Checking the tire pressure (tire pressure monitoring system)..... 306
  - Definitions..... 318
  - DOT, Tire Identification Number (TIN)..... 314
  - Flat tire..... 282
  - Installing..... 328
  - Load index..... 316
  - Load-bearing capacity..... 316
  - Maximum tire load..... 315
  - Maximum tire pressure..... 315
  - MOExtended tires..... 283
  - Noise generation..... 301
  - Notes on installing..... 320
  - Overview of tire labeling..... 313
  - Removing..... 328
  - Replacing..... 320, 324
  - Replacing the wheel trim..... 325
  - Restarting the tire pressure loss warning system..... 308
  - Restarting the tire pressure monitoring system..... 307
  - Rotating..... 323
  - Selection..... 320
  - Snow chains..... 302
  - Speed rating..... 316
  - Storing..... 324
  - Temperature grade..... 313
  - Tire and Loading Information placard..... 308
  - Tire pressure (notes)..... 302
  - Tire pressure loss warning system (function)..... 307
  - Tire pressure monitoring system (function)..... 305
  - Tire pressure table..... 304
  - Tire Quality Grading..... 313
  - Tire size designation..... 316
  - TIREFIT kit..... 284
  - Traction grade..... 313
  - Tread wear grade..... 313
  - Unfamiliar handling..... 301
- Toll system**
  - Windshield..... 126

- Tool**  
see Vehicle tool kit
- Top Tether**..... 54
- Touch Control**  
On-board computer..... 218  
Operating..... 226
- Touchpad**  
Operating..... 226
- Touchscreen**  
Operating..... 226
- Tow-away alarm**  
Activating/deactivating..... 82  
Function..... 82
- Tow-bar system**..... 215
- Tow-starting**..... 297
- Towing away**..... 294
- Towing eye**  
Installing..... 297  
Storage location..... 296
- Towing methods**..... 293
- Traction grade**..... 313
- Traffic information**  
Switching on the display..... 242
- Traffic light data service**  
Display in the Instrument Display..... 189  
Turning the display on/off..... 191
- Traffic Sign Assist**  
Function/notes..... 188  
Setting..... 189  
System limits..... 188
- Transmission**  
Engaging neutral..... 149
- Transmission (problem)**..... 150
- Transmission position display**..... 148
- Transporting**  
Vehicle..... 295
- Tread wear grade**..... 313
- Trim element (Care)**..... 278
- Trunk lid**  
Closing..... 69  
Emergency release (from inside)..... 74  
HANDS-FREE ACCESS..... 72  
Locking separately..... 73  
Opening..... 68
- Opening dimensions..... 343
- Tuneln**  
Calling up..... 264
- Turn signal indicator**..... 112
- Turn signal light**  
Activating/deactivating..... 112
- Two-way radios**  
Frequencies..... 333  
Notes on installation..... 332  
Transmission output (maximum)..... 333
- U**
- Unlocking**  
see Locking/unlocking
- Updates**  
Important system updates..... 233
- USB port**  
Front storage compartment..... 100  
Rear passenger compartment..... 107
- V**
- Vehicle**  
Activating/deactivating standby mode... 162

- Collision detection (parked vehicle)..... 161
- Correct use..... 25
- Data acquisition..... 27
- Data storage..... 27
- Diagnostics connection..... 24
- Equipment..... 19
- Limited Warranty..... 27
- Locking (automatically)..... 67
- Locking/unlocking (emergency key)..... 68
- Locking/unlocking (from inside)..... 65
- Locking/unlocking (KEYLESS-GO)..... 65
- Lowering..... 329
- Maintenance..... 20
- Medical aids..... 25
- Parking for an extended period..... 161
- Problem notification..... 26
- QR code rescue card..... 27
- Qualified specialist workshop..... 25
- Raising..... 326
- Standby mode function..... 162
- Starting (emergency operation mode).... 136
- Starting (Remote Online)..... 137
- Starting (start/stop button)..... 135
- Switching off (start/stop button)..... 155
- Switching on (start/stop button)..... 134
- Towing..... 215
- Ventilating (convenience opening)..... 76
- Vehicle battery**  
see On-board electrical system battery (12 V)
- Vehicle camera**  
Information..... 163
- Vehicle data**  
Displaying (DYNAMIC SELECT)..... 148  
Roof load..... 344  
Turning radius..... 343  
Vehicle height..... 343  
Vehicle length..... 343  
Vehicle width..... 343  
Wheelbase..... 343
- Vehicle data storage**  
Event data recorders..... 31  
MBUX multimedia system/Mercedes  
me connect..... 31
- Vehicle dimensions**..... 343
- Vehicle emergency start**..... 297
- Vehicle identification number**  
see VIN
- Vehicle identification plate**  
Paint code..... 335
- VIN..... 335
- Vehicle interior**  
Cooling or heating (Remote Online)..... 136
- Vehicle maintenance**  
see ASSYST PLUS
- Vehicle operation**  
Outside the USA or Canada..... 20
- Vehicle sensors**  
Information..... 163
- Vehicle tool kit**  
TIREFIT kit..... 284  
Towing eye..... 296
- Ventilating**  
Convenience opening..... 76
- Ventilation**  
see Climate control
- Vents**  
see Air vents
- VIN**  
Identification plate..... 335  
Seat..... 335  
Windshield..... 335

**Vision**

- Removing condensation from the windows..... 130
- Windshield heater..... 132

**Voice Control System**

- Function..... 227
- Starting..... 228

**W****Warning lamp**

see Warning/indicator lamp





**Warning system**





see ATA (anti-theft alarm system)









**Warning triangle**

- Removing..... 281
- Setting up..... 282

**Warning/indicator lamp**

-  ABS warning lamp..... 408
-  Active Brake Assist warning lamp.. 407
-  Brake system warning lamp  
(Canada only)..... 406
-  Brake warning lamp (USA only).... 406

-  Brakes warning lamp (yellow)  
(Canada only)..... 405
-  Coolant warning lamp (red)..... 400
-  Coolant warning lamp (yellow)..... 401
-  Electric parking brake indicator  
lamp (red) (Canada only)..... 404
-  Electric parking brake indicator  
lamp (red) (USA only)..... 404
-  Electrical malfunction warning  
lamp..... 402
-  Engine diagnosis warning lamp..... 402
-  ESP® OFF warning lamp..... 410
-  ESP® warning lamp flashes..... 409
-  ESP® warning lamp lights up..... 409
-  Fuel reserve warning lamp flashes..... 402
-  Fuel reserve warning lamp lights  
up..... 403
-  Power steering warning lamp  
(red)..... 399

-  Recuperative Brake System  
warning lamp (USA only)..... 405
-  Restraint system warning lamp..... 398
-  Seat belt warning lamp flashes..... 398
-  Seat belt warning lamp lights up... 399
-  Suspension warning lamp (yel-  
low)..... 408
-  The electric parking brake (yel-  
low) indicator lamp..... 404
-  Tire pressure monitoring system  
warning lamp flashes..... 411
-  Tire pressure monitoring system  
warning lamp lights up..... 411
-  Warning lamp for distance  
warning function..... 407
- Overview..... 397
- PASSENGER AIR BAG..... 43
- Warranty**..... 27

**Washer fluid**

see Windshield washer fluid

- Washing by hand (care)**..... 275
- Water tank**  
see Air-water duct
- Weather information**..... 242
- Web browsers**  
Overview..... 254
- Wheel change**  
Lowering the vehicle..... 329  
Mounting a new wheel..... 328  
Removing a wheel..... 328  
Removing/installing hub caps..... 325
- Wheel rotation**..... 323
- Wheels**  
Care..... 277  
Checking..... 301  
Checking the tire pressure (manually).... 305  
Checking the tire pressure (tire pressure monitoring system)..... 306  
Definitions..... 318  
DOT, Tire Identification Number (TIN).... 314  
Flat tire..... 282  
Installing..... 328  
Load index..... 316  
Load-bearing capacity..... 316  
Maximum tire load..... 315  
Maximum tire pressure..... 315  
MOExtended tires..... 283  
Noise generation..... 301  
Notes on installing..... 320  
Overview of tire labeling..... 313  
Removing..... 328  
Replacing..... 320, 324  
Replacing the hub cap..... 325  
Restarting the tire pressure loss warning system..... 308  
Restarting the tire pressure monitoring system..... 307  
Rotating..... 323  
Selection..... 320  
Snow chains..... 302  
Speed rating..... 316  
Storing..... 324  
Temperature grade..... 313  
Tire and Loading Information placard.... 308  
Tire characteristics..... 316  
Tire pressure (notes)..... 302  
Tire pressure loss warning system (function)..... 307  
Tire pressure monitoring system (function)..... 305  
Tire pressure table..... 304  
Tire Quality Grading..... 313  
Tire size designation..... 316  
TIREFIT kit..... 284  
Traction grade..... 313  
Tread wear grade..... 313  
Unfamiliar handling..... 301
- Wi-Fi**  
Setting..... 234
- Window curtain airbag**..... 39
- Window lifter**  
see Side windows
- Windows**  
Care..... 277
- Windows**  
see Side windows
- Windshield**  
Defrosting..... 127  
Infrared reflective..... 126  
Radio waves..... 126  
Replacing the wiper blades..... 121
- Windshield**  
see Windshield

- 
- Windshield heater**..... 132
- Windshield heater**  
see Windshield heater
- Windshield washer fluid**  
Notes..... 341
- Windshield washer system**  
Refilling..... 273
- Windshield wipers**  
Activating/deactivating..... 121  
Replacing the wiper blades..... 121
- Winter operation**  
Snow chains..... 302
- Wiper blades**  
Care..... 277  
Replacing (windshield)..... 121
- Wireless charging**  
Function/notes..... 107  
Mobile phone..... 109
- Wireless vehicle components**  
Declaration of conformity..... 23
- Workout program**  
Overview..... 90
- Workshop**  
see Qualified specialist workshop