



#### Digital – in the vehicle

Familiarize yourself with the contents of the Operator's Manual directly via the vehicle's multimedia system (menu item "Vehicle"). Start with the quick guide, discover your vehicle's highlights or broaden your knowledge with useful tips.



#### Vehicle document wallet

Here you can find comprehensive information about operating your vehicle and about services and guarantees in printed form.



2055841030

Order no. P205 2613 13 Part no. 205 584 10 30  
Edition A-2023

C-Class Coupe

Mercedes-Benz



## C-Class Coupe

Operator's Manual

Mercedes-Benz



## Front passenger airbag warning

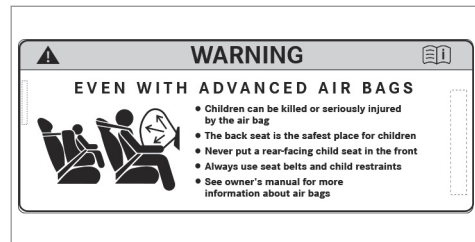

Airbag warning sticker for USA and Canada

**⚠ WARNING** Risk of injury or death if the co-driver airbag is enabled

If the co-driver airbag is enabled, a child on the co-driver seat may be struck by the co-driver airbag during an accident.

NEVER use a rearward-facing child restraint system on a seat with an ENABLED FRONT AIRBAG; DEATH or SERIOUS INJURY to the CHILD can occur.

Observe the chapter "Children in the vehicle".

## Publication details

### Internet

Further information about Mercedes-Benz vehicles and about Mercedes-Benz AG can be found on the following websites:

<https://www.mbusa.com> (USA only)

<https://www.mercedes-benz.ca> (Canada only)

### Documentation team

©Mercedes-Benz AG: Not to be reprinted, translated or otherwise reproduced, in whole or in part, without written permission from Mercedes-Benz AG.

### Vehicle manufacturer

Mercedes-Benz AG

Mercedesstraße 120

70372 Stuttgart

Germany

As at 16.08.21

## Welcome to the world of Mercedes-Benz

Before you first drive off, read this operator's manual carefully and familiarize yourself with your vehicle. For your own safety and a longer operating lifespan of the vehicle, follow the instructions and warning notices in this operator's manual. Disregarding them may result in damage to the vehicle or personal injury.

Damage to the vehicle resulting from the disregard of the instructions is not covered by the Mercedes-Benz Limited Warranty.

The equipment and product description of your vehicle may vary and depends on the following factors:

- Model
- Order
- National version
- Availability

Your vehicle may therefore differ, in individual cases, from that described and shown in the illustrations.

Mercedes-Benz reserves the right to introduce changes in the following areas:

- Design
- Equipment
- Technical features

The following documents are integral parts of the vehicle:

- Digital operator's manual
- Printed operator's manual
- Service booklet
- Equipment-dependent supplements
- Supplementary documents

Keep these documents in the vehicle at all times. Ensure that all documents are in the vehicle or passed on in the event of sale or rental.

Mercedes-Benz USA, LLC

Mercedes-Benz Canada, Inc.

A Daimler Company

2055841030



<b>Symbols</b> .....	5	Diagnostics connection .....	26	Side windows .....	75
		Qualified specialist workshop .....	27	Sliding sunroof .....	79
		Correct use of the vehicle .....	28	Anti-theft protection .....	82
<b>At a glance</b> .....	6	Notes for persons with electronic medical aids .....	28		
Cockpit .....	6	Problems with your vehicle .....	28	<b>Seats and stowing</b> .....	<b>86</b>
Indicator and warning lamps (standard) .....	10	Reporting safety defects .....	29	Notes on the correct driver's seat position ....	86
Indicator and warning lamps (widescreen cockpit) .....	12	Limited Warranty .....	30	Seats .....	87
Overhead control panel .....	14	QR code for rescue card .....	30	Steering wheel .....	95
Door operating unit and seat adjustment .....	16	Data storage .....	30	Easy entry and exit feature .....	97
Emergencies and breakdowns .....	18	Copyright .....	34	Memory function .....	98
				Stowage areas .....	99
				Sockets .....	108
				Wireless charging of the mobile phone and connection with the exterior antenna ....	108
<b>Digital Operator's Manual</b> .....	<b>20</b>	<b>Occupant safety</b> .....	<b>36</b>	Installing/removing the floor mats .....	110
Calling up the Digital Operator's Manual .....	20	Restraint system .....	36		
		Seat belts .....	38	<b>Light and visibility</b> .....	<b>112</b>
		Airbags .....	43	Exterior lighting .....	112
<b>General notes</b> .....	<b>21</b>	PRE-SAFE® system .....	50	Interior lighting .....	117
Environmental protection .....	21	Safely transporting children in the vehicle .....	51	Windshield wiper and windshield washer system .....	118
Mercedes-Benz GenuineParts .....	21	Notes on pets in the vehicle .....	62	Mirrors .....	120
Operator's manual .....	22				
Mercedes me app .....	23	<b>Opening and closing</b> .....	<b>63</b>		
Service and vehicle operation .....	23	SmartKey .....	63		
Operating safety .....	24	Doors .....	67		
Declaration of conformity for wireless vehicle components .....	26	Trunk .....	70		

<b>Climate control</b> .....	<b>124</b>	<b>Voice Control System</b> .....	<b>211</b>	<b>Breakdown assistance</b> .....	<b>336</b>
Overview of climate control systems .....	124	Notes on operating safety .....	211	Emergency .....	336
Operating the climate control system .....	124	Operation .....	211	Flat tire .....	337
		Using the Voice Control System effectively ..	212	Battery (vehicle) .....	344
		Essential voice commands .....	213	Tow starting or towing away .....	349
				Electrical fuses .....	354
<b>Driving and parking</b> .....	<b>128</b>	<b>Multimedia system</b> .....	<b>225</b>	<b>Wheels and tires</b> .....	<b>357</b>
Driving .....	128	Overview and operation .....	225	Notes on noise or unusual handling char-	
DYNAMIC SELECT switch .....	138	System settings .....	234	acteristics .....	357
Automatic transmission .....	140	Fit & Healthy .....	245	Notes on regularly inspecting wheels and	
Function of the 4MATIC .....	144	Navigation .....	246	tires .....	357
Refueling .....	145	Telephone .....	271	Notes on snow chains .....	358
Parking .....	147	Online and Internet functions .....	295	Tire pressure .....	358
Driving and driving safety systems .....	155	Media .....	298	Loading the vehicle .....	365
Vehicle towing instructions .....	203	Radio .....	311	Tire labeling .....	369
		Sound .....	318	Definition of terms for tires and loading .....	374
				Changing a wheel .....	376
<b>Instrument display and on-board com-</b>		<b>Maintenance and care</b> .....	<b>321</b>	Emergency spare wheel .....	386
<b>puter</b> .....	<b>205</b>	ASSYST PLUS service interval display .....	321		
Notes on the instrument display and on-		Engine compartment .....	322		
board computer .....	205	Cleaning and care .....	328		
Overview of instrument display .....	206			<b>Technical data</b> .....	<b>388</b>
Overview of buttons on the steering wheel ...	207			Notes on technical data .....	388
Operating the on-board computer .....	207			Vehicle electronics .....	388
Overview of displays on the instrument				Regulatory radio identification and notes .....	389
display .....	208				
Head-up Display .....	208				

## 4 Contents

---

Vehicle identification plate, VIN and engine number overview .....	390
Operating fluids .....	392
Vehicle data .....	398

---

<b>Display messages and warning/indicator lamps</b> .....	<b>400</b>
Display messages .....	400
Warning and indicator lamps .....	450

---

<b>Index</b> .....	<b>466</b>
--------------------	------------

In this Operator's Manual, you will find the following symbols:

**⚠ WARNING** Danger due to not observing the warning notices

Warning notices draw your attention to hazards that may endanger your health or life, or the health or life of others.

- ▶ Observe the warning notices.

**🌿 ENVIRONMENTAL NOTE** Environmental damage due to failure to observe environmental notes

Environmental notes include information on environmentally responsible behavior or environmentally responsible disposal.

- ▶ Observe environmental notes.

**! NOTE** Damage to property due to failure to observe notes on material damage

Notes on material damage inform you of risks which may lead to your vehicle being damaged.

- ▶ Observe notes on material damage.

**ⓘ** These symbols indicate useful instructions or further information that could be helpful to you.

▶ Instruction

(→ page) Further information on a topic

**Display** Display field in the Instrument Display/media display

↪ Highest menu level, which is to be selected in the multimedia system

➡➡ Relevant submenus, which are to be selected in the multimedia system

\* Indicates a cause

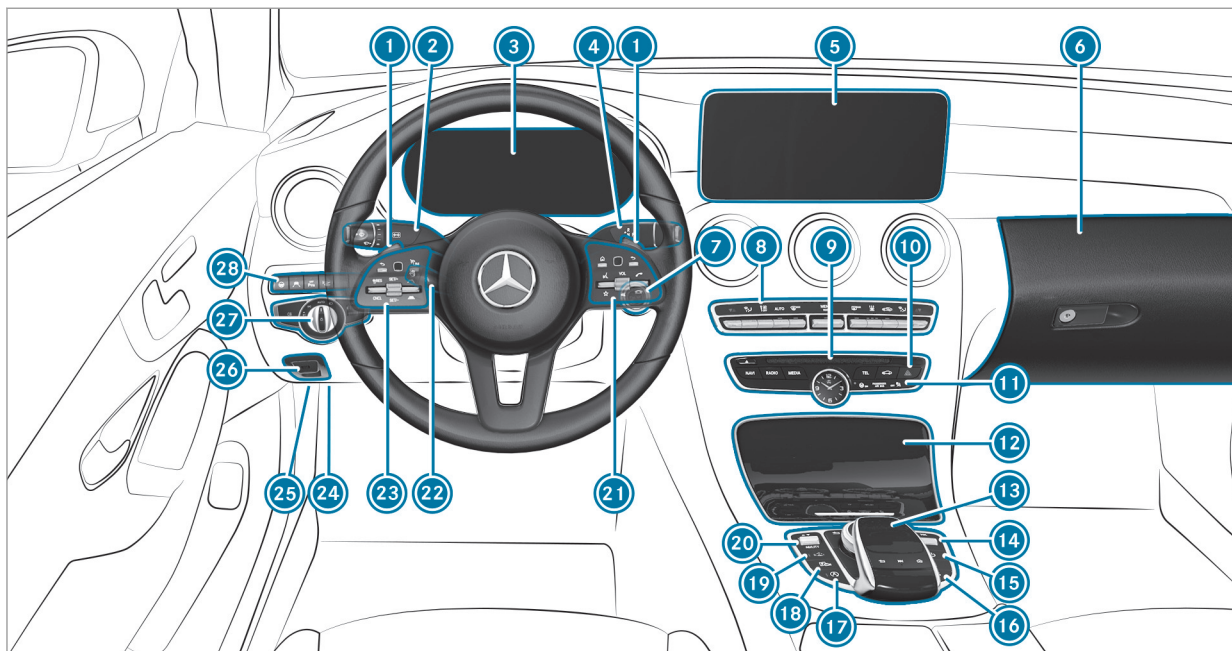

Left-hand-drive vehicles



①	Steering wheel paddle shifters	→	143	⑬	ECO start/stop function	→	137
②	Combination switch	→	113	⑭	Active Parking Assist	→	199
③	Instrument display	→	206	⑮	Set vehicle level	→	188
④	DIRECT SELECT lever	→	140	⑯	DYNAMIC SELECT switch	→	139
⑤	Media display	→	225	⑰	Control panel for the multimedia system	→	207
⑥	Glove box	→	102	⑱	Adjusts the steering wheel electrically	→	96
⑦	Start/stop button	→	129		Switch steering wheel heater on/off	→	96
⑧	Climate control systems	→	124	⑳	Control panel:		
⑨	Call up main multimedia system functions	→	229		On-board computer	→	207
⑩	Hazard warning light system	→	114		Cruise control	→	163
⑪	PASSENGER air bag indicator lamps	→	47		Active Distance Assist DISTRONIC	→	167
⑫	Stowage space	→	102	㉑	Diagnostics connection	→	26
⑬	Touchpad	→	226	㉒	Open hood	→	322
⑭	Controller for volume and switching sound on/off	→	225	㉓	Electric parking brake	→	151
⑮	Switch multimedia system on/off	→	225	㉔	Light switch	→	112
⑯	Extend/retract seat belt extender	→	41	㉕	Control panel for:		
					Active Steering Assist	→	172

## 8 At a glance – Cockpit

---

Active Lane Keeping Assist	→	186
----------------------------	---	-----

Parking Assist PARKTRONIC	→	197
---------------------------	---	-----







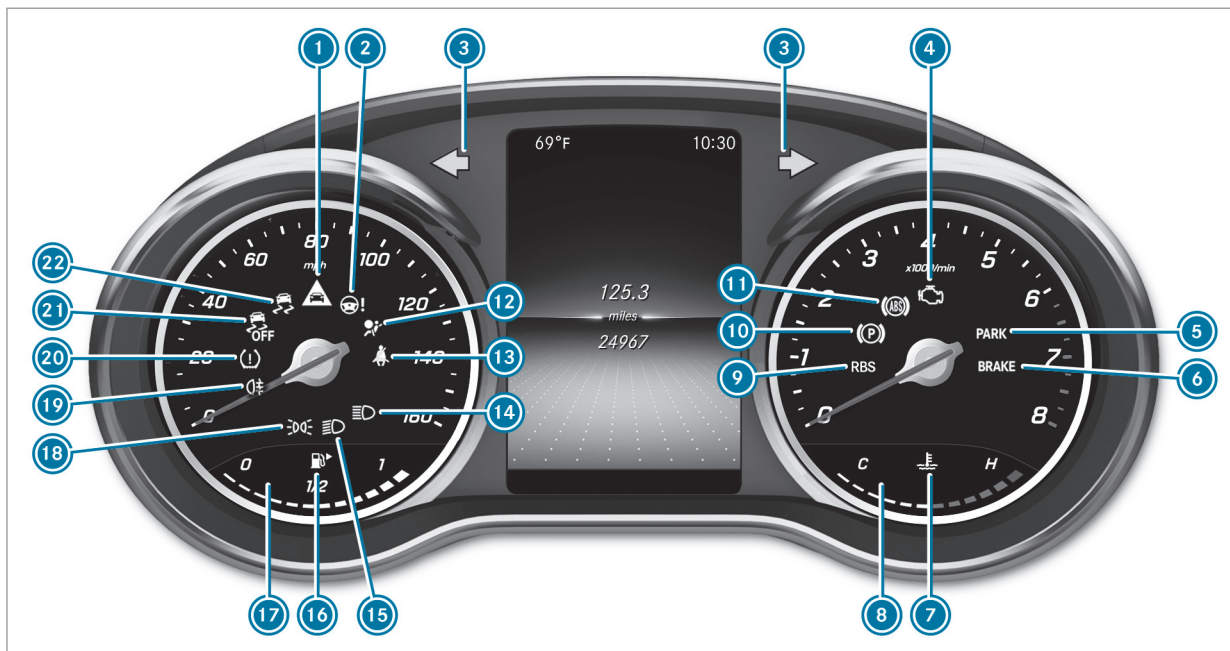



















Head-up display	→	210
-----------------	---	-----



10 At a glance - Indicator and warning lamps (standard)









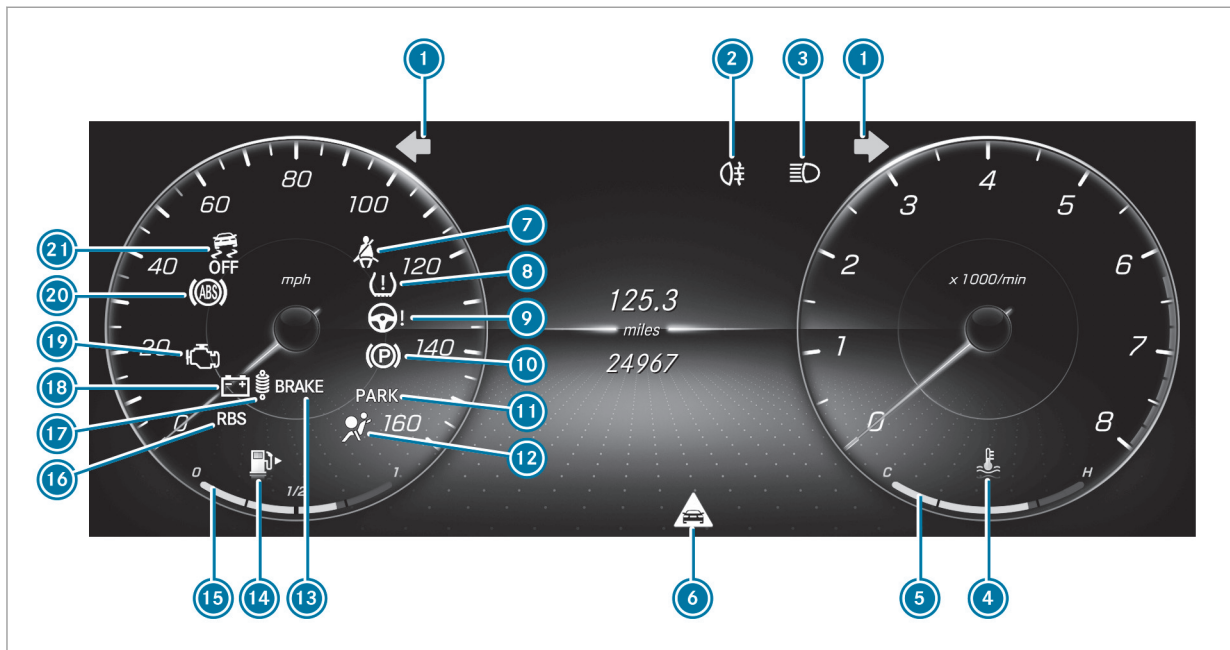



















Standard instrument display

1		Distance warning	→	461	10		Electric parking brake (yellow)	→	458
2		Power steering	→	453	11		ABS	→	462
3		Turn signal lights	→	113	12		Restraint system	→	452
4		Check Engine	→	454	13		Seat belt	→	452
5		Electric parking brake (red)	→	458	14		High beam	→	113
		USA only			15		Low beam	→	112
		Canada only			16		Reserve fuel with fuel filler flap location indicator	→	454
6		Brakes (red)	→	458	17		Fuel level	→	206
		USA only			18		Standing lights	→	112
		Canada only			19		Rear fog light	→	113
7		Coolant temperature	→	454	20		Tire pressure monitoring system	→	464
8		Coolant temperature display	→	206	21		ESP® OFF	→	462
9		Recuperative Brake System, USA only	→	458	22		ESP®	→	462
		Brakes (yellow), Canada only	→	458					

12 At a glance - Indicator and warning lamps (widescreen cockpit)









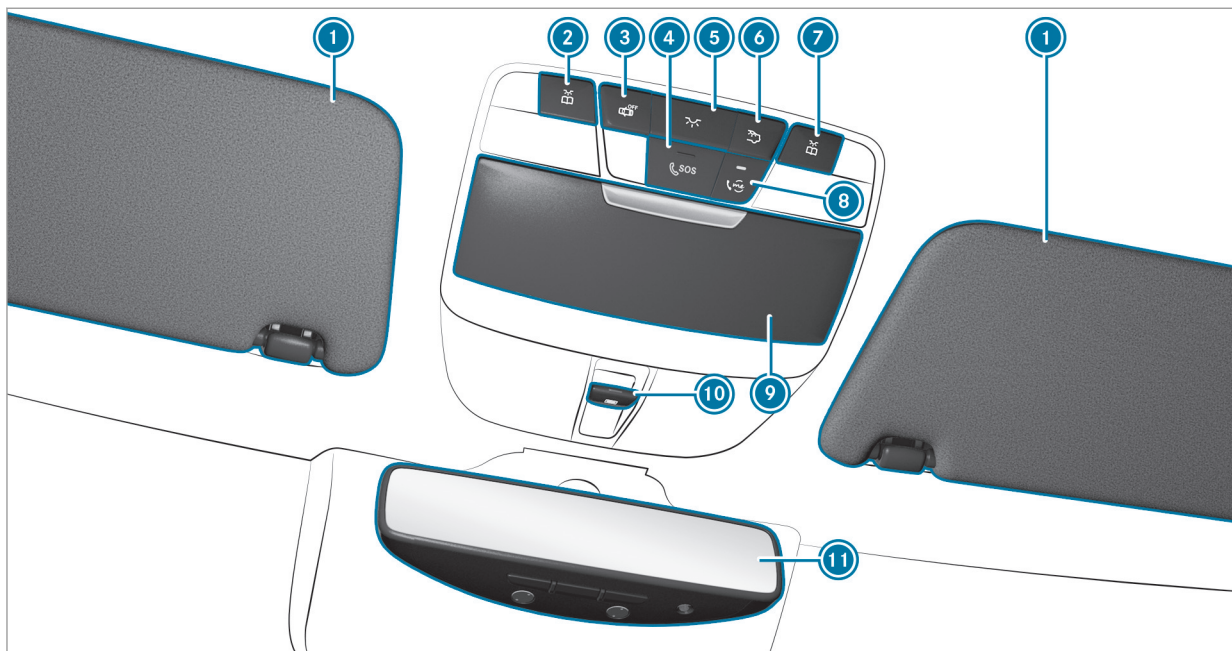

Widescreen cockpit instrument display

①	 	Turn signal lights	→	113	⑫		Restraint system	→	452
②		Rear fog light	→	113	⑬		Brakes (red)	→	458
③		High beam	→	113			USA only		
		Low beam	→	112			Canada only		
		Standing lights	→	112	⑭		Reserve fuel with fuel filler flap location indicator	→	454
④		Coolant temperature	→	454	⑮		Fuel level	→	206
⑤		Coolant temperature display	→	206	⑯		Recuperative Brake System, USA only	→	458
⑥		Distance warning	→	461			Brakes (yellow), Canada only	→	458
⑦		Seat belt	→	452	⑰		Suspension	→	461
⑧		Tire pressure monitoring system	→	464	⑱		Electrical malfunction	→	454
⑨		Power steering	→	453	⑲		Check Engine	→	454
⑩		Electric parking brake (yellow)	→	458	⑳		ABS	→	462
⑪		Electric parking brake (red)	→	458	㉑		ESP® OFF	→	462
		USA only					ESP®	→	462
		Canada only							

14 At a glance – Overhead control panel





①	Sun visors		
②	 Switches the left-hand reading lamp on/off	→	117
③	 Switches automatic interior lighting control on/off	→	117
④	 SOS button	→	288
⑤	 Switches the front interior lighting on/off	→	117
⑥	 Switches the rear interior lighting on/off	→	117
⑦	 Switches the right-hand reading lamp on/off	→	117
⑧	 me button	→	288
⑨	Eyeglasses compartment		
⑩	 Opens/closes the panorama roof with power tilt/sliding panel	→	79
	 Opens/closes the roller sunblind	→	79
⑪	Inside rearview mirror	→	121

16 At a glance - Door operating unit and seat adjustment

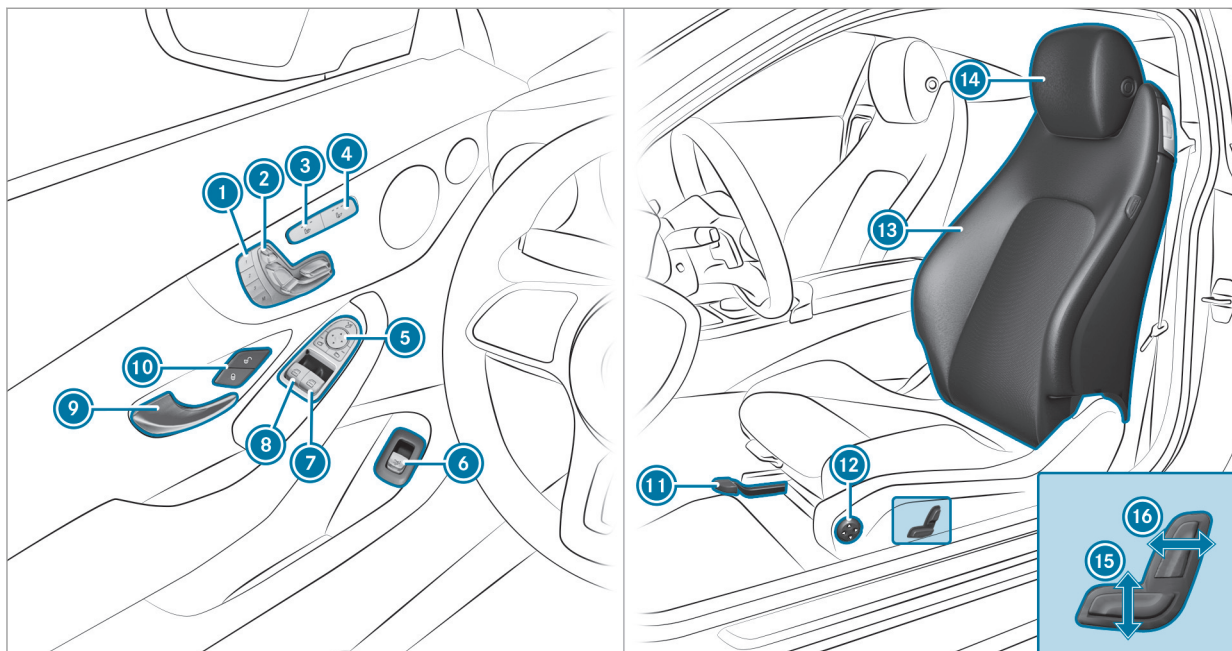

① Operating the memory function	→	99	⑨ Opens the door	→	67
② Adjusts the seats electrically	→	89	⑩ Locks/unlocks the vehicle	→	67
③ Switches the seat heating on/off	→	94	⑪ Adjusts the seat fore-and-aft position	→	87
④ Switches the seat ventilation on/off	→	94	⑫ Adjusts the 4-way lumbar support	→	90
⑤ Operating the outside mirrors	→	120	⑬ Seat adjustment using the multimedia system	→	92
⑥ Opens/closes the trunk lid	→	70	⑭ Adjusts the head restraints	→	89
⑦ Opens/closes the right side window	→	75	⑮ Adjusts the seat height	→	87
⑧ Opens/closes the left side window	→	75	⑯ Adjusts the seat backrest inclination	→	87

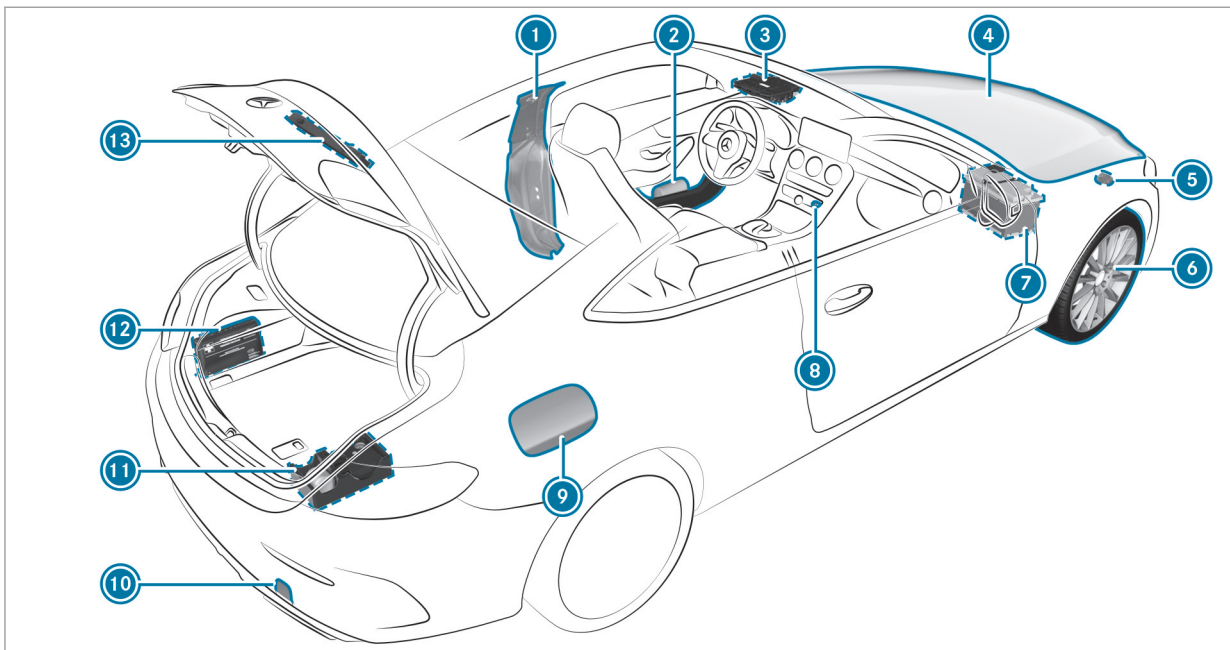

1	B-pillar with: QR code for accessing the rescue card	→	30
2	Safety vests	→	336
3	me button and SOS button	→	288
4	To check and refill operating fluids	→	392
5	To tow-start and tow away	→	349
6	Flat tire	→	337
7	Starting assistance	→	347
8	Hazard warning light system	→	114

9	Fuel filler flap with: information label on fuel type	→	145
	Information label on tire pressure	→	360
	QR code for accessing the rescue card	→	30
10	To tow-start and tow away	→	349
11	TIREFIT kit	→	339
12	First-aid kit (soft sided)	→	337
13	Warning triangle	→	336

### Calling up the Digital Operator's Manual

Multimedia system:

→ Vehicle → ⓘ Operator's Manual

▶ Select a menu item.

In addition, you can also call up the Operator's Manual within a main function (e.g. via [Media Info](#)).

The Digital Operator's Manual describes the function and operation of the vehicle and the multimedia system.

For safety reasons, the Digital Operator's Manual is deactivated while driving.



The Digital Operator's Manual contains the following menu items:

- **Search:** allows you to search for specific keywords.
- **Quick start:** provides you with important information so that you can start using your vehicle immediately.
- **Tips:** provides tips on how to use your vehicle in certain situations.
- **Messages:** provides you with further information about the messages in the instrument cluster.
- **Bookmarks:** provides you with a list of all the bookmarks you have stored yourself.

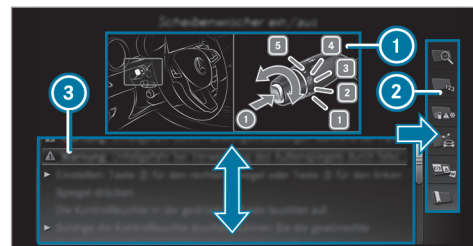

- ① Picture
- ② Menu
- ③ Navigation window

Some sections of the Digital Operator's Manual, such as warnings, can be made visible by highlighting and pressing them.

## Environmental protection

 **ENVIRONMENTAL NOTE** Environmental damage due to operating conditions and personal driving style

The pollutant emission of the vehicle is directly related to the way you operate the vehicle.

Operate your vehicle in an environmentally responsible manner to help protect the environment. Please observe the following recommendations on operating conditions and personal driving style.

### Operating conditions:

- ▶ Make sure that the tire pressure is correct.
- ▶ Do not carry any unnecessary weight (e.g. roof luggage racks once you no longer need them).
- ▶ Adhere to the service intervals. A regularly serviced vehicle will contribute to environmental protection.

- ▶ Always have maintenance work carried out at a qualified specialist workshop.

### Personal driving style:

- ▶ Do not depress the accelerator pedal when starting the engine.
- ▶ Do not warm up the vehicle while stationary.
- ▶ Drive carefully and maintain a suitable distance from the vehicle in front.
- ▶ Avoid frequent, sudden acceleration and braking.
- ▶ Change gear in good time and use each gear only up to  $\frac{2}{3}$  of its maximum engine speed.
- ▶ Switch off the vehicle in stationary traffic, e.g. by using the ECO start/stop function.
- ▶ Drive in a fuel-efficient manner. Observe the ECO display for an economical driving style.

## Environmental issues and recommendations

It is recommended that you re-use or recycle materials instead of just disposing of them.

The relevant environmental guidelines and regulations serve to protect the environment and must be strictly observed.

## Mercedes-Benz GenuineParts

 **ENVIRONMENTAL NOTE** Environmental damage due to not using recycled reconditioned components

Mercedes-Benz AG offers recycled reconditioned components and parts with the same quality as new parts. The same entitlement from the Limited Warranty is valid as for new parts.

- ▶ Use recycled reconditioned components and parts from Mercedes-Benz AG.

**!** **NOTE** Impairment of the operating efficiency of the restraint systems from installing accessory parts or from repairs or welding

Air bags and Emergency Tensioning Devices, as well as control units and sensors for the restraint systems, may be installed in the following areas of your vehicle:

- doors
- door pillars
- sill
- seats
- cockpit
- instrument display
- center console
- lateral roof frame

- ▶ Do not install accessory parts such as audio systems in these areas.
- ▶ Do not carry out repairs or welding.
- ▶ Have accessories retrofitted at a qualified specialist workshop.

You could jeopardize the operating safety of your vehicle if you use parts, tires and wheels as well as accessories relevant to safety which have not been approved by Mercedes-Benz. Safety-relevant systems (e.g. the brake system) may malfunction. Only use Mercedes-Benz GenuineParts or parts of equal quality. Only use tires, wheels and accessory parts that have been specifically approved for your vehicle model.

Mercedes-Benz GenuineParts are subject to strict quality inspections. Each part has been specially developed, manufactured or selected for Mercedes-Benz vehicles and adapted to them. Therefore, only Mercedes-Benz GenuineParts should be used.

More than 300,000 different Mercedes-Benz GenuineParts are available for Mercedes-Benz models.

All authorized Mercedes-Benz Service Centers maintain a supply of Mercedes-Benz GenuineParts for necessary service and repair work. In addition, strategically located parts delivery centers provide for quick and reliable parts service.

Always specify the vehicle identification number (VIN) (→ page 390) when ordering Mercedes-Benz GenuineParts.

### Operator's manual

This Operator's Manual and the Digital Operator's Manual in the vehicle describe the following models and the standard and special equipment for your vehicle:

- The models and the standard and special equipment available at the time of this Operator's Manual going to press.
- The models and the standard and special equipment only available in certain countries.
- The models and the standard and special equipment, which will only be available at a later date.

Note that your vehicle may not be installed with all features described. This is also the case for systems relevant to safety. Therefore, the equipment on your vehicle may differ from that in the descriptions and illustrations.



The original purchase agreement for your vehicle contains a list of the equipment in your vehicle at the time of delivery.

Should you have any questions concerning equipment and operation, please consult an authorized Mercedes-Benz Center.

The Operator's Manual, Operating Instructions, further supplementary documents and Service Booklet are important documents and should be kept in the vehicle.

### Mercedes me app

#### Notes about the on-demand feature

You can also activate various functions (on-demand feature) subsequently via Mercedes me after purchasing your vehicle.

Information is available at any authorized Mercedes-Benz Service Center.

#### Activating on-demand feature using Mercedes me

##### Requirements

- The vehicle has a wireless connection.

- The vehicle is linked to the Mercedes me user account.

#### Ordering and activating on-demand feature

- ▶ Add the desired on-demand feature for the vehicle to the shopping basket in the Mercedes me Store.
- ▶ Complete the order.  
The on-demand feature is activated when operating the vehicle.

#### Speeding up activation

- ▶ Switch the vehicle off and lock it.
- ▶ Unlock the vehicle after about two minutes and switch on the vehicle.  
The on-demand feature has been activated. For some features, a notification also appears in the vehicle's multimedia system.

If the activation was not successful, repeat the process.

### Service and vehicle operation

#### Vehicle operation outside the USA or Canada

When you are abroad with your vehicle, observe the following points:

- service points or replacement parts may not be available immediately.
- unleaded fuel may not be available for vehicles with a catalytic converter. Leaded fuel may cause damage to the catalytic converter.
- the fuel may have an extremely low octane number. Unsuitable fuel can cause engine damage.

Some Mercedes-Benz models are available in Europe through our European Delivery Program. For more information, please consult an authorized Mercedes-Benz Service Center, or write to one of the following addresses:

##### in the USA:

Mercedes-Benz USA, LLC  
European Delivery Department  
One Mercedes-Benz Drive  
Sandy Springs, GA 30328

### in Canada:

Mercedes-Benz Canada, Inc.  
European Delivery Department  
98 Vanderhoof Avenue  
Toronto, Ontario M4G 4C9

### Maintenance

Your customer advisor confirms the service in the service report.

### Roadside Assistance

The Mercedes-Benz Roadside Assistance Program offers technical help in the case of a breakdown. Your calls to the toll-free Roadside Assistance Hotline are answered by our agents 24 hours a day, 365 days a year.

1-800-FOR-MERCEdes (1-800-367-6372) (USA)  
1-800-387-0100 (Canada)

You can find further information in the Mercedes-Benz Roadside Assistance Program brochure (USA) or the "Roadside Assistance" section in the

Service and Warranty booklet (Canada). You will find both in the vehicle document wallet.

### Change of address or change of ownership

In the event of a change of address, please send us the "Notification of address change" in the Service and Guarantee booklet or simply call the Mercedes-Benz Customer Assistance Center (USA) on the hotline number 1-800-FOR-MERCEdes (1-800-367-6372) or Customer Service (Canada) on 1-800-387-0100. We can then reach you in a timely fashion, if necessary.

If you sell your Mercedes, please leave all literature in the vehicle so that it is available to the next owner. If you have purchased a used vehicle, please send us the "Notice of Purchase of Used Car" in the Service and Guarantee booklet or simply call the Mercedes-Benz Customer Assistance Center (USA) at the hotline number 1-800-FOR-MERCEdes (1-800-367-6372) or Customer Service (Canada) at 1-800-387-0100.

### Possible danger due to substances hazardous to health

In compliance with Proposition 65 ("Prop65"), the following detachable label has been added to each vehicle sold in California:



### Operating safety

**⚠ WARNING** Risk of accident due to malfunctions or system failures

If you do not have the prescribed service/maintenance work or any required repairs car-

ried out, this could result in malfunctions or system failures.

- ▶ Always have the prescribed service and maintenance work as well any required repairs carried out at a qualified specialist workshop.

**⚠ WARNING** Risk of accident or injury due to incorrect modifications on electronic component parts

Modification of electronic components, their software or wiring could impair their function and/or the function of other networked component parts or safety-relevant systems.

This can endanger the operating safety of the vehicle.

- ▶ Never tamper with the wiring and electronic component parts or their software.
- ▶ You should have all work on electrical and electronic components carried out at a qualified specialist workshop.

Observe the "On-board electronics" section in "Technical data".

**⚠ WARNING** Risk of fire caused by flammable material on hot exhaust system components

Flammable material such as leaves, grass or twigs may ignite if they come into contact with hot parts of the exhaust system.

- ▶ When driving on an unpaved road or off-road, check the vehicle underside regularly.
- ▶ In particular, remove trapped plant parts or other flammable material.
- ▶ If there is damage, consult a qualified specialist workshop immediately.

**! NOTE** Damage to the vehicle due to driving too fast and due to impacts to the vehicle underbody or suspension components

In the following situations, in particular, there is a risk of damage to the vehicle:

- The vehicle becomes grounded, e.g. on a high curb or an unpaved road
- The vehicle is driven too fast over an obstacle, e.g. a curb, speed bump or pothole
- A heavy object strikes the underbody or suspension components

In situations such as these, damage to the body, underbody, suspension components, wheels or tires may not be visible. Components damaged in this way can unexpectedly fail or, in the case of an accident, may no longer absorb the resulting force as intended.

If the underbody paneling is damaged, flammable materials such as leaves, grass or twigs can collect between the underbody and the

underbody paneling. These materials may ignite if they come into contact with hot parts of the exhaust system.

- ▶ Have the vehicle checked and repaired immediately at a qualified specialist workshop.

or

- ▶ If driving safety is impaired while continuing your journey, pull over and stop the vehicle immediately, while paying attention to road and traffic conditions, and contact a qualified specialist workshop.

#### Declaration of conformity for wireless vehicle components



USA: "Radio based devices of this vehicle comply with Part 15 of the FCC Rules. Operation is subject to the following two conditions: 1) These devi-

ces may not cause harmful interference, and 2) These devices must accept any interference received, including interference that may cause undesired operation. Changes or modifications not expressly approved by the party responsible for compliance could void the user's authority to operate the equipment."

Canada: "This vehicle contains licence-exempt transmitter(s)/receiver(s) that comply with Innovation, Science and Economic Development Canada's licence-exempt RSS(s). Operation is subject to the following two conditions: (1) These devices may not cause interference. (2) These devices must accept any interference, including interference that may cause undesired operation of the devices." "Les émetteurs/récepteurs dans ce véhicule sont conforme aux CNR d'Innovation, Sciences et Développement économique Canada applicables aux appareils radio exempts de licence. L'exploitation est autorisée aux deux conditions suivantes : 1) Ces appareils ne doivent pas produire de brouillage; 2) Ces appareils doivent accepter tout brouillage radioélectrique subi, même si le brouillage est susceptible d'en compromettre le fonctionnement."

#### Diagnostics connection

The diagnostics connection is a technical interface in the vehicle. It is used, for example, during repair and maintenance work or for reading out vehicle data in a specialist workshop. Diagnostic devices should therefore only be connected in a qualified specialist workshop.

**⚠ WARNING** Risk of accident due to connecting devices to the diagnostics connection

If you connect devices to the diagnostics connection of the vehicle, the function of vehicle systems and operating safety may be impaired.

- ▶ For safety reasons, we recommend that you use and connect only products approved by an authorized Mercedes-Benz Service Center.

**⚠ WARNING** Risk of accident due to objects in the driver's footwell

Objects in the driver's footwell may impede pedal travel or block a depressed pedal.

This jeopardizes the operating and road safety of the vehicle.

- ▶ Stow all objects in the vehicle securely so that they cannot get into the driver's footwell.
- ▶ Always install the floor mats securely and as prescribed in order to ensure that there is always sufficient room for the pedals.
- ▶ Do not use loose floor mats and do not place floor mats on top of one another.

**! NOTE** Battery discharging from using devices connected to the diagnostics connection

Using devices at the diagnostics connection drains the battery.

- ▶ Check the charge level of the battery.

- ▶ If the charge level is low, charge the battery, e.g. by driving a considerable distance.

Please also note the information about the 12 V battery and short-distance trips in the "Driving and Parking" chapter (→ page 133).

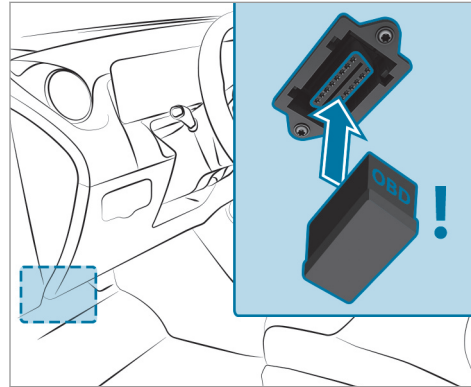

Connecting and using another device with the diagnostics connection can have the following effects:

- Malfunctions in the vehicle system
- Permanent damage to vehicle components

Please refer to the warranty terms and conditions for this matter.

Moreover, connecting equipment to the diagnostics connection can lead to emissions monitoring information being reset, for example. This may lead to the vehicle failing to meet the requirements of the next emissions inspection during the main inspection.

#### Qualified specialist workshop

An authorized Mercedes-Benz Service Center is a qualified specialist workshop. It has the necessary special skills, tools and qualifications to correctly carry out the work required on your vehicle. This particularly applies to safety-relevant works.

For the following, always have your vehicle checked at an authorized Mercedes-Benz Service Center:

- Safety-relevant works
- Service and maintenance work
- Repair work
- Modifications as well as installations and conversions
- Work on electronic components

Mercedes-Benz recommends a Mercedes-Benz Service Center.

### Correct use of the vehicle

If you remove any warning stickers, you or others could fail to recognize certain dangers. Leave warning stickers in position.

Observe the following information in particular when driving your vehicle:

- the safety notes in this Operator's Manual, vehicle-specific supplements and further supplementary documents
- technical data for the vehicle

- traffic rules and -regulations
- laws and safety standards pertaining to motor vehicles

### Notes for persons with electronic medical aids

Mercedes-Benz AG cannot, despite carefully developing vehicle systems, completely rule out the interaction of vehicle systems with electronic medical aids such as cardiac pacemakers.

In addition, there are components installed in the vehicle that, regardless of the operating status of the vehicle, can generate magnetic fields on a par with permanent magnets. These fields can be found, for example, in the area around the multimedia and sound system or also in the area of the seats, depending on the vehicle equipment.

For this reason, the following can occur in isolated cases, depending on the aids used:

- Medical aids malfunctioning
- Adverse health effects

Observe the notes and warnings of the manufacturer of the medical aids; if in doubt, contact the

device manufacturer and/or your doctor. If there is continuing uncertainty concerning the possibility of medical aids malfunctioning, Mercedes-Benz AG recommends using only few electrical vehicle systems and/or maintaining a distance from the components.

Only have repairs and maintenance work in the area of the following components carried out at a qualified specialist workshop:

- Vehicle components carrying live voltage
- Transmission antenna
- Multimedia system and sound system

If you have any queries or suggestions, consult a qualified specialist workshop.

### Problems with your vehicle

If you should experience a problem with your vehicle, particularly one that you believe may affect its safe operation, we urge you to contact an authorized Mercedes-Benz Center immediately to have the problem diagnosed and rectified. If the problem is not resolved to your satisfaction, please discuss the problem again with an authorized

Mercedes-Benz Center or, if necessary, contact us at one of the following addresses:

**In the USA:**

Mercedes-Benz USA, LLC  
Customer Assistance Center  
One Mercedes-Benz Drive  
Sandy Springs, GA 30328

**In Canada:**

Mercedes-Benz Canada, Inc.  
Customer Relations Department  
98 Vanderhoof Avenue  
Toronto, Ontario M4G 4C9

### Reporting safety defects

**USA only:**

The following text is published as required of manufacturers under Title 49, Code of U.S. Federal Regulations, Part 575 pursuant to the "National Traffic and Motor Vehicle Safety Act of 1966".

If you believe that your vehicle has a defect which could cause a crash or could cause injury or

death, you should immediately inform the National Highway Traffic Safety Administration (NHTSA) in addition to notifying Mercedes-Benz USA, LLC.

If NHTSA receives similar complaints, it may open an investigation, and if it finds that a safety defect exists in a group of vehicles, it may order a recall and remedy campaign. However, NHTSA cannot become involved in individual problems between you, your dealer, or Mercedes-Benz USA, LLC.

To contact NHTSA, you may call the Vehicle Safety Hotline toll-free at 1-888-327-4236 (TTY: 1-800-424-9153); go to the <https://www.safercar.gov/>; or write to: Administrator, NHTSA, 400 Seventh Street, SW., Washington, DC 20590.; USA.

You can also obtain other information about motor vehicle safety from: <https://www.safercar.gov>

**Canada only:**

The following text is published as required of manufacturers under subsection 18.4 (4) of the Motor Vehicle Safety Regulations.

If you believe that your vehicle has a defect which could cause a crash or could cause injury or death, you should immediately inform Transport

Canada in addition to notifying Mercedes-Benz Canada Inc.

If Transport Canada received similar complaints, it may open an investigation, and if it finds that a safety defect exists in a group of vehicles, it may order a recall and remedy campaign. However, Transport Canada cannot become involved in individual problems between you, your dealer or Mercedes-Benz Canada Inc.

To contact Transport Canada, you may call the Defect Investigations and Recalls Division toll-free in Canada at 1-800-333-0510 or 819-994-3328 in the Gatineau-Ottawa area or internationally; you may also go to the following websites for more information:

- English: <https://www.tc.gc.ca/recalls>
- French: <https://www.tc.gc.ca/rappels>

### Limited Warranty

**!** **NOTE** Damage to the vehicle arising from violation of these operating instructions.

Damage to the vehicle can arise from violation of these operating instructions.

This damage is not covered either by the Mercedes-Benz implied warranty or by the New- or Used-Vehicle Warranty.

- ▶ Follow the instructions in these operating instructions on proper operation of your vehicle as well as on possible vehicle damage.

### QR code for rescue card

QR codes are attached in the fuel filler flap and on the opposite side on the B-pillar. In the event of an accident, rescue services can use the QR code to quickly find the appropriate rescue card for your vehicle. The current rescue card contains the most important information about your vehicle (e.g. the routing of the electric lines) in compact form.

Further information can be obtained at <https://www.mercedes-benz.de/qr-code>

### Data storage

#### Data processing in the vehicle

##### Electronic control units

Electronic control units are installed in your vehicle. Control units process data which, for example, they receive from vehicle sensors, generate themselves or exchange between themselves. Some control units are required for the safe operation of your vehicle, some assist you when driving, such as driver assistance systems, while others enable convenience or infotainment functions.

The following provides you with general information regarding data processing in the vehicle. Additional information regarding exactly which data in your vehicle are collected, saved and transmitted to third parties, and for what purpose, can be found in the information directly related to the functional characteristics in question in their respective operating instructions. This information is also available online and, depending on the vehicle equipment, digitally.

##### Personal data

Every vehicle is identified by a unique vehicle identification number. Depending on the country, this vehicle identification number can be used by, for example, governmental authorities to determine the identity of the owner. There are other possibilities to use data collected from the vehicle to identify the owner or driver, such as the license plate number.

Therefore, data generated or processed by control units may be attributable to a person or, under certain conditions, become attributable to a person. Depending on which vehicle data are available, it may be possible to make inferences about, for example, your driving behavior, your location, your route or your use patterns.

##### Legal requirements regarding the disclosure of data

If legally required to do so, manufacturers are, in individual cases, legally obliged to provide governmental entities, upon request and to the extent required, data stored by the manufacturer. For example, this may be the case during the investigation of a criminal offense.



Governmental entities are themselves, in individual cases and within the applicable legal framework, authorized to read out data from the vehicle. In the case of an accident, information that can help with an investigation can, therefore, be taken from the air bag control unit, for example.

### Operational data in the vehicle

This is data regarding the operation of the vehicle, which have been processed by control units.

This includes the following data, for example:

- vehicle status information such as the speed, longitudinal acceleration, lateral acceleration, number of wheel revolutions or the fastened seat belts display
- ambient conditions, such as temperature, rain sensor or distance sensor

Generally, the use of these data is temporary; they will not be stored beyond the period of operation and will only be processed within the vehicle itself. Control units often contain data memories for vehicle keys, for example. Their use permits the temporary or permanent documentation of technical information about the vehicle's operat-

ing state, component loads, maintenance requirements and technical events or malfunctions.

Depending on the vehicle equipment, the following data are stored:

- operating status of system components, such as fill levels, tire pressure or battery status
- malfunctions or faults in important system components, such as lights or brakes
- system reactions in special driving situations, such as air bag deployment or the intervention of stability control systems
- information on events leading to vehicle damage

In certain cases, it may be required to store data that would have otherwise been used only temporarily. This may be the case if the vehicle has detected a malfunction, for example.

If you use services, such as repair services and maintenance work, stored operational data as well as the vehicle identification number can be read out and used. They can be read out by service network employees, such as workshops and manufacturers or third parties, such as break-

down services. The same is true in the case of warranty claims and quality assurance measures.

In general, the readout is performed via the legally prescribed port for the diagnostics connection in the vehicle. The operational data that are read out document technical states of the vehicle or of individual components and assist in the diagnosis of malfunctions, compliance with warranty obligations and quality improvement. To that end, these data, in particular information about component loads, technical events, malfunctions and other faults may be transmitted along with the vehicle identification number to the manufacturer. Furthermore, the manufacturer is subject to product liability. For this reason the manufacturer also uses operational data from the vehicle, for example, for recalls. These data can also be used to examine the customer's warranty and guarantee claims.

Malfunction memories in the vehicle can be reset by a service outlet or at your request as part of repair or maintenance work.

### Convenience and infotainment functions

You can store convenience settings and individual settings in the vehicle and change or reset them at any time.

Depending on the vehicle equipment, this includes the following settings, for example:

- seat and steering wheel positions
- suspension and climate control settings
- individual settings, such as interior lighting

Depending on the selected equipment, you can import data into vehicle infotainment functions yourself.

Depending on the vehicle equipment, this includes the following data, for example:

- multimedia data, such as music, films or photos for playback in an integrated multimedia system
- address book data for use in connection with an integrated hands-free system or an integrated navigation system
- entered navigation destinations
- data about the use of Internet services

These data for convenience and infotainment functions may be saved locally in the vehicle or they may be located on a device which you have connected to the vehicle, such as a smartphone, USB flash drive or MP3 player. If you have entered these data yourself, you can delete them at any time.

This data is transmitted from the vehicle to third parties only at your request. This applies, in particular, when you use online services in accordance with the settings that you have selected.

### Smartphone integration (e.g. Android Auto or Apple CarPlay®)

If your vehicle is accordingly equipped, you can connect your smartphone or another mobile end device to the vehicle. You can then control them by means of the control elements integrated in the vehicle. Images and audio from the smartphone can be output via the multimedia system. Certain information is simultaneously transferred to your smartphone. Depending on the type and integration, this includes position data, day/night mode and other general vehicle statuses. For more information please consult the Operator's Manual of the vehicle/infotainment system.

This integration allows the use of selected smartphone apps, such as navigation or music player apps. There is no further interaction between the smartphone and the vehicle; in particular, vehicle data is not directly accessible. The type of additional data processing is determined by the provider of the app being used. Which settings you can make, if any, depends on the specific app and the operating system of your smartphone.

---

### Online services

#### Wireless network connection

If your vehicle has a wireless network connection, it enables data to be exchanged between your vehicle and additional systems. The wireless network connection is made possible by the vehicle's own transmitter and receiver or by a mobile end device that you have brought into the vehicle, for example, a smartphone. Online functions can be used via the wireless network connection. This includes online services and applications/apps provided to you by the manufacturer or by other providers.

### Manufacturer's services

Regarding the manufacturer's online services, the individual functions are described by the manufacturer in a suitable place, for example, in the Operator's Manual or on the manufacturer's website, where the relevant data protection information is also given. Personal data may be used for the provision of online services. Data is exchanged via a secure connection, such as the manufacturer's designated IT systems. Any personal data which is collected, processed and used, other than for the provision of services, is done so exclusively on the basis of legal permission. This is the case, for example, for a legally prescribed emergency call system, a contractual agreement or when consent has been given.

You can have services and functions, some of which are subject to a fee, activated or deactivated. This excludes legally prescribed functions and services, such as an emergency call system.

### Third-party services

If you use online services from other providers (third parties), these services are the responsibility of the provider in question and subject to that provider's data protection conditions and terms of

use. As a general rule, the manufacturer has no influence on the content exchanged.

For this reason, when services are provided by third parties, please ask the service provider in question for information about the type, extent and purpose of the collection and use of personal data.

### Data protection rights

Depending on your country or the equipment and range of functions of your vehicle as well as the services you use and the services on offer, you are entitled to different data protection rights. Further information on data protection and your data protection rights can either be found on the manufacturer's website or you will receive this information as part of the various services and service offers. There you will also find the contact information for the manufacturer and its data protection officers.

At a workshop, for example, with the support of a specialist and possibly for a fee, you can have data read out which is stored only locally in the vehicle.

### Multimedia system / Mercedes me connect

If the vehicle is equipped with the multimedia system or Mercedes me connect, additional data about the vehicle's operation, the use of the vehicle in certain situations and the location of the vehicle may be compiled by the multimedia system or Mercedes me connect.

For additional information, please refer to the chapter "Multimedia system" and/or the Mercedes me connect Terms and Conditions.

### Event Data Recorder

#### USA only:

This vehicle is equipped with an event data recorder (EDR). The main purpose of an EDR is to record, in certain crash or crash-like situations, such as an air bag deployment or hitting a road obstacle, data that will assist in understanding how a vehicle's systems performed. The EDR is designed to record data related to vehicle dynamics and safety systems for a short period of time, typically 30 seconds or less.

The EDR in this vehicle is designed to record such data as:

- How various systems in your vehicle were operating;
- Whether or not the driver and front passenger seat belts were buckled/fastened
- How far (if at all) the driver was depressing the accelerator and/or brake pedal; and,
- How fast the vehicle was traveling.

This data can help provide a better understanding of the circumstances in which crashes and injuries occur. NOTE: EDR data is recorded by your vehicle only if a non-trivial crash situation occurs; no data is recorded by the EDR under normal driving conditions and no personal data (e.g. name, gender, age and accident location) is recorded. However, other parties, such as law enforcement, could combine EDR data with the type of personally identifying data routinely acquired during a crash investigation.

Access to the vehicle and/or the EDR is needed to read data that is recorded by the EDR, and special equipment is required. In addition to the vehicle manufacturer, other parties that have the spe-

cial equipment, such as law enforcement, can read the information by accessing the vehicle or the EDR.

EDR data may be used in civil and criminal matters as a tool in accident reconstruction, accident claims and vehicle safety. Since the Crash Data Retrieval (CDR) tool that is used to extract data from the EDR is commercially available, Mercedes-Benz USA, LLC ("MBUSA") expressly disclaims any and all liability arising from the extraction of this information by unauthorized Mercedes-Benz personnel.

MBUSA will not share EDR data with others without the consent of the vehicle owner or, if the vehicle is leased, without the consent of the lessee. Exceptions to this representation include responses to subpoenas by law enforcement; by federal, state or local government; in connection with or arising out of litigation involving MBUSA or its subsidiaries and affiliates; or, as required by law.

Warning: the EDR is a component of the Restraint System Module. Tampering with, altering, modifying or removing the EDR component may result in

a malfunction of the Restraint System Module and other systems.

State laws or regulations regarding EDRs that conflict with federal regulation are pre-empted. This means that in the event of such conflict, the federal regulation governs. As of December 2016, 17 states have enacted laws relating to EDRs.

#### Copyright

#### Free and open source software

Information on licenses for free and open-source software used in your vehicle can be found on the data carrier in your vehicle document wallet and with updates on the following website:

<https://www.mercedes-benz.com/opensource>

#### Registered trademarks

- Bluetooth® is a registered trademark of Bluetooth SIG, Inc.
- DTS™ is a registered trademark of DTS, Inc.
- Dolby® and MLP™ are registered trademarks of DOLBY Laboratories.

- ESP® and PRE-SAFE® are registered trademarks of Daimler AG.
- HomeLink® is a registered trademark of Genex Corporation.
- iPod® and iTunes® are registered trademarks of Apple Inc.
- Burmester® is a registered trademark of Burmester Audiosysteme GmbH.
- Microsoft® and Windows Media® are registered trademarks of Microsoft Corporation.
- SIRIUS® is a registered trademark of Sirius XM Radio Inc.
- HD Radio™ is a registered trademark of iBiquity Digital Corporation.
- Gracenote® is a registered trademark of Gracenote, Inc.
- ZAGAT Survey® and related brands are registered trademarks of Zagat Survey, LLC.

## Restraint system

### Protection provided by the restraint system

The restraint system includes the following components:

- Seat belt system
- Airbags
- Child restraint system
- Child seat securing systems

The restraint system can help prevent the vehicle occupants from coming into contact with parts of the vehicle interior in the event of an accident. In the event of an accident, the restraint system can also reduce the forces to which the vehicle occupants are subjected.

A seat belt can only provide the best level of protection if it is worn correctly. Depending on the detected accident situation, Emergency Tensioning Devices and/or airbags supplement the protection offered by a correctly worn seat belt. Emergency Tensioning Devices and/or airbags are not deployed in every accident.

In order for the restraint system to provide the intended level of protection, each vehicle occupant must observe the following information:

- Fasten seat belts correctly.
- Sit in an almost upright seat position with their back against the seat backrest.
- Sit with their feet resting on the floor, if possible.
- Always secure persons under 5 ft (1.50 m) tall in an additional restraint system suitable for Mercedes-Benz vehicles.

However, no system available today can completely eliminate injuries and fatalities in every accident situation. In particular, the seat belt and airbag generally do not protect against objects penetrating the vehicle from the outside. It is also not possible to completely rule out the risk of injury caused by the airbag deploying.

### Limitations of the protection provided by the restraint system

**⚠ WARNING** Risk of injury or death due to modifications to the restraint system

Vehicle occupants may no longer be protected as intended if alterations are made to the restraint system.

- ▶ Never alter the parts of the restraint system.
- ▶ Never tamper with the wiring or any electronic component parts or their software.

If it is necessary to modify the vehicle to accommodate a person with disabilities, contact an authorized Mercedes-Benz Center for details.



USA only: for details, contact our Customer Assistance Center on 1-800-FOR-MERCEdes (1-800-367-6372).

### Restraint system functionality

When the ignition is switched on, a self-test is performed, during which the  restraint system warning lamp lights up. It goes out no later than a few seconds after the vehicle is started. The components of the restraint system are then functional.

### Malfunctioning restraint system

A malfunction has occurred in the restraint system if:

- The  restraint system warning lamp does not light up when the vehicle is switched on
- The  restraint system warning lamp lights up continuously or repeatedly during a journey

**⚠ WARNING** Risk of injury due to malfunctions in the restraint system

Components in the restraint system may be activated unintentionally or not deploy as planned in an accident.

▶ Have the restraint system checked and repaired immediately at a qualified specialist workshop.

### Function of the restraint system in an accident

How the restraint system works depends on the severity of the impact detected and the apparent type of accident:

- Frontal impact
- Rear impact
- Side impact
- Rollover

The activation thresholds for the components of the restraint system are determined based on the evaluation of the sensor values measured at various points in the vehicle. This process is pre-emptive in nature. The triggering/deployment of the components of the restraint system must take place in good time at the start of the collision.

Factors that can be seen and measured only after a collision has occurred cannot play a decisive

role in air bag deployment, nor do they provide an indication of air bag deployment.

The vehicle may be deformed significantly without an air bag being deployed. This is the case if only parts that are relatively easily deformed are affected and the rate of vehicle deceleration is not high. Conversely, an air bag may be deployed even though the vehicle suffers only minor deformation. If very rigid vehicle parts such as longitudinal members are hit, this may result in sufficiently high levels of vehicle deceleration.

Depending on the detected deployment situation, the components of the restraint system can be activated or deployed independently of each other:

- Emergency Tensioning Device: frontal impact, rear impact, side impact, rollover
- Driver's airbag, front passenger airbag: frontal impact
- Knee airbag: frontal impact
- Side airbag: side impact
- Window airbag: side impact, rollover, frontal impact

The front passenger air bag can be deployed in an accident only if the PASSENGER AIR BAG OFF indicator lamp is off. If the front passenger seat is occupied, make sure, both before and during the journey, that the status of the front passenger air bag is correct (→ page 47).

**⚠ WARNING** Risk of burns from hot air bag components

The air bag parts are hot after an air bag has been deployed.

- ▶ Do not touch the air bag parts.
- ▶ Have a deployed air bag replaced at a qualified specialist workshop as soon as possible.

Mercedes-Benz recommends that you have the vehicle towed to a qualified specialist workshop after an accident. Take this into account, particularly if a Emergency Tensioning Device is triggered or an air bag deployed.

If the Emergency Tensioning Devices are triggered or an air bag is deployed, you will hear a bang, and a small amount of powder may also be released:

- The bang will not generally affect your hearing.
- In general, the powder released is not hazardous to health but may cause short-term breathing difficulties to persons suffering from asthma or other pulmonary conditions.

Provided it is safe to do so, leave the vehicle immediately or open the window in order to prevent breathing difficulties.

Air bags and pyrotechnic Emergency Tensioning Devices contain perchlorate material, which may require special handling or environmental protection measures. National guidelines regarding waste disposal must be observed. In California, see <https://dtsc.ca.gov/>. Using the search function, you will find information on perchlorate, for example.

## Seat belts

### Protection provided by the seat belt

Always fasten your seat belt correctly before starting a journey. A seat belt can provide the best level of protection only if it is worn correctly.

**⚠ WARNING** Risk of injury or death due to incorrectly fastened seat belt

If the seat belt is not worn correctly, it cannot perform its intended protective function.

In addition, an incorrectly fastened seat belt can also cause injuries, for example, in the event of an accident or when braking or changing direction suddenly.

- ▶ Always ensure that all vehicle occupants have their seat belts fastened correctly and are sitting properly.

Always observe the instructions about the correct driver's seat position and adjusting the seat (→ page 86).



In order for the correctly worn seat belt to provide the intended level of protection, each vehicle occupant must observe the following information:

- The seat belt must not be twisted and must fit tightly and snugly across the body.
- The seat belt must be routed across the center of the shoulder and as low down across the hips as possible.
- The shoulder section of the seat belt should not touch your neck nor be routed under your arm or behind your back.
- Avoid wearing bulky clothing, e.g. a winter coat.
- Push the lap belt down as far as possible across your hips and pull tight with the shoulder section of the belt. Never route the lap belt across your abdomen.  
Pregnant women must also take particular care with this.
- Never route the seat belt across sharp, pointed, abrasive or fragile objects.
- Only one person should use each seat belt at any one time.

- Never secure objects with a seat belt if the seat belt is also being used by one of the vehicle's occupants.

Also ensure that no objects, e.g. a cushion, are ever placed between a person and the seat.

The seat belts on the following seats are equipped with a child seat safety feature:

- Front passenger seat
- Rear seats

Activate or deactivate the child seat safety feature of the seat belt (→ page 55).

If children are traveling in the vehicle, be sure to observe the instructions and safety notes on "Children in the vehicle" (→ page 52).

Always observe the instructions for loading the vehicle when securing objects, luggage or loads (→ page 99).

### Limitations of the protection provided by the seat belt

**⚠ WARNING** Risk of injury or death due to an incorrect seat position

The seat belt does not offer the intended level of protection if you have not moved the seat backrest to an almost vertical position.

In particular, you could slip beneath the seat-belt and become injured.

- ▶ Adjust the seat properly before beginning your journey.
- ▶ Always ensure that the seat backrest is in an almost vertical position and that the shoulder belt is routed across the center of your shoulder.

**⚠ WARNING** Risk of injury or death due to an extended seat belt extender while the vehicle is in motion

If the seat belt does not sit correctly on the body, it cannot perform its intended protective function.

- ▶ Always ensure that the seat belt extender is retracted while the vehicle is in motion.

If the seat belt extender does not retract automatically, it can be retracted manually. To do so, press the seat belt extender back as far as it will go before starting the vehicle. Pressing the seat belt extender back into place requires force.

**⚠ WARNING** Risk of injury or death when additional restraint systems are not used for persons with a smaller stature

Persons under 5 ft (1.50 m) tall cannot wear the seat belt correctly without a suitable additional restraint system.

- ▶ Always secure persons under 5 ft (1.50 m) tall in a suitable restraint system.

**⚠ WARNING** Risk of injury or death due to damaged or modified seat belts

Seat belts cannot provide protection in the following situations:

- The seat belt is damaged, has been modified, is extremely dirty, bleached or dyed
- The seat belt buckle is damaged or extremely dirty
- Modifications have been made to the Emergency Tensioning Device, seat belt anchorage or seat belt retractor

Seat belts may sustain non-visible damage in an accident, e.g. due to glass splinters.

Modified or damaged seat belts could tear or fail in the event of an accident, for example.

Modified Emergency Tensioning Devices could accidentally trigger or fail to function as intended.

- ▶ Never modify the seat belt system, for example the seat belt, seat belt buckle, Emergency Tensioning Device, seat belt anchorage and seat belt retractor.

- ▶ Make sure that the seat belts are undamaged, not worn and clean.
- ▶ Always have the seat belts checked immediately after an accident at a qualified specialist workshop.

Only use seat belts which have been approved for your vehicle by Mercedes-Benz.

**⚠ WARNING** Risk of injury or death from deployed pyrotechnic Emergency Tensioning Devices

Pyrotechnic Emergency Tensioning Devices that have been deployed are no longer operational and are unable to perform their intended protective function.

- ▶ Therefore, have deployed pyrotechnic Emergency Tensioning Devices immediately replaced at a qualified specialist workshop.

Mercedes-Benz recommends that you have the vehicle towed to a qualified specialist workshop after an accident.

**!** **NOTE** Damage caused by trapping the seat belt

If an unused seat belt is not fully retracted, it may become trapped in the door or in the seat mechanism.

- ▶ Always ensure that an unused seat belt is fully retracted.

### Extending/retracting the seat belt extender

When the door is closed, the seat belt extender extends.

You can also extend the seat-belt extender by using the  seat-belt extender button in the center console.

The  seat belt extender button may also be located in the switch panel above the light switch in Mercedes-AMG vehicles.

- ▶ Switch on the ignition.
- ▶ Press the  seat belt extender button. The seat belt extender extends.

The seat belt extender retracts again in the following cases:

- The seat belt tongue is engaged in the seat belt buckle
- The seat belt tongue is not engaged in the seat belt buckle within 60 seconds

If you press the  seat belt extender button again in this case, the seat belt extender will extend again.

- The respective door is opened
  - You fold the seat backrest forwards
  - Nobody is sitting in the front passenger seat
- If you press the  seat belt extender button again in this case, the seat belt extender will no longer extend.

The seat belt extender must always be retracted while the vehicle is in motion.

### Fastening seat belts

If the seat belt is pulled quickly or sharply, the seat belt retractor locks. The seat belt strap cannot be pulled out any further.



- ▶ Always engage seat belt tongue **2** of the seat belt into seat belt buckle **1** of the corresponding seat.

**i** A seat belt can only provide the best level of protection if it is worn correctly. Observe the notes on fastening the seat belt (→ page 38).

**!** **NOTE** Deployment of components of the restraint system when the front passenger seat is unoccupied and a seat belt is buckled

When the front passenger seat is unoccupied and the seat belt tongue of the seat belt is engaged in the seat belt buckle, components of the restraint system may deploy unnecessarily on the front passenger side, e.g. the Emergency Tensioning Device.

▶ Only buckle the seat belts as intended.

- i** Observe the notes on storage areas (→ page 99). Information on installing a child restraint system and on children traveling in the vehicle can be found in the "Children in the vehicle" section (→ page 55).

### Seat belt adjustment function

**Vehicles with PRE-SAFE®:** after a front seat belt has been fastened, the automatic seat belt adjustment may apply a certain amount of tightening

force. Do not hold the seat belt tightly while it is adjusting.

You can activate and deactivate the seat belt adjustment function using the multimedia system (→ page 42).

### Activating/deactivating seat belt adjustment via the multimedia system

Multimedia system:

➤ Vehicle ▶  Vehicle Settings

➤➤ Belt Adjustment

▶ Activate  or deactivate  the function.

### Releasing seat belts

▶ Press the release button in the seat belt buckle and guide the seat belt back with the seat belt tongue.

### Seat belt warning function for the driver and front passenger

The  seat belt warning lamp on the instrument display is a reminder that all vehicle occupants must wear their seat belts correctly.

The  seat belt warning lamp will light up for six seconds every time the vehicle is started.

In addition, a warning tone may sound.

When the driver's and front passenger's doors are closed and the driver and front passenger have fastened their seat belts, the seat belt warning will go out.

In the following cases, the seat belt warning will light up during a journey if:

- The vehicle speed exceeds 15 mph (25 km/h) and the driver's or front passenger seat belt is not fastened.
- The driver or front passenger unfastens his or her seat belt while the vehicle is in motion.

## Airbags

### Overview of airbags

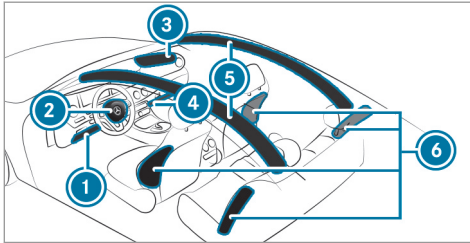

- ① Driver's knee airbag
- ② Driver's airbag
- ③ Front passenger airbag
- ④ Front passenger knee airbag
- ⑤ Window curtain airbag
- ⑥ Side airbag

The installation location of an airbag is identified by the AIRBAG symbol.

When enabled, an airbag can provide additional protection for the respective vehicle occupant.

Potential protection provided by each airbag:

- Knee airbag: thigh, knee and lower leg
- Driver's airbag, front passenger airbag: head and ribcage
- Window curtain airbag: head
- Side airbag: ribcage, also pelvis for front seat occupants

#### ! NOTE Mercedes-AMG vehicles

- ▶ Observe the notes in the Supplement. You could otherwise fail to recognize dangers.

#### ! WARNING Risk of injury or death if the co-driver airbag is enabled

If the co-driver airbag is enabled, a child on the co-driver seat may be struck by the co-driver airbag during an accident.

NEVER use a rearward-facing child restraint system on a seat with an ENABLED FRONT AIRBAG; DEATH or SERIOUS INJURY to the CHILD can occur.

When installing a child restraint system on the front passenger seat, observe the vehicle-specific information (→ page 60). Also, always observe the notes on rearward-facing or forward-facing child restraint systems on the front passenger seat.

#### Information on automatic front passenger airbag shutoff

The front passenger airbag can only be deployed in an accident if the PASSENGER AIR BAG OFF indicator lamp is off. If the front passenger seat is occupied, make sure, both before and during the journey, that the status of the front passenger airbag is correct (→ page 47).

#### ! NOTE Deployment of components of the restraint system when the front passenger seat is unoccupied

In an accident, the components of the restraint system may deploy unnecessarily on the front passenger side if:

- There are heavy objects on the front passenger seat.

- The seat belt tongue is engaged in the seat belt buckle of the front passenger seat and the front passenger seat is unoccupied.
- ▶ Store objects in a suitable place.
- ▶ Only one person should use each seat belt at any one time.

Depending on the detected accident situation, the window curtain airbag on the front passenger side may deploy. The airbag is deployed regardless of whether the front passenger seat is occupied.

### Protection provided by the airbags

Depending on the accident situation, an airbag may supplement the protection offered by a correctly fastened seat belt.

**▲ WARNING** Risk of injury or death due to an incorrect seat position

If you deviate from the correct seat position, the airbag cannot perform its intended protective function.

Each vehicle occupant must make sure of the following:

- Fasten seat belts correctly. Pregnant women must take particular care to ensure that the lap belt never lies across the abdomen.
- Adopt the correct seat position and keep as far away as possible from the airbags.
- Observe the following information.
- ▶ Always make sure that there are no objects between the airbag and vehicle occupant.

To avoid the risks resulting from the deployment of an airbag, each vehicle occupant must observe the following information in particular:

- Before starting your journey, adjust your seat correctly; the driver's seat and front passenger seat should be moved as far back as possible.
- When doing so, always observe the information on the correct driver's seat position (→ page 86).

- Only hold the steering wheel by the steering wheel rim. This allows the airbag to be fully deployed.
- Always lean against the seat backrest when the vehicle is in motion. Do not lean forwards or against the door or side window. You may otherwise be in the deployment area of the airbags.
- The occupants must always keep their feet on the floor. Do not put your feet on the cockpit, for example. Your feet may otherwise be in the deployment area of the airbag.
- If children are traveling in the vehicle, observe the additional notes (→ page 52).
- Always stow and secure objects correctly.

Objects in the vehicle interior may prevent an airbag from functioning correctly. Each vehicle occupant must always make sure of the following in particular:

- There are no people, animals or objects between the vehicle occupants and an airbag.
- There are no objects between the seat, door and door pillar (B-pillar).

- There are no hard objects, e.g. coat hangers, hanging on the grab handles or coat hooks.
- There are no accessories, such as mobile navigation devices, mobile phones or cup holders, within the deployment area of an airbag, e.g. on the cockpit, on the door, on the side window or on the side trim.

In addition, no connecting cables, tensioning straps or retaining straps must be routed or attached to the vehicle within the deployment area of an airbag. Always comply with the accessory manufacturer's installation instructions and, in particular, the notes on suitable places for installation.

- There are no heavy, sharp-edged or fragile objects in the pockets of your clothing. Store such objects in a suitable place.

### Limitations of the protection provided by airbags

#### **⚠ WARNING** Risk of injury due to modifications to the cover of an airbag

If you change the cover of an airbag or attach objects, e.g. even stickers, to it, the airbag may no longer function as intended.

- ▶ Never modify the cover of an airbag.
- ▶ Do not attach any objects to the cover.

The installation location of an airbag is identified by the AIRBAG symbol (→ page 43).

Objects in the deployment area of an airbag may prevent the airbag from functioning correctly.

#### **⚠ WARNING** Risk of injury from objects in the deployment area of an airbag

Objects in the deployment area of an airbag can hinder or prevent the correct deployment of the airbag.

The airbag may then deploy in an uncontrolled manner and may even cause additional injuries to the vehicle occupants by deploying.

This may be the case in particular if the airbag is integrated into the seat.

- ▶ Always stow and secure objects correctly.
- ▶ Before commencing your journey, make sure that no objects are stowed in the deployment area of an airbag.

#### **⚠ WARNING** Risk of injury or death due to the use of unsuitable seat covers

Due to unsuitable seat covers, the airbags cannot protect vehicle occupants as intended.

In addition, the operation of the automatic front passenger airbag shutoff could be restricted.

- ▶ You should only use seat covers that have been approved for the corresponding seats by Mercedes-Benz.

**▲ WARNING** Risk of injury due to malfunctioning sensors in the door

The function of the airbags can be impaired due to modifications or incorrect work performed on the doors or door trim, or if the doors are damaged.

- ▶ Never modify the doors or parts of the doors.
- ▶ Always have work on the doors or door trim carried out at a qualified specialist workshop.

**▲ WARNING** Risk of injury due to deployed airbag

A deployed airbag no longer offers any protection.

- ▶ Have the vehicle towed to a qualified specialist workshop in order to have the deployed airbag replaced.

Have deployed airbags replaced immediately.

### Status of the front passenger front airbag

#### **Function of the automatic front passenger air bag deactivation system**

The automatic front passenger air bag deactivation system is able to detect whether the front passenger seat is occupied by a person or a child restraint system. The front passenger air bag and front passenger knee air bag will be activated or deactivated accordingly.

**▲ WARNING** Risk of injury or death due to objects under the co-driver seat

Objects trapped under the co-driver seat can interfere with the function of the automatic co-driver airbag shutoff or damage the system.

- ▶ Do not store any objects under the co-driver seat.
- ▶ When the co-driver seat is occupied, make sure that no objects are trapped under the co-driver seat.

When installing a child restraint system on the front passenger seat, observe the vehicle-specific information (→ page 61). Also, always observe

the notes on rearward-facing or forward-facing child restraint systems on the front passenger seat (→ page 60).

A person on the front passenger seat must observe the following information:

- Fasten the seat belt correctly (→ page 38).
- Sit in an almost upright seat position with your back against the seat backrest.
- Sit with your feet resting on the floor, if possible.

The front passenger air bag may otherwise be deactivated by mistake, for example, in the following situations:

- The front passenger transfers his or her weight by supporting himself or herself on a vehicle armrest.
- The front passenger sits in such a way that his or her weight is raised off the seat surface.



**⚠ WARNING** Risk of injury or death due to a disabled front passenger airbag

The front passenger airbag is disabled when the PASSENGER AIR BAG OFF indicator lamp is lit.

A person in the front passenger seat could then, for example, come into contact with the vehicle interior, especially if the person is sitting too close to the cockpit.

If the front passenger seat is occupied, always ensure that:

- The classification of the person in the front passenger seat is correct and the front passenger airbag is enabled or disabled in accordance with the person in the front passenger seat.
  - The front passenger seat has been moved as far back as possible.
  - The person is seated correctly.
- ▶ Both before and during the journey, ensure that the status of the front passenger airbag is correct.

If the front passenger seat is occupied, the classification of the person or child restraint system on the front passenger seat will take place after the front passenger air bag deactivation system self-test. The PASSENGER AIR BAG indicator lamps display the status of the front passenger air bag.

Always observe the notes on the function of the PASSENGER AIR BAG indicator lamps (→ page 47).

**Function of the PASSENGER AIR BAG indicator lamps**

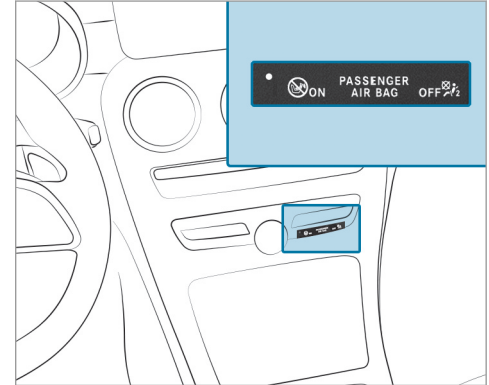

**Self-test of automatic front passenger airbag shut-off**

When the ignition is switched on, a self-test is performed during which the two PASSENGER AIR BAG ON and OFF indicator lamps light up simultaneously.

The status of the front passenger airbag is displayed via the PASSENGER AIR BAG indicator lamps after the self-test:

- **ON is lit:** the front passenger airbag may deploy during an accident.  
The indicator lamp goes out after 60 seconds.
- **ON and OFF are not lit:** the front passenger airbag may deploy during an accident.
- **OFF is lit:** the front passenger airbag is disabled. It will then not be deployed in the event of an accident.

If the PASSENGER AIR BAG ON indicator lamp is off, only the PASSENGER AIR BAG OFF indicator lamp shows the status of the front passenger airbag. The PASSENGER AIR BAG OFF indicator lamp may be lit continuously or be off.

If the PASSENGER AIR BAG OFF indicator lamp and the  restraint system warning lamp light up simultaneously, the front passenger seat may not be used. Also in this case, do not install a child restraint system on the front passenger seat. Have the automatic front passenger airbag

shutoff checked and repaired immediately at a qualified specialist workshop.

#### Status display

If the front passenger seat is occupied, ensure, both before and during the journey, that the status of the front passenger airbag is correct for the current situation.

**After installing a rearward-facing child restraint system on the front passenger seat:** PASSENGER AIR BAG OFF must be lit continuously.

**⚠ WARNING** Risk of injury or fatal injury when using a rearward-facing child restraint system while the co-driver airbag is enabled

If you secure a child in a rearward-facing child restraint system on the co-driver seat and the PASSENGER AIR BAG OFF indicator lamp is off, the co-driver airbag can deploy in the event of an accident.

The child could be struck by the airbag.

- ▶ Always ensure that the co-driver airbag is disabled. The PASSENGER AIR BAG OFF indicator lamp must be lit.
- ▶ NEVER use a rearward-facing child restraint system on a seat with an ENABLED FRONT AIRBAG; DEATH or SERIOUS INJURY to the CHILD can occur.

When installing a child restraint system on the front passenger seat, observe the vehicle-specific information (→ page 60).

Depending on the child restraint system and the stature of the child, the PASSENGER AIR BAG OFF indicator lamp may be off. In this case, do not install the rearward-facing child restraint system on the front passenger seat.

Instead, install the rearward-facing child restraint system on a suitable rear seat.

**After installing a forward-facing child restraint system on the front passenger seat:** depending on the child restraint system and the stature of the child, PASSENGER AIR BAG OFF may be lit continuously or be off. Always observe the following information.

**▲ WARNING** Risk of injury or death due to incorrect positioning of the forward-facing child restraint system

If you secure a child in a forward-facing child restraint system on the front passenger seat that is positioned too close to the cockpit, in the event of an accident, the child could:

- come into contact with parts of the vehicle's interior if the PASSENGER AIR BAG OFF indicator lamp is lit, for example
  - be struck by the airbag if the PASSENGER AIR BAG OFF indicator lamp is off
- ▶ Always move the front passenger seat as far back as possible and fully retract the seat cushion length adjustment. While doing so, always make sure that the shoulder belt strap is correctly routed from the seat belt outlet of the vehicle to the shoulder belt guide on the child restraint system. The shoulder belt strap must be routed forwards and downwards from the seat belt outlet. If necessary,

adjust the front passenger seat accordingly.

- ▶ Always comply with the child restraint system manufacturer's installation instructions.

When installing a child restraint system on the front passenger seat, observe the vehicle-specific information (→ page 60).

**If a person is sitting on the front passenger seat:** PASSENGER AIR BAG OFF may be lit continuously or be off, depending on the person's stature.

A person on the front passenger seat must always observe the following information:

- If the front passenger seat is occupied by an adult or a person with a stature corresponding to that of an adult, the PASSENGER AIR BAG OFF indicator lamp must be off. This indicates that the front passenger airbag is enabled. If the PASSENGER AIR BAG OFF indicator lamp is lit continuously, an adult or person with a build corresponding to that of an adult must not use the front passenger seat. Instead, they should use a rear seat.

- If the front passenger seat is occupied by a person of smaller stature (e.g. a teenager or small adult), the PASSENGER AIR BAG OFF indicator lamp is either lit continuously or remains off, depending on the classification.
  - If the PASSENGER AIR BAG OFF indicator lamp is off: move the front passenger seat as far back as possible, or the person of smaller stature should use a rear seat.
  - If the PASSENGER AIR BAG OFF indicator lamp is lit continuously: the person of smaller stature should not use the front passenger seat.

**▲ WARNING** Risk of injury or death when the PASSENGER AIR BAG OFF indicator lamp is lit

If the PASSENGER AIR BAG OFF indicator lamp remains lit after the self-test, the front passenger airbag is disabled.

If the front passenger seat is occupied, always ensure that:

- The classification of the person in the front passenger seat is correct and the front passenger airbag is enabled or disabled in accordance with the person in the front passenger seat.
- The person is seated properly with a correctly fastened seat belt.
- The front passenger seat has been moved as far back as possible.

Be sure to also observe the following further related subjects:

- Child restraint system on the front passenger seat (→ page 60)

## PRE-SAFE® system

### Function of PRE-SAFE® (anticipatory occupant protection)

PRE-SAFE® is able to detect certain critical driving situations and implement pre-emptive measures to protect the vehicle occupants.

PRE-SAFE® can implement the following measures independently of each other:

- Tightening the seat belts on the driver's seat and front passenger seat.
- Closing the side windows.
- **Vehicles with sliding sunroof:** closing the sliding sunroof.
- **Vehicles with memory function:** moving the front passenger seat to a more favorable seat position.
- **Vehicles with multicontour seat:** increasing the air pressure in the seat side bolsters of the seat backrest.
- PRE-SAFE® Sound: provided that the multimedia system is switched on, generating a brief

audible signal to stimulate the innate protective mechanism of a person's hearing.

**!** **NOTE** Damage caused by objects in the footwell or behind the seat

The automatic adjustment of the seat position may result in damage to the seat and/or the object.

▶ Stow objects in a suitable place.

### Reverting the PRE-SAFE® system measures

If an accident did not occur, the pre-emptive measures that were taken will be reversed.

You will need to perform certain settings yourself.

▶ If the seat belt pre-tensioning is not reduced, move the seat backrest back slightly. The locking mechanism will release.

### Function of PRE-SAFE® PLUS (anticipatory occupant protection plus)

PRE-SAFE® PLUS can detect certain impacts, particularly an imminent rear impact, and take pre-

emptive measures to protect the vehicle occupants. These measures cannot necessarily prevent an imminent impact.

PRE-SAFE® PLUS can implement the following measures independently of each other:

- Tightening the seat belts on the driver's seat and front passenger seat.
- Increasing brake pressure when the vehicle is stationary. Brake application will be canceled automatically when the vehicle pulls away.

If an accident did not occur, the pre-emptive measures that were taken will be reversed.

### System limits

The system will not initiate any action in the following situations:

- when backing up

The system will not initiate any braking application in the following situations:

- whilst driving
- or

- when entering or exiting a parking space while using Active Parking Assist

### Safely transporting children in the vehicle

#### To be observed at all times when children are traveling in the vehicle

- ① Also strictly observe the safety notes for the specific situation. That way, you can recognize potential risks and avoid dangers if children are traveling in the vehicle (→ page 52).

#### Be diligent

Bear in mind that negligence when securing a child in the child restraint system may have serious consequences. Always be diligent in securing a child carefully before every journey.

Never allow a baby or child to travel sitting on the lap of another vehicle occupant.

To improve protection for children younger than 12 years old or under 5 ft (1.50 m) in height, Mercedes-Benz recommends you observe the following information:

- Always secure the child in a child restraint system suitable for this Mercedes-Benz vehicle.
- The child restraint system must be appropriate to the age, weight and size of the child.
- The vehicle seat must be suitable for installing a child restraint system.

Accident statistics show that children secured on the rear seats are generally safer than children secured on the front seats. For this reason, Mercedes-Benz strongly advises that you install a child restraint system on a rear seat.

#### The generic term child restraint system

The generic term "child restraint system" is used in this Operator's Manual. A child restraint system is, for example:

- a baby car seat
- a rearward-facing child seat
- a forward-facing child seat

- a child booster seat with a backrest and seat belt guide

Mercedes-Benz recommends using a child booster seat with a backrest.

The child restraint system must be appropriate to the age, weight and size of the child.

### Observe laws and legal requirements

Always observe the legal requirements when using a child restraint system in the vehicle.

### Observe standards for child restraint systems

All child restraint systems must meet the following standards:

- U.S. Federal Motor Vehicle Safety Standards 213 and 225
- Canadian Motor Vehicle Safety Standards 213 and 210.2

Confirmation that the child restraint system complies with the standards can be found on an instruction label on the child restraint system. This confirmation can also be found in the installation instructions that are included with the child restraint system.

### Detecting risks, avoiding danger

#### Securing systems for child restraint systems in the vehicle

Use only the following securing systems for child restraint systems:

- the ISOFIX securing rings
- the vehicle's seat belt system
- the Top Tether anchorages

Installing an ISOFIX child restraint system is preferred.

Simply attaching to the securing rings on the vehicle can reduce the risk of installing the child restraint system incorrectly.

When securing a child with the integrated seat belt of the ISOFIX child restraint system, always comply with the permissible gross weight for the child and child restraint system (→ page 56).

A booster seat may be necessary to achieve proper seat belt positioning for children over 40 lbs (18 kg) in weight or up to a height at which a three-point seat belt can be installed properly without a booster seat.

Mercedes-Benz recommends a suitable child booster seat with a backrest and seat belt guide.

#### Advantage of a rearward-facing child restraint system

It is preferable to transport a baby or a small child in a suitable rearward-facing child restraint system. In this case, the child sits in the opposite direction to the direction of travel and faces backwards.

Babies and small children have comparatively weak neck muscles in relation to the size and weight of their heads. The risk of injury to the cervical spine during an accident can be reduced in a rearward-facing child restraint system.

#### Always secure a child restraint system correctly

**⚠ WARNING** Risk of injury or death due to incorrect installation of the child restraint system

The child can then not be protected or restrained as intended.

- ▶ Be sure to comply with the manufacturer's installation instructions for the child restraint system and its correct use.
- ▶ Make sure that the entire base of the child restraint system always rests on the sitting surface of the seat.
- ▶ Never place objects (e.g. cushions) under or behind the child restraint system.
- ▶ Use child restraint systems only with the original cover designed for them.
- ▶ Always replace damaged covers with genuine covers.

**⚠ WARNING** Risk of injury or death due to unsecured child restraint systems in the vehicle

If the child restraint system is incorrectly installed or not secured, it can come loose. The child restraint system could be flung around and hit vehicle occupants.

- ▶ Always install child restraint systems correctly, even when not in use.
  - ▶ Always comply with the child restraint system manufacturer's installation instructions.
- Always observe the child restraint system manufacturer's installation and operating instructions as well as the vehicle-specific information:
    - Installing the ISOFIX child restraint system on the right and left rear seats (→ page 56).
    - Securing the child restraint system with the seat belt on the rear seat (→ page 59).
    - Securing the child restraint system with the seat belt on the front passenger seat (→ page 61). Observe the specific instructions for the rearward-facing and forward-facing child restraint systems (→ page 60).
- If the front passenger seat is occupied, ensure, both before and during the jour-

ney, that the status of the front passenger air bag is correct for the current situation (→ page 47).

- Observe the warning labels in the vehicle interior and on the child restraint system.
- Also secure Top Tether if present.

#### Do not modify the child restraint system

**⚠ WARNING** Risk of injury due to modifications to the child restraint system

The child restraint system can no longer function properly. This poses an increased risk of injury.

- ▶ Never modify a child restraint system.
- ▶ Only affix accessories which have been specially approved for this child restraint system by the child restraint system's manufacturer.

### Use only child restraint systems that are in proper working condition

**⚠ WARNING** Risk of injury or death caused by the use of damaged child restraint systems

Child restraint systems or their retaining systems that have been subjected to stress in an accident may not be able to perform their intended protective function.

It may be the case that the child cannot be properly restrained.

- ▶ Always immediately replace child restraint systems that have been damaged or involved in an accident.
- ▶ Have the securing systems for the child restraint systems checked at a qualified specialist workshop before installing a child restraint system again.

### Avoid direct sunlight

**⚠ WARNING** Risk of burns when the child seat is exposed to direct sunlight

If the child restraint system is exposed to direct sunlight or heat, parts could heat up excessively.

Children could suffer burns from these parts, particularly the metallic parts of the child restraint system.

- ▶ Always make sure that the child restraint system is not exposed to direct sunlight.
- ▶ Cover the child restraint system with a blanket, for example.
- ▶ If the child restraint system has been exposed to direct sunlight, allow it to cool before securing a child into it.
- ▶ Never leave children unattended in the vehicle.

### Note when stopping or parking

**⚠ WARNING** Risk of accident and injury due to children left unattended in the vehicle

If children are left unsupervised in the vehicle, they could, in particular:

- open doors, thereby endangering other persons or road users.
- get out and be struck by oncoming traffic.
- operate vehicle equipment and become trapped, for example.

In addition, the children could also set the vehicle in motion, for example by:

- releasing the parking brake.
- changing the transmission position.
- starting the vehicle.
- ▶ Never leave children unattended in the vehicle.
- ▶ When leaving the vehicle, always take the SmartKey with you and lock the vehicle.



- ▶ Keep the vehicle SmartKey out of reach of children.

**⚠ WARNING** Risk of fatal injury due to exposure to extreme heat or cold in the vehicle

If persons, particularly children, are subjected to prolonged exposure to intense heat or cold, there is a risk of severe injury or even death.

- ▶ Never leave persons, particularly children, unattended in the vehicle.

### Overview of suitable seats in the vehicle for installing a child restraint system

#### Left/right rear seat

Preferred securing system:



ISOFIX child seat anchor



Also secure Top Tether if present (→ page 58).

Alternative securing system:



Vehicle seat belt

#### Front passenger seat

Securing system:



Vehicle seat belt

Please note:

- If the front passenger seat is occupied, ensure, both before and during the journey, that the status of the front passenger air bag is correct for the current situation (→ page 47).
- Notes on the automatic front passenger air bag deactivation system (→ page 46).

#### Activating or deactivating the special seat belt retractor of the seat belt



**WARNING** Risk of injury or death if a seat belt is unfastened while the vehicle is in motion

If the seat belt is released while the vehicle is in motion, the special seat belt retractor is deactivated and the child restraint system is no longer correctly secured. The seat belt is

drawn in slightly by the inertia reel and cannot be immediately closed again.

- ▶ Stop the vehicle immediately in accordance with the traffic conditions.
- ▶ Activate the special seat belt retractor again and correctly secure the child restraint system.

When enabled, the special seat belt retractor ensures that the seat belts of the front passenger seat and rear seats do not slacken once the child restraint system is secured.

The seat belts on the following seats are equipped with a special seat belt retractor:

- Front passenger seat
- Rear seats

#### Installing a child restraint system

- ▶ When installing a child restraint system, always observe the manufacturer's installation and operating instructions as well as the information in this Operator's Manual.

- ▶ Pull the seat belt smoothly from the seat belt outlet.
- ▶ Engage the seat belt tongue in the seat belt buckle.

#### Activating the special seat belt retractor

- ▶ Pull the seat belt out fully and let the inertia reel retract it again. When the special seat belt retractor is activated, you will hear a ratcheting sound.
- ▶ Push the child restraint system down until the seat belt sits tightly.

#### Deactivating the special seat belt retractor

- ▶ Press the release button of the seat belt buckle.
- ▶ Hold the seat belt tongue and guide back to the seat belt outlet.

#### Installing a LATCH-type (ISOFIX) child restraint system on the left and right rear seats

#### Installing an ISOFIX child restraint system on the left and right rear seats

**⚠ WARNING** Risk of accident if the rear bench seat, rear seat and seat backrest are not engaged

The rear bench seat, rear seat and seat backrest may fold forwards, even when you are driving.

- As a result, the vehicle occupant will be pushed into the seat belt with increased force. The seat belt will not be able to protect as intended and could cause additional injury.
  - Objects or loads in the trunk or cargo compartment will not be restrained by the seat backrest.
- ▶ Make sure that the rear bench seat, the rear seat and the seat backrest are engaged before every trip.

If the left and right seat backrests are not engaged and locked in place, this will be shown on the display on the instrument display.

If the center seat backrest is not engaged and locked in place, the red lock verification indicator will be visible.

**⚠ WARNING** Risk of injury or death if the permissible gross mass of the child and child restraint system together is exceeded.

Too much load may be placed on the LATCH-type (ISOFIX) child restraint system and the child may not be restrained correctly in the event of an accident, for example.

- ▶ If the child and the child restraint system together weigh more than the permissible gross mass of 73 lb (33 kg), only use a LATCH-type (ISOFIX) child restraint system with which the child is secured with the vehicle seat belt.
- ▶ Also secure the child restraint system with the Top Tether belt, if available.

Always comply with the specifications regarding the weight of the child restraint system:

- In the manufacturer's installation and operating instructions for the child restraint system used
- On a label on the child restraint system, if present

Regularly check that the weight of the child and child restraint system still complies with the permissible gross weight.

When installing a child restraint system, observe the following:

- ✓ Always ensure that the installation area and the seats are suitable for attaching a child restraint system.
- ✓ Always comply with the manufacturer's installation and operating instructions for the child restraint system used.
- ✓ Make sure that the child's feet do not touch the front seat. If necessary, move the front seat slightly forwards.

 When installing an ISOFIX child restraint system, also observe the following:

- ✓ **When using a baby car seat in weight group 0/0+ and a rearward-facing child restraint system in Weight group I on a rear seat:** adjust the front seat so that the seat does not touch the child restraint system.
- ✓ **When using a forward-facing child restraint system in Weight group I:** remove the head restraint from the respective seat, if possible. In addition, the backrest on the child restraint system must lie as flat as possible against the backrest on the vehicle seat. After the child restraint system has been removed, replace the head restraint immediately and adjust all head restraints correctly.
- ✓ If the head restraint of the child seat cannot be fully extended when it is installed in the vehicle, this will result in restrictions on the maximum size setting for child restraint systems in weight group II or III. Contact with the roof when the head restraint is fully extended and locked in place will not result in any restrictions on use.

- ✓ Ensure that the child restraint system is not subjected to strain between the roof and the seat cushion and/or installed facing the wrong direction. Where possible, adjust the seat cushion inclination accordingly.
- ✓ Ensure that the child restraint system is not subjected to strain by the head restraint. Adjust the head restraints as appropriate.

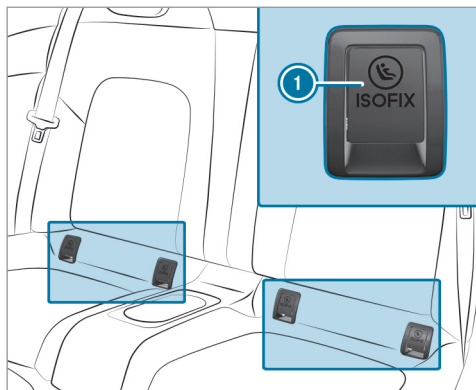

### 1 ISOFIX mounting bracket

Before every journey, make sure that the ISOFIX child restraint system is engaged correctly in both mounting brackets in the vehicle.

- ▶ Attach the ISOFIX child restraint system to both mounting brackets in the vehicle.

### Fastening a Top Tether

**⚠ WARNING** Risk of injury or death if the rear seat backrests are not locked after Top Tether belts are installed

The rear seat backrests may fold forwards when you are driving.

As a result, child restraint systems will no longer be able to perform their intended protective function. This may also cause additional injuries.

- ▶ Always lock rear seat backrests after installing Top Tether belts.
- ▶ Observe the lock verification indicator.

If the left and right seat backrests are not engaged and locked in place, this will be shown on the display on the instrument display.

If the center seat backrest is not engaged and locked in place, the red lock verification indicator will be visible.



If the child restraint system is equipped with a Top Tether belt:

The risk of injury may be reduced by Top Tether. The Top Tether belt enables an additional connection between the child restraint system attached with LATCH-type (ISOFIX) (left and right rear seats) or the seat belt (all rear seats) and the vehicle.

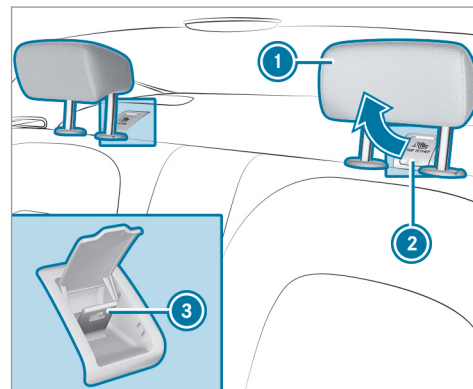

- ▶ If necessary, slide head restraint 1 upwards (→ page 91).

- ▶ Fold up cover ② of Top Tether anchorage ③.
- ▶ Install the LATCH-type (ISOFIX) or belt-secured child restraint system with Top Tether. In doing so, comply with the child restraint system manufacturer's installation instructions.

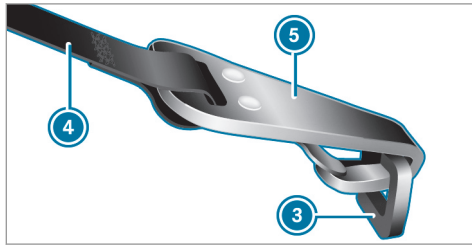

- ▶ Guide Top Tether belt ④ under head restraint ① between the two head restraint bars.
- ▶ Hook Top Tether hook ⑤ of Top Tether belt ④ into Top Tether anchorage ③ without twisting.

- ▶ Tension Top Tether belt ④. In doing so, comply with the child restraint system manufacturer's installation instructions.
- ▶ Fold down cover ② of Top Tether anchorage ③.
- ▶ If necessary, slide head restraint ① downwards (→ page 91). Make sure that you do not interfere with the correct routing of Top Tether belt ④.

### Securing the child restraint system with the seat belt

#### Securing the child restraint system with the seat belt on the rear seat

**⚠ WARNING** Risk of accident if the rear bench seat, rear seat and seat backrest are not engaged

The rear bench seat, rear seat and seat backrest may fold forwards, even when you are driving.

- As a result, the vehicle occupant will be pushed into the seat belt with increased force. The seat belt will not be able to protect as intended and could cause additional injury.
  - Objects or loads in the trunk or cargo compartment will not be restrained by the seat backrest.
- ▶ Make sure that the rear bench seat, the rear seat and the seat backrest are engaged before every trip.

If the left and right seat backrests are not engaged and locked in place, this will be shown on the instrument display.

If the center seat backrest is not engaged and locked in place, the red lock verification indicator will be visible.

#### When installing a belt-secured child restraint system, observe the following:

- ☑ Always comply with the manufacturer's installation and operating instructions for the child restraint system used.

- ✓ **When using a weight group 0/0+ baby car seat and a weight group 1 rearward-facing child restraint system on a rear seat:** adjust the front seat so that the seat does not touch the child restraint system.
- ✓ **When using a weight group 1 forward-facing child restraint system:** remove the head restraint from the respective seat, if possible. After the child restraint system has been removed, replace the head restraint immediately and adjust all head restraints correctly.
- ✓ The backrest of the forward-facing child restraint system must, as far as possible, be resting on the seat backrest of the rear seat.
- ✓ If the head restraint of the child seat cannot be fully extended when it is installed in the vehicle, this will result in restrictions on the maximum size setting for child restraint systems in weight group 2 or 3.  
Contact with the roof when the head restraint is fully extended and locked in place will not result in any restrictions on use.
- ✓ The child restraint system must not be put under strain between the roof and the seat

cushion and/or be installed facing the wrong direction. Where possible, adjust the seat cushion inclination accordingly.

- ✓ The child restraint system must not be put under strain by the head restraint. Adjust the head restraints as appropriate.
- ✓ Make sure that the child's feet do not touch the front seat. If necessary, move the front seat slightly forwards.

The seat belts on the following seats are equipped with a child seat safety feature:

- Front passenger seat
- Rear seats

When enabled, the child seat safety feature ensures that the seat belts of the front passenger seat and rear seats do not slacken once the child restraint system is secured (→ page 55).

- ▶ Install the child restraint system. The entire base of the child restraint system must always rest on the surface of the rear seat.
- ▶ Always make sure that the shoulder belt strap is correctly routed from the seat belt outlet of

the vehicle to the shoulder belt guide on the child restraint system.

The shoulder belt strap must be routed forward from the seat belt outlet.

#### Notes on rearward-facing and forward-facing child restraint systems on the front passenger seat

**▲ WARNING** Risk of injury or fatal injury when using a rearward-facing child restraint system while the co-driver airbag is enabled

If you secure a child in a rearward-facing child restraint system on the co-driver seat and the PASSENGER AIR BAG OFF indicator lamp is off, the co-driver airbag can deploy in the event of an accident.

The child could be struck by the airbag.

- ▶ Always ensure that the co-driver airbag is disabled. The PASSENGER AIR BAG OFF indicator lamp must be lit.
- ▶ NEVER use a rearward-facing child restraint system on a seat with an ENA-

DISABLED FRONT AIRBAG; DEATH or SERIOUS INJURY to the CHILD can occur.

Observe the specific instructions for the rearward-facing and forward-facing child restraint systems (→ page 61).

Always observe the status of the front passenger air bag on the PASSENGER AIR BAG OFF indicator lamp:

- When using a rearward-facing child restraint system on the front passenger seat, the front passenger air bag must always be deactivated. This is the case only if the PASSENGER AIR BAG OFF indicator lamp is lit continuously (→ page 47).
- If the PASSENGER AIR BAG OFF indicator lamp is off, the front passenger air bag is activated. The front passenger air bag may deploy during an accident.

### Securing the child restraint system with the seat belt on the front passenger seat

When installing a belt-secured child restraint system on the front passenger seat, always observe the following:

- ✓ Observe the notes on rearward-facing and forward-facing child restraint systems on the front passenger seat (→ page 60).
- ✓ Observe the child restraint system manufacturer's installation and operating instructions.
- ✓ When using a forward-facing child restraint system in weight group 1: remove the head restraint from the respective seat, if possible. After the child restraint system has been removed, replace the head restraint immediately and adjust all head restraints correctly.
- ✓ The backrest of the forward-facing child restraint system must, as far as possible, be resting on the seat backrest of the front passenger seat.
- ✓ If the head restraint of the child seat cannot be fully extended when it is installed in the vehicle, this will result in restrictions on the

maximum size setting for child restraint systems in weight group 2 or 3.

Contact with the roof when the head restraint is fully extended and locked in place will not result in any restrictions on use.

- ✓ The child restraint system must not be put under strain between the roof and the seat cushion and/or be installed facing the wrong direction.
- ✓ The child restraint system must not be put under strain by the head restraint. Adjust the head restraints as appropriate.
- ✓ Never place objects (e.g. cushions) under or behind the child restraint system.

The seat belt on the front passenger side is equipped with a child seat safety feature.

When enabled, the child seat safety feature ensures that the seat belt does not slacken once the child seat is secured (→ page 55).

**⚠ WARNING** Risk of injury or death due to objects between the seat surface and the child restraint system

Objects between the seat surface and the child restraint system could affect the function of the automatic front passenger airbag shut-off.

- ▶ Do not place any objects between the seat surface and the child restraint system.
- ▶ Always make sure that the child restraint system is correctly installed.

- ▶ Set the front passenger seat as far back as possible and move the seat into the highest position if possible.
- ▶ Fully retract the seat cushion length adjustment.
- ▶ Adjust the seat cushion inclination such that the front edge of the seat cushion is in the highest position and the rear edge of the seat cushion is in the lowest position.

- ▶ Set the seat backrest to the most vertical position possible.
- ▶ Install the child restraint system. The entire base of the child restraint system must always rest on the seat surface of the front passenger seat.
- ▶ Always make sure that the shoulder belt strap is correctly routed from the seat belt outlet of the vehicle to the shoulder belt guide on the child restraint system. The shoulder belt strap must be routed forwards and downwards from the seat belt outlet.
- ▶ If necessary, adjust the seat belt outlet and the front passenger seat accordingly.

#### Notes on pets in the vehicle

**⚠ WARNING** Risk of accident and injury due to animals left unsecured or unattended in the vehicle

If you leave animals in the vehicle unattended or unsecured, they could possibly press buttons or switches.

An animal may:

- Activate vehicle equipment and become trapped, for example
- Switch systems on or off and endanger other road users

Unsecured animals may be thrown around in the vehicle in the event of an accident or sudden steering and braking maneuvers and injure vehicle occupants in the process.

- ▶ Never leave animals in the vehicle unattended.
- ▶ Always correctly secure animals while driving, e.g. using a suitable animal carrier.



## SmartKey

### Overview of key functions

**⚠ WARNING** Risk of accident and injury due to children left unattended in the vehicle

If children are left unsupervised in the vehicle, they could, in particular:

- open doors, thereby endangering other persons or road users.
- get out and be struck by oncoming traffic.
- operate vehicle equipment and become trapped, for example.

In addition, the children could also set the vehicle in motion, for example by:

- releasing the parking brake.
- changing the transmission position.
- starting the vehicle.

▶ Never leave children unattended in the vehicle.

- ▶ When leaving the vehicle, always take the SmartKey with you and lock the vehicle.
- ▶ Keep the vehicle SmartKey out of reach of children.

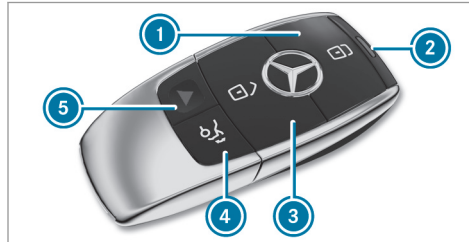

**⚠ NOTE** Damage to the SmartKey caused by magnetic fields

- ▶ Keep the SmartKey away from strong magnetic fields.



Vehicle key with panic alarm

- ① To lock
- ② Indicator lamp

- ③ Unlocks
  - ④ Opens/closes the trunk lid
  - ⑤ Panic alarm
- ⓘ If indicator lamp ② does not light up after pressing the  or  button, the battery is weak or possibly discharged. Replace the battery as soon as possible.

Replace the key battery (→ page 65).

The key locks and unlocks the following components:

- Doors
- Fuel filler flap
- Trunk lid

If the vehicle is not opened within approximately 40 seconds after unlocking, it locks again. Anti-theft protection is activated again.

Do not keep the key together with electronic devices or metal objects. This can affect the key's functionality.

### Activating/deactivating the acoustic locking verification signal

Multimedia system:

→ Vehicle →  Vehicle Settings

→ Acoustic Lock

▶ Activate  or deactivate  the function.

### Arming/disarming the panic alarm

#### Requirements:

- The vehicle is switched off.



▶ **To activate:** press button ① for approximately one second.

A visual and audible alarm is triggered.

▶ **To deactivate:** briefly press button ① again.

or



▶ Press the start/stop button.

A SmartKey belonging to the vehicle must be detected in the vehicle.

### Changing the unlocking settings

Possible unlocking functions of the SmartKey:

- Central unlocking
- Unlocking the driver's door and fuel filler flap

▶ **To switch between settings:** press the  and  buttons simultaneously for approximately six seconds until the indicator lamp flashes twice.

Options when the unlocking function for the driver's door and fuel filler flap has been selected:

- **To unlock the vehicle centrally:** press the  button twice.



- **Vehicles with KEYLESS-GO:** if you touch the inner surface of the door handle on the driver's door, only the driver's door and the fuel filler flap will be unlocked.

### Deactivating the function of the key

**Vehicles with KEYLESS-GO:** if you deactivate the function of the key, the KEYLESS-GO functions are also deactivated. Access or drive authorization by KEYLESS-GO is then no longer possible with that particular key. Activate the function of the key so that all its functions will again be available.

You can also deactivate the function of the key to reduce the energy consumption of the key if you do not use the vehicle or a key for an extended period of time.

▶ **Deactivate:** Press  and hold the key button.

▶ With the key pressed,  immediately press the key button  twice in quick succession.

The indicator light of the key lights up once briefly and once for a long time.

- ▶ **To activate:** press any button on the key.
- ❗ When the vehicle is started with the key in the stowage compartment of the center console, the function of the key is automatically activated (→ page 130).

### Removing/inserting the emergency key

#### Removing the emergency key

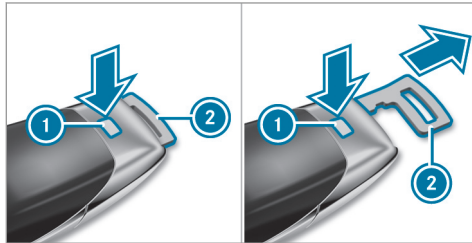

- ▶ Press release button ①.
- ▶ Emergency key ② will be pushed out slightly.
- ▶ Pull out emergency key ② until it engages in the intermediate position.

- ▶ Press release button ① again and fully remove emergency key ②.

#### Inserting the emergency key

- ▶ Press release button ①.
- ▶ Insert emergency key ② to the intermediate position or fully until it engages.
- ❗ You can use the intermediate position of emergency key ② to attach the SmartKey to a key ring.

#### Replacing the SmartKey battery

**⚠ DANGER** Risk of fatal injuries due to swallowing batteries

Batteries contain toxic and corrosive substances. Swallowing batteries may cause severe internal burns to occur within two hours.

There is a risk of fatal injury.

- ▶ Keep batteries out of the reach of children.
- ▶ If the cap and/or the battery compartment does not close securely, do not use

the SmartKey any longer and keep out of the reach of children.

- ▶ If batteries are swallowed, seek medical attention immediately.

**🔥 ENVIRONMENTAL NOTE** Environmental damage due to improper disposal of batteries



Batteries contain pollutants. It is illegal to dispose of them with the household rubbish.



Dispose of batteries in an environmentally responsible manner. Take discharged batteries to a qualified specialist workshop or to a collection point for used batteries.

**Requirements**

- You require a CR 2032 3 V cell battery.

Mercedes-Benz recommends that you have the battery replaced at a qualified specialist workshop.

- Remove the emergency key (→ page 65).

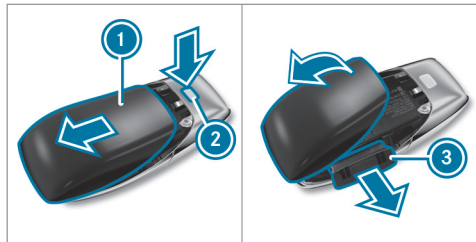

- Press release button ② down fully and slide cover ① in the direction of the arrow.
- Lift up cover ① in the direction of the arrow and remove it.
- Remove battery compartment ③ and take out the discharged battery.

- Insert the new battery into battery compartment ③. Observe the positive pole marking in the battery compartment and on the battery when doing this.
- Push in battery compartment ③.
- Re-attach cover ① and push it closed until it engages.

**Problems with the SmartKey, troubleshooting****You can no longer lock or unlock the vehicle**

Possible causes:

- The SmartKey battery is weak or discharged.
- Check the battery using the indicator lamp (→ page 63).
- Replace the SmartKey battery, if necessary (→ page 65).
- Use the replacement key.
- Use the emergency key to lock or unlock (→ page 69).
- Have the SmartKey checked at a qualified specialist workshop.

**There is interference from a powerful radio signal source**

Possible causes if the function of the SmartKey is impaired:

- high voltage power lines
- mobile phones
- electronic devices (notebooks, tablets)
- shielding due to metallic objects or induction loops for electrical gate systems or automatic barriers
- Make sure that there is sufficient distance between the SmartKey and the potential source of interference.

**You have lost a SmartKey.**

- Have the SmartKey deactivated at a qualified specialist workshop.
- If necessary, have the mechanical lock replaced as well.

## Doors

## Unlocking and opening doors from the inside

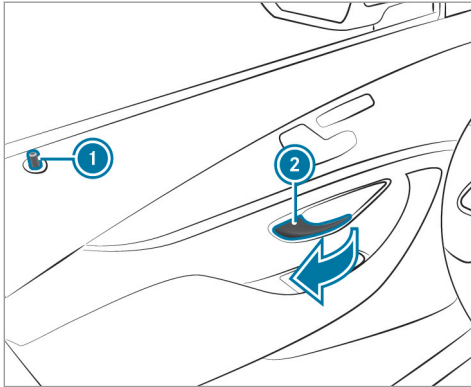

- ▶ Pull door handle ②.
- ▶ Locking pin ① pops up when the door is unlocked.

## Centrally locking and unlocking the vehicle from the inside

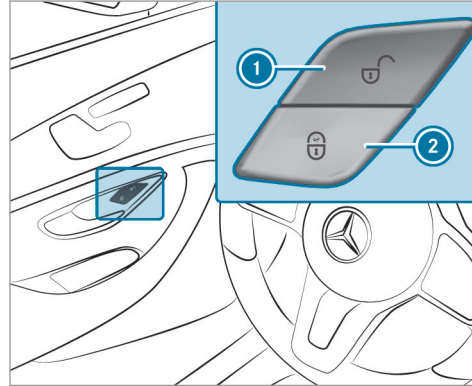

- ▶ **To unlock:** press button ①.
- ▶ **To lock:** press button ②.

ⓘ The buttons are also located on the front passenger door.

This does not lock or unlock the fuel filler flap.

The vehicle is not unlocked:

- if you have locked the vehicle using the SmartKey
- if you have locked the vehicle using KEYLESS-GO

## Locking/unlocking the vehicle with KEYLESS-GO

## Requirements

- The SmartKey is outside the vehicle.
- The distance between the SmartKey and the vehicle does not exceed 3 ft (1 m).
- The driver's door and the door on which the door handle is operated are closed.

**!** **NOTE** Damage to the vehicle caused by unintentionally opening the trunk lid

- When using an automatic car wash
- When using a high pressure cleaner

▶ Deactivate the function of the SmartKey in these situations.

or

- ▶ Make sure that the SmartKey is at a minimum distance of 10 ft (3 m) away from the vehicle.

Observe the notes:

- on washing the vehicle in a car wash (→ page 328)
- on using a high-pressure cleaner (→ page 329)

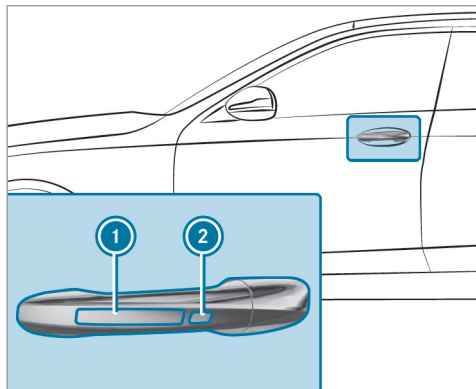

- ▶ **To unlock the vehicle:** touch the inner surface of the door handle.
- ▶ **To lock the vehicle:** touch sensor surface ① or ②.
- ▶ **Convenience closing:** touch recessed sensor surface ② until the closing process has been completed.
- ① Further information on convenience closing (→ page 77).

If you open the trunk lid from outside, the trunk lid is automatically unlocked.

### Problems with KEYLESS-GO, troubleshooting

**You can no longer lock or unlock the vehicle using KEYLESS-GO**

Possible causes:

- The function of the SmartKey has been deactivated.
  - The SmartKey battery is weak or discharged.
- ▶ Activate the function of the SmartKey (→ page 64).

- ▶ Check the battery using the indicator lamp (→ page 63).
- ▶ Replace the SmartKey battery, if necessary (→ page 65).
- ▶ Use the replacement SmartKey.
- ▶ Use the emergency key to lock or unlock (→ page 69).
- ▶ Have the vehicle and SmartKey checked at a qualified specialist workshop.

**There is interference from a powerful radio signal source**

Possible causes if the function of KEYLESS-GO is impaired:

- High voltage power lines
  - Mobile phones
  - Electronic devices (notebooks, tablets)
  - Shielding due to metal objects or induction loops for electrical gate systems or automatic barriers
- ▶ Make sure that there is sufficient distance between the SmartKey and the potential source of interference.

### Activating/deactivating the automatic locking feature

The vehicle is locked automatically when the vehicle is switched on and the wheels are turning faster than walking pace.

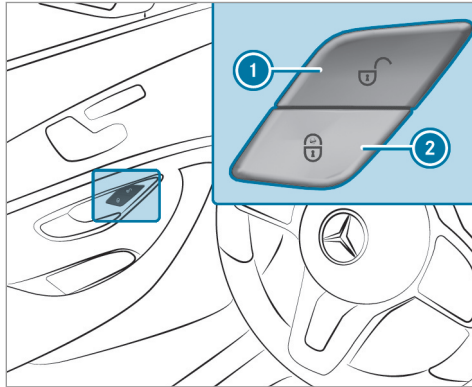

▶ **To activate:** press and hold button ② for approximately five seconds until an acoustic signal sounds.

▶ **To deactivate:** press and hold button ① for approximately five seconds until an acoustic signal sounds.

In the following situations, there is a danger of being locked out when the function is activated:

- while the vehicle is being tow-started or pushed
- if the vehicle is being tested on a roller dynamometer

### Locking/unlocking the driver's door with the emergency key

① If you wish to lock the vehicle entirely using the emergency key, first press the button for locking from the inside while the driver's door is open. Then proceed to lock the driver's door using the emergency key.

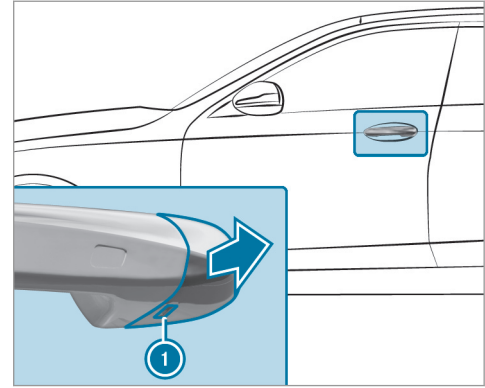

- ▶ Remove the emergency key (→ page 65).
- ▶ Insert the emergency key as far as it will go into opening ① in the cover.
- ▶ Pull and hold the door handle.
- ▶ Pull the cover on the emergency key as straight as possible away from the vehicle until it releases.
- ▶ Release the door handle.

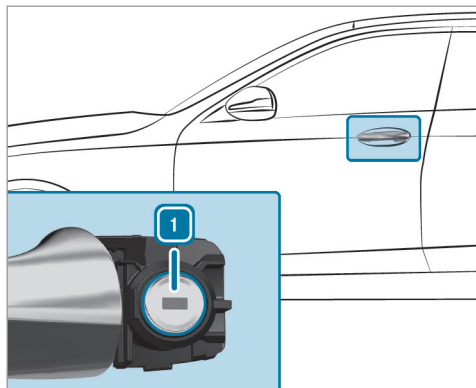

- ▶ **To unlock:** turn the emergency key counter-clockwise to position 1.
- ▶ **To lock:** turn the emergency key clockwise to position 1.
- ▶ Carefully press the cover onto the lock cylinder until it engages and is seated firmly.

## Trunk

### Opening the trunk lid

**⚠ DANGER** Risk of exhaust gas poisoning

Combustion engines emit poisonous exhaust gases such as carbon monoxide. Exhaust gases can enter the vehicle interior if the trunk lid is open when the engine is running, especially if the vehicle is in motion.

- ▶ Always switch off the engine before opening the trunk lid.
- ▶ Never drive with the trunk lid open.

**! NOTE** Damage to the trunk lid by obstacles above the vehicle

The trunk lid swings upwards when it is opened.

- ▶ Therefore, make sure that there is sufficient clearance above the trunk lid.

- ▶ **Vehicles with HANDS-FREE ACCESS:** make a kicking movement with your foot below the bumper (→ page 73).

### Vehicles with trunk lid convenience closing

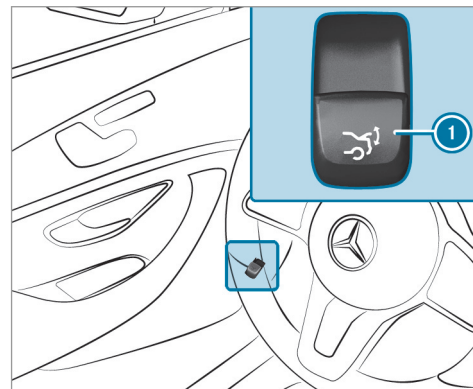

- ▶ Pull remote operating switch 1 until the trunk lid opens.

or

- ▶ Press and hold the  button on the SmartKey.



- ▶ If the trunk lid is stopped in an intermediate position, pull it upwards. Release it as soon as it begins to open.
- ▶ With the trunk lid opening height restriction activated, manually pull the stopped trunk lid upwards.

If an obstacle obstructs the trunk lid during the automatic opening process, blockage detection will stop the trunk lid. The automatic blockage detection function is only an aid and is not a substitute for your attentiveness.

### Closing the trunk lid

**⚠ WARNING** Risk of injury from unsecured items in the vehicle

If objects, luggage or loads are not secured or not secured sufficiently, they could slip, tip over or be thrown around and thereby hit vehicle occupants.

There is a risk of injury, particularly in the event of sudden braking or a sudden change in direction.

- ▶ Always stow objects in such a way that they cannot be thrown around.
- ▶ Before the journey, secure objects, luggage or loads against slipping or tipping over.

Observe the notes on loading the vehicle.

**Notes on closing the trunk lid:** your vehicle is equipped with automatic SmartKey recognition. If a SmartKey belonging to the vehicle is detected in the vehicle, the trunk lid will not be locked and will pop open again.

Note that the trunk lid will not be locked if the following situation occurs:

- You have locked the vehicle and close the trunk lid while a SmartKey belonging to the vehicle is inside the vehicle.
- and
- A second SmartKey belonging to the vehicle is not detected outside the vehicle.

Automatic SmartKey recognition is only an aid and is not a substitute for your attentiveness.

- ▶ Before locking, ensure that at least one SmartKey belonging to the vehicle is outside the vehicle.
- ▶ **To close the trunk lid:** pull the trunk lid downwards using the handle recess and push it closed.

### Vehicles with trunk lid convenience closing

**⚠ WARNING** Risk of becoming trapped during automatic closing of the trunk lid

Parts of the body could become trapped. There may be people in the closing area.

- ▶ Make sure that nobody is in the vicinity of the closing area during the closing process.
- ▶ Use one of the following options to stop the closing process:
  - Press the  button on the SmartKey.
  - Press or pull the remote operating switch on the driver's door.
  - Press the closing or locking button on the trunk lid.

**Vehicles with HANDS-FREE ACCESS:** it is also possible to stop the closing process by making a kicking movement below the rear bumper.

- ▶ **To close the trunk lid:** pull the trunk lid downwards using the handle recess and push it closed.
- ▶ If the trunk lid is stopped in an intermediate position, push it downwards. The trunk lid will continue to close.

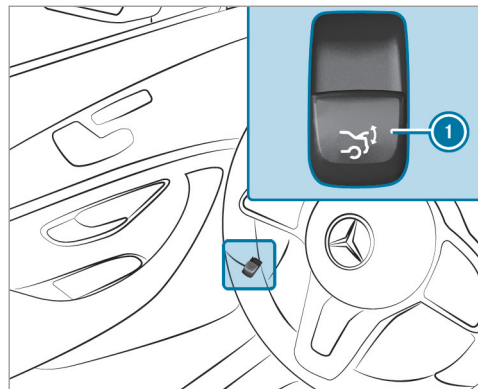

- ▶ Push remote operating switch ① until the trunk lid is fully closed.

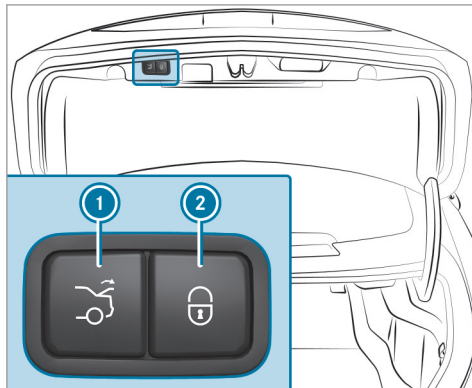

- ▶ Press closing button ① on the trunk lid.

### Vehicles with KEYLESS-GO

- ▶ Press locking button ② on the trunk lid. If a SmartKey is detected outside the vehicle, the trunk lid will close and the vehicle will be locked.
- ▶ With the trunk lid completely open, press and hold the  button on the SmartKey. The SmartKey must be in the vicinity of the vehicle.

### Vehicles with HANDS-FREE ACCESS

- ▶ With the trunk lid completely open, make a kicking movement with your foot below the bumper (→ page 73).

### Trunk lid automatic reversing function

The trunk lid is equipped with automatic blockage detection with a reversing function. If an obstacle obstructs the trunk lid during the automatic closing process, it will automatically open again. The automatic reversing function is only an aid and is not a substitute for your attentiveness.

- ▶ During the closing process, make sure that no body parts are in the closing area.

**⚠ WARNING** Risk of becoming trapped despite reversing function

The reversing function will not react:

- to soft, light and thin objects, e.g. fingers
- towards the end of the closing procedure

In these situations in particular, the reversing function cannot prevent someone being trapped.

- ▶ Ensure that no body parts are in the closing area.

If someone is trapped:

- press the  button on the SmartKey, or
- press or pull the remote operating switch on the driver's door, or
- press the closing or locking button on the trunk lid.

### HANDS-FREE ACCESS function

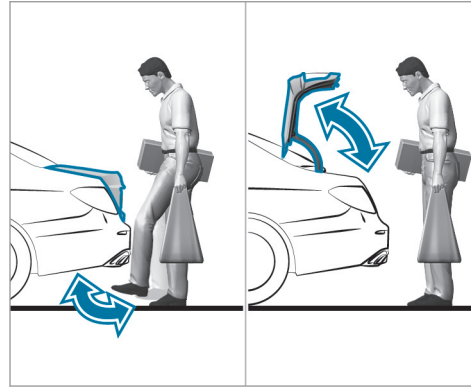

With HANDS-FREE ACCESS you can open, close or interrupt trunk lid movement by performing a kicking movement under the rear bumper.

The kicking movement triggers the opening or closing process alternately.

Observe the notes when opening (→ page 70) and closing (→ page 71) the trunk lid.

- ⓘ A warning tone sounds while the trunk lid is opening or closing.

**⚠ WARNING** Risk of burns caused by a hot exhaust system

The vehicle exhaust system can become very hot. If you use HANDS-FREE ACCESS, you could burn yourself by touching the exhaust system.

- ▶ Always ensure that you only make a kicking movement within the detection range of the sensors.

**! NOTE** Damage to the vehicle caused by unintentionally opening the trunk lid

- When using an automatic car wash
- When using a high pressure cleaner
- ▶ Deactivate the function of the SmartKey in these situations.

or

- ▶ Make sure that the SmartKey is at a minimum distance of 10 ft (3 m) away from the vehicle.

When making the kicking movement, make sure that you are standing firmly on the ground. You could otherwise lose your balance, e.g. on ice.

Observe the following notes:

- The key is behind the vehicle.
- Stand at least 12 in (30 cm) away from the vehicle while performing the kicking movement.
- Do not come into contact with the bumper while making the kicking movement.
- Do not carry out the kicking movement too slowly.
- The kicking movement must be towards the vehicle and back again.

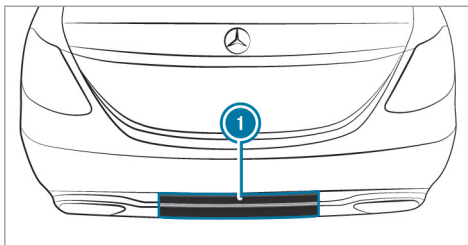

① Detection range of the sensors

If several consecutive kicking movements are not successful, wait ten seconds.

**System limits**

The system may be impaired or may not function in the following cases:

- The sensors are dirty, e.g. due to road salt or snow.
- The kicking movement is made using a prosthetic leg.

The trunk lid could be opened or closed unintentionally, in the following situations:

- A person's arms or legs are moving in the sensor detection range, e.g. when polishing the vehicle or picking up objects.
- Objects are moved or placed behind the vehicle, e.g. the hose of a fuel dispenser, a charging cable or luggage
- Clamping straps, tarp or other coverings are pulled over the bumper.
- A protective mat with a length reaching over the trunk sill down into the detection range of the sensors is used.
- The protective mat is not secured correctly.

Deactivate the function of the key (→ page 64) or do not carry the key about your person in such situations.

**Switching separate trunk locking on or off**

If you centrally unlock the vehicle while separate locking is activated, the trunk will remain locked.

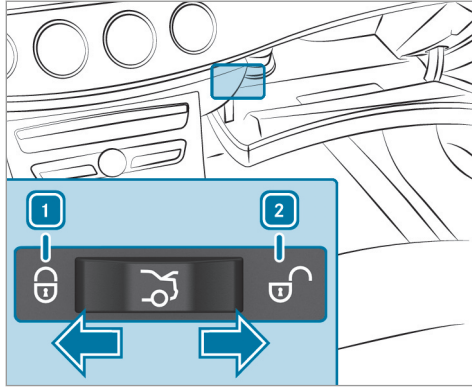

- ▶ **To switch on:** slide the switch to position **1**.
- ▶ **To switch off:** slide the switch to position **2**.
- i** If an accident has been detected, the trunk will unlock even if separate locking is switched on.

### Unlocking and opening the trunk from inside with the emergency release

#### Requirements:

- The 12 V vehicle battery is connected and charged.

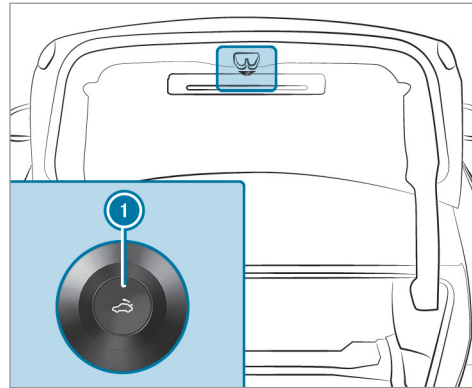

- ▶ Press the emergency release button **1** briefly.

### Activating/deactivating the trunk lid opening height restriction

Multimedia system:

- ▶ **Vehicle** ▶ **Vehicle Settings**
- ▶ **Trunk Lid Restriction**

This function allows you to avoid bumping the trunk lid on a low garage ceiling, for example.

- ▶ Activate  or deactivate  the function.

### Side windows

#### Opening and closing the side windows

**⚠ WARNING** Risk of entrapment when opening a side window

When opening a side window, parts of the body could be drawn in or become trapped between the side window and window frame.

- ▶ When opening, make sure that nobody is touching the side window.

- ▶ If someone is trapped, release the button immediately or pull it in order to close the side window again.

**⚠ WARNING** Risk of becoming trapped when closing a side window

When closing a side window, body parts could be trapped in the closing area in the process.

- ▶ When closing, make sure that no body parts are in the closing area.
- ▶ If someone is trapped, release the button immediately or press the button in order to reopen the side window.

**⚠ WARNING** Risk of becoming trapped when children operate the side windows

Children could become trapped if they operate the side windows, particularly when unattended.

- ▶ Never leave children unattended in the vehicle.

- ▶ When leaving the vehicle, always take the SmartKey with you and lock the vehicle.

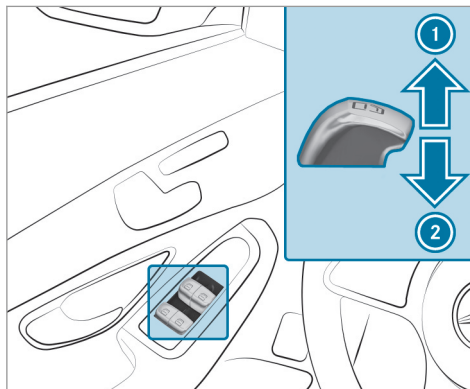

**Requirements**

- The power supply or vehicle has been switched on.



- ① Close
- ② Open

The buttons on the driver's door have priority.

- ▶ **To start automatic operation:** press the  button beyond the point of resistance or pull and release.
- ▶ **To interrupt automatic operation:** press or pull the  button again.

When the vehicle is switched off, you can continue to operate the side windows.

This function is available for approximately four minutes or until one of the doors is opened.

**Automatic side window reversing feature**

If an obstacle impedes a side window during the closing process, the side window will open again automatically. The automatic reversing feature is only an aid and is not a substitute for your attentiveness.

- ▶ During the closing process, make sure that no body parts are in the closing area.

**⚠ WARNING** Risk of becoming trapped despite there being reversing protection on the side window

The reversing function does not react:

- To soft, light and thin objects, e.g. fingers.
- During resetting.

The reversing function cannot prevent someone from becoming trapped in these situations.

- ▶ During the closing process, make sure that no body parts are in the closing area.
- ▶ If someone becomes trapped, press the  button to open the side window again.

### Convenience opening (ventilating the vehicle before starting a journey)

**⚠ WARNING** Risk of entrapment when opening a side window

When opening a side window, parts of the body could be drawn in or become trapped between the side window and window frame.

- ▶ When opening, make sure that nobody is touching the side window.
- ▶ Release the button immediately if somebody becomes trapped.

### Requirements



- The SmartKey is in the immediate vicinity of the vehicle.
- ▶ Press and hold the  button on the SmartKey.
 

The following functions will be performed:

  - The vehicle will be unlocked.
  - The side windows will be opened.
  - The panoramic sliding roof will be opened.

- The seat ventilation of the driver's seat will be switched on.

**i** If the roller sunblind of the panoramic sliding sunroof is closed, the roller sunblind will be opened first.

- ▶ **To interrupt convenience opening:** release the  button.
- ▶ **To continue convenience opening:** press and hold the  button again.

### Convenience closing (closing the vehicle from outside)

**⚠ WARNING** Risk of entrapment due to not paying attention during convenience closing

When the convenience closing feature is operating, parts of the body could become trapped in the closing area of the side window and the sliding sunroof.

- ▶ When the convenience closing feature is operating, monitor the entire closing

process and make sure that no body parts are in the closing area.

### Requirements

- The SmartKey is in the immediate vicinity of the vehicle.

▶ Press and hold the  button on the SmartKey.

The following functions will be performed:

- The vehicle will be locked.
- The side windows will be closed.
- The panoramic sliding sunroof will be closed.

▶ **To interrupt convenience closing:** release the  button.

▶ **To continue convenience closing:** press and hold the  button again.

ⓘ Convenience closing also functions with KEY-LESS-GO (→ page 67).

### Resolving problems with the side windows

**⚠ WARNING** Risk of becoming trapped or fatally injured if reversing protection is not activated

If you close a side window again immediately after it has been blocked, the side window will close with increased or maximum force. The reversing function is then not active and body parts may become trapped.

- ▶ Make sure that no parts of the body are in the closing area.
- ▶ To stop the closing process, release the button or press the button again to reopen the side window.

### One of the side windows cannot be closed and the cause is not obvious.

- ▶ Check to see whether any objects are in the window guide.
- ▶ Adjust the side windows.

### Adjusting the side windows

If a side window is obstructed during closing and reopens again immediately:

- ▶ Immediately after this, pull and hold the corresponding button again until the side window has closed and hold the button for at least one more second (readjustment). The side window will be closed without the automatic reversing feature.

If the side window is obstructed again and reopens again immediately:

- ▶ Immediately after this, pull and hold the corresponding button again until the side window has closed and hold the button for at least one more second (readjustment). The side window will be closed without the automatic reversing feature.

### The side windows cannot be opened or closed using the convenience opening feature.

Possible causes:

- The battery in the SmartKey is weak or discharged.



- ▶ Check the battery using the indicator lamp (→ page 63).
- ▶ Replace the SmartKey battery, if necessary (→ page 65).

### Sliding sunroof

#### Opening and closing the sliding sunroof

- ⓘ The term "sliding sunroof" also refers to the panorama roof with power tilt/sliding panel.

**⚠ WARNING** Risk of becoming trapped when the sliding sunroof is being opened and closed

Body parts may become trapped in the range of movement.

- ▶ During opening and closing, make sure that no body parts are in the range of movement.
- ▶ Release the button immediately if somebody becomes trapped.

or

- ▶ Briefly press the button in any direction during automatic operation. The opening or closing process will be stopped.

**⚠ WARNING** Risk of becoming trapped if the sliding sunroof is operated by children

Children operating the sliding sunroof could get caught in the moving parts, particularly if unattended.

- ▶ Never leave children unattended in the vehicle.
- ▶ When leaving the vehicle, always take the key with you and lock the vehicle.

**⚠ WARNING** Risk of becoming trapped when the roller sunblind is being opened and closed

Body parts may become trapped between the roller sunblind and frame or sliding roof.

- ▶ When opening or closing, make sure that no body parts are in the roller sunblind's range of movement.
- ▶ Release the button immediately if somebody becomes trapped.

or

- ▶ Briefly press the button in any direction during automatic operation. The opening or closing process will be stopped.

**! NOTE** Malfunction due to snow and ice

Snow and ice may cause the sliding sunroof to malfunction.

- ▶ Open the sliding sunroof only if it is free of snow and ice.

**! NOTE** Damage caused by protruding objects

Objects that protrude from the sliding sunroof may damage the seals.

- ▶ Do not allow anything to protrude from the sliding sunroof.

**!** **NOTE** Damage to the panorama roof with power tilt/sliding panel due to non-approved roof luggage racks

The panorama roof with power tilt/sliding panel may be damaged by the roof luggage rack if you attempt to open it when using a roof luggage rack not tested and approved for Mercedes-Benz.

- ▶ When a roof luggage rack is installed, open the panorama roof with power tilt/sliding panel only if this has been tested and approved for Mercedes-Benz.

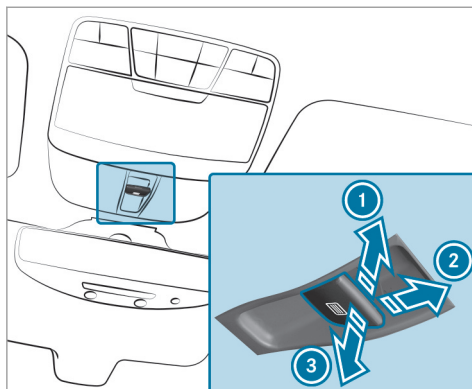

The panorama roof with power tilt/sliding panel may be raised to allow ventilation of the vehicle interior.



- 1 Raise
- 2 Opening
- 3 Close/lower

Use the  button to operate the panorama roof with power tilt/sliding panel and the roller sunblind.

The panorama roof with power tilt/sliding panel can be operated only when the roller sunblind is open.

- ▶ Check whether the sliding sunroof can be raised or opened when a roof luggage rack is installed.
- ▶ **To start automatic operation:** press the  button beyond the point of resistance or pull and release it.
- ▶ **To interrupt automatic operation:** briefly press the  button in any direction. The opening/closing process will be stopped.

**Vehicles with a panorama roof with power tilt/sliding panel:** the automatic raising feature is available only when the sliding sunroof is closed or raised.

#### Automatic reversing function of the sliding sunroof

If an obstacle obstructs the sliding sunroof during the closing process, the sliding sunroof will open again automatically. The automatic reversing function is only an aid and is not a substitute for your attentiveness.

- ▶ During the closing process, make sure that no body parts are in the closing area.

**⚠ WARNING** Risk of becoming trapped despite the reversing function being active

In particular, the reversing function does not react:

- To soft, light and thin objects, e.g. fingers.
- Towards the end of the closing procedure.
- During resetting.

- ▶ During the closing process, make sure that no body parts are in the closing area.
- ▶ Release the button immediately if somebody becomes trapped.

or

- ▶ Briefly press the button in any direction during automatic operation.  
The closing process will be stopped.

**Automatic reversing function of the roller sunblind**

If an obstacle obstructs the roller sunblind during the closing process, the roller sunblind will open

again automatically. The automatic reversing function is only an aid and is not a substitute for your attentiveness.

- ▶ When closing the roller sunblind, make sure that no body parts are in the range of movement.

**⚠ WARNING** Risk of becoming trapped despite reversing function

In particular, the reversing function does not react to soft, light and thin objects, e.g. fingers.

- ▶ When closing the roller sunblind, make sure that no body parts are in the range of movement.
- ▶ Release the button immediately if somebody becomes trapped.

or

- ▶ Briefly press the button in any direction during the automatic closing process.  
The closing process will be stopped.

**Automatic functions of the sliding sunroof**

- ⓘ The term "sliding sunroof" also refers to the panoramic sliding sunroof.

**Rain closing function when driving**

**Vehicles with a panoramic sliding sunroof:** if it starts to rain, the raised sliding sunroof will automatically be lowered while the vehicle is in motion.

**Automatic lowering function**

**Vehicles with a panoramic sliding sunroof:** if the sliding sunroof is raised at the rear, it will automatically be lowered slightly at higher speeds. At low speeds, it will be raised again automatically.

**⚠ WARNING** Risk of becoming trapped by automatic lowering of the sliding sunroof

At higher speeds, the raised sliding sunroof will automatically be lowered slightly at the rear.

- ▶ Make sure that nobody reaches into the sliding sunroof's range of movement while the vehicle is in motion.

- ▶ If somebody becomes trapped, briefly push the sliding sunroof button forwards or backwards.

**i** By pushing or pulling the  button, you can interrupt the automatic functions "Rain closing function when driving" and "Automatic lowering".

### Rectifying problems with the sliding sunroof

**▲ WARNING** Risk of becoming trapped or fatal injuries when the sliding sunroof is closed again

If the sliding sunroof is closed again immediately after it has been blocked or reset, it will close with increased force.

- ▶ Make sure that no parts of the body are in the closing area.
- ▶ Release the button immediately if somebody becomes trapped.

or

- ▶ Briefly press the button in any direction during the automatic closing process. The closing process will be stopped.

**The sliding sunroof cannot be closed and you cannot see the cause.**

**i** The term "sliding sunroof" also refers to the panorama roof with power tilt/sliding panel.

If the sliding sunroof is obstructed during closing and reopens again slightly:

- ▶ Immediately after automatic reversing, pull and hold the  button down again to the point of resistance until the sliding sunroof is closed. The sliding sunroof will be closed with increased force.



If the sliding sunroof is obstructed again and opens again slightly:

- ▶ Repeat the previous step. The sliding sunroof will be closed again with increased force.

**Vehicles with a panorama roof with power tilt/sliding panel: The sliding sunroof or the roller sunblind is not operating smoothly.**

- ▶ Reset the sliding sunroof and the roller sunblind.

**Resetting the sliding sunroof and the roller sunblind**

- ▶ Pull and hold the  button little by little until the sliding sunroof is fully closed.
- ▶ Pull and hold the  button little by little until the roller sunblind is fully closed.
- ▶ Use automatic operation to fully open and then close the sliding sunroof.

### Anti-theft protection

#### Function of the immobilizer

The immobilizer prevents your vehicle from being started without the correct SmartKey.

The immobilizer is automatically activated when the vehicle is switched off, and deactivated when the vehicle is switched on.

When leaving the vehicle, always take the SmartKey with you and lock the vehicle. Anyone can start the vehicle if a valid SmartKey has been left inside the vehicle.

- ❗ In the event the engine cannot be started (yet the vehicle's battery is charged), the system is not operational. Contact an authorized Mercedes-Benz Center or call 1-800-FOR-MERCEdes (in the USA) or 1-800-387-0100 (in Canada).

### ATA (anti-theft alarm system)

#### Function of the ATA system

If the ATA system is armed, a visual and audible alarm is triggered in the following situations:

- when a door is opened
- when the trunk lid is opened
- when the hood is opened
- when interior protection is triggered (→ page 84)
- when the tow-away alarm is triggered (→ page 84)

The ATA system is armed automatically after approximately ten seconds in the following situations:

- after the vehicle is locked with the SmartKey
- after the vehicle is locked using KEYLESS-GO

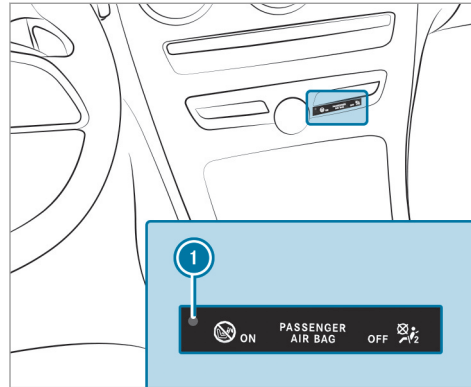

Indicator lamp ❶ flashes when the ATA system is armed.

The ATA system is deactivated automatically in the following situations:

- after the vehicle is unlocked with the SmartKey
- after the vehicle is unlocked using KEYLESS-GO
- after the start/stop button is pressed with the SmartKey in the stowage compartment (→ page 130)
- ❗ When the Mercedes-Benz emergency call system is active and the alarm stays on for more than 30 seconds, a message is automatically sent to the customer center (→ page 293).
- ❗ In the case of severe battery discharging, the anti-theft alarm system is automatically deactivated to facilitate the next engine start.

#### Deactivating the ATA

▶ Press the ,  or  button on the SmartKey.

or

▶ Press the start/stop button with the SmartKey in the stowage compartment (→ page 130)

**Deactivating the alarm using KEYLESS-GO**

- ▶ Grasp the outside door handle with the SmartKey outside the vehicle.

**Function of the tow-away alarm**

- ⓘ This function may not be available in all countries.

An audible and visual alarm is triggered if an alteration to your vehicle's angle of inclination is detected while the tow-away alarm is armed.

The tow-away alarm is automatically armed after approximately 60 seconds:

- after the vehicle is locked with the SmartKey
- after the vehicle is locked using KEYLESS-GO

The tow-away alarm is armed only when the following components are closed:

- doors
- trunk lid

The tow-away alarm is automatically deactivated:

- after the  or  button on the SmartKey is pressed

- after the start/stop button is pressed with the SmartKey in the stowage compartment (→ page 130)
- after the vehicle is unlocked using KEYLESS-GO
- when HANDS-FREE ACCESS is in use

Information on collision detection when a vehicle is parked (→ page 153).

**Activating/deactivating tow-away protection**

Multimedia system:

↳ Vehicle ▶  Vehicle Settings  
 ▶▶ Tow-away Protection

- ▶ Activate  or deactivate  the function.

Tow-away protection is reactivated in the following cases:

- The vehicle is unlocked again.
- A door is opened.
- The vehicle is locked again.

**Function of interior protection**

- ⓘ This function may not be available in all countries.

When interior protection is activated, a visual and audible alarm is triggered if movement is detected in the vehicle interior.



Interior protection is activated automatically after approximately ten seconds:

- after locking the vehicle with the key
- after locking the vehicle using KEYLESS-GO

Interior protection is activated only when the following components are closed:

- Doors
- Trunk lid

Interior protection is automatically deactivated:

- after pressing the  or  button on the key
- after pressing the start/stop button with the key in the stowage compartment (→ page 130)
- after unlocking the vehicle using KEYLESS-GO

- when using HANDS-FREE ACCESS

The following situations can lead to a false alarm:

- when there are moving objects such as mascots in the vehicle interior
- when a side window is open
- when a panoramic sliding sunroof is open

### Activating/deactivating interior protection

Multimedia system:

 Vehicle   Vehicle Settings

 Interior Motion Sensor

 Activate  or deactivate  the function.

Interior protection is reactivated in the following cases:

- The vehicle is unlocked again.
- A door is opened.
- The vehicle is locked again.

### Notes on the correct driver's seat position

**⚠ WARNING** Risk of accident due to adjusting the vehicle settings while the vehicle is in motion

You could lose control of the vehicle in the following situations in particular:

- If you adjust the driver's seat, the head restraint, the steering wheel or the mirror while the vehicle is in motion
- If you fasten your seat belt while the vehicle is in motion

► Before starting the vehicle: in particular, adjust the driver's seat, head restraint, steering wheel and mirror, and fasten your seat belt.

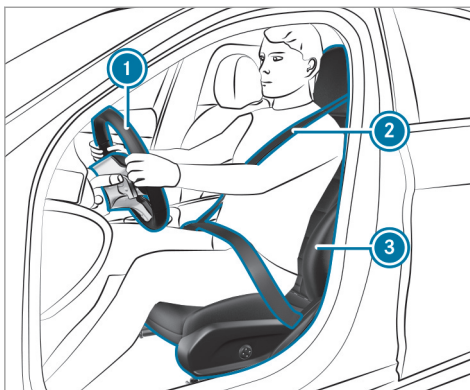

Ensure the following when adjusting the steering wheel ①, seat belt ② and driver's seat ③:

- You are sitting as far away from the driver's airbag as possible, taking the following points into consideration:
- You are sitting in an upright position
- Your thighs are slightly supported by the seat cushion

- Your legs are not fully extended and you can depress the pedals properly
- The back of your head is supported at eye level by the center of the head restraint
- You can hold the steering wheel with your arms slightly bent
- You can move your legs freely
- You can see all the displays on the instrument cluster clearly
- You have a good overview of the traffic conditions
- Your seat belt sits snugly against your body and passes across the center of your shoulder and across your hips in the pelvic area



## Seats

### Manual and electrical front seat adjustment (without Seat Comfort Package)

**⚠ WARNING** Risk of becoming trapped if the seats are adjusted by children

Children could become trapped if they adjust the seats, particularly when unattended.

- ▶ When leaving the vehicle, always take the SmartKey with you and lock the vehicle.
- ▶ Never leave children unattended in the vehicle.

You can adjust the seats when the vehicle is switched off.

**⚠ WARNING** Risk of becoming trapped when adjusting the seat

When you adjust a seat, you or other vehicle occupants could become trapped, e.g. on the seat guide rail.

- ▶ When adjusting a seat, make sure that no one has any part of their body within the sweep of the seat.

Observe the safety notes on "air bags" and "Children in the vehicle".

**⚠ WARNING** Risk of accident due to the driver's seat not being engaged

The driver's seat may move unexpectedly while driving.

This could cause you to lose control of the vehicle.

- ▶ Always make sure that the driver's seat is engaged before starting the vehicle.

**⚠ WARNING** Risk of accident due to adjusting the vehicle settings while the vehicle is in motion

You could lose control of the vehicle in the following situations in particular:

- If you adjust the driver's seat, the head restraint, the steering wheel or the mirror while the vehicle is in motion
- If you fasten your seat belt while the vehicle is in motion

- ▶ Before starting the vehicle: in particular, adjust the driver's seat, head restraint, steering wheel and mirror, and fasten your seat belt.

**⚠ WARNING** Risk of becoming trapped if the seat height is adjusted carelessly

If you adjust the seat height carelessly, you or other vehicle occupants could be trapped and thereby injured.

Children in particular could accidentally press the electrical seat adjustment buttons and become trapped.

- ▶ While moving the seats, make sure that hands or other body parts do not get under the lever assembly of the seat adjustment system.

**⚠ WARNING** Risk of injury due to head restraints not being installed or being adjusted incorrectly

If head restraints have not been installed or have not been adjusted correctly, there is an increased risk of injury in the head and neck area, e.g. in the event of an accident or when braking.

- ▶ Always drive with the head restraints installed.
- ▶ Before driving off, make sure for every vehicle occupant that the center of the head restraint supports the back of the head at about eye level.

Do not rotate the head restraints on the front and rear seats. Otherwise, you will not be able to adjust the height and angle of the head restraints correctly.

Adjust the head restraint fore-and-aft position so that it is as close as possible to the back of your head.

**⚠ WARNING** Risk of injury or death due to an incorrect seat position

The seat belt does not offer the intended level of protection if you have not moved the seat backrest to an almost vertical position.

In particular, you could slip beneath the seat-belt and become injured.

- ▶ Adjust the seat properly before beginning your journey.
- ▶ Always ensure that the seat backrest is in an almost vertical position and that the shoulder belt is routed across the center of your shoulder.

**⚠ WARNING** Risk of injury due to excessive strain on the grab handle

If you apply your full body weight to the grab handle or pull it abruptly, the grab handle may be damaged or become loose from its anchorage.

- ▶ Use the grab handles only to stabilize the seating position or to assist in getting in and out of the seat.

**⚠ WARNING** Risk of injury or death due to objects under the co-driver seat

Objects trapped under the co-driver seat can interfere with the function of the automatic co-driver airbag shutoff or damage the system.

- ▶ Do not store any objects under the co-driver seat.
- ▶ When the co-driver seat is occupied, make sure that no objects are trapped under the co-driver seat.

**!** **NOTE** Damage to the seats when moving the seats back

The seats may be damaged by objects when moving the seats back.

- ▶ When moving the seats back, make sure that there are no objects in the footwell, under or behind the seats.

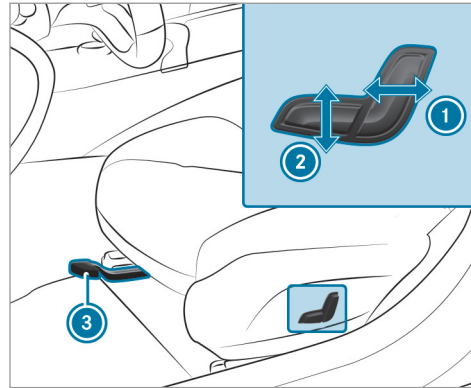

- ① Seat backrest inclination
- ② Seat height
- ③ Seat fore-and-aft position

▶ **To adjust the seat fore-and-aft position:** lift lever ③ and slide the seat into the desired position.

▶ Make sure that the seat is engaged.

### Electrical front seat adjustment

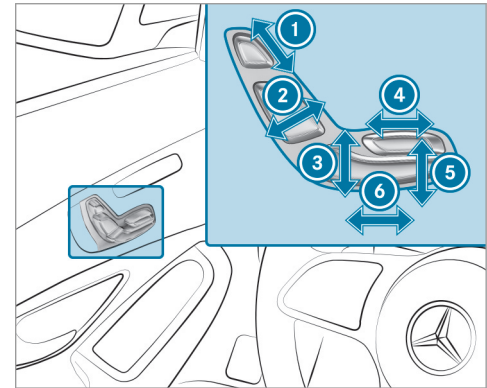

- ① Head restraint height
- ② Seat backrest inclination
- ③ Seat height
- ④ Seat cushion length
- ⑤ Seat cushion inclination
- ⑥ Seat fore-and-aft position

- ▶ Save the settings with the memory function (→ page 99).

### Adjusting the 4-way lumbar support

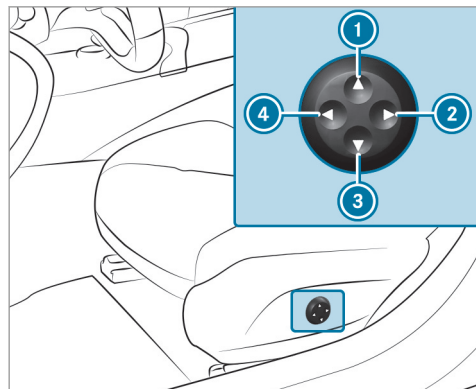

- ① Higher
- ② Softer
- ③ Lower
- ④ Firmer

- ▶ Use buttons ① to ④ to adjust the contour of the backrest.

### Head restraints

#### Manual adjustment of front seat head restraints

- ⚠ **WARNING** Risk of accident due to adjusting the vehicle settings while the vehicle is in motion

You could lose control of the vehicle in the following situations in particular:

- If you adjust the driver's seat, the head restraint, the steering wheel or the mirror while the vehicle is in motion
  - If you fasten your seat belt while the vehicle is in motion
- ▶ Before starting the vehicle: in particular, adjust the driver's seat, head restraint, steering wheel and mirror, and fasten your seat belt.

- ⚠ **WARNING** Risk of injury due to head restraints not being installed or being adjusted incorrectly

If head restraints have not been installed or have not been adjusted correctly, there is an increased risk of injury in the head and neck area, e.g. in the event of an accident or when braking.

- ▶ Always drive with the head restraints installed.
- ▶ Before driving off, make sure for every vehicle occupant that the center of the head restraint supports the back of the head at about eye level.

Do not rotate the head restraints on the front and rear seats. Otherwise, you will not be able to adjust the height and angle of the head restraints correctly.

Adjust the head restraint fore-and-aft position so that it is as close as possible to the back of your head.

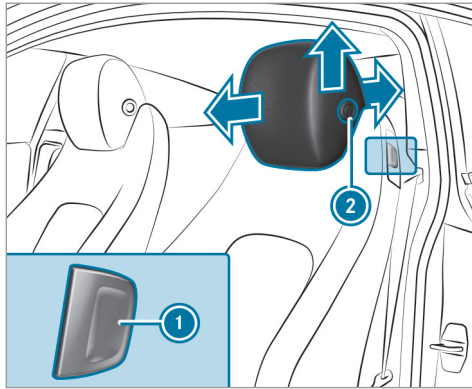

- ▶ **To raise:** pull the head restraint up.
- ▶ **To lower:** press release knob ① in the direction of the arrow and push the head restraint down.
- ▶ **To move forwards:** pull the head restraint forwards.
- ▶ **To move backwards:** press and hold release knob ②.

- ▶ Push the head restraint backwards and let go of release knob ②.

#### Mechanical adjustment of rear head restraints

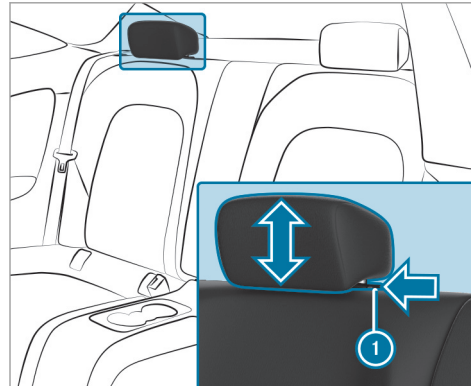

- ▶ **To raise:** pull the head restraint up.
- ▶ **To lower:** press release knob ① in the direction of the arrow and push the head restraint down.

#### Installing/removing the rear seat head restraints

##### Removing

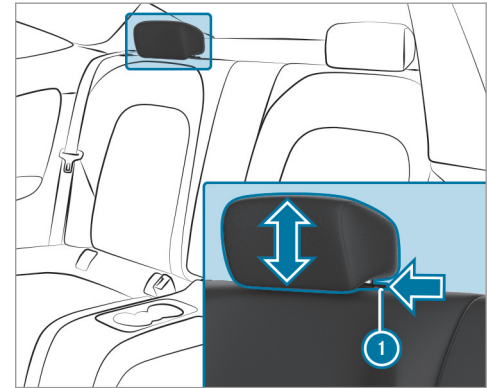

- ▶ Release the rear seat backrest and fold it forwards slightly (→ page 102).
- ▶ Pull the head restraint upwards as far as it will go.
- ▶ Push release knob ① in the direction of the arrow and pull out the head restraint.

### Installing

- ▶ Insert the head restraint such that the notches on the bar are on the left when viewed in the direction of travel.
- ▶ Push the head restraint down until it engages.
- ▶ Fold the rear seat backrest back until it engages.

### Configuring the seat settings

Multimedia system:

→  ▶ **Comfort** ▶ **Seat Comfort**

- ▶ Select a seat.

### Adjusting the backrest side bolsters

- ▶ Select **Side Bolsters**.
- ▶ Adjust the air cushions.

### Adjusting the backrest contour in the lumbar region of the seat backrest (lumbar)

- ▶ Select **Lumbar**.
- ▶ Adjust the air cushions.

### Selecting the massage program for the front seats

Multimedia system:

→ **Vehicle** ▶  **Seats**

- ▶ Select **Driver's Seat** or **Passenger**.
- ▶ Select **Massage**.
- ▶ Select a massage program.  
The massage program runs for approximately 9 to 15 minutes, depending on the setting.
- ▶ **To set the massage intensity:** switch **High Intensity** on  or off .

### Resetting seat settings

Multimedia system:

→ **Vehicle** ▶  **Seats** ▶ **Reset**

- ▶ Select **Yes** or **No**.

Depending on whether the settings for the driver's or front passenger seat are selected, only the selected seat can be reset.

### Folding the front seat backrest forwards/back (vehicles with memory function)

If you fold the seat backrest forwards, the seat will move forwards with the EASY-ENTRY function. This allows passengers to get into and out of the rear passenger compartment comfortably.

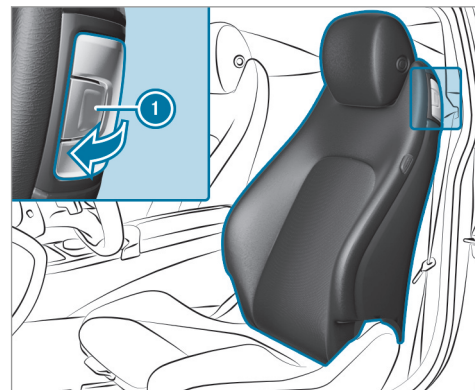

- ▶ **To fold forward:** pull seat release handle ❶ and fold the seat backrest forwards as far as it will go. The seat will automatically move to the foremost position.
- ▶ **To fold back:** swing the seat backrest back horizontally. If the seat backrest is not engaged, this will be shown on the multifunction display on the instrument cluster. A warning tone will also sound. The seat will automatically move to the stored position.

### Folding the front seat backrest forwards/backwards (vehicles without memory function)

#### Folding forwards

If you fold the seat backrest forwards, the seat will move forwards with the EASY-ENTRY function. This allows passengers to get into and out of the rear passenger compartment comfortably.

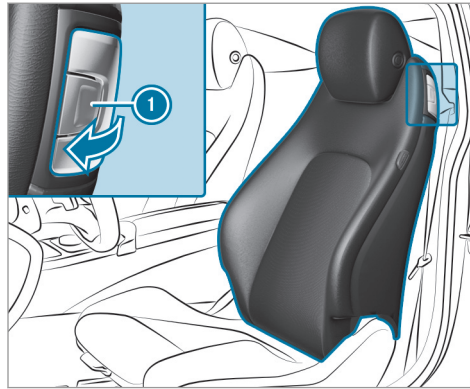

- ▶ If necessary, release the head restraint and push it down.
- ▶ Pull seat release handle ❶ and fold the seat backrest forwards until the seat backrest engages.
- ▶ Push the seat as far forwards as it will go.

#### Folding back

- ▶ Push the seat back horizontally by the seat backrest until it reaches the seat position that was previously set.
- ▶ Fold the seat backrest back until it engages. Do so as smoothly as possible. If the seat backrest is not engaged, this will be shown on the multifunction display on the instrument cluster. A warning tone will also sound.
- ▶ After the seat backrest has been folded back, check the position of the head restraint and set it to the correct position.

If the set seat position can no longer be reached, e.g. because of luggage in the rear footwell or because occupants have entered the rear passenger compartment of the vehicle:

- ▶ Pull seat release handle ❶ again and return the seat backrest to an upright position. The seat will lock in the new fore-and-aft position.

### Switching the seat heating on/off

**⚠ WARNING** Risk of burns due to repeatedly switching on the seat heating

Repeatedly switching on the seat heating can cause the seat cushion and seat backrest padding to become very hot.

In particular, the health of persons with limited temperature sensitivity or a limited ability to react to high temperatures may be affected or they may even suffer burn-like injuries.

- ▶ Do not repeatedly switch on the seat heating.

To protect against overheating, the seat heating may be temporarily deactivated after it has been switched on repeatedly.

**! NOTE** Damage to the seats caused by objects or documents when the seat heating is switched on

When the seat heating is switched on, overheating may occur due to objects or docu-

ments placed on the seats, e.g. seat cushions or child seats. This could cause damage to the seat surface.

- ▶ Make sure that no objects or documents are on the seats when the seat heating is switched on.

#### Requirements:

- The power supply is switched on.

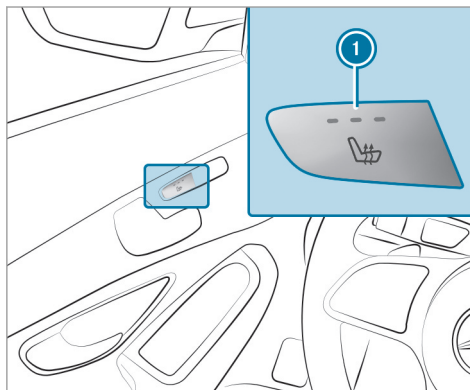

- ▶ Press button ① repeatedly until the desired heating level is set. Depending on the heating level, up to three indicator lamps will light up. If all indicator lamps are off, the seat heating is switched off.

- ⓘ The seat heating will automatically switch down from the three heating levels after 8, 10 and 20 minutes until the seat heating is switched off.

### Switching the seat ventilation on/off

#### Requirements:

- The power supply is switched on.



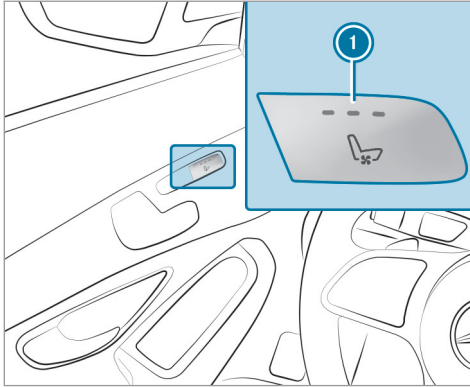

- ▶ Press button ① repeatedly until the desired blower setting has been reached. Depending on the blower setting, up to three indicator lamps will light up. If all indicator lamps are off, the seat ventilation is switched off.

### Steering wheel

#### Adjusting the steering wheel mechanically

- ⚠ **WARNING** Risk of accident due to adjusting the vehicle settings while the vehicle is in motion

You could lose control of the vehicle in the following situations in particular:

- If you adjust the driver's seat, the head restraint, the steering wheel or the mirror while the vehicle is in motion
  - If you fasten your seat belt while the vehicle is in motion
- ▶ Before starting the vehicle: in particular, adjust the driver's seat, head restraint, steering wheel and mirror, and fasten your seat belt.

- ⚠ **WARNING** Risk of entrapment for children when adjusting the steering wheel

Children could injure themselves if they adjust the steering wheel.

- ▶ Never leave children unattended in the vehicle.
- ▶ When leaving the vehicle, always take the SmartKey with you and lock the vehicle.

### Unlocking

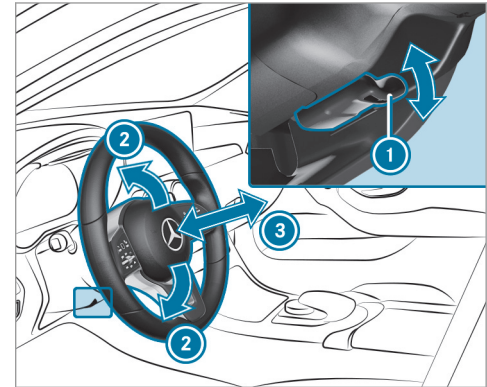

- ▶ Fold release lever ① down as far as it will go.

- ▶ Adjust height ② and distance ③ to the steering wheel.

### Locking

- ▶ Fold release lever ① up as far as it will go.
- ▶ Check and make sure that the steering column is locked by moving the steering wheel.

### Adjusts the steering wheel electrically

The steering wheel can be adjusted when the power supply is disconnected.

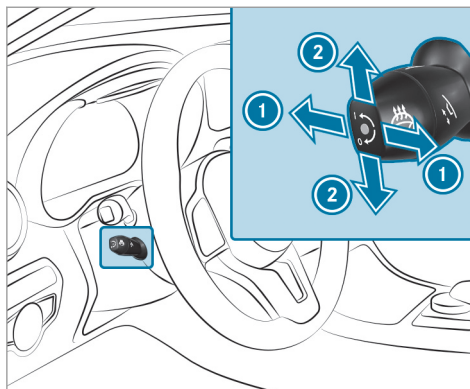

- ① To adjust the distance to the steering wheel
- ② Adjusting the height
- ▶ Save the settings with the memory function (→ page 99).

### Switching the steering wheel heater on/off

#### Requirements:

- The vehicle is switched on.

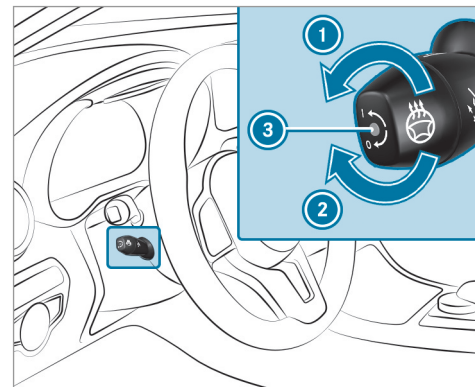

- ▶ Turn the lever in the direction of arrow ① or ②.  
If indicator lamp ③ lights up, the steering wheel heater is switched on.

When you switch the vehicle off, the steering wheel heater will switch off.

### Easy entry and exit feature

#### Using the easy entry and exit feature

**⚠ WARNING** Risk of accident when pulling away during the adjustment process of the easy entry and exit feature

You could lose control of the vehicle.

- ▶ Always wait until the adjustment process is complete before driving off.

**⚠ WARNING** Risk of becoming trapped during adjustment of the easy entry and exit feature

You and other vehicle occupants – particularly children – could become trapped.

- ▶ Ensure that no one has a body part in the sweep of the steering wheel or driver's seat.

If there is a risk of becoming trapped by the steering wheel:

- ▶ Move the adjustment lever of the steering wheel.  
The adjustment process will be stopped.

If there is a risk of becoming trapped by the driver's seat:

- ▶ Press the seat adjustment switch.  
The adjustment process will be stopped.
- ▶ Never leave children unattended in the vehicle.
- ▶ When leaving the vehicle, always take the SmartKey with you and lock the vehicle.

**Vehicles with memory function:** you can stop the adjustment process by pressing one of the memory function position switches.

**⚠ WARNING** Risk of becoming trapped if children activate the easy entry and exit feature-

Children could become trapped if they activate the easy entry- and exit feature, particularly when unattended.

- ▶ Never leave children unattended in the vehicle.
- ▶ When leaving the vehicle, always take the SmartKey with you and lock the vehicle.

If the easy entry and exit feature is active, the steering wheel will move upwards and the driver's seat will move back in the following situations:

- You switch off the vehicle when the driver's door is open.
  - You open the driver's door when the vehicle is switched off.
- i** The steering wheel will then move upwards only if it is not already as high as it will go. The driver's seat can be moved back only if it is not already in the rearmost seat adjustment range.

The steering wheel and the driver's seat will move back to the last driving position in the following cases:

- You switch the power supply or the vehicle on when the driver's door is closed
- You close the driver's door when the vehicle is switched on.

The last driving position will be saved when:

- You switch off the vehicle.
- **Vehicles with memory function:** you save the seat settings via the memory function.

**Vehicles with memory function:** press one of the memory function position switches to stop the adjustment process.

### Adjusting the easy entry and exit feature

Multimedia system:

→ Vehicle ►  Vehicle Settings  
►► Easy Entry/Exit

- Select **Steering Wheel & Seat, Steering Wheel Only** or **Off**.

### Memory function

#### Function of the memory function

**⚠ WARNING** Risk of an accident if the memory function is used while driving

If you use the memory function on the driver's side while driving, you could lose control of the vehicle as a result of the adjustments being made.

- Only use the memory function on the driver's side when the vehicle is stationary.

**⚠ WARNING** Risk of entrapment when adjusting the seat with the memory function

When the memory function adjusts the seat or steering wheel, you and other vehicle occupants – particularly children – could become trapped.

- During the adjusting process of the memory function, ensure that no body

parts are in the sweep of the seat or the steering wheel.

- If somebody becomes trapped, immediately release the memory function position button.  
The adjustment process is stopped.

**⚠ WARNING** Risk of entrapment if the memory function is activated by children

Children could become trapped if they activate the memory function, particularly when unattended.

- Never leave children unattended in the vehicle.
- When leaving the vehicle, always take the SmartKey with you and lock the vehicle.

You can use the memory function when the vehicle is switched off.

Seat adjustments for up to three people can be stored and called up using the memory function.

You can save settings for the following systems:

- Seat, backrest and head restraint

- Steering wheel
- Outside mirrors
- Head-up display

### Operating the memory function

#### Storing

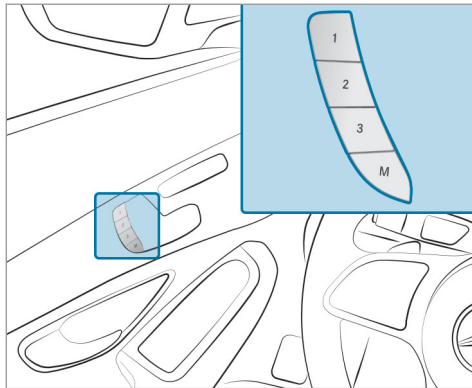

- ▶ Set the desired position for all systems.

- ▶ Briefly press memory button **M** and then press preset position **1**, **2** or **3** within three seconds. An acoustic signal sounds. The settings are stored.
- ▶ **To call up:** press and hold preset position button **1**, **2** or **3** until all the systems are in the stored position.

- ⓘ When you release the preset position button, steering wheel, the seat and mirror setting functions stop immediately. The head-up display continues to be adjusted.

#### Stowage areas

#### Notes on loading the vehicle

- ⚠ **DANGER** Risk of exhaust gas poisoning

Combustion engines emit poisonous exhaust gases such as carbon monoxide. Exhaust gases can enter the vehicle interior if the trunk lid is open when the engine is running, especially if the vehicle is in motion.

- ▶ Always switch off the engine before opening the trunk lid.
- ▶ Never drive with the trunk lid open.

- ⚠ **WARNING** Risk of injury from unsecured items in the vehicle

If objects, luggage or loads are not secured or not secured sufficiently, they could slip, tip over or be thrown around and thereby hit vehicle occupants.

There is a risk of injury, particularly in the event of sudden braking or a sudden change in direction.

- ▶ Always stow objects in such a way that they cannot be thrown around.
- ▶ Before the journey, secure objects, luggage or loads against slipping or tipping over.

**▲ WARNING** Risk of injury due to objects being stowed incorrectly

If objects in the vehicle interior are stowed incorrectly, they can slide or be thrown around and hit vehicle occupants. In addition, cup holders, open storage spaces and mobile phone brackets cannot always retain all objects they contain.

There is a risk of injury, particularly in the event of sudden braking or a sudden change in direction.

- ▶ Always stow objects in such a way that they cannot be thrown around in such situations.
- ▶ Always make sure that objects do not protrude from storage spaces, parcel nets or storage nets.
- ▶ Close the lockable storage spaces before starting a journey.
- ▶ Always stow and secure heavy, hard, pointed, sharp-edged, fragile or bulky objects in the trunk.

**Vehicles with automatic front passenger air bag shutoff:** objects trapped under the front passenger seat may interfere with the function of the automatic front passenger air bag shutoff or damage the system. Please observe the notes on the function of the automatic front passenger air bag shutoff (→ page 46).

**▲ WARNING** - Risk of accident or injury when using the cup holder while the vehicle is moving

The cup holder cannot secure containers while the vehicle is moving.

If you use a cup holder while the vehicle is moving, the container may be flung around and liquids may be spilled. The vehicle occupants may come into contact with the liquid and if it is hot, they could be scalded. You could be distracted from traffic conditions and you may lose control of the vehicle.

- ▶ Only use the cup holder when the vehicle is stationary.
- ▶ Only use the cup holder for containers of the right size.

- ▶ Close the container, particularly if the liquid is hot.

**! NOTE** Damage to the handle in the trunk floor

If the handle in the trunk is left protruding, the handle may be damaged.

- ▶ Before closing the trunk lid, detach the handle and press it down closed again.

**! NOTE** Damage to the stowage compartment under the ashtray due to intense heat

The stowage compartment under the ashtray is not heat resistant and could be damaged if you rest a lit cigarette on it.

- ▶ Make sure that the ashtray is fully engaged.

**⚠ WARNING** - Risk of fire and injury from hot cigarette lighter

You can burn yourself if you touch the hot heating element or the socket of the cigarette lighter.

In addition, flammable materials may ignite if:

- you drop the hot cigarette lighter
  - a child holds the hot cigarette lighter to objects, for example
- ▶ Always hold the cigarette lighter by the knob.
  - ▶ Always make sure that the cigarette lighter is out of reach of children.
  - ▶ Never leave children unattended in the vehicle.

**⚠ WARNING** Risk of burns from the tailpipe and tailpipe trims

The exhaust tailpipe and tailpipe trims can become very hot. If you come into contact with these parts of the vehicle, you could burn yourself.

- ▶ Always be particularly careful around the tailpipe and the tailpipe trims and supervise children especially closely in this area.
- ▶ Allow vehicle parts to cool down before touching them.

The driving characteristics of your vehicle are dependent on the distribution of the load within the vehicle. You should bear the following in mind when loading the vehicle:

- Never exceed the permissible gross mass or the gross axle weight rating for the vehicle (including occupants). The values are specified on the vehicle identification plate on the vehicle's B-pillar.
- the load must not protrude above the upper edge of the seat backrests.
- always place the load behind unoccupied seats if possible.
- secure the load using the tie-down eyes and distribute the load evenly.

Notes on driving with a roof load

- Evenly distribute the roof load, and place heavy objects at the bottom. Also comply with the notes on loading the vehicle (→ page 99).
- Drive attentively, and avoid suddenly pulling away, braking and steering as well as rapid cornering.
- When transporting roof loads and when the vehicle is fully loaded or fully occupied, select drive programs **[E]** and **[C]**. These are designed to focus on stability (→ page 138).

## Stowage spaces in the vehicle interior

### Overview of the front stowage compartments

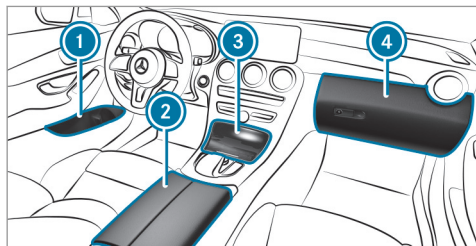

- 1 Stowage spaces in the doors
- 2 Stowage compartment in the armrest with a multimedia and USB connection
- 3 Stowage compartment in the front center console with USB port
- 4 Glove box

## Through-loading feature in the rear bench seat (EASY-PACK Quickfold)

### Folding the rear seat backrest forwards

**⚠ WARNING** Risk of accident if the rear bench seat, rear seat and seat backrest are not engaged

The rear bench seat, rear seat and seat backrest may fold forwards, even when you are driving.

- As a result, the vehicle occupant will be pushed into the seat belt with increased force. The seat belt will not be able to protect as intended and could cause additional injury.
- Objects or loads in the trunk or cargo compartment will not be restrained by the seat backrest.

▶ Make sure that the rear bench seat, the rear seat and the seat backrest are engaged before every trip.

If the left and right seat backrests are not engaged and locked in place, this will be shown on the multifunction display on the instrument cluster. A warning tone will also sound.

If the center seat backrest is not engaged and locked in place, the lock verification indicator will be red.

#### Requirements:

- To fold the center seat backrest forwards: the center seat backrest has been unlocked.

You can fold the center and outer seat backrests forwards separately.



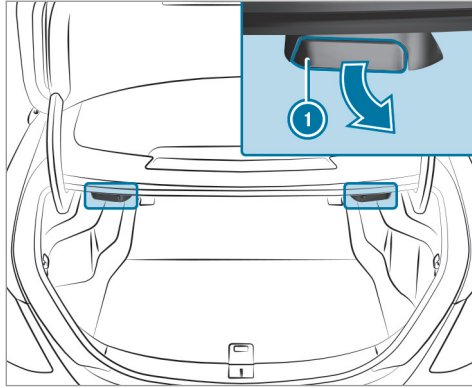

- ▶ **Vehicles without a memory function:** Move the driver's or front passenger seat forwards, if necessary.

**Vehicles with a memory function:** If necessary, when the seat backrest in the rear passenger compartment is folded forward, the corresponding front seat will move forwards slightly to avoid a collision.

- ▶ If necessary, fully insert the head restraints into the rear seat backrest.
- ▶ **To fold the left and right seat backrests forward:** pull right or left release handle ①.

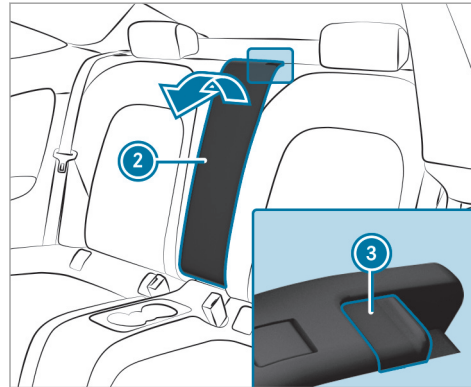

- ▶ **To fold the center seat backrest forwards:** pull release catch ③ of seat backrest ② forwards.
- ▶ Fold seat backrest ② forwards.

- ▶ If necessary, reset the driver's or front passenger seat.

### Folding back the rear seat backrest

**⚠ WARNING** Risk of becoming trapped when adjusting the seats

When you adjust a seat, you may trap yourself or a vehicle occupant.

- ▶ When adjusting a seat, make sure that no one has any body parts in the sweep of the seat.

**! NOTE** Damage caused by trapping the seat belt when folding back the seat backrest

The seat belt could become trapped and thus damaged when the seat backrest is folded back.

- ▶ Make sure that the seat belt is not trapped when folding back the seat backrest.

- ▶ Move the driver's or front passenger seat forwards, if necessary.

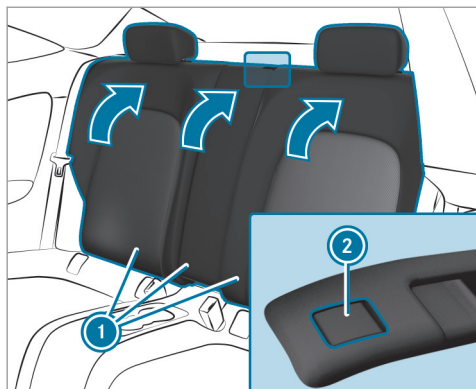

- ▶ Fold the corresponding seat backrest ① back until it engages.

**Left and right seat backrests:** if the seat backrest is not engaged and locked in place, this will be shown on the multifunction display on the instrument cluster.

A warning tone will also sound.

**Center seat backrest:** if the seat backrest is not engaged and locked in place, the red lock verification indicator ② will be visible.

#### Locking the release catch of the center rear seat backrest

##### Requirements:

- The left and center seat backrests are engaged and joined together.

You can lock the center seat backrest release catch if you want to secure the trunk against unauthorized access. The center seat backrest can then be folded forwards only together with the left seat backrest.

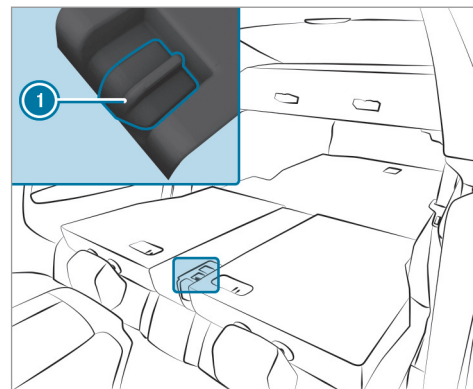

- ▶ Fold the center and left seat backrests forwards.
- ▶ **To lock or unlock:** slide catch ① upwards or downwards.

#### Overview of the tie-down eyes

Observe the notes on loading the vehicle (→ page 99).

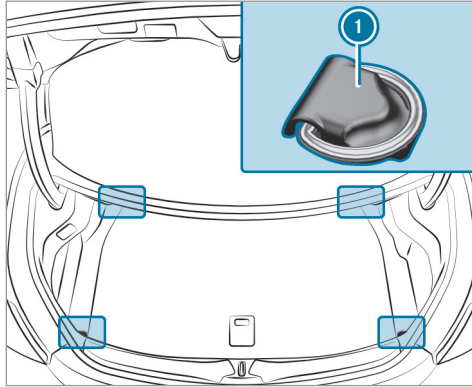

- ① Tie-down eyes (vehicles with through-loading feature in the rear bench seat)

### Using the bag hooks

**⚠ WARNING** Risk of injury when using bag hooks with heavy objects

The bag hooks cannot restrain heavy objects or items of luggage.

Objects or items of luggage may be flung around and hit vehicle occupants.

- ▶ Only hang light objects on the bag hooks.
- ▶ Never hang hard, sharp-edged or fragile objects on the bag hooks.

Subject the bag hooks to a maximum load of 6.6 lbs (3 kg) and do not attach any goods to them.

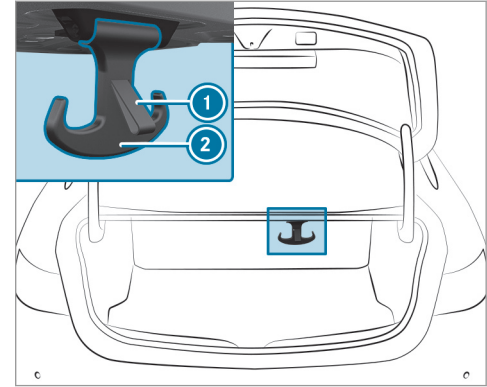

- ▶ Pull bag hook ② down by tab ①.

- ⓘ Observe the notes on loading the vehicle (→ page 99).

### Attaching the parcel net

**⚠ WARNING** Risk of injury due to objects being stowed incorrectly

If objects in the vehicle interior are stowed incorrectly, they can slide or be thrown around and hit vehicle occupants. In addition, cup holders, open storage spaces and mobile phone brackets cannot always retain all objects they contain.

There is a risk of injury, particularly in the event of sudden braking or a sudden change in direction.

- ▶ Always stow objects in such a way that they cannot be thrown around in such situations.
- ▶ Always make sure that objects do not protrude from storage spaces, parcel nets or storage nets.
- ▶ Close the lockable storage spaces before starting a journey.

- ▶ Always stow and secure heavy, hard, pointed, sharp-edged, fragile or bulky objects in the trunk.

Observe the notes on loading the vehicle.

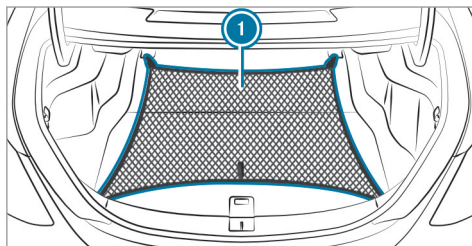

- ▶ Vehicles with through-loading feature in the rear bench seat: fold up the tie-down eyes.
- ▶ Hook parcel net ① into the front and rear tie-down eyes.
- ▶ Vehicles without a through-loading feature in the rear bench seat: hook the rings into the parcel net hooks ①.

- ▶ Place the rings into the hooks on the trunk floor.

### Attaching a roof luggage rack

**⚠ WARNING** Risk of accident due to exceeding the maximum roof load

The vehicle center of gravity and the usual driving characteristics as well as the steering and braking characteristics alter.

If you exceed the maximum roof load, the driving characteristics, as well as steering and braking, will be greatly impaired.

- ▶ Never exceed the maximum roof load and adjust your driving style.

You will find information on the maximum roof load in the "Technical data" section.

**!** **NOTE** Damage to the vehicle due to not observing the maximum permitted headroom clearance

If the vehicle height is greater than the maximum permitted headroom clearance, the roof and other parts of the vehicle may be damaged.

- ▶ Observe the signposted headroom clearance.
- ▶ If the vehicle height is greater than the permitted headroom clearance, do not enter.
- ▶ Observe the changed vehicle height with add-on roof equipment.

**!** **NOTE** Vehicle damage from non-approved roof luggage racks

The vehicle could be damaged by roof luggage racks that have not been tested and approved for Mercedes-Benz.

- ▶ Use only roof luggage racks tested and approved for Mercedes-Benz.

- ▶ Depending on the vehicle equipment, ensure that the sliding sunroof can be fully raised when the roof luggage rack is installed.
- ▶ Depending on the vehicle equipment, ensure that the trunk lid can be fully opened when the roof luggage rack is installed.
- ▶ Position the load on the roof luggage rack in such a way that the vehicle will not sustain damage even when it is in motion.

**!** **NOTE** Damage to the panorama roof with power tilt/sliding panel due to non-approved roof luggage racks

The panorama roof with power tilt/sliding panel may be damaged by the roof luggage rack if you attempt to open it when using a roof luggage rack not tested and approved for Mercedes-Benz.

- ▶ When a roof luggage rack is installed, open the panorama roof with power tilt/

sliding panel only if this has been tested and approved for Mercedes-Benz.

The panorama roof with power tilt/sliding panel may be raised to allow ventilation of the vehicle interior.

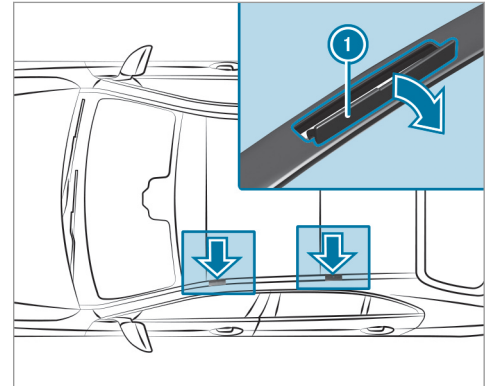

**NOTE** Damage to the covers

The covers may be damaged and scratched when being opened.

- ▶ Do not use metallic or hard objects.

- ▶ Carefully fold covers ① upwards in the direction of the arrow.
- ▶ Secure the roof luggage rack to the fastening points beneath covers ①.
- ▶ Comply with the installation instructions of the roof luggage rack manufacturer.
- ▶ Secure the load on the roof luggage rack.

### Sockets

#### Using the 12 V socket

##### Requirements

- Only devices up to a maximum of 180 W (15 A) are permissible.

Depending on the vehicle equipment, the vehicle has the following 12 V sockets:

- In the stowage compartment in the front center console
- In the front passenger footwell
- In the stowage compartment in the center console of the rear passenger compartment

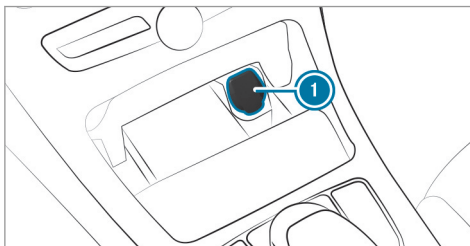

Example: 12 V socket in the stowage compartment in the front center console

- ▶ Fold up socket cap ①.
- ▶ Insert the plug of the device.

If you have connected a device to the 12 V socket, leave the cover of the stowage compartment open.

### Wireless charging of the mobile phone and connection with the exterior antenna

#### Notes on wirelessly charging a mobile phone

**WARNING** Risk of injury due to objects being stowed incorrectly

If objects in the vehicle interior are stowed incorrectly, they can slide or be thrown around and hit vehicle occupants. In addition, cup holders, open stowage spaces and mobile phone receptacles cannot always retain all objects within.

There is a risk of injury, particularly in the event of sudden braking or a sudden change in direction.

- ▶ Always stow objects so that they cannot be thrown around in such situations.

- ▶ Always make sure that objects do not protrude from stowage spaces, parcel nets or stowage nets.
- ▶ Close the lockable stowage spaces before starting a journey.
- ▶ Always stow and secure heavy, hard, pointed, sharp-edged, fragile or bulky objects in the trunk/cargo compartment.

Observe the notes on loading the vehicle.

**⚠ WARNING** Risk of fire from placing objects in the mobile phone storage compartment

Placing other objects in the mobile phone storage compartment could constitute a fire hazard.

- ▶ Apart from a mobile phone, do not place any other objects in the mobile phone storage compartment, especially those made of metal.

**! NOTE** Damage to objects caused by placing them in the mobile phone storage compartment

If objects are placed in the mobile phone storage compartment, these may be damaged by electromagnetic fields.

- ▶ Do not place credit cards, storage media, ski passes or other objects sensitive to electromagnetic fields in the mobile phone storage compartment.

**! NOTE** Damage to the mobile phone stowage compartment caused by liquids

If liquids enter the mobile phone stowage compartment, the compartment may be damaged.

- ▶ Ensure that no liquids enter the mobile phone stowage compartment.

The following notes on wirelessly charging a mobile phone must be observed:

- Depending on the vehicle equipment, the mobile phone is connected to the vehicle's exterior antenna via the charging module.
- The charging function and wireless connection of the mobile phone to the vehicle's exterior antenna are only available if the ignition is switched on.
- It may not be possible to charge small mobile phones in every part of the mobile phone stowage compartment.
- It may not be possible to charge large mobile phones that do not rest flat in the mobile phone stowage compartment or connect them to the vehicle's exterior antenna.
- The mobile phone may heat up during the charging process. In particular, this may depend on the applications (apps) currently open in the background.
- To ensure more efficient charging and connection with the vehicle's exterior antenna, remove the protective cover from the mobile

phone. Protective covers that are necessary for wireless charging are an exception.

### Charging a mobile phone wirelessly

#### Requirements

- The mobile phone is suitable for wireless charging.

A list of compatible mobile phones can be found at: <https://www.mercedes-benz-mobile.com>.

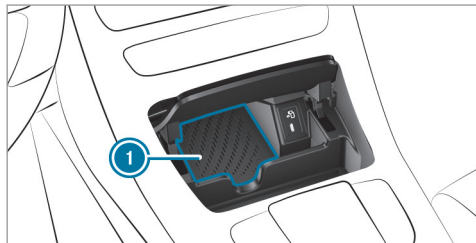

- ▶ Place the mobile phone as close to the center of mat ① as possible with the display facing upwards.

When the charging symbol is shown in the multimedia system, the mobile phone is being charged.

Malfunctions during the charging process are shown on the central display.

- ① The mat can be removed by the tab for cleaning, e.g. using clean, lukewarm water.

### Installing/removing the floor mats

**⚠ WARNING** Risk of accident due to objects in the driver's footwell

Objects in the driver's footwell may impede pedal travel or block a depressed pedal.

This jeopardizes the operating and road safety of the vehicle.

- ▶ Stow all objects in the vehicle securely so that they cannot get into the driver's footwell.

- ▶ Always install the floor mats securely and as prescribed in order to ensure that there is always sufficient room for the pedals.
- ▶ Do not use loose floor mats and do not place floor mats on top of one another.

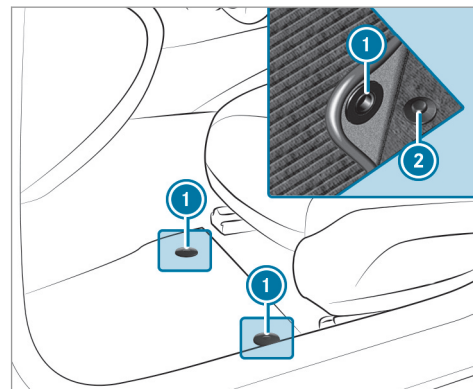

- ▶ **To install:** slide the corresponding seat backwards and lay the floor mat in the footwell.



- ▶ Press studs ① onto holders ②.
- ▶ Adjust the corresponding seat.
- ▶ **To remove:** pull the floor mat off the holders ②.
- ▶ Remove the floor mat.

## Exterior lighting

### Information about lighting systems and your responsibility

The various lighting systems of the vehicle are only aids. The driver of the vehicle is responsible for correct vehicle illumination in accordance with the prevailing light and visibility conditions, legal requirements and traffic situation.

## Light switch

### Operating the light switch

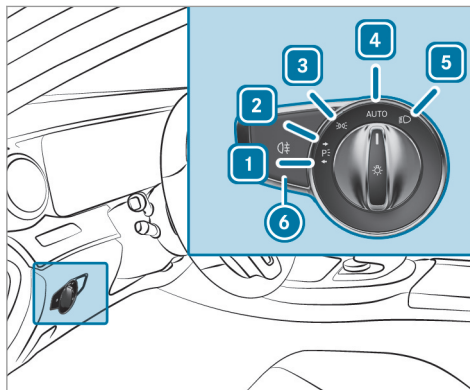

- 1 Left-hand parking lights
- 2 Right-hand parking lights
- 3 Standing lights and license plate lighting
- 4 **AUTO** Automatic driving lights (preferred light switch position)

- 5 Low beam/high beam
- 6 Switches the rear fog light on/off

When low beam is activated, the indicator lamp for the standing lights will be deactivated and replaced by the low-beam indicator lamp.

▶ Always park your vehicle safely using sufficient lighting, in accordance with the relevant legal stipulations.

**!** **NOTE** Battery discharging by operating the standing lights

Operating the standing lights over a period of hours puts a strain on the battery.

▶ Where possible, switch on the right or left parking light.

If the battery is insufficiently charged, the standing lights or parking lights will be switched off automatically to facilitate the next engine start.

The exterior lighting (except standing and parking lights) will switch off automatically when the driver's door is opened.

- Observe the notes on surround lighting (→ page 117).

### Automatic driving lights function

The standing lights, low beam and daytime running lights are switched on automatically depending on the ignition status and the ambient light.

**⚠ WARNING** Risk of accident when the low beam is switched off in poor visibility

When the light switch is set to **AUTO**, the low beam may not be switched on automatically if there is fog, snow or other causes of poor visibility such as spray.

- ▶ In such cases, turn the light switch to .

The automatic driving lights are only an aid. You are responsible for vehicle lighting.

### Switching the rear fog light on/off

#### Requirements

- The light switch is in the  or **AUTO** position.

- ▶ Press  button.

Please observe the country-specific laws on the use of rear fog lights.

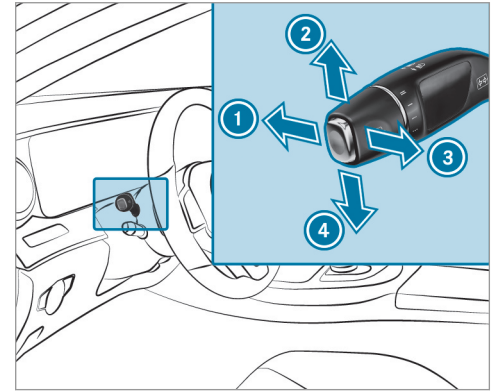

### Operating the combination switch for the lights



- ① High beam
- ② Turn signal light, right
- ③ Headlamp flashing
- ④ Turn signal light, left

- ▶ Use the combination switch to select the desired function.

**Switching on high beam**

- ▶ Turn the light switch to the  or **AUTO** position.
- ▶ Push the combination switch beyond the point of resistance in the direction of arrow ①. When the high beam is activated, the indicator lamp for low beam  will be deactivated and replaced by the indicator lamp for high beam .

**Switching off high beam**

- ▶ Move the combination switch back to its starting position.

**Headlamp flashing**

- ▶ Pull the combination switch in the direction of arrow ③.

**Turn signal light**

- ▶ **To indicate briefly:** push the combination switch briefly to the point of resistance in the direction of arrow ② or ④. The corresponding turn signal light will flash three times.

**To indicate permanently:** push the combination switch beyond the point of resistance in the direction of arrow ② or ④.

Vehicles with Active Lane Change Assist:

- A turn signal indicator activated by the driver may continue to operate for the duration of the lane change.
- If the driver indicated directly beforehand but a lane change was not immediately possible, the turn signal indicator may activate automatically.

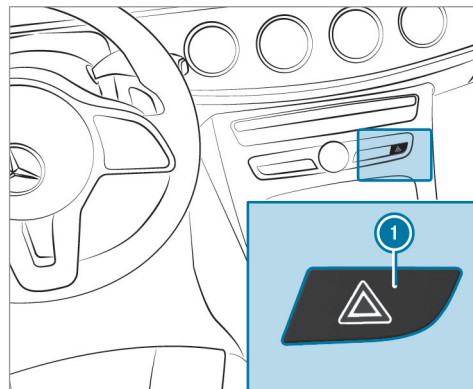
**Activating/deactivating the hazard warning lights**

- ▶ Press button ①.

The hazard warning lights will switch on automatically if:

- the air bag has been deployed.

## Cornering light

### Cornering light function

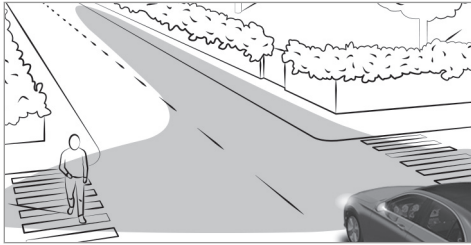

The cornering light improves the illumination of the road over a wide angle in the turning direction, enabling better visibility on tight bends, for example. The cornering light can be activated only when the low beam is switched on.

The function is active in the following cases:

- At speeds below 25 mph (40 km/h) when the turn signal light is switched on or the steering wheel is turned

- At speeds between 25 mph (40 km/h) and 43 mph (70 km/h) and when the steering wheel is turned

**Traffic circle and intersection function:** the cornering light will be activated on both sides based on an evaluation of the vehicle's current GPS position. It will remain active until after the vehicle has left the traffic circle or the intersection.

## Active headlamps

### Active headlamps function

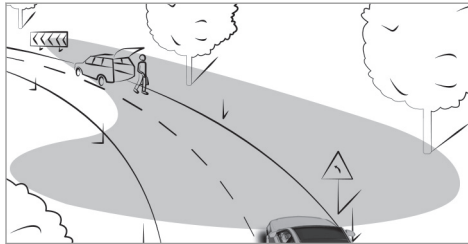

- The headlamps follow the steering movements.

- Relevant areas are better illuminated during a journey.

The functions are active when the low beam is switched on.

Depending on the vehicle's equipment, the course of the lane in which you are driving will also be evaluated and the active headlamps function will adjust the light in advance.

## Adaptive Highbeam Assist

### Adaptive Highbeam Assist function

**⚠ WARNING** Risk of accident despite Adaptive Highbeam Assist

Adaptive Highbeam Assist does not react to:

- Road users without lights, e.g. pedestrians
- Road users with poor lighting, e.g. cyclists
- Road users whose lighting is obstructed, e.g. by a barrier

On very rare occasions, Adaptive Highbeam Assist may fail to recognize other road users

with their own lighting, or may recognize them too late.

In these, or in similar situations, the automatic high beam will not be deactivated or will be activated despite the presence of other road users.

- ▶ Always observe the road and traffic conditions carefully and switch off the high beam in good time.

Adaptive Highbeam Assist cannot take into account road, weather or traffic conditions.

Detection may be restricted in the following cases:

- In poor visibility, e.g. fog, heavy rain or snow
- If there is dirt on the sensors or the sensors are obscured

Adaptive Highbeam Assist is only an aid. You are responsible for adjusting the vehicle's lighting to the prevailing light, visibility and traffic conditions.

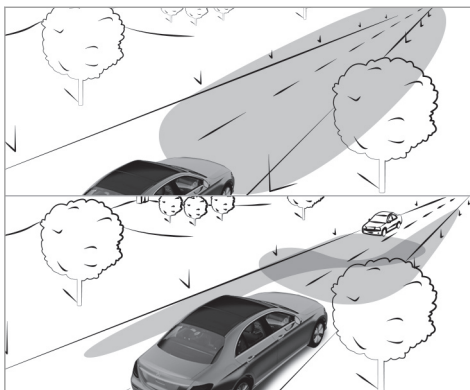

Adaptive Highbeam Assist automatically switches between the following types of light:

- Low beam
- High beam

At speeds greater than 19 mph (30 km/h):

- If no other road users are detected, the high beam will switch on automatically.

The high beam will switch off automatically in the following cases:

- At speeds below 16 mph (25 km/h)
- If other road users are detected
- If street lighting is sufficient

- ⓘ The system's optical sensor is located behind the windshield near the overhead control panel.

### Switching Adaptive Highbeam Assist on/off

#### Switching on

- ▶ Turn the light switch to the **AUTO** position.
- ▶ Switch on the high beam using the combination switch.  
If Adaptive Highbeam Assist is activated, the  indicator lamp will light up on the central display section of the instrument display.

#### Switching off

- ▶ Switch off the high beam using the combination switch.

### Switching the daytime running lights on/off

Multimedia system:

- ↳ Vehicle ▶ Light Settings
- ▶▶ Daytime Run. Lights

- ▶ Activate  or deactivate  the function.

### Setting the exterior lighting switch-off delay time

Multimedia system:

- ↳ Vehicle ▶ Light Settings
- ▶▶ Ext. Light Switch Off

- ▶ Set the switch-off delay time.

### Setting the surround lighting

Multimedia system:

- ↳ Vehicle ▶ Light Settings
- ▶▶ Locator Lighting

- ▶ Activate  or deactivate  the function.

If the surround lighting is switched on, the exterior lighting remains lit for 40 seconds after the vehicle is unlocked. When you start the vehicle, the

surround lighting is deactivated and the automatic driving lights are activated.

### Interior lighting

#### Adjusting the interior lighting

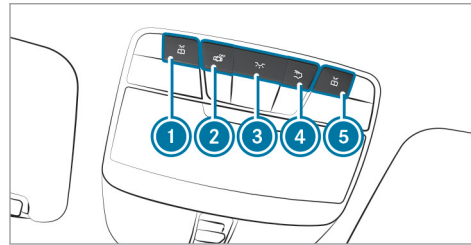

- ① Front left reading lamp
- ② Automatic interior lighting control
- ③ Front interior lighting
- ④ Rear interior lighting
- ⑤ Front right reading lamp

- ▶ **To switch on or off:** press button ① - ⑤ accordingly.

### Adjusting the ambient lighting

Multimedia system:

- ↳ Vehicle ▶ Light Settings
- ▶▶ Ambient Light

#### Setting the color

- ▶ Select **Color**.
- ▶ Set a color.

#### Adjusting the brightness

- ▶ Select **Brightness**.
- ▶ Set a brightness value.

#### Activating the brightness for zones

- ▶ Select **Brightness Zones**.
- ▶ Activate  or deactivate  the function. The **Display**, **Front** and **Rear** zones can be set separately.

### Setting the interior lighting switch-off delay time

Multimedia system:

↳ Vehicle » Light Settings

» Int. Light Switch Off

▶ Set the switch-off delay time.

### Windshield wiper and windshield washer system

#### Switching the windshield wiper on/off

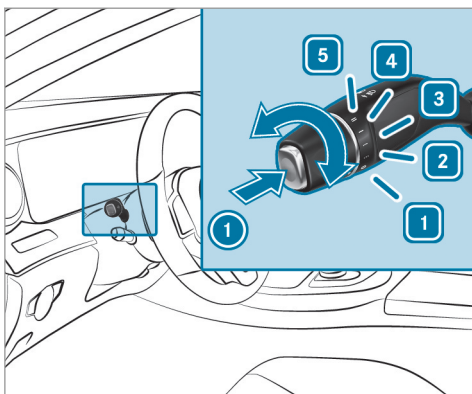

- 1 0 Windshield wiper off
- 2 ... Intermittent wiping, normal
- 3 .... Intermittent wiping, frequent
- 4 — Continuous wiping, slow
- 5 == Continuous wiping, fast

▶ Turn the combination switch to the corresponding position 1 - 5.

▶ **Single wipe/washing:** push the button on the combination switch in the direction of arrow

- ① .
  - Single wipe
  - Wipes with washer fluid

① Observe the notes on washing the vehicle in a car wash (→ page 328).

### Replacing the windshield wiper blades

**⚠ WARNING** Risk of becoming trapped if the windshield wipers are switched on while wiper blades are being replaced

If the windshield wipers begin to move while you are changing the wiper blades, you can be trapped by the wiper arm.

▶ Always switch off the windshield wipers and the ignition before changing the wiper blades.



### Moving the wiper arms into the replacement position

- ▶ Switch the vehicle on and then off again immediately.
- ▶ Within around 15 seconds, press and hold the  button on the combination switch for approximately three seconds (→ page 118). The wiper arms will move into the replacement position.

### Removing the wiper blades

- ▶ Fold the wiper arms away from the windshield.

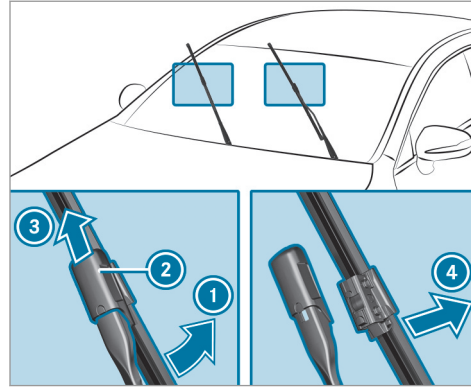

- ▶ Hold the wiper arm with one hand. With the other hand, turn the wiper blade away from the wiper arm in the direction of arrow ① as far as it will go.
- ▶ Slide catch ② in the direction of arrow ③ until it engages in the removal position.
- ▶ Remove the wiper blade from the wiper arm in the direction of arrow ④.

### Installing the wiper blades

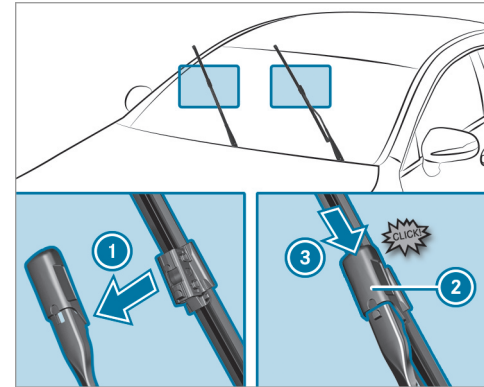

- ▶ Insert the new wiper blade into the wiper arm in the direction of arrow ①.
- ▶ Slide catch ② in the direction of arrow ③ until it engages in the locking position.
- ▶ Make sure that the wiper blade is seated correctly.
- ▶ Fold the wiper arms back onto the windshield.

- ▶ Switch on the vehicle.
  - ▶ Press the  button on the combination switch (→ page 118). The wiper arms will return to their original positions.
  - ▶ Switch off the vehicle.
- ⓘ Check the condition of the wiper blades regularly and replace them in the event of visible damage or ongoing smearing.

### Maintenance display

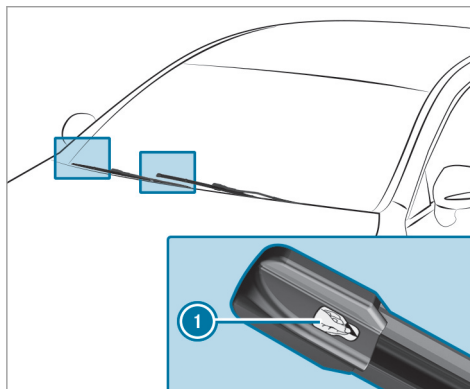

- ▶ Remove protective film ⓘ from the maintenance displays on the tips of the newly installed wiper blades.

When the color of the maintenance displays changes from black to yellow, replace the wiper blades.

- ⓘ The duration until the color changes varies depending on the usage conditions.

## Mirrors

### Operating the outside mirrors

**⚠ WARNING** Risk of accident due to adjusting the vehicle settings while the vehicle is in motion

You could lose control of the vehicle in the following situations in particular:

- If you adjust the driver's seat, the head restraint, the steering wheel or the mirror while the vehicle is in motion
- If you fasten your seat belt while the vehicle is in motion

- ▶ Before starting the engine: In particular, adjust the driver's seat, head restraint, steering wheel and mirror, and fasten your seat belt.

**⚠ WARNING** Risk of accident due to misjudgment of distance when using the front-passenger mirror

The outside mirror on the front passenger side reflects objects on a smaller scale. The objects in view are in fact closer than they appear.

- ▶ Therefore, always look over your shoulder to check the actual distance between you and the road users traveling behind you.

### Folding the outside mirrors in/out

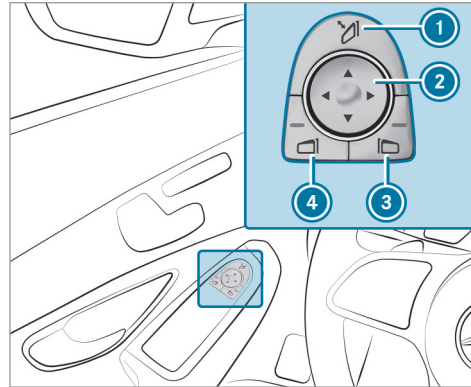

- ▶ Briefly press button ①.

### Resetting the outside mirrors

- ① If the battery has been disconnected or completely discharged, the outside mirrors must be reset. Only then will the automatic mirror folding function work properly.
- ▶ Briefly press button ①.

### Adjusting the outside mirrors

- ▶ Press button ③ or ④ to select the outside mirror to be adjusted.
- ▶ Use button ② to adjust the position of the mirror glass.

### Engaging the outside mirrors

- ▶ **Vehicles without electrically folding outside mirrors:** manually move the outside mirror into the correct position.
- ▶ **Vehicles with electrically folding outside mirrors:** press and hold button ①. You will hear a click and the mirror will audibly click into place. The outside mirror will now be set to the correct position.

### Automatic anti-glare mirror function

**⚠ WARNING** Risk of acid burns and poisoning due to the anti-glare mirror electrolyte

Electrolyte may escape if the glass in an automatic anti-glare mirror breaks.

The electrolyte is hazardous to health and causes irritation. It must not come into contact with your skin, eyes, respiratory organs or clothing or be swallowed.

► If you come into contact with electrolyte, observe the following:

- Immediately rinse the electrolyte from your skin with water and seek medical attention.
- If electrolyte comes into contact with your eyes, immediately rinse them thoroughly with clean water and seek medical attention.
- If the electrolyte is swallowed, immediately rinse your mouth out thoroughly. Do not induce vomiting. Seek medical attention immediately.
- Immediately change out of clothing which has been contaminated with electrolyte.
- If an allergic reaction occurs, seek medical attention immediately.

The inside rearview mirror and the outside mirror on the driver's side will automatically go into anti-glare mode if light from a headlamp hits the sensor on the inside rearview mirror.

#### System limits

The system will not go into anti-glare mode if:

- The vehicle is switched off.
- Reverse gear is engaged.
- The interior lighting is switched on.

#### Front-passenger outside mirror parking position function

The parking position makes parking easier.

The front-passenger outside mirror will swivel downwards in the direction of the rear wheel on the front passenger's side when:

- The parking position is stored (→ page 123).
- The front-passenger mirror is selected.
- Reverse gear is engaged.

The front-passenger outside mirror will move back to its original position when:

- You shift the transmission to another transmission position.
- You are traveling at a speed greater than 9 mph (15 km/h).
- You press the button for the outside mirror on the driver's side.

### Saving the parking position for the front-passenger outside mirror using reverse gear

#### Saving

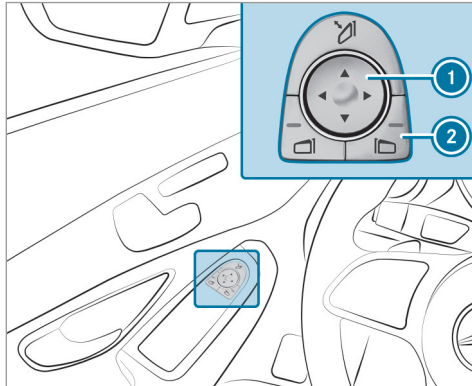

- ▶ Select the front-passenger outside mirror using button ②.
- ▶ Engage reverse gear.
- ▶ Move the front-passenger outside mirror to the desired parking position using button ①.

#### Calling up

- ▶ Select the front-passenger outside mirror using button ②.
- ▶ Engage reverse gear.  
The front-passenger outside mirror will move to the saved parking position.

### Activating/deactivating the automatic mirror folding function

Multimedia system:

- ▶ [Vehicle](#) ▶ [Vehicle Settings](#)
- ▶ [Autom. Mirror Folding](#)
- ▶ Activate  or deactivate  the function.

## Overview of climate control systems

### Notes on climate control

An interior air filter in combination with the prefilter in the engine compartment must always be used so that the air conditioning system, pollution level monitoring and the air filtration work correctly. Use filters recommended and approved by Mercedes-Benz. Always have maintenance work carried out at a qualified specialist workshop.

### Overview of the air conditioning control panel

The indicator lamps on the buttons indicate that the corresponding function is activated.

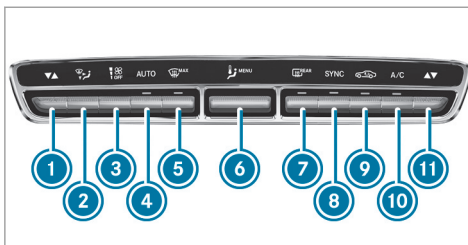

Example: Control panel for dual-zone automatic climate control without stationary heater

- ① Sets the temperature on the driver's side
- ② Sets the air distribution
- ③ Sets the airflow or switches off climate control
- ④ **AUTO** Sets climate control to automatic (→ page 125)
- ⑤ Defrosts the windshield
- ⑥ Vehicles without a stationary heater: calls up the air conditioning menu

Vehicles with a stationary heater: calls up the air conditioning menu, switches residual heat on/off

- ⑦ Switches the rear window heater on/off
- ⑧ Vehicles without a stationary heater: **SYNC** switches synchronization on/off (→ page 125)
- Vehicles with a stationary heater: switches the stationary heater on/off
- ⑨ Switches air-recirculation mode on/off (→ page 125)
- ⑩ **A/C** Switches the A/C function on/off (→ page 125)
- ⑪ Sets the temperature on the front passenger side

## Operating the climate control system

### Switching climate control on/off

- ▶ **To switch on:** set the airflow to level 1 or higher using the button.
- ▶ **To switch off:** set the airflow to level 0 using the button.

If climate control is switched off, the windows may fog up more quickly. Switch climate control off only briefly.

### Switching the A/C function on/off using the air conditioning control panel

The A/C function heats, cools and dehumidifies the vehicle's interior air.



- ▶ Press the  button.

Switch off the A/C function only briefly; otherwise, the windows may fog up more quickly.

Condensation may drip from the underside of the vehicle when cooling mode is active. This is not indicative of a malfunction.

### Setting climate control to automatic mode

In automatic mode, the set temperature is controlled and maintained at a constant level by the air supply.

- ▶ Press button .
- ▶ **To switch to manual mode:** press the  or  button.

### Activating/deactivating the climate control synchronization function via the air conditioning control panel



Climate control can be set centrally using the synchronization function. The temperature and air distribution settings for the driver's side will be adopted automatically for the front passenger side.

- ▶ Press the  button.

The synchronization function will be deactivated if the settings for one of the other climate control zones are changed.

### Defrosting windows

#### Windows fogged up on inside

- ▶ Press the .
- ▶ If the windows remain fogged up: press the .

#### Windows fogged up on outside

- ▶ Switch on the windshield wiper.
- ▶ Press the .

### Switching air-recirculation mode on/off

- ▶ Press the  button.  
The interior air will be recirculated.

Air-recirculation mode automatically switches to fresh air mode after a while.

- ▶  If air-recirculation mode is switched on, the windows may fog up more quickly. Switch on air-recirculation mode only briefly.

### Activating/deactivating ionization

Multimedia system:

- ▶  Vehicle ▶  Climate Control
- ▶ ▶ Ionization

Ionization cleans and refreshes the interior air of the vehicle. Ionization of the interior air is odorless.

- ▶ Activate  or deactivate  the function.

## Fragrance system

### Setting the fragrance system

#### Requirements

- Automatic climate control is activated.
- The glove box is closed.

Multimedia system:

→ [Vehicle](#) →  [Climate Control](#)  
 → [Air Freshener](#)

The fragrance system distributes a pleasant fragrance throughout the vehicle interior from a flacon located in the glove compartment.

- ▶ **To set the intensity:** select **High**, **Medium**, **Low** or **Off**.

### Inserting or removing the flacon of the fragrance system

**⚠ WARNING** Risk of injury from liquid perfume

If children open the flacon, they could drink the liquid perfume or it could come into contact with their eyes.

- ▶ Do not leave children unattended in the vehicle.
- ▶ Consult a doctor immediately if liquid perfume has been drunk.
- ▶ If liquid perfume comes into contact with your eyes or skin, rinse your eyes with clean water.
- ▶ If symptoms continue, consult a doctor.

 **ENVIRONMENTAL NOTE** Environmental damage due to improper disposal of full flacons



Full flacons must not be disposed of with household waste.



Full flacons must be taken to a harmful substance collection point.

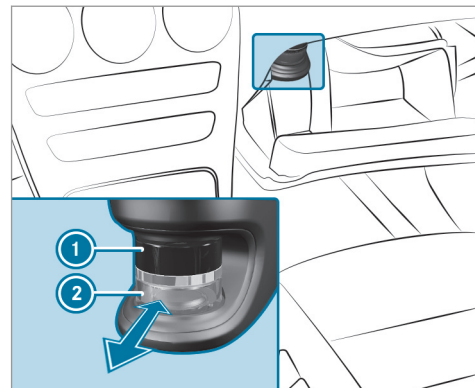

- ▶ **To insert:** slide the flacon into the holder as far as ② it will go.

- ▶ **To remove:** pull out flacon ②.

If you do not use genuine Mercedes-Benz interior perfumes, observe the manufacturers' safety notices on the perfume packaging.



Dispose of the genuine Mercedes-Benz interior perfume flacon when it is empty and do not refill it.

### Refillable flacon

- ▶ Unscrew ① the cap of the ② empty flacon.
- ▶ Fill the flacon with a maximum of ② 0.5 fl. oz. (15 ml).
- ▶ Screw ① the cap back onto ② the flacon.

Always refill the empty refillable flacon with the same perfume. Observe the separate information sheet with the flacon.

### Air vents

#### Adjusting the front air vents

**⚠ WARNING** Risk of burns or frostbite due to being too close to the air vents

Very hot or very cold air can flow from the air vents.

- ▶ Make sure that all vehicle occupants always maintain a sufficient distance from the air vents.
- ▶ If necessary, direct the airflow to another area of the vehicle interior.

To guarantee the flow of fresh air through the air vents into the vehicle interior, note the following:

- Always keep the vents and ventilation grilles in the vehicle interior clear.
- Keep the air inlet free of residue build-up (→ page 328).

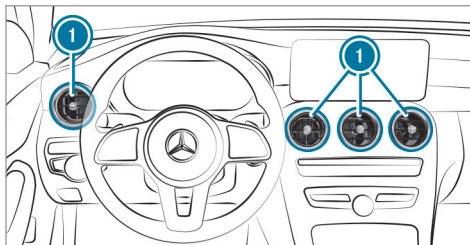

- ▶ **To open or close:** hold the center of air vent ① and turn it to the left (open) or right (closed) as far as it will go.
- ▶ **To set the airflow direction:** hold the center of air vent ① and move it up or down or to the left or right.

#### Adjusting the rear passenger compartment air vents

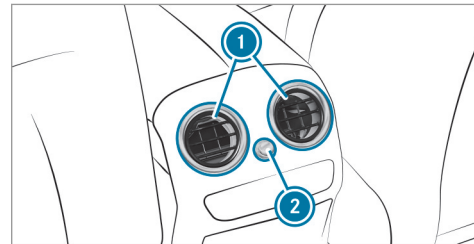

- ▶ **To open or close:** turn controller ② to the left or right as far as it will go.
- ▶ **To set the airflow direction:** hold the center of air vent ① and move it up or down or to the left or right.

## Driving

### Notes on Mercedes-AMG vehicles

Observe the notes on the following topics in the Operating Instructions, otherwise you may fail to recognize dangers.

- ① The availability of certain functions depends on the equipment and model of the vehicle.
- Emotion Start
- Rear axle locking differential
- AMG ceramic high-performance composite brake system
- RACE START
- AMG RIDE CONTROL
- AMG steering-wheel buttons

### Switching on the power supply or the vehicle

**⚠ WARNING** Risk of accident and injury due to children left unattended in the vehicle

If children are left unsupervised in the vehicle, they could, in particular:

- open doors, thereby endangering other persons or road users.
- get out and be struck by oncoming traffic.
- operate vehicle equipment and become trapped, for example.

In addition, the children could also set the vehicle in motion, for example by:

- releasing the parking brake.
- changing the transmission position.
- starting the vehicle.

- ▶ Never leave children unattended in the vehicle.
- ▶ When leaving the vehicle, always take the SmartKey with you and lock the vehicle.

- ▶ Keep the vehicle SmartKey out of reach of children.

### Requirements

- the key is in the vehicle and is detected.
- the brake pedal is not depressed.

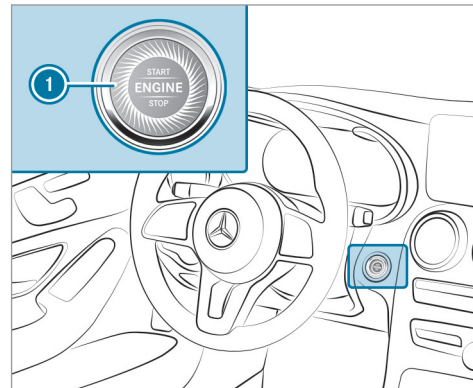

- ▶ **To switch on the power supply:** press button  once.  
You can, for example, switch on the windshield wiper.

The power supply is switched off again if the following conditions are met:

- you open the driver's door.
- you press button  twice more.

- ▶ **To switch on the vehicle:** press button  twice.  
Indicator and warning lamps light up on the instrument cluster.

The vehicle is switched off again if one of the following conditions is met:

- you do not start the vehicle within 15 minutes and the transmission is in position **P** or the electric parking brake is applied.
- you press button  once.

## Starting the vehicle

### Starting the vehicle with the start/stop button

**⚠ DANGER** Risk of death caused by exhaust gases

Combustion engines emit poisonous exhaust gases such as carbon monoxide. Inhaling these exhaust gases is hazardous to health and leads to poisoning.

- ▶ Never leave the engine or, if present, the auxiliary heating running in an enclosed space without sufficient ventilation.





**⚠ WARNING** Risk of fire due to flammable material in the engine compartment or the exhaust system

Flammable materials may ignite.

- ▶ Therefore, check regularly that there are no flammable materials in the engine compartment or on the exhaust system.

### Requirements

- the key is in the vehicle and is detected.

- ▶ Shift the transmission to position **P** or **N**.
  - ▶ Depress the brake pedal and press button  once.
  - ▶ If the vehicle does not start: switch off non-essential consumers and press button  once.
  - ▶ If the vehicle still does not start and the **Place the Key in the Marked Space See Operator's Manual** display message appears on the instrument display: start the vehicle with the key in the marked space (emergency operation mode) (→ page 130).
  -  You can switch off the vehicle while driving. To do this, press button  for about three seconds or press button  three times within three seconds. Be sure to observe the safety notes concerning this under "Driving tips" (→ page 133).
- Observe any information regarding display messages that may be displayed on the instrument display.

### Starting the vehicle with the key in the stowage compartment (emergency operation mode)

If the vehicle does not start and the [Place the Key in the Marked Space](#) See Operator's Manual message appears in the instrument display, you can start the vehicle in emergency operation mode.

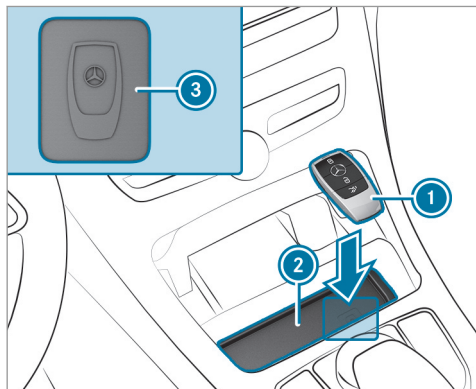

- ▶ Make sure that marked space ② is empty.

- ▶ Remove key ① from the key ring.
- ▶ Place key ① in marked space ② on symbol ③. The vehicle will start after a short time. If you remove key ① from marked space ②, the vehicle can still be driven. For further engine starts however, key ① must be located in marked space ② on symbol ③ during the entire journey.
- ▶ Have key ① checked at a qualified specialist workshop.

#### If the vehicle does not start:

- ▶ Place key ① in marked space ② and leave it there.
- ▶ Depress the brake pedal and start the vehicle using the start/stop button.
- ⓘ You can switch on the power supply or the vehicle with the start/stop button.

Observe any information regarding display messages that can be displayed on the instrument display.

### Starting the vehicle via Remote Online Services

#### Cooling or heating the vehicle interior before starting the journey

Ensure the following before starting the engine:

- The legal stipulations in the area where your vehicle is parked allow engine starting via smartphone.
- It is safe to start and run the engine where your vehicle is parked.
- The fuel tank is sufficiently full.
- The starter battery is sufficiently charged.

#### Charging the starter battery before starting the journey

You can receive a message on your smartphone when the state of charge of the starter battery is low. You can then start the vehicle with the smartphone to charge the battery. The vehicle is automatically switched off after ten minutes.

Ensure the following before starting the engine:

- The legal stipulations in the area where your vehicle is parked allow engine starting via smartphone.

- It is safe to start and run the engine where your vehicle is parked.
- The fuel tank is sufficiently full.

### Starting the vehicle (Remote Online)

**⚠ WARNING** Risk of crushing or entrapment due to unintentional starting of the engine

Limbs could be crushed or trapped if the engine is started unintentionally during service or maintenance work.

- ▶ Always secure the engine against unintentional starting before carrying out maintenance or repair work.



### Requirements

- Park position **P** is selected.
- The anti-theft alarm system is not primed.
- The panic alarm is not activated.
- The hazard warning light system is switched off.
- The hood is closed.
- The doors are closed and locked.
- The windows and sliding sunroof are closed.

- ▶ Start the vehicle using the smartphone. After every engine start, the engine runs for ten minutes.

You can carry out a maximum of two consecutive starting attempts. You must start the engine with the key before trying to start the vehicle again with the smartphone.

You can switch off the vehicle at any time as follows:

- Via the Smartphone App
- By pressing the  or  button on the key
- ⓘ Further information can be found in the smartphone app.

### Securing the vehicle against starting before carrying out maintenance or repair work:

- ▶ Switch on the hazard warning light system.  
or
- ▶ Unlock the doors.  
or

- ▶ Open a side window or the sliding sunroof.

### Breaking-in notes

To preserve the engine during the first 1,000 miles (1,500 km):

- Drive at varying road speeds and engine speeds.
- Do not drive at speeds greater than 85 mph (140 km/h).
- Drive the vehicle in drive program **C** or **E**.
- Shift to the next highest gear no later than when the needle reaches the last third before the red area in the tachometer.
- Do not shift down manually to brake.
- Avoid overstraining the vehicle, e.g. driving at full throttle.
- Do not depress the accelerator pedal past the point of resistance (kickdown).
- Increase the engine speed only gradually and accelerate the vehicle to full speed after 1,000 miles (1,500 km).

This also applies when the engine or parts of the drivetrain have been replaced.

Please also observe the following breaking-in notes:

- In certain driving and driving safety systems, the sensors will adjust automatically while a certain distance is being driven after the vehicle has been delivered or after repairs. Full system effectiveness will not be reached until the end of this teach-in process.
- Brakepads, brake disks and tires that are either new or have been replaced will achieve their optimum braking effect and grip only after several hundred miles of driving. Compensate for the reduced braking effect by applying greater force to the brake pedal.

### Notes on optimized acceleration

If all necessary requirements and activation conditions are fulfilled, the best possible acceleration can be achieved from a standstill.

Do not use optimized acceleration on public roads. Individual wheels could spin and you could

lose control of the vehicle. There is an increased risk of skidding and/or accident.

Be sure to observe the safety notes and information on ESP® (→ page 157).

### Pulling away with optimized acceleration

**⚠ WARNING** Risk of skidding and having an accident from wheels spinning

When you use optimized acceleration, individual wheels could spin and you could lose control of the vehicle.

If ESP® is deactivated, there is a risk of skidding and accident.

- ▶ Make sure that no persons or obstacles are in the close vicinity of your vehicle.

### Requirements

- the vehicle is run in (→ page 131).
- the vehicle and tires are in good condition.
- you are on a high-grip roadway.
- the engine and transmission are at normal operating temperature.

**!** **NOTE** Increased wear due to optimized acceleration

When pulling away with optimized acceleration, all components of the drivetrain are subjected to a very high load.

This can lead to increased component wear.

- ▶ Do not always pull away with optimized acceleration.

- ▶ Engage drive position **D** (→ page 142).
- ▶ Move the steering wheel to the straight-ahead position.
- ▶ Select the sportiest available drive program **S** or **S** (→ page 139).
- ▶ Deactivate ESP® (→ page 159).
- ▶ Depress and hold the brake pedal firmly with your left foot.
- ▶ With your right foot, fully depress the accelerator pedal.

- ▶ After no more than five seconds, take your left foot quickly off the brake, but keep the accelerator pedal depressed. The vehicle will pull away at maximum acceleration.
- ▶ Switch on ESP® once the acceleration procedure is complete.

#### Ending optimized acceleration

- ▶ Remove your foot from the accelerator pedal.
  - ▶ Reactivate ESP®.
- ⓘ After you pull away with optimized acceleration, components of the drivetrain can become very hot, which means that optimized acceleration values may be reached again only after a few minutes.

#### Notes on driving

**⚠ WARNING** Risk of accident due to objects in the driver's footwell

Objects in the driver's footwell may impede pedal travel or block a depressed pedal.

This jeopardizes the operating and road safety of the vehicle.

- ▶ Stow all objects in the vehicle securely so that they cannot get into the driver's footwell.
- ▶ Always install the floor mats securely and as prescribed in order to ensure that there is always sufficient room for the pedals.
- ▶ Do not use loose floor mats and do not place floor mats on top of one another.

**⚠ WARNING** Risk of accident due to incorrect footwear

Incorrect footwear includes, for example:

- Shoes with platform soles
- Shoes with high heels
- Slippers

There is a risk of an accident.

- ▶ Always wear suitable footwear so that you can operate the pedals safely.

**⚠ WARNING** Risk of accident if the vehicle is switched off while driving

If you switch off the vehicle while driving, safety functions are restricted or no longer available.

This may affect the power steering system and the brake force boosting, for example.

You will need to use considerably more force to steer and brake, for example.

- ▶ Do not switch off the vehicle while driving.

**⚠ DANGER** Risk of death caused by exhaust gases

Combustion engines emit poisonous exhaust gases such as carbon monoxide. Inhaling these exhaust gases is hazardous to health and leads to poisoning.

- ▶ Never leave the engine or, if present, the auxiliary heating running in an enclosed space without sufficient ventilation.

**⚠ WARNING** Risk of skidding and of an accident due to shifting down on slippery road surfaces

If you shift down on slippery road surfaces to increase the engine braking effect, the drive wheels may lose traction.

- ▶ Do not shift down on slippery road surfaces to increase the engine braking effect.

**⚠ DANGER** Risk of fatal injury due to poisonous exhaust gases

If the tailpipe is blocked or sufficient ventilation is not possible, poisonous exhaust gases such as carbon monoxide may enter the vehicle. This is the case, for example, if the vehicle gets stuck in the snow.

- ▶ Keep the tailpipe and the area around the vehicle free from snow when the engine or the stationary heater is running.

- ▶ Open a window on the side of the vehicle facing away from the wind to ensure an adequate supply of fresh air.

**⚠ WARNING** Risk of accident and injury due to being under the influence of alcohol and drugs while driving

Drinking and driving and/or taking drugs and driving are very dangerous combinations. Even a small amount of alcohol or drugs can affect your reflexes, perceptions and judgment.

The possibility of a serious or even fatal accident are greatly increased when you drink or take drugs and drive.

- ▶ Do not drink or take drugs and drive or allow anyone to drive who has been drinking or taking drugs.

**⚠ WARNING** Risk of accident due to the brake system overheating

If you leave your foot on the brake pedal when driving, the brake system may overheat.

This increases the braking distance and the brake system can even fail.

- ▶ Never use the brake pedal as a footrest.
- ▶ Do not depress the brake pedal and the accelerator pedal at the same time while driving.

**! NOTE** Engine damage due to excessively high engine speeds

The engine will be damaged if you drive with the engine in the overrevving range.

- ▶ Do not drive with the engine in the overrevving range.

**! NOTE** Wearing out the brake linings by continuously depressing the brake pedal

- ▶ Do not depress the brake pedal continuously whilst driving.
- ▶ To use the braking effect of the engine, shift to a lower gear in good time.



**!** **NOTE** Damage to the drivetrain and engine when pulling away

- ▶ Do not warm up the engine while the vehicle is stationary. Pull away immediately.
- ▶ Avoid high engine speeds and driving at full throttle until the engine has reached its operating temperature.

**!** **NOTE** Damage to the catalytic converter due to non-combusted fuel

The engine is not running smoothly and is misfiring.

Non-combusted fuel may get into the catalytic converter.

- ▶ Only depress the accelerator pedal slightly.
- ▶ Have the cause rectified immediately at a qualified specialist workshop.

**!** **NOTE** Reduced battery life due to frequent short-distance trips

The 12 V battery may not be sufficiently charged when the vehicle is used only for short-distance trips. This reduces the life of the battery.

- ▶ Drive longer distances regularly to charge the battery.

**!** **NOTE** Damage to the vehicle due to not observing the maximum permitted headroom clearance

If the vehicle height is greater than the maximum permitted headroom clearance, the roof and other parts of the vehicle may be damaged.

- ▶ Observe the signposted headroom clearance.
- ▶ If the vehicle height is greater than the permitted headroom clearance, do not enter.

- ▶ Observe the changed vehicle height with add-on roof equipment.

### Notes on driving with a roof load, trailer or fully laden vehicle

When you drive with a loaded roof luggage rack or trailer as well as with a fully laden or fully occupied vehicle, the vehicle's driving and steering characteristics will change.

You should bear the following in mind:

- Do not exceed the permissible roof load and towing capacity. Also observe the technical data in the printed Operator's Manual.
- Evenly distribute the roof load, and place heavy objects at the bottom. Also comply with the notes on loading the vehicle (→ page 99).
- Drive attentively, and avoid suddenly pulling away, braking and steering as well as rapid cornering.

### Notes on driving on salt-treated roads

Braking performance will be limited on salt-treated roads.

Therefore, note the following:

- salt build-up on the brake disks and brakepads may result in braking distances increasing considerably or in braking only on one side
- maintain a much greater safe distance to the vehicle in front

To remove salt build-up:

- brake occasionally while paying attention to the traffic conditions
- carefully depress the brake pedal at the end of the journey and when starting the next journey

### Notes on hydroplaning

Hydroplaning can take place once a certain amount of water has accumulated on the road surface.

Observe the following notes during heavy precipitation or in conditions in which hydroplaning may occur:

- reduce speed
- avoid tire ruts
- avoid sudden steering movements

- brake carefully

**i** Also observe the notes on regularly checking wheels and tires (→ page 357).

### Notes on driving through water on the road surface

Water which has entered into the vehicle can damage the engine, electrics and transmission.

Water can also enter the air intake of the engine and cause engine damage.

Observe the following if you must drive through water:

- The water, when calm, must reach no higher than the lower edge of the vehicle body.
- Drive at a maximum speed of 6 mph (10 km/h); water may otherwise enter the vehicle interior or engine compartment.
- Vehicles traveling in front, or oncoming vehicles, can create waves that may result in the maximum permissible depth of water being exceeded.

Braking performance will be reduced after fording. Brake carefully while paying attention to the

traffic conditions until braking power has been fully restored.

### ECO start/stop function

#### ECO start/stop function

**i** Depending on the engine, the ECO start/stop function is not available in all drive programs. Observe the status display in the instrument display for this.

The engine is switched off automatically in the following situations if all vehicle conditions for an automatic engine stop are met:

- You brake the vehicle to a standstill in transmission position **D** or **N**.

If the system has detected one of the following situations, the engine will not stop:



- You stop at a stop sign and there is no vehicle in front of you.
- The vehicle that stopped in front of you starts up again.
- You maneuver, turn the steering wheel sharply or engage reverse gear.



- i** If the system detects an intelligent stop inhibitor, for example, a stop sign, the engine will not stop.  
If you activate the HOLD function or engage the park position **P**, the engine can be switched off in spite of an intelligent stop inhibitor.

The engine restarts automatically in the following cases:

- You engage transmission position **D** or **R**.
- You depress the accelerator pedal.
- The vehicle requires an automatic engine start.
- You release the brake pedal.

ECO start/stop function symbols in the instrument display:

- The symbol  (green) appears when the vehicle is at a standstill: The engine was switched off by the ECO start/stop function.
- The symbol  (yellow) appears when the vehicle is at a standstill: Not all vehicle conditions for an engine stop have been met.

- Neither the symbol  nor  appears when the vehicle is at a standstill: An intelligent stop inhibitor was detected, e.g. a stop sign.

If the engine was switched off by the ECO start/stop function and you leave the vehicle, a warning tone sounds and the engine is not restarted. In addition, the following display message appears in the instrument display:

#### Vehicle Ready to Drive Switch the Ignition Off Before Exiting

If you do not switch off the vehicle, it is automatically switched off after three minutes.

#### Deactivating or activating the ECO start/stop function

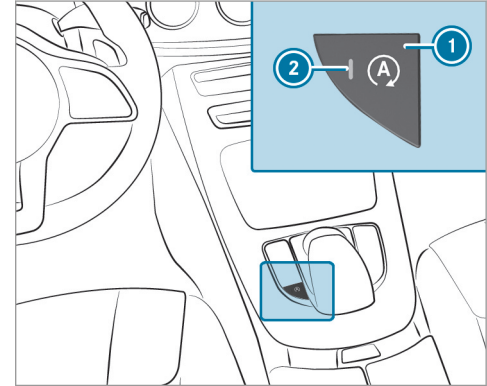

- ▶ Press button **1**.  
If indicator lamp **2** lights up, the ECO start/stop function is activated.
- i** Depending on the model and the vehicle equipment, the button may also be located at a different position in the center console.

## ECO display function

The ECO display summarizes your driving characteristics from the start of the journey to its completion and assists you in achieving the most economical driving style.

You can influence consumption by doing the following:

- Driving with particular care
- Driving the vehicle in drive program **E**
- Observing the gearshift recommendations



The inner segment will light up and the outer segment will fill up when the following driving style is adopted:

- ① Moderate acceleration
- ② Gentle deceleration and rolling
- ③ Consistent speed

The inner segment will not light up and the outer segment will empty when the following driving style is adopted:

- ① Sporty acceleration
- ② Heavy braking
- ③ Fluctuations in speed

The ECO display will show you when you have driven economically:

- The three outer segments are completely filled simultaneously.
- The ECO display lights up.

The additional range achieved as a result of your driving style in comparison with a driver with a very sporty driving style is shown under **Bonus fr.**

**Start.** The range displayed does not indicate a fixed reduction in consumption.

## DYNAMIC SELECT switch

### Function of the DYNAMIC SELECT switch

**!** NOTE Mercedes-AMG vehicles

▶ Observe the notes in the Supplement. You could otherwise fail to recognize dangers.

**i** Depending on the engine and equipment, the vehicle has different drive programs.

Use the DYNAMIC SELECT switch to change between the following drive programs.

The drive program selected appears on the Instrument Display.

**I\*** Individual

- Individual settings

**S\*** Sport+

- Particularly sporty driving

- Emphasizes the vehicle's own oversteer and understeer characteristics for a more active driving style
- Suitable only for good road conditions, a dry surface and a clear stretch of road

#### **S** Sports

- Continues to offer stability but with a sporty setup
- Allows the sporty driver a more active driving style
- Suitable only for good road conditions, a dry surface and a clear stretch of road

#### **C** Comfort

- Comfortable and economical driving
- Balance between traction and stability
- Recommended for all road conditions

#### **E** Eco

- Particularly economical driving
- Balance between traction and stability
- Recommended for all road conditions

**i** The ESP<sup>®</sup> settings in drive programs **E** and **C** are designed for stability. Therefore, choose one of these driving programs, especially when transporting roof loads, in trailer operation and when the vehicle is fully loaded or fully occupied.

Depending on the drive program, the following systems will change their characteristics:

- Drive
  - Engine and transmission management
  - Active Distance Assist DISTRONIC
- ESP<sup>®</sup>
- **Vehicles with AIRMATIC or DYNAMIC BODY CONTROL:** suspension
- Electric power steering

#### Selecting the drive program

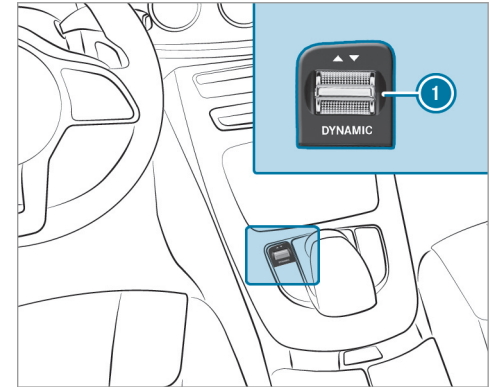

- ▶ Push DYNAMIC SELECT switch **1** forwards or backwards.  
The drive program selected will appear on the Instrument Display.

### Configuring drive program I

Multimedia system:

↳ Vehicle ▶  DYNAMIC SELECT

▶ Individual

▶ Select the individual setting.

### Switching the operation feedback for drive programs on or off

Multimedia system:

↳ Vehicle ▶  DYNAMIC SELECT

▶ Switch **Notification for User** on  or off . When this function is active, a corresponding message is shown in the media display when a drive program is selected with the DYNAMIC SELECT switch.

### To display vehicle data

Multimedia system:

↳ Vehicle ▶  DYNAMIC SELECT

▶ Select **Vehicle Data**.  
The vehicle data is displayed.

### To display engine data

Multimedia system:

↳ Vehicle ▶  DYNAMIC SELECT

▶ Select **Engine Data**.

**i** The actual (maximum) values that can be achieved for engine output and engine torque may deviate from the certified values within the country-specific guidelines for permissible tolerances (basis: UN-ECE No. 85 or country-specific guidelines).

Factors that can influence this are, for example:

- Sea level
- Fuel grade
- Outside temperature
- Operating temperature of the engine

**i** The values displayed serve only as orientation. The values for engine output and engine torque shown in the media display may deviate from the actual values.

### Automatic transmission

#### DIRECT SELECT lever

#### Function of the DIRECT SELECT lever

**⚠ WARNING** Risk of accident due to incorrect gearshifting

If the engine speed is higher than the idle speed and you engage the transmission position **D** or **R**, the vehicle may accelerate sharply.

▶ If you engage the transmission position **D** or **R** when the vehicle is at a standstill, always depress the brake pedal firmly and do not accelerate at the same time.

**⚠ WARNING** Risk of accident and injury due to children left unattended in the vehicle

If children are left unsupervised in the vehicle, they could, in particular:

- open doors, thereby endangering other persons or road users.
- get out and be struck by oncoming traffic.
- operate vehicle equipment and become trapped, for example.

In addition, the children could also set the vehicle in motion, for example by:

- releasing the parking brake.
  - changing the transmission position.
  - starting the vehicle.
- ▶ Never leave children unattended in the vehicle.
  - ▶ When leaving the vehicle, always take the SmartKey with you and lock the vehicle.
  - ▶ Keep the vehicle SmartKey out of reach of children.

Use the DIRECT SELECT lever to switch the transmission position. The current transmission position will be shown on the Instrument Display.

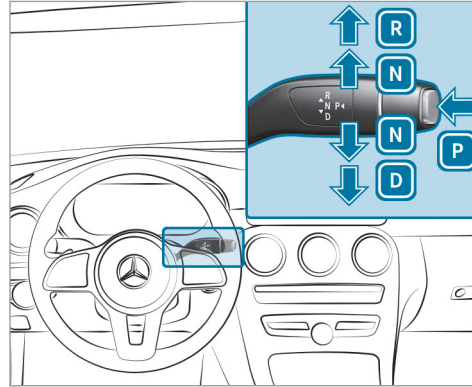

- P** Park position
- R** Reverse gear
- N** Neutral
- D** Drive position

### Engaging reverse gear R

- ▶ Depress the brake pedal and push the DIRECT SELECT lever upwards past the first point of resistance.

### Engaging neutral N

- ▶ Depress the brake pedal and push the DIRECT SELECT lever up or down to the first point of resistance.

- i** To shift into neutral **N** with the vehicle switched on, push the selector lever up or down for several seconds to the first point of resistance.

Subsequently releasing the brake pedal will allow you to move the vehicle freely, e.g. to push it or tow it away.

### Proceed as follows if you want the automatic transmission to remain in neutral **N** even if the vehicle is switched off or the driver's door is opened:

- ▶ Depress the brake pedal and engage neutral **N** when the car is stationary.
- ▶ Release the brake pedal.
- ▶ Switch off the vehicle.

- If you then exit the vehicle leaving the key in the vehicle, the automatic transmission remains in neutral **[N]**.

### Engaging park position P

- ▶ Observe the notes on parking the vehicle (→ page 147).
- ▶ Depress the brake pedal until the vehicle comes to a standstill.
- ▶ When the vehicle is at a standstill, press button **[P]**.  
When the transmission position display shows **[P]**, the park position is engaged. If the transmission position display does not show **[P]**, secure the vehicle to prevent it from rolling away.
- Depending on the situation, it may take a short time until **[P]** is engaged. Therefore, always pay attention to the transmission position display.

Park position **[P]** is engaged automatically if one of the following conditions is met:

- You switch the stationary vehicle off in transmission position **[D]** or **[R]**.

- You open the driver's door when the vehicle is at a standstill or when driving at a very low speed in transmission position **[D]** or **[R]**.

- To maneuver with an open driver's door, open the driver's door while at a standstill and engage transmission position **[D]** or **[R]** again.

### Engaging drive position D

- ▶ Depress the brake pedal and push the DIRECT SELECT lever down past the first point of resistance.

When the automatic transmission is in transmission position **[D]**, it will shift gears automatically. This depends, among other things, on the following factors:

- The drive program selected
- The position of the accelerator pedal
- The driving speed

## Problems with the transmission

### The transmission has a faulty gear shift

Possible cause:

- the transmission is losing oil.
- ▶ Have the transmission checked at a qualified specialist workshop immediately.

### The acceleration characteristics worsen, and the transmission no longer shifts.

Possible cause:

- the transmission is in emergency operation mode: it is possible to shift only to one gear and reverse gear.
- ▶ Stop the vehicle in accordance with the traffic conditions.
- ▶ Shift the transmission to position **[P]**.
- ▶ Switch off the vehicle.
- ▶ Wait at least ten seconds.
- ▶ Start the vehicle again.



- ▶ Shift the transmission to position **D** or **R**. If **D** is selected, the transmission will shift only to one gear; if **R** is selected, the transmission will shift to reverse gear.
- ▶ Have the transmission checked at a qualified specialist workshop immediately.

### Manual gearshifting

#### **!** NOTE Mercedes-AMG vehicles

- ▶ Observe the notes in the Supplement. You could otherwise fail to recognize dangers.

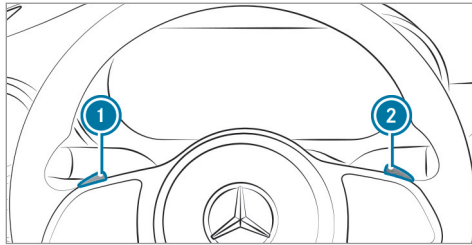

When the automatic transmission is shifted to position **D**, you can manually shift it with the steering wheel paddle shifter. If permitted, the automatic transmission will shift to a higher or lower gear depending on the steering wheel paddle shifter being pulled.

You have two options for manually shifting the automatic transmission:

- Temporary setting
- Permanent setting

The gears will shift automatically when manual shifting is deactivated.

#### Temporary setting:

- ▶ **To activate:** pull steering wheel paddle shifter **1** or **2**. Manual shifting will be activated for a short time. The transmission position display will show **M** and the current gear.
- i** How long manual shifting stays activated depends on various factors.

Manual shifting can be deactivated automatically in the following cases:

- When the drive program is changed
- When the vehicle is restarted
- When transmission position **D** is engaged again
- When the driving style prompts it

- ▶ **To shift up:** pull steering wheel paddle shifter **2**.
- ▶ **To shift down:** pull steering wheel paddle shifter **1**.
- ▶ **To deactivate:** pull and hold steering wheel paddle shifter **2**. The transmission position display will show **D**.

### Gearshift recommendation

The gearshift recommendation assists you in adopting an economical driving style.

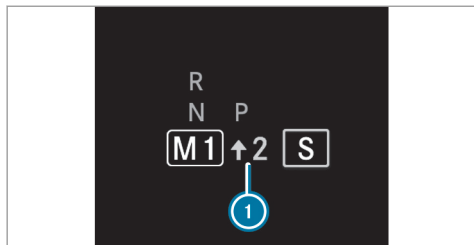

- ▶ If gearshift recommendation **1** appears next to the transmission position display, shift to the recommended gear.

### Using kickdown

- ▶ **Maximum acceleration:** depress the accelerator pedal beyond the point of resistance.

To protect against engine overrev, the automatic transmission will shift up to the next gear when maximum engine speed has been reached.

### Glide mode function

#### ! NOTE Mercedes-AMG vehicles

- ▶ Observe the notes in the Supplement. You could otherwise fail to recognize dangers.

With an anticipatory driving style, Glide mode helps you to reduce fuel consumption.

Glide mode is characterized by the following:

- The combustion engine is disconnected from the drivetrain and continues to run in neutral.
- The transmission position display **D** is shown in green.

Glide mode is activated if the following conditions are met:

- Drive program **E** is selected.
- The speed is within a suitable range.
- The road's course is suitable, e.g. no steep uphill or downhill inclines or tight bends.
- You do not depress the accelerator or brake pedal (except for light brake applications).

- ⓘ Glide mode can also be activated if you have selected the "Eco" setting for the drive in the drive program **1\***.

Glide mode is deactivated again if one of the conditions is no longer met.

Glide mode can also be prevented by the following parameters:

- Incline
- Downhill gradient
- Temperature
- Height
- Speed
- Operating status of the engine
- Traffic situation

- ⓘ Glide mode can be ended by pressing a steering wheel paddle shifter (→ page 143).

### Function of the 4MATIC

4MATIC ensures that all four wheels are driven. Together with ESP® and 4ETS, 4MATIC improves

the traction of your vehicle whenever a driven wheel spins due to insufficient traction.

If you fail to adapt your driving style, 4MATIC can neither reduce the risk of an accident nor override the laws of physics. 4MATIC cannot take account of road, weather and traffic conditions. 4MATIC is only an aid. You are responsible especially for maintaining a safe distance from the vehicle in front, for vehicle speed, for braking in good time and for staying in lane.

- ① In wintry road conditions, the maximum effect of 4MATIC can be achieved only if you use winter tires (M+S tires), with snow chains if necessary.

## Refueling

### Refueling the vehicle

**⚠ WARNING** Risk of fire or explosion from fuel

Fuels are highly flammable.

- ▶ Fire, open flames, smoking and creating sparks must be avoided.
- ▶ Before refueling, switch off the vehicle and, if installed, the stationary heater, and leave them switched off during refueling.

**⚠ WARNING** Risk of injury from fuels

Fuels are poisonous and hazardous to your health.

- ▶ Do not swallow fuel or let it come into contact with skin, eyes or clothing.
- ▶ Do not inhale fuel vapor.
- ▶ Keep children away from fuel.
- ▶ Keep doors and windows closed during the refueling process.

If you or other people come into contact with fuel, observe the following:

- ▶ Immediately rinse fuel off your skin with soap and water.
- ▶ If fuel comes into contact with your eyes, immediately rinse them thoroughly with

clean water. Seek medical attention immediately.

- ▶ If you swallow fuel, seek medical attention immediately. Do not induce vomiting.
- ▶ Change immediately out of clothing that has come into contact with fuel.

**⚠ WARNING** Risk of fire and explosion due to electrostatic charge

Electrostatic charge can ignite fuel vapor.

- ▶ Before you open the fuel filler cap or take hold of the pump nozzle, touch the metallic vehicle body.
- ▶ To avoid creating another electrostatic charge, do not get into the vehicle again during the refueling process.

**!** **NOTE** Damage caused by the wrong fuel

Vehicles with a gasoline engine:

Even small amounts of the wrong fuel could result in damage to the fuel system, the engine and the emission control system.

- ▶ Only refuel with low-sulfur spark-ignition engine fuel.

This fuel may contain up to 10% ethanol. Your vehicle is suitable for use with E10 fuel.

Never refuel with one of the following fuels:

- Diesel
- Gasoline with more than 10% ethanol by volume, e.g. E15, E85, E100
- Gasoline with more than 3% methanol by volume, e.g. M15, M30, M85, M100
- Gasoline with additives containing metal

If you have accidentally refueled with the wrong fuel:

- ▶ Do not switch on the vehicle.
- ▶ Consult a qualified specialist workshop.

**!** **NOTE** Do not use diesel to refuel vehicles with a gasoline engine

If you have accidentally refueled with the wrong fuel:

- Do not switch on the vehicle. Otherwise fuel can enter the engine.

Even small amounts of the wrong fuel could result in damage to the fuel system and the engine. The repair costs are high.

- ▶ Consult a qualified specialist workshop.
- ▶ Have the fuel tank and fuel lines drained completely.

**!** **NOTE** Damage to the fuel system caused by overfilled fuel tanks

- ▶ Only fill the fuel tank until the pump nozzle switches off.

**!** **NOTE** Fuel may spray out when you remove the fuel pump nozzle

- ▶ Only fill the fuel tank until the pump nozzle switches off.

#### Requirements

- The vehicle is unlocked.

Observe the notes on operating fluids and fuel.

Only refuel with fuel that has at least the octane number specified in the information label in the fuel filler flap. Otherwise, engine output can be reduced and fuel consumption increased.

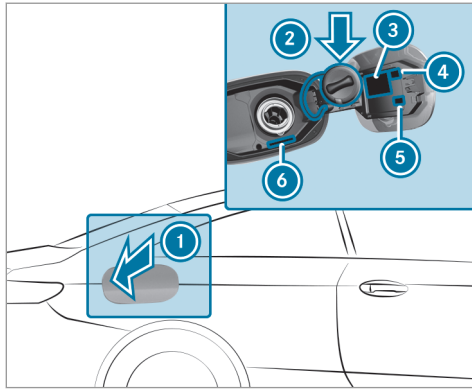

- ① Fuel filler flap
- ② Bracket for fuel filler cap
- ③ Tire pressure table
- ④ QR code for rescue card
- ⑤ Stationary heater indication
- ⑥ Fuel type

▶ Press on the back area of fuel filler flap ①.

- ▶ Turn the fuel filler cap counter-clockwise and remove it.
- ▶ Insert fuel filler cap from above into bracket ②.
- ▶ Completely insert the pump nozzle into the tank filler neck, hook in place and refuel.
- ▶ Only fill the fuel tank until the pump nozzle switches off.
- ▶ Replace the cap on the filler neck and turn clockwise until it engages audibly.
- ▶ Close fuel filler flap ①.

## Parking

### Parking the vehicle

- ⚠ **WARNING** Risk of accident and injury caused by an insufficiently secured vehicle rolling away

If the vehicle is not securely parked sufficiently, it can roll away in an uncontrolled way even at a slight downhill gradient.

- ▶ On uphill or downhill gradients, turn the front wheels so that the vehicle rolls towards the curb if it starts moving.
- ▶ Apply the parking brake.
- ▶ Switch the transmission to position **P**.

- ⚠ **WARNING** Risk of fire caused by hot exhaust system parts

Flammable materials such as leaves, grass or twigs may ignite.

- ▶ Park the vehicle so that no flammable material can come into contact with hot vehicle components.
- ▶ In particular, do not park on dry grass-land or harvested grain fields.

**⚠ WARNING** Risk of accident and injury due to children left unattended in the vehicle

If children are left unsupervised in the vehicle, they could, in particular:

- open doors, thereby endangering other persons or road users.
- get out and be struck by oncoming traffic.
- operate vehicle equipment and become trapped, for example.

In addition, the children could also set the vehicle in motion, for example by:

- releasing the parking brake.
  - changing the transmission position.
  - starting the vehicle.
- ▶ Never leave children unattended in the vehicle.
- ▶ When leaving the vehicle, always take the SmartKey with you and lock the vehicle.
- ▶ Keep the vehicle SmartKey out of reach of children.

**! NOTE** Damage to the vehicle due to it rolling away

- ▶ Always secure the vehicle against rolling away.

**! NOTE** Damage due to the vehicle lowering

**Vehicles with AIRMATIC or level control:** The vehicle can lower because of temperature differences or longer non-operational times. This can cause damage to parts of the body.

- ▶ When stopping the vehicle and when driving off, make sure that there are no obstacles such as curbs under or in the immediate vicinity of the body.

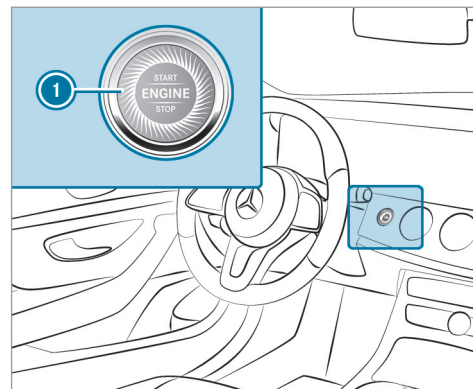

- ▶ Bring the vehicle to a standstill by pressing the brake pedal.
- ▶ On gradients, turn the front wheels so that the vehicle will roll towards the curb if it starts moving.
- ▶ Apply the electric parking brake.

- ▶ Engage transmission position **P** in a stationary vehicle with the brake pedal depressed (→ page 142).
  - ▶ Switch off the vehicle by pressing button **1**.
  - ▶ Release the service brake slowly.
  - ▶ Get out of the vehicle and lock it.
- i** When you park the vehicle, you can still operate the side windows and the panoramic sliding sunroof for approximately four minutes if the driver's door is closed.

### Garage door opener

#### Programming buttons for the garage door opener

**⚠ DANGER** Risk of death caused by exhaust gases

Combustion engines emit poisonous exhaust gases such as carbon monoxide. Inhaling these exhaust gases is hazardous to health and leads to poisoning.

- ▶ Never leave the engine or, if present, the auxiliary heating running in an enclosed space without sufficient ventilation.

**⚠ WARNING** Risk of injury by becoming trapped when opening and closing a garage door

When you operate or program a garage door with an integrated garage door opener, persons can become trapped or struck by the garage door if they stand within its range of movement.

- ▶ Always make sure that nobody is within the range of the garage door's movement.

Only operate the following doors using the garage door opener:

- Doors with a safety stop and reversing function
- Doors that conform to the current U.S. safety standards

Before programming the garage door opener, park the vehicle outside the garage. Make sure that the vehicle is switched on but not started.

#### Requirements

- The vehicle has been parked outside the garage or outside the range of movement of the door.
  - The vehicle is switched on.
  - The vehicle has not been started.
- i** The garage door opener function is always available when the vehicle is switched on.

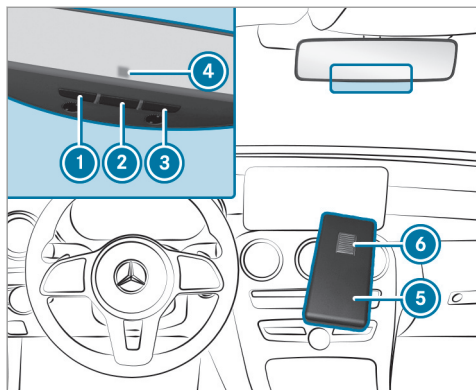

- ▶ Check that the transmitter frequency of the remote control has a frequency range of 280 to 868 MHz.

Radio equipment approval number:

- NZLMUAHL5 (USA)
- 4112A-MUAHL5 (Canada)

- ▶ Press and hold button ①, ② or ③ that you wish to program. Indicator lamp ④ will flash yellow.
- ⓘ It can take up to 20 seconds before the indicator lamp flashes yellow.
- ▶ Release the button previously pressed. Indicator lamp ④ will continue to flash yellow.
- ▶ Point remote control ⑤ from a distance of 0.4 in (1 cm) to 3 in (8 cm) towards button ①, ② or ③.
- ▶ Press and hold button ⑥ of remote control ⑤ until one of the following signals appears:
  - Indicator lamp ④ lights up green continuously. Programming is complete.
  - Indicator lamp ④ flashes green. Programming was successful. Additionally, the rolling code must be synchronized with the door system.
- ▶ If indicator lamp ④ does not light up or flash green: repeat the procedure.
- ▶ Release all of the buttons.

- ⓘ The remote control for the door drive is not included in the scope of delivery of the garage door opener.

### Synchronizing the rolling code

#### Requirements

- The door system uses a rolling code.
- The vehicle must be within range of the garage door or door drive.
- The vehicle as well as persons and objects are located outside the range of movement of the door.
- ▶ Press the programming button on the door drive unit. Initiate the next step within approximately 30 seconds.
- ▶ Press previously programmed button ①, ② or ③ repeatedly until the door closes. When the door closes, programming is completed.
- ⓘ Please also read the operating instructions for the door drive.



### Troubleshooting when programming the remote control

- ▶ Check that the transmitter frequency of remote control ⑤ is supported.
  - ▶ Replace the batteries in remote control ⑤.
  - ▶ Hold remote control ⑤ at various angles from a distance of 0.4 in (1 cm) to 3 in (8 cm) front of the inside rearview mirror. You should test every setting position for at least 25 seconds before trying another position.
  - ▶ Hold remote control ⑤ at the same angles at various distances in front of the inside rearview mirror. You should test every setting position for at least 25 seconds before trying another position.
  - ▶ On remote controls that transmit only for a limited period, press button ④ on remote control ⑤ again before transmission ends.
  - ▶ Angle the antenna line of the garage door opener unit towards the remote control.
- ① It is possible that older garage doors cannot be operated using the remote control in the inside rearview mirror even after you have successfully performed the measures descri-

bed above. If this is the case, contact the HomeLink® Hotline.

- ① Support and additional information on programming:
  - Via the toll free HomeLink® Hotline on 1-800-355-3515
  - On the Internet at the <https://www.homelink.com/mercedes>

### Opening or closing a garage door

#### Requirements

- The corresponding button is programmed to operate the door.
- ▶ Press and hold button ①, ② or ③ until the door opens or closes.
  - ▶ If indicator lamp ④ flashes yellow after approximately 20 seconds: press and hold the button previously pressed again until the door opens or closes.

### Clearing the garage door opener memory

- ▶ Press and hold buttons ① and ③. Indicator lamp ④ will light up yellow.

- ▶ If indicator lamp ④ flashes green: release buttons ① and ③. The entire memory has been deleted.

### Electric parking brake

#### Function of the electric parking brake (applying automatically)

**⚠ WARNING** Risk of accident and injury due to children left unattended in the vehicle

If children are left unsupervised in the vehicle, they could, in particular:

- open doors, thereby endangering other persons or road users.
- get out and be struck by oncoming traffic.
- operate vehicle equipment and become trapped, for example.

In addition, the children could also set the vehicle in motion, for example by:

- releasing the parking brake.
- changing the transmission position.

- starting the vehicle.
- ▶ Never leave children unattended in the vehicle.
- ▶ When leaving the vehicle, always take the SmartKey with you and lock the vehicle.
- ▶ Keep the vehicle SmartKey out of reach of children.

**The electric parking brake is applied if the transmission is in position **P** and one of the following conditions is fulfilled:**

- The vehicle is switched off.
- The seat belt tongue is not inserted in the seat belt buckle of the driver's seat and the driver's door is opened.

**i** To prevent application: pull the handle of the electric parking brake (→ page 153).

**In the following situations, the electric parking brake is also applied:**

- The HOLD function is keeping the vehicle stationary.

- Active Parking Assist is keeping the vehicle stationary.
- Active Distance Assist DISTRONIC is bringing the vehicle to a standstill.
- **In addition, one of the following conditions must be fulfilled:**
  - The vehicle is switched off.
  - The seat belt tongue is not inserted in the seat belt buckle of the driver's seat and the driver's door is opened.
  - There is a system malfunction.
  - The power supply is insufficient.
  - The vehicle is stationary for a lengthy period.

When the electric parking brake is applied, the red **PARK** (USA) or **(P)** (Canada) indicator lamp lights up in the instrument cluster.

**i** The electric parking brake is not automatically applied if the vehicle is switched off by the ECO start/stop function.

**Function of the electric parking brake (releasing automatically)**

**The electric parking brake is released when the following conditions are fulfilled:**

- The driver's door is closed.
- The vehicle has been started.
- The transmission is in position **D** or **R** and you depress the accelerator pedal or you shift from transmission position **P** to **D** or **R** when on level ground.
- If the transmission is in position **R**, the trunk lid must be closed.
- The seat belt tongue is inserted into the seat belt buckle of the driver's seat.

If the seat belt tongue is not inserted into the seat belt buckle of the driver's seat, one of the following conditions must be fulfilled:

- You shift from transmission position **P**.  
or
- You have previously driven at speeds greater than 2 mph (3 km/h).

When the electric parking brake is released, the red **PARK** (USA) or **(P)** (Canada) indicator lamp in the instrument cluster goes out.

### Applying/releasing the electric parking brake manually

#### Applying

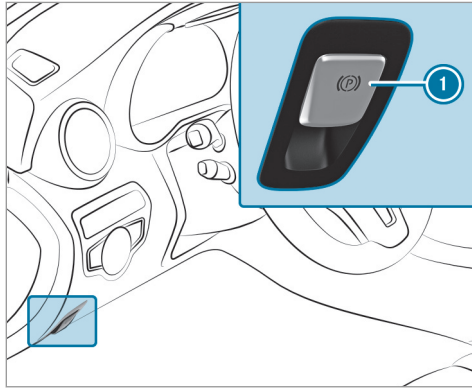

- ▶ Push handle ①.

The red **PARK** (USA) or **(P)** (Canada) indicator lamp lights up in the instrument cluster.

- ① The electric parking brake is only securely applied if the red **PARK** (USA) or **(P)** (Canada) indicator lamp is lit continuously.

#### Releasing

- ▶ Switch on the vehicle.

- ▶ Pull handle ①.

The red **PARK** (USA) or **(P)** (Canada) indicator lamp in the instrument cluster goes out.

#### Emergency braking

- ▶ Press and hold handle ①.

As long as the vehicle is driving, the **Please Release Parking Brake** message is displayed and the red **PARK** (USA) or **(P)** (Canada) indicator lamp flashes.

When the vehicle has been braked to a standstill, the electric parking brake is applied. The red **PARK** (USA) or **(P)** (Canada) indicator lamp lights up in the instrument cluster.

### Information on collision detection when a vehicle is parked

If a collision is detected when the tow-away alarm is armed on a locked vehicle, you will receive a notification in the multimedia system when you switch the vehicle on.

You will receive information about the following points:

- The area of the vehicle that may have been damaged.
- The force of the impact.

The following situation can lead to inadvertent activation:

- The parked vehicle is moved, for example, in a two-story garage.
- ① Deactivate the tow-away alarm in order to prevent inadvertent activation. If you deactivate the tow-away alarm, collision detection will also be deactivated.

- ⓘ If the battery is severely discharged, the function for detecting a collision with a parked vehicle will automatically be deactivated to facilitate the next engine start.

### System limits

Detection may be restricted in the following situations:

- The vehicle is damaged without an impact, for example, if an outside mirror is torn off or the paint is damaged by a key
  - An impact occurs at low speed
  - The electric parking brake is not applied
- ⓘ You are responsible for your vehicle. Therefore, always make sure that your vehicle is free of damage and is roadworthy.

### Notes on parking the vehicle for an extended period

If you leave the vehicle parked for longer than six weeks, it may suffer damage through disuse.

The 12 V battery may also be impaired or damaged by heavy discharging.

- ⓘ Further information can be obtained at a qualified specialist workshop.

### Standby mode (extension of the starter battery's period out of use)

#### Standby mode function

- ⓘ This function is not available for all models.

If standby mode is activated, energy loss will be minimized during extended periods of non-operation.

Standby mode is characterized by the following:

- The starter battery is preserved.
- The maximum non-operational time appears in the media display.
- The connection to online services is interrupted.
- The ATA (anti-theft alarm system) is not available.
- The interior protection and tow-away alarm functions are not available.
- The function for detecting collisions on a parked vehicle is not available.

If the following conditions are fulfilled, standby mode can be activated or deactivated using the multimedia system:

- The vehicle is switched on.
- The vehicle has not been started.

Exceeding the vehicle's displayed non-operational time may cause inconvenience; i.e. it cannot be guaranteed that the starter battery will reliably start the vehicle.

Charge the starter battery in the following situations:

- The vehicle's non-operational time must be extended.
- The **Battery Charge Insufficient for Standby Mode** message appears in the media display.

- ⓘ Standby mode is automatically deactivated when the vehicle is switched on.

#### Activating/deactivating standby mode

Multimedia system:

➤ **Vehicle** ➤  **Vehicle Settings**  
➤ **Standby Mode**

- ⓘ This function is not available for all models.

- ▶ Activate  or deactivate  the function. When you activate the function, a prompt will appear.
- ▶ Select **Yes**. Standby mode will be activated.

### Driving and driving safety systems

#### Driving systems and your responsibility

Your vehicle is equipped with driving systems that assist you in driving, parking and maneuvering the vehicle. The driving systems are only aids. They are not a substitute for you paying attention to your surroundings and do not relieve you of your responsibility pertaining to road traffic law. The driver is always responsible for maintaining a safe distance, for vehicle speed, for braking in good time and for staying in lane. Pay attention to the traffic conditions at all times and intervene when necessary. Be aware of the limitations regarding the safe use of these systems.

Driving systems can neither reduce the risk of accident if you fail to adapt your driving style nor override the laws of physics. They cannot always

take into account road, weather or traffic conditions.

#### Information on vehicle sensors and cameras

Some driving and driving safety systems use cameras as well as radar or ultrasonic sensors to monitor the area in front of, behind or next to the vehicle.

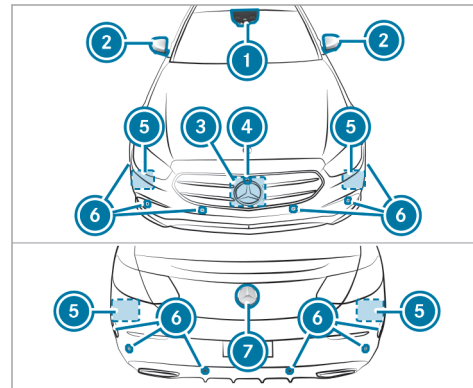

- ① Multifunction camera
- ② Cameras in the outside mirrors
- ③ Front radar
- ④ Front camera
- ⑤ Corner radars
- ⑥ Ultrasonic sensors
- ⑦ Rear-view camera

**⚠ WARNING** Risk of accident due to restricted detection performance of vehicle sensors and cameras

If the area around vehicle sensors or cameras is covered, damaged or dirty, certain driving and safety systems cannot function correctly. There is a risk of an accident.

- ▶ Keep the area around vehicle sensors or cameras clear of any obstructions and clean.
- ▶ Have damage to the bumper, radiator grille or stone chipping in the area of the front and rear windows repaired at a qualified specialist workshop.

In particular, keep the areas around the sensors and cameras free of dirt, ice or slush (→ page 332). The sensors and cameras must not be covered and the detection ranges around them must be kept free. Do not attach any additional license plate brackets, advertisements, stickers or foils – including those protecting against stone chippings – in the detection range of the sensors and cameras. Make sure that there are no overhanging loads protruding into the detection range.

If the bumper or radiator grille is damaged or after an impact, have the function of the sensors checked at a qualified specialist workshop. Have damage or stone chipping in the area of the cameras on the front and rear windows repaired at a qualified specialist workshop.

### Overview of driving systems and driving safety systems

- ABS (**A**nti-**l**ock **B**raking **S**ystem) (→ page 157)
- BAS (**B**rake **A**ssist **S**ystem) (→ page 157)
- ESP® (**E**lectronic **S**tability **P**rogram) (→ page 157)
- ESP® Crosswind Assist (→ page 158)
- EBD (**E**lectronic **B**rakeforce **D**istribution) (→ page 159)
- STEER CONTROL (→ page 159)
- HOLD function (→ page 159)
- Hill Start Assist (→ page 160)
- ATTENTION ASSIST (→ page 161)
- Cruise control (→ page 162)
- Traffic Sign Assist (→ page 180)
- DYNAMIC BODY CONTROL (→ page 187)
- AIRMATIC (→ page 187)
- Route-based speed adaptation (country-dependent) (→ page 169)
- Active Brake Assist (→ page 175)
- Active Steering Assist (country-dependent) (→ page 170)
- Active Emergency Stop Assist (country-dependent) (→ page 173)
- Active Lane Change Assist (country-dependent) (→ page 174)
- Blind Spot Assist and Active Blind Spot Assist with exit warning (→ page 181)
- Active Lane Keeping Assist (→ page 184)

### **Driving Assistance package**

The following functions are part of the Driving Assistance Package. Certain functions are only available in some countries. Some functions are also available without the Driving Assistance Package, albeit with restricted functionality.

- Active Distance Assist DISTRONIC (→ page 164)
- Active Speed Limit Assist (country-dependent) (→ page 168)

### **Parking Package**

- Reversing camera (→ page 189)
- 360° Camera (→ page 191)
- Parking Assist PARKTRONIC (→ page 194)
- Active Parking Assist (→ page 198)

## Functions of ABS

The Anti-lock Brake System (ABS) regulates the brake pressure in critical driving situations:

- During braking (e.g. at maximum full-stop braking or if there is insufficient tire traction), the wheels are prevented from locking.
- Vehicle steerability while braking is ensured.

If ABS intervenes when braking, you will feel a pulsing in the brake pedal. The pulsating brake pedal can be an indication of hazardous road conditions and can serve as a reminder to take extra care while driving.

### System limits

- ABS is active from speeds of approx. 3 mph (5 km/h).
- ABS may be impaired or may not function if a malfunction has occurred and the yellow  ABS warning lamp lights up continuously after the vehicle is started.

## Function of BAS

**⚠ WARNING** Risk of an accident caused by a malfunction in BAS (Brake Assist System)

If BAS is malfunctioning, the braking distance in an emergency braking situation is increased.

- ▶ Depress the brake pedal with full force in emergency braking situations. ABS prevents the wheels from locking.

The Brake Assist System (BAS) supports your emergency braking situation with additional brake force.

If you depress the brake pedal quickly, BAS is activated:

- BAS automatically boosts the brake pressure.
- BAS can shorten the braking distance.
- ABS prevents the wheels from locking.

The brakes will function as usual once you release the brake pedal. BAS is deactivated.

## Function of ESP®

**⚠ WARNING** Risk of skidding if ESP® is deactivated

If you deactivate ESP®, ESP® cannot carry out vehicle stabilization.

- ▶ ESP® should only be deactivated in the following situations.

**!** **NOTE** Mercedes-AMG vehicles

- ▶ Observe the notes in the Supplement. You could otherwise fail to recognize dangers.

The Electronic Stability Program (ESP®) can monitor and improve driving stability and traction in the following situations within physical limits:

- When pulling away on wet or slippery roads.
- When braking.

If the vehicle deviates from the direction desired by the driver, ESP® can stabilize the vehicle by intervening in the following ways:

- One or more wheels are braked.
- The engine output is adapted according to the situation.

When ESP® is deactivated, the  warning lamp lights up continuously:

- Driving stability will no longer be improved.
- The driven wheels could spin.
- ETS/4ETS traction control is still active.

 When ESP® is deactivated, you will still be assisted by ESP® when braking.

When the  warning lamp flashes, one or several wheels has reached its grip limit:

- Adapt your driving style to suit the current road and weather conditions.
- Do not deactivate ESP® under any circumstances.
- Only depress the accelerator pedal as far as is necessary when pulling away.

Deactivate ESP® in the following situations to improve traction:

- When using snow chains.
- In deep snow.
- On sand or gravel.

 Spinning the wheels results in a cutting action, which enhances traction.

If the ESP® warning lamp  lights up continuously, ESP® is not available due to a malfunction.

Observe the following information:

- Indicator and warning lamps (→ page 450)
- Display messages (→ page 400)

### ETS/4ETS (Electronic Traction System)

ETS/4ETS traction control is part of ESP® and makes it possible to pull away and accelerate on a slippery road.

ETS/4ETS can improve the vehicle's traction by intervening in the following ways:

- The driven wheels are braked individually if they spin.

- More drive torque is transferred to the wheel or wheels with traction.

### Influence of drive programs on ESP®

The drive programs enable ESP® to adapt to different weather and road conditions as well as the driver's preferred driving style. Depending on the selected drive program, the appropriate ESP® mode will be activated. You can select the drive programs using the DYNAMIC SELECT switch (→ page 139).

### Function of ESP® Crosswind Assist

ESP® Crosswind Assist detects sudden gusts of side wind and helps the driver to keep the vehicle in the lane:

- ESP® Crosswind Assist is active at vehicle speeds between approx. 47 mph (75 km/h) and 125 mph (200 km/h) when driving straight ahead or cornering slightly.
- The vehicle is stabilized by means of individual brake application on one side.



### Activating/deactivating ESP® (Electronic Stability Program)

Multimedia system:

→ Vehicle →  Assistance → ESP

**Mercedes-AMG vehicles:** observe the notes in the Supplement. You could otherwise fail to recognize dangers.

▶ Activate  or deactivate  the function.

ESP® is deactivated if the ESP® OFF warning lamp  lights up continuously on the instrument cluster.

Observe the information on warning lamps and display messages that may be shown on the instrument cluster.

### Function of EBD

Electronic Brakeforce Distribution (EBD) is characterized by the following:

- Monitoring and regulating the brake pressure on the rear wheels.

- Improved driving stability when braking, especially on bends.

### Function of STEER CONTROL

STEER CONTROL assists you by transmitting a noticeable steering force to the steering wheel in the direction required for vehicle stabilization.

This steering recommendation is given in the following situations:

- both right wheels or both left wheels are on a wet or slippery road surface when you brake
- the vehicle starts to skid

### System limits

STEER CONTROL may be impaired or may not function in the following situations:

- ESP® is deactivated.
- ESP® is malfunctioning.
- The steering is malfunctioning.

If ESP® is malfunctioning, you will be assisted further by the electric power steering.

### HOLD function

#### HOLD function

The HOLD function holds the vehicle at a standstill without requiring you to depress the brake pedal, e.g. while waiting in traffic.

The HOLD function is only an aid. The responsibility for the vehicle safely standing still remains with the driver.

#### System limits

The HOLD function is only intended to provide assistance when driving and is not a sufficient means of safeguarding the vehicle against rolling away when stationary.

- The incline must not be greater than 30%.

### Activating/deactivating the HOLD function

**⚠ WARNING** Risk of an accident due to the HOLD function being active when you leave the vehicle

If the vehicle is only braked with the HOLD function it could, in the following situations, roll away:

- If there is a malfunction in the system or in the power supply.
  - If the HOLD function is deactivated by depressing the accelerator pedal or brake pedal, e.g. by a vehicle occupant.
- ▶ Always secure the vehicle against rolling away before you leave it.

#### Requirements

- The vehicle is stationary.
- The driver's door is closed or the seat belt on the driver's side is fastened.
- The vehicle has been started or has been automatically switched off by the ECO start/stop function.

- The electric parking brake is released.
- Active Distance Assist DISTRONIC is deactivated.
- The transmission is in position **D**, **R** or **N**.

#### Activating the HOLD function

- ▶ Depress the brake pedal, and after a short time quickly depress further until the **HOLD** display appears in the Instrument Display.
- ▶ Release the brake pedal.

#### Deactivating the HOLD function

- ▶ Depress the accelerator pedal to pull away. or
- ▶ Depress the brake pedal until the **HOLD** display disappears from the Instrument Display.

The HOLD function is deactivated in the following situations:

- Active Distance Assist DISTRONIC is activated.
- The transmission is shifted to position **P**.
- The vehicle is secured with the electric parking brake.

In the following situations, the vehicle is held by transmission position **P** and/or by the electric parking brake:

- The seat belt is unfastened and the driver's door is opened.
- The vehicle is switched off.
- There is a system malfunction.
- The power supply is insufficient.

#### Function of Hill Start Assist

Hill Start Assist holds the vehicle for a short time when pulling away on a hill under the following conditions:

- The transmission is in position **D** or **R**.
- The electric parking brake is released.

This gives you enough time to move your foot from the brake pedal to the accelerator pedal and depress it before the vehicle begins to roll away.

**⚠ WARNING** Risk of accident and injury due to the vehicle rolling away

After a short time, Hill Start Assist no longer holds the vehicle.

▶ Swiftly move your foot from the brake pedal to the accelerator pedal. Do not leave the vehicle when it is being held by Hill Start Assist.

## ATTENTION ASSIST

### Function of ATTENTION ASSIST

ATTENTION ASSIST assists you on long, monotonous journeys, e.g. on freeways and trunk roads. If ATTENTION ASSIST detects indicators of fatigue or increasing lapses in concentration on the part of the driver, it suggests taking a break.

ATTENTION ASSIST is only an aid. It cannot always detect fatigue or lapses in concentration in time. The system is not a substitute for a well-rested and attentive driver. On long journeys, take regular breaks in good time that allow for adequate recuperation.

You can choose between two settings:

- **Standard:** normal system sensitivity.
- **Sensitive:** higher system sensitivity. The driver is warned earlier and the attention level detected by ATTENTION ASSIST is adapted accordingly.

If drowsiness or increasing lapses in concentration are detected, the **ATTENTION ASSIST: Take a Break!** warning appears in the Instrument Display. You can acknowledge the message and take a break where necessary. If you do not take a break and ATTENTION ASSIST continues to detect increasing lapses in concentration, you will be warned again after a minimum of 15 minutes.

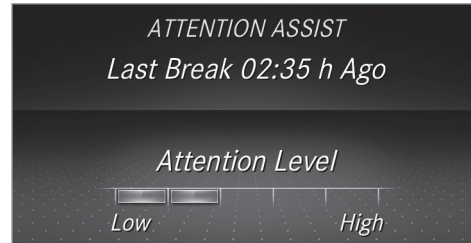

You can have the following status information for ATTENTION ASSIST displayed in the assistance menu of the on-board computer:

- The length of the journey since the last break.
- The attention level determined by ATTENTION ASSIST.

If ATTENTION ASSIST is unable to calculate the attention level and cannot issue a warning, the **System Suspended** message appears.

If a warning is output in the Instrument Display, the multimedia system offers to search for a rest area. You can select a rest area and start navigation to this rest area. This function can be activated and deactivated in the multimedia system.

If ATTENTION ASSIST is deactivated, the  symbol appears in the assistance graphic in the Instrument Display. After the vehicle is started, ATTENTION ASSIST is automatically activated. The last selected sensitivity level remains stored.

### System limits

ATTENTION ASSIST is active in the 37 mph (60 km/h) to 124 mph (200 km/h) speed range.

Particularly in the following situations, ATTENTION ASSIST functions only in a restricted manner and warnings may be delayed or not output at all:

- If you have been driving for less than approximately 30 minutes.
- If the road condition is poor (uneven road surface or potholes).
- If there is a strong side wind.
- If you adopt a sporty driving style (high cornering speeds or high rates of acceleration).
- If Active Steering Assist is activated and active (→ page 170).
- If the time has been set incorrectly.
- If you change lanes and vary your speed frequently in active driving situations.

The ATTENTION ASSIST drowsiness or alertness assessment is reset and restarted when continuing the journey in the following situations:

- If you switch off the vehicle.
- If you unfasten your seat belt and open the driver's door (e.g. to change drivers or take a break).

### Setting ATTENTION ASSIST

Multimedia system:

➔ Vehicle ➔  Assistance  
➔ ATTENTION ASSIST

#### Setting options

▶ Select **Standard**, **Sensitive** or **Off**.

#### Suggesting a rest area

- ▶ Select **Suggest Rest Area**.
- ▶ Activate  or deactivate the function .  
If ATTENTION ASSIST detects fatigue or increasing lack of attention, it suggests a rest area in the vicinity.
- ▶ **Select a suggested rest area:** you are guided to the selected rest area.

### Speed control cruise control

#### Function of cruise control

Cruise control holds the speed at the value selected by the driver.

If you accelerate to overtake, for example, the stored speed is not deleted. If you remove your



foot from the accelerator pedal after overtaking, cruise control will resume speed regulation at the stored speed.

You can set any speed from 15 mph (20 km/h) up to the maximum design speed.

Observe the notes on driving systems and your responsibility; you may otherwise fail to recognize dangers (→ page 155).

**Mercedes-AMG vehicles:** cruise control is available up to a maximum speed of 155 mph (250 km/h).

#### Displays on the instrument display

-  (gray): cruise control is selected but not activated.
-  (green): cruise control is active.

A stored speed appears alongside the  display.

-  The segments from the current stored speed to the end of the segment display light up on the speedometer.

### System limits

Cruise control may be unable to maintain the stored speed on uphill gradients. The stored speed is resumed when the gradient evens out.

Change into a lower gear in good time on long and steep downhill gradients. Take particular note of this when driving a laden vehicle. By doing so, you will make use of the engine's braking effect. This relieves the load on the brake system and prevents the brakes from overheating and wearing too quickly.

Do not use cruise control in the following situations:

- In traffic situations that require frequent changes of speed, e.g. in heavy traffic, on winding roads
- On slippery roads. Accelerating can cause the driven wheels to lose traction and the vehicle could then skid.
- When visibility is poor

### Operating cruise control

**⚠ WARNING** Risk of accident due to stored speed

If you call up the stored speed and this is lower than your current speed, the vehicle decelerates.

- ▶ Take into account the traffic situation before calling up the stored speed.

### Requirements

- ESP® is activated, but must not intervene.
- The vehicle speed is at least 15 mph (20 km/h).
- The transmission is in position **D**.

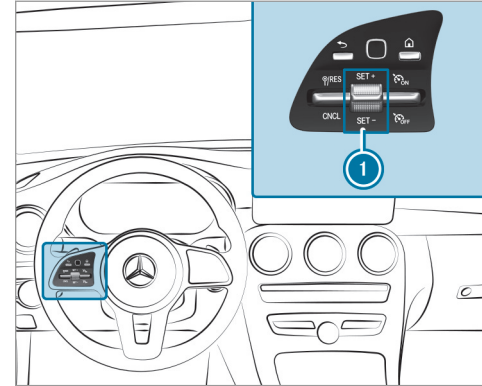

### Operating cruise control

- ▶ Press the rocker switches on the steering wheel control panel up or down to the desired position.

### Activating cruise control

- ▶ Select **ON** with the right rocker switch.

### Activating cruise control

- ▶ Press rocker  switch **SET+** up or **SET-** down.  
The current speed is stored and maintained by the vehicle.

or

- ▶ Select **RES/Ⓢ** with the left rocker switch.  
The last stored speed is called up and maintained by the vehicle.

If the last stored speed has previously been deleted, the current vehicle speed is stored.

-  When you switch off the vehicle, the last speed stored is deleted.

### Increasing or decreasing the stored speed

- ▶ 1 mph (1 km/h): press rocker switch  up **SET+** or down **SET-** to the pressure point.

or

- ▶ 5 mph (10 km/h): press rocker switch  up **SET+** or down **SET-** beyond the pressure point.

or

- ▶ Accelerate the vehicle to the desired speed and press rocker switch  up **SET+**.

### Adopting a detected speed

- ▶ Activate cruise control.
- ▶ If a traffic sign has been detected and is displayed in the instrument cluster: select **RES/Ⓢ** with the left rocker switch.  
The maximum permissible speed shown by the traffic sign is stored and the vehicle maintains or does not exceed this speed.

### Deactivating cruise control

- ▶ Select **CNCL** with the left rocker switch.

### Deactivating cruise control

- ▶ Select **OFF** with the right rocker switch.

-  If you brake, deactivate ESP® or if ESP® intervenes, cruise control is deactivated.

### Active Distance Assist DISTRONIC

**Function of Active Distance Assist DISTRONIC**  
DISTRONIC Active Distance Assist maintains the set speed while the vehicle is being driven freely. If vehicles are detected ahead, the set distance is maintained, if necessary until the vehicle comes

to a standstill. The vehicle accelerates or brakes depending on the distance to the vehicle in front and the set speed. The speed and distance to the vehicle in front are set and saved using the steering wheel.

Available speed range:

- **Vehicles without Driving Assistance Package:**  
15 mph (20 km/h) – 120 mph (200 km/h)
- **Vehicles with Driving Assistance Package:**  
15 mph (20 km/h) – 130 mph (210 km/h)

Other features of Active Distance Assist DISTRONIC:

- Adjusts the driving style depending on the selected drive program (fuel-saving, comfortable or dynamic)
- Initiates acceleration to the stored speed if the turn signal indicator is switched on to change to the overtaking lane
- **Vehicles with Driving Assistance Package:**
  - Reacts to stationary vehicles detected in urban speed ranges (except bicycles and motorcycles)

- Takes one-sided overtaking restrictions into account on freeways or on multi-lane roads with separate roads (country-dependent)

**Vehicles with Driving Assistance Package and Parking Package:** if the vehicle has been braked to a standstill on multi-lane, separate roads by Active Distance Assist DISTRONIC, it can automatically follow the vehicle in front when it drives off again within 30 seconds. If a critical situation is detected when you are driving off, a visual and acoustic warning is output indicating that the driver must now take control of the vehicle. The vehicle is not accelerated any further.

Observe the notes on driving systems and your responsibility; you may otherwise fail to recognize dangers (→ page 155).

### Active Distance Assist DISTRONIC displays in the Instrument Display

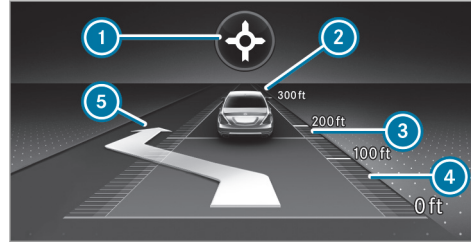

Assistance graphic

- 1 Route-based speed adaptation: type of route event (→ page 169)
- 2 Vehicle in front
- 3 Distance indicator
- 4 Set specified distance
- 5 Active Lane Change Assist lane change display

### Permanent status display of Active Distance Assist DISTRONIC

- (white): Active Distance Assist DISTRONIC selected, specified distance set
- (white vehicle, green speedometer): Active Distance Assist DISTRONIC active, specified distance set and vehicle detected
- (green): Active Distance Assist DISTRONIC active, specified distance set and vehicle detected
- : Route-based speed adaptation active (→ page 169).

The stored speed is shown along with the permanent status display and highlighted on the speedometer. When Active Distance Assist DISTRONIC is passive, the speed is grayed out.

- i On freeways or high-speed major roads, the green vehicle symbol is displayed cyclically when the vehicle is ready to pull away.

- ❗ If you depress the accelerator pedal beyond the setting of the Active Distance Assist DISTRONIC, the system is switched to passive mode. The  **Suspended** message appears in the instrument display.

### Display on the speedometer

The stored speed is highlighted on the speedometer. If the speed of the vehicle in front or the speed adjustment for the route event ahead is less than the stored speed, the segments in the speedometer light up. The Instrument Display shows the deactivation of Active Distance Assist DISTRONIC and alterations to the speed due to manual or automatic adoption of the maximum permissible speed.

### System limits

The system may be impaired or may not function in the following situations, for example:

- In snow, rain, fog, heavy spray, if there is glare, in direct sunlight or in greatly varying ambient light.
- The windshield in the area of the camera is dirty, fogged up, damaged or covered.
- If the radar sensors are dirty or covered.
- In parking garages or on roads with steep uphill or downhill gradients.
- If there are narrow vehicles in front, such as bicycles or motorcycles.

In addition, on slippery roads, braking or accelerating can cause one or several wheels to lose traction and the vehicle could then skid.

Do not use Active Distance Assist DISTRONIC in these situations.

### **WARNING** Risk of accident from acceleration or braking by Active Distance Assist DISTRONIC

Active Distance Assist DISTRONIC may accelerate or brake in the following cases, for example:

- If the vehicle pulls away using Active Distance Assist DISTRONIC.
- If the stored speed is called up and is considerably faster or slower than the currently driven speed.

- If Active Distance Assist DISTRONIC no longer detects a vehicle in front or does not react to relevant objects.

- ▶ Always carefully observe the traffic conditions and be ready to brake at all times.
- ▶ Take into account the traffic situation before calling up the stored speed.

### **WARNING** Risk of accident due to insufficient deceleration by Active Distance Assist DISTRONIC

Active Distance Assist DISTRONIC brakes your vehicle with up to 50% of the possible deceleration. If this deceleration is not sufficient, Active Distance Assist DISTRONIC alerts you with a visual and acoustic warning.

- ▶ Adjust your speed and maintain a suitable distance from the vehicle in front.
- ▶ Brake the vehicle yourself and/or take evasive action.



**⚠ WARNING** Risk of accident if detection function of Active Distance Assist DISTRONIC is impaired

Active Distance Assist DISTRONIC does not react or has a limited reaction:

- when driving on a different lane or when changing lanes
- to pedestrians, animals, bicycles or stationary vehicles, or unexpected obstacles
- to complex traffic conditions
- to oncoming vehicles and crossing traffic

As a result, Active Distance Assist DISTRONIC may neither give warnings nor intervene in such situations.

▶ Always observe the traffic conditions carefully and react accordingly.

### Operating Active Distance Assist DISTRONIC

#### Requirements

- The electric parking brake is released.
- ESP® is activated, but must not intervene.

- The transmission is in position **D**.
- The driver's door is closed.
- Check of the radar sensor system has been successfully completed.
- Parking Assist PARKTRONIC is not being used to park the vehicle or to exit from a parking space.

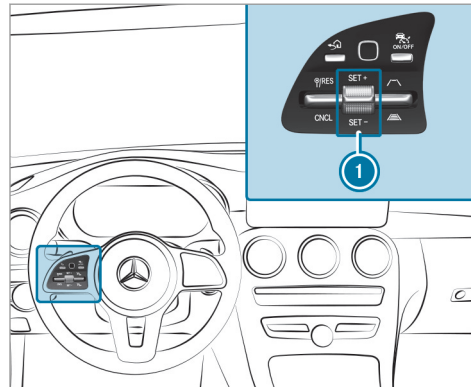

▶ **To operate Active Distance Assist DISTRONIC:** press the rocker switches on the steering wheel control unit up or down to the desired position.

#### Activating/deactivating Active Distance Assist DISTRONIC

▶ Press button .

#### Activating Active Distance Assist DISTRONIC

▶ **To activate without a stored speed:** press rocker switch **1** up **SET+** or down **SET-**, or select **RES** with the left rocker switch.

or

- ▶ **To activate with a stored speed:** select **RES** with the left rocker switch.
- ▶ Remove your foot from the accelerator pedal. The current speed is stored and maintained by the vehicle.

#### Adopting a detected speed limit

▶ Activate Active Distance Assist DISTRONIC.

- ▶ If a traffic sign has been detected and is displayed in the instrument cluster: select  with the left rocker switch. The maximum permissible speed on the traffic sign is adopted as the stored speed. The vehicle adapts its speed to that of the vehicle in front, but only up to the stored speed.

#### Pulling away with Active Distance Assist DISTRONIC

- ▶ Activate Active Distance Assist DISTRONIC and remove your foot from the brake pedal.
- ▶ Select  with the left rocker switch.

or

- ▶ Depress the accelerator pedal briefly and firmly. The functions of Active Distance Assist DISTRONIC continue to be carried out.

#### Deactivating Active Distance Assist DISTRONIC

**⚠ WARNING** Risk of an accident due to Active Distance Assist DISTRONIC being active when you leave the driver's seat



If you leave the driver's seat while the vehicle is being braked by Active Distance Assist DISTRONIC only, the vehicle can roll away.

- ▶ Always deactivate Active Distance Assist DISTRONIC and secure the vehicle to prevent it from rolling away before you leave the driver's seat.



- ▶ Select  with the left rocker switch.

- ▶  If you brake, deactivate ESP® or if ESP® intervenes, Active Distance Assist DISTRONIC is deactivated.



#### Increasing or decreasing the speed

- ▶ 1 mph (1 km/h): press rocker switch  up  or down  to the pressure point.



or

- ▶ 5 mph (10 km/h): press rocker switch  up  or down  beyond the pressure point.

or

- ▶ Accelerate the vehicle to the desired speed and press rocker switch  up .

#### Changing the specified distance to the vehicle in front

- ▶ **To reduce the specified distance:** press the right rocker switch up (.
- ▶ **To increase the specified distance:** press the right rocker switch down (.

#### Function of Active Speed Limit Assist

If a change in the speed limit of 12 mph (20 km/h) or more is detected and automatic adoption of speed limits is activated, the new speed limit is automatically adopted as the stored speed (→ page 181).

The driven speed is adjusted when the vehicle is level with the traffic sign at the latest. In the case of signs indicating entry into an urban area, the speed is adapted according to the speed permitted within the urban area. The speed limit display in the Instrument Display is always updated when the vehicle is level with the traffic sign.

If there is no speed restriction on an unlimited stretch of road (e.g. on a freeway), the recommended speed is automatically adopted as the stored speed. The system uses the speed stored on an unlimited stretch of road as the recommended speed. If you do not alter the stored speed on an unlimited stretch of road, the recommended speed is 80 mph (130 km/h).

If Active Distance Assist DISTRONIC has been put into passive mode by pressing the accelerator pedal, only speed limits that are higher than the set speed are adopted.

Observe the notes on driving systems and your responsibility; you may otherwise fail to recognize dangers (→ page 155).

### System limits

The system limits of Traffic Sign Assist apply to the detection of traffic signs (→ page 180).

Speed limits below 12 mph (20 km/h) are not automatically adopted by the system as the stored speed. Temporary speed restrictions (e.g. for a certain time or due to weather conditions) cannot be properly detected by the system. The maxi-

mum permissible speed applying to a vehicle with a trailer is not detected by the system.

Adjust the speed in these situations.

**⚠ WARNING** Risk of accident due to Active Speed Limit Assist adapting the vehicle's speed

The speed adopted by Active Speed Limit Assist may be too high or incorrect in some individual cases, such as:

- at speed limits below 12 mph (20 km/h)
- in wet conditions or in fog
- when towing a trailer
- ▶ Ensure that the driven speed complies with traffic regulations.
- ▶ Adjust the driving speed to suit current traffic and weather conditions.

### Function of route-based speed adaptation

When Active Distance Assist DISTRONIC is activated, the vehicle speed will be adapted accordingly to the route events ahead. Depending on the drive program selected, the vehicle negotiates a route

event ahead in an economical, comfortable or dynamic manner. When the route event has been passed, the vehicle accelerates again to the stored speed. The set distance to the vehicle in front, vehicles detected ahead and speed restrictions ahead are taken into account.

You can activate and deactivate route-based speed adaptation in the multimedia system (→ page 170).

The following route events are taken into account:

- Bends
- T-intersections, traffic circles and toll stations
- Turns and exits
- Traffic jams ahead (only with Live Traffic Information (→ page 263))
- ⓘ When the toll station is reached, Active Distance Assist DISTRONIC adopts the speed as the stored speed.

Also, the speed is reduced if the turn signal indicator to change lanes is switched on and one of the following situations is detected:

- Turning at intersections

## 170 Driving and parking

- Driving on slowing-down lanes
- Driving on lanes adjacent to slowing-down lanes

The driver is responsible for choosing the right speed and observing other road users. This applies in particular to intersections, traffic circles and traffic lights because route-based speed adaptation does not brake the vehicle to a standstill.

When route guidance is active, the first speed adjustment is carried out automatically. If the turn signal indicator is switched on, the selected route is confirmed and further speed adjustment is activated.

Speed adaptation is canceled in the following cases:

- If the turn signal indicator is switched off before the route event.
- If the driver depresses the accelerator or brake pedal during the process.

### System limits

Route-based speed adaptation does not take right of way regulations into account. The driver is

responsible for complying with road traffic regulations and driving at a suitable speed.

The speed adaptation made by the system may not always be suitable, particularly in the following situations:

- The course of the road is not clearly visible
- Road narrowing
- Varying maximum permissible speeds in individual lanes, for example at toll stations
- Wet road surfaces, snow or ice

In these situations, the driver must intervene accordingly.

### **WARNING** Risk of accident in spite of route-based speed adaptation

Route-based speed adaptation can malfunction or be temporarily unavailable in the following situations:

- If the driver does not follow the calculated route
- If map data is not up-to-date or available

- In the event of roadworks
- In bad weather or road conditions
- If the accelerator pedal is depressed
- In the event of electronically displayed speed limitations

▶ Adapt the speed to the traffic situation.

### Setting route-based speed adjustment

#### Requirements:

- Active Distance Assist DISTRONIC is activated.

Multimedia system:

 [Vehicle](#)  [Assistance](#)  
 [Speed Adjustment](#)

 Activate  or deactivate  the function.

### Active Steering Assist

#### Function of Active Steering Assist

Active Steering Assist is available only up to a speed of 130 mph (210 km/h). The system helps you to stay in the center of the lane by means of

moderate steering interventions. Depending on the speed driven, Active Steering Assist uses the vehicles ahead and lane markings as a reference.

- i Depending on the country, and in the lower speed range, Active Steering Assist can use the surrounding traffic as a reference. If necessary, Active Steering Assist can also provide assistance when the vehicle is driven away from the center of the lane, for example, to form a rescue lane.

If the detection of lane markings and vehicles ahead is impaired, Active Steering Assist switches to passive mode. The system provides no support in this case.

#### Status display of Active Steering Assist in the Instrument Display

- 👁️ (gray): activated and passive
  - 👁️ (green): activated and active
  - 👁️ (red): system limits detected
  - 👁️ (white, red hands): "hands on the steering wheel" prompt
- i During the transition from active to passive status, the 👁️ symbol is shown as enlarged

and flashing. Once the system is passive, the 👁️ symbol is shown as gray in the Instrument Display.

- i Depending on the selected vehicle settings, Active Steering Assist may be unavailable.

#### Steering and touch detection

The driver is required to keep their hands on the steering wheel at all times and be able to intervene at any time to correct the course of the vehicle and keep it in lane. The driver must expect a change from active to passive mode or vice versa at any time.

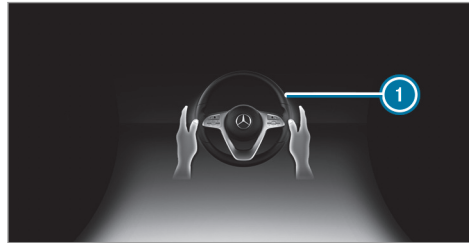

If the system detects that the driver has not steered the vehicle for a considerable period of

time or has removed their hands from the steering wheel, display 1 appears. If the driver still does not steer the vehicle, a warning tone sounds in addition to the visual warning message.

If the driver does not react to the warning for a considerable period, the system can initiate an emergency stop (→ page 173).

The warning is not issued or is stopped when the driver gives confirmation to the system:

- The driver steers the vehicle.
- Depending on the country:** the driver presses a steering wheel button or operates Touch Control

If Active Steering Assist detects that a system limit has been reached, a visual warning is issued and a warning tone sounds.

Observe the notes on driving systems and your responsibility; you may otherwise fail to recognize dangers (→ page 155).

#### System limits

Active Steering Assist has a limited steering torque for lateral guidance. In some cases, the steer-

ing intervention is not sufficient to keep the vehicle in the lane or to drive through exits.

The system may be impaired or may not function in the following instances:

- There is poor visibility, e.g. due to snow, rain, fog, heavy spray, greatly varying ambient light or strong shadows on the road.
- There is glare, e.g. from oncoming traffic, direct sunlight or reflections.
- Insufficient road illumination.
- The windshield is dirty, fogged up, damaged or covered in the vicinity of the camera, e.g. by a sticker.
- No, or several, unclear lane markings are present for one lane, or the markings change quickly, for example, in a construction area or intersections.
- The lane markings are worn away, dark or covered up, e.g. by dirt or snow.
- If the distance to the vehicle in front is too short and thus the lane markings cannot be detected.
- The road is narrow and winding.

- There are obstacles on the lane or projecting out into the lane, such as object markers.

The system does not provide assistance in the following conditions:

- On tight bends and when turning.
- When crossing intersections.
- At traffic circles or toll stations.
- When the tire pressure is too low.

**⚠ WARNING** Risk of accident if Active Steering Assist unexpectedly stops functioning

If the system limits of Active Steering Assist are reached there is no guarantee that the system will remain active or will keep the vehicle in lane.

- ▶ Always keep your hands on the steering wheel and observe the traffic carefully.
- ▶ Always steer the vehicle paying attention to traffic conditions.

**⚠ WARNING** Risk of accident if Active Steering Assist unexpectedly intervenes

The detection of lane markings and objects may malfunction and cause unexpected steering interventions.

- ▶ Steer according to traffic conditions.

**Activating Active Steering Assist**

**Requirements:**

- ESP<sup>®</sup> must be activated, but not intervening.
- Active Distance Assist DISTRONIC is activated.

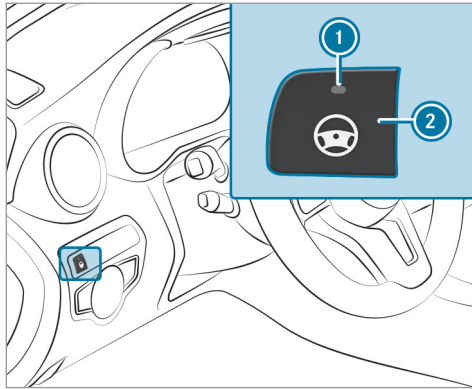

► If indicator lamp ❶ is off: press button ❷.

### Function of Active Emergency Stop Assist



If the system detects that the driver has not steered the vehicle for a considerable period of time or has removed their hands from the steering wheel, display ❶ appears in the Instrument Display. If the driver still does not steer the vehicle or gives no confirmation to the system, a warning tone sounds in addition to the visual warning message.

If the driver still does not respond to the warning, the **Beginning Emergency Stop** message appears in the Instrument Display. If the driver still does not respond, Active Distance Assist DISTRONIC

reduces the speed. The vehicle is decelerated in stages to a standstill.

Depending on the country, and at speeds below 40 mph (60 km/h), the hazard warning lights switch on automatically.

When the vehicle is stationary, the following actions are performed:

- The vehicle is secured with the electric parking brake.
- Active Distance Assist DISTRONIC is ended.
- The vehicle is unlocked.
- If possible, an emergency call is placed to the Mercedes-Benz emergency call center.

The driver can cancel the deceleration at any time by performing one of the following actions:

- Steering
- Braking or accelerating
- Deactivating Active Distance Assist DISTRONIC

## Active Lane Change Assist

### Function of Active Lane Change Assist



Active Lane Change Assist supports the driver during lane changes by applying steering torque if the driver activates a turn signal indicator.

Observe the notes on driving systems and your responsibility; you may otherwise fail to recognize dangers (→ page 155).

Assistance during lane changes is provided if all the following conditions are met:

- You are driving on a freeway or road with multiple lanes in the direction of travel.
- The neighboring lane is separated by a broken lane marking.
- No vehicle is detected in the adjacent lane.
- The vehicle speed is between 50 mph (80 km/h) and 110 mph (180 km/h).
- Active Lane Change Assist is switched on in the multimedia system.
- Active Steering Assist is activated and active.

If no vehicle is detected in the adjacent lane and a lane change is permitted, the lane change begins

after the driver has activated the turn signal indicator. This is shown to the driver with a green arrow next to the  steering wheel symbol. The message, for example, also appears. If Active Lane Change Assist has been activated with the turn signal indicator but a lane change is not immediately possible, a gray arrow appears next to the  steering wheel symbol, which remains green.

When lane change assistance starts, the turn signal indicator is automatically activated along with the display in the Instrument Display.

If the assistance graphic is shown during lane changes, an additional arrow appears in it pointing towards the adjacent lane (→ page 164).

If a lane change is not possible, the arrow is faded out after a few seconds and a new lane change must be initiated. An immediate lane change is possible only on freeway sections without speed limits.

If the system is impaired, Active Lane Change Assist may be canceled. If it is canceled, the message appears in the Instrument Display.

In addition, a warning tone may sound, depending on the situation.

### **WARNING** Risk of accident when changing lane to an occupied adjacent lane

Lane Change Assist cannot always clearly detect if the adjacent lane is free.

The lane change might be initiated although the adjacent lane is not free.

- ▶ Before changing lanes, make sure that the neighboring lane is free and there is no danger to other road users.
- ▶ Monitor the lane change.

### **WARNING** Risk of accident if Lane Change Assist unexpectedly stops functioning

If the system limitations for Lane Change Assist have been reached, there is no guarantee that the system will remain active.

Lane Change Assist cannot then assist you by applying steering torque.

- ▶ Always monitor the lane change and keep your hands on the steering wheel.



Observe the traffic conditions and steer and/or brake if necessary.

### System limits

The system limitations of Active Steering Assist apply to Active Lane Change Assist (→ page 170).

The system may also be impaired or may not function in the following situations:

- The sensors in the rear bumper are dirty, damaged or covered by a sticker or ice and snow, foreexample.
  - The exterior lighting shows a defect.
- i** The Active Lane Change Assist sensors adjust automatically while a certain distance is being driven after the vehicle has been delivered. Active Lane Change Assist is unavailable or available only partially during this teach-in process; no arrow appears next to the  Active Steering Assist symbol when the turn signal indicator is activated.

### Activating/deactivating Active Lane Change Assist

Multimedia system:

→ **Vehicle** ▶  **Assistance**

- ▶ Select **Lane Change Assist**.
- ▶ Activate  or deactivate  the function.

### Active Brake Assist

#### Function of Active Brake Assist

Active Brake Assist consists of the following functions:

- Distance warning function
- Autonomous braking function
- Situation-dependent braking assistance
- **Vehicles with Driving Assistance Package:** Evasive Steering Assist and turning maneuver function

Active Brake Assist can help you to minimize the risk of a collision with vehicles, cyclists or pedestrians or to reduce the effects of such a collision.

If Active Brake Assist has detected a risk of collision, a warning tone will sound and the distance warning lamp  will light up on the instrument cluster.

If you do not react to the warning, autonomous braking can be initiated in critical situations.

In especially critical situations, Active Brake Assist can initiate autonomous braking directly. In this case, the warning lamp and warning tone will occur simultaneously with the braking application.

If you apply the brake yourself in a critical situation or apply the brake during autonomous braking, situation-dependent braking assistance will occur. The brake pressure will increase up to maximum full-stop braking if necessary.

Observe the notes on driving systems and your responsibility; you may otherwise fail to recognize dangers (→ page 155).

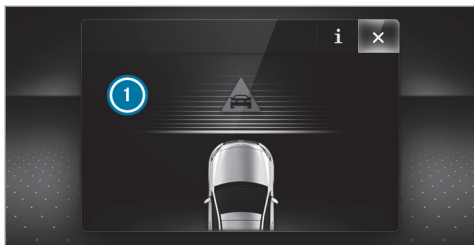

If autonomous braking or situation-dependent braking assistance has occurred, display ① will appear on the instrument display and then automatically go out after a short time.

**⚠ WARNING** Risk of an accident caused by limited detection performance of Active Brake Assist

Active Brake Assist cannot always clearly identify objects and complex traffic situations.

In such cases, Active Brake Assist might:

- Give a warning or brake without reason
- Not give a warning or not brake

Active Brake Assist is only an aid. The driver is responsible for maintaining a sufficiently safe distance to the vehicle in front, vehicle speed and for braking in good time.

- ▶ Always pay careful attention to the traffic situation; do not rely on Active Brake Assist alone.
- ▶ Be prepared to brake or swerve if necessary.

If Active Brake Assist is deactivated or the functions are restricted, e.g. due to activation of another driving system, the  display message will appear on the driver's display.

If the system is unavailable due to dirty or damaged sensors or due to a malfunction, or if the functions are restricted, the  warning lamp will appear on the driver's display.

Also observe the system limits of Active Brake Assist.

### The individual subfunctions are available in various speed ranges:

The distance warning function can issue a warning in the following situations:

- From approximately 4 mph (7 km/h), if your vehicle is critically close to a vehicle, cyclist or pedestrian, you will hear an intermittent warning tone and the distance warning lamp  will light up on the instrument cluster.

Brake immediately or take evasive action, provided it is safe to do so and the traffic situation allows this.

### Distance warning function (vehicles without Driving Assistance Package)

The distance warning function can aid you in the following situations with an intermittent warning tone and a warning lamp:

- at speeds up to approximately 155 mph (250 km/h) when approaching vehicles ahead
- at speeds up to approximately 50 mph (80 km/h) when approaching stationary vehicles, moving pedestrians, and cyclists ahead

- at speeds up to approximately 37 mph (60 km/h) when approaching crossing cyclists

#### **Distance warning function (vehicles with Driving Assistance Package)**

The distance warning function can aid you in the following situations with an intermittent warning tone and a warning lamp:

- at speeds up to approximately 155 mph (250 km/h) when approaching vehicles ahead
- at speeds up to approximately 62 mph (100 km/h) when approaching stationary vehicles
- at speeds up to approximately 50 mph (80 km/h) when approaching moving pedestrians and cyclists ahead
- at speeds up to approximately 43 mph (70 km/h) when approaching stationary pedestrians, crossing vehicles and stationary and crossing cyclists

#### **Autonomous braking function (vehicles without Driving Assistance Package)**

From a speed of approximately 4 mph (7 km/h), the autonomous braking function may intervene in the following situations:

- at speeds up to approximately 124 mph (200 km/h) when approaching vehicles ahead
- at speeds up to approximately 50 mph (80 km/h) when approaching cyclists ahead
- at speeds up to approximately 37 mph (60 km/h) when approaching moving pedestrians and crossing cyclists
- at speeds up to approximately 31 mph (50 km/h) when approaching stationary vehicles

#### **Autonomous braking function (vehicles with Driving Assistance Package)**

From a speed of approximately 4 mph (7 km/h), the autonomous braking function may intervene in the following situations:

- at speeds up to approximately 155 mph (250 km/h) when approaching vehicles ahead

- at speeds up to approximately 62 mph (100 km/h) when approaching stationary vehicles
- at speeds up to approximately 50 mph (80 km/h) when approaching cyclists ahead
- at speeds up to approximately 43 mph (70 km/h) when approaching stationary and moving pedestrians, crossing vehicles and stationary and crossing cyclists

#### **Situation-dependent braking assistance (vehicles without Driving Assistance Package)**

The situation-dependent braking assistance can intervene from a speed of approximately 4 mph (7 km/h) in the following situations:

- at speeds up to approximately 155 mph (250 km/h) when approaching vehicles ahead
- at speeds up to approximately 50 mph (80 km/h) when approaching stationary vehicles and cyclists ahead
- at speeds up to approximately 37 mph (60 km/h) when approaching moving pedestrians and crossing cyclists

### **Situation-dependent braking assistance (vehicles with Driving Assistance Package)**

The situation-dependent braking assistance can intervene from a speed of approximately 4 mph (7 km/h) in the following situations:

- at speeds up to approximately 155 mph (250 km/h) when approaching vehicles ahead
- at speeds up to approximately 62 mph (100 km/h) when approaching stationary vehicles
- at speeds up to approximately 50 mph (80 km/h) when approaching cyclists ahead
- at speeds up to approximately 37 mph (60 km/h) when approaching stationary and moving pedestrians, crossing vehicles, and stationary and crossing cyclists

### **Canceling a brake application of Active Brake Assist**

You can cancel a brake application of Active Brake Assist at any time by:

- sharply depressing the accelerator pedal or with kickdown
- releasing the brake pedal

Active Brake Assist may cancel the brake application when one of the following conditions is fulfilled:

- You maneuver to avoid the obstacle.
- There is no longer a risk of collision.
- An obstacle is no longer detected in front of your vehicle.

### **Evasive Steering Assist (only vehicles with Driving Assistance Package)**

Evasive Steering Assist has the following characteristics:

- The ability to detect stationary or moving pedestrians.
- Assistance through power-assisted steering if a swerving maneuver is detected.
- Activation due to an abrupt steering movement in the event of a swerving maneuver.
- Assistance during swerving and straightening of the vehicle.
- Reaction from a speed of approximately 12 mph (20 km/h) up to a speed of approximately 43 mph (70 km/h).

You can cancel the assistance at any time by actively steering.

### **Turning maneuver function (only vehicles with Driving Assistance Package)**

If the system detects a risk of a collision with an oncoming vehicle when turning across an oncoming lane, autonomous braking can be initiated at speeds below 9 mph (15 km/h) before you have left the lane in which you are driving.

#### **⚠ WARNING Risk of accident despite Evasive Steering Assist**

Evasive Steering Assist cannot always recognize objects or complex traffic situations clearly.

Moreover, the steering support provided by Evasive Steering Assist is not sufficient to avoid a collision.

- ▶ Always pay careful attention to the traffic situation; do not rely on Evasive Steering Assist alone.
- ▶ Be prepared to brake or swerve if necessary.

- ▶ End the support by actively steering in non-critical situations.
- ▶ Drive at an appropriate speed if there are pedestrians close to the path of your vehicle.

### System limits

Full system performance is not yet available for a few seconds after switching on the vehicle or after driving off.

The system may be impaired or may not function, particularly in the following situations:

- In snow, rain, fog, heavy spray, direct sunlight or variable light conditions or if there is glare.
- If the sensors are dirty, fogged up, damaged or covered.
- If the sensors are impaired due to interference from other radar sources, e.g. strong radar reflections in parking garages.
- If a loss of tire pressure or a defective tire has been detected and displayed.
- In complex traffic situations where objects cannot always be clearly identified.

- If pedestrians or vehicles move quickly into the sensor detection range.
  - If pedestrians are hidden by other objects.
  - If the typical outline of a pedestrian cannot be distinguished from the background.
  - If a pedestrian is not detected as such, e.g. due to special clothing or other objects.
  - If the driver's seat belt is not fastened.
  - On bends with a tight radius.
- ❶ The Active Brake Assist sensors adjust automatically while a certain distance is being driven after the vehicle has been delivered. Active Brake Assist is unavailable or only partially available during the teach-in process.

### Setting Active Brake Assist

Multimedia system:

➔ Vehicle ➔  Assistance  
 ➔ Active Brake Assist

The settings can be adjusted when the ignition is switched on.

▶ Select **Early**, **Medium** or **Late**.

- ❶ Your selection will be retained when the vehicle is next started.

### Deactivating Active Brake Assist

- ❶ It is recommended that you always leave Active Brake Assist activated.

▶ Select **Off**.

The distance warning function and the autonomous braking function will be deactivated.

**Vehicles without Driving Assistance Package:** when the vehicle is next started, the medium setting will automatically be selected.

**Vehicles with Driving Assistance Package:** Evasive Steering Assist will not be available. When the ignition is next started, the medium setting will be selected automatically and Evasive Steering Assist will be available.

- ❶ If Active Brake Assist is deactivated, the  symbol appears in the status bar of the multi-function display.

## Traffic Sign Assist

### Function of Traffic Sign Assist

Traffic Sign Assist detects traffic signs with the multifunction camera (→ page 155). It assists you by displaying detected speed limits and overtaking restrictions in the Instrument Display.

Observe the notes on driving systems and your responsibility; you may otherwise fail to recognize dangers (→ page 155).

Since Traffic Sign Assist also uses the data stored in the navigation system, it can update the display in the following situations without detecting traffic signs.

The camera also detects traffic signs with a restriction indicated by an additional sign (e.g. when wet). These are displayed only if a restriction applies or if the system cannot clearly determine whether the restriction applies.

### Warning when the maximum permissible speed is exceeded

The system can warn you if you unintentionally exceed the maximum permissible speed. To do this, you can specify in the multimedia system by how much the maximum permissible speed can

be exceeded before a warning is issued. You can specify whether the warning is to be just a visual warning or an acoustic one as well.

### Display in the Instrument Display

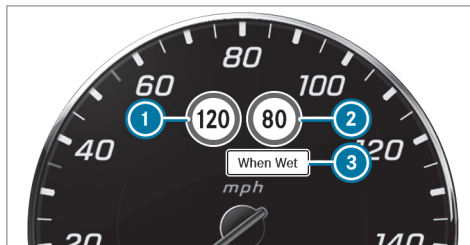

Instrument display in the widescreen cockpit

- ① Maximum permissible speed
  - ② Maximum permissible speed when a restriction applies
  - ③ Additional sign with restriction
- ⓘ **Vehicles with a standard Instrument Display:** a + symbol next to a traffic sign in the Instrument Display indicates that additional traffic signs have been detected. These can also be

displayed in the media display and optionally in the head-up display.

If Traffic Sign Assist cannot determine the maximum permissible speed (e.g. due to missing signs), the following display appears in the Instrument Display:



This is displayed continuously if the vehicle is in a country where Traffic Sign Assist is not supported. Traffic Sign Assist is not available in all countries.

- ⓘ Also observe the information on display messages in Traffic Sign Assist (→ page 400).

### System limits

The system may be impaired or may not function particularly in the following situations:

- If there is poor visibility, e.g. due to insufficient illumination of the road, highly variable shade conditions, rain, snow, fog or heavy spray.
- If there is glare, e.g. from oncoming traffic, direct sunlight or reflections.

- If there is dirt on the windshield in the vicinity of the multifunction camera or if the camera is fogged up, damaged or obscured.
- If the traffic signs are hard to detect, e.g. due to dirt, snow or insufficient lighting, or because they are covered.
- If the information in the navigation system's digital map is incorrect or out of date.
- If signs are ambiguous, e.g. road signs in road-works or in adjacent lanes.
- If you turn sharply when passing traffic signs outside the camera's field of vision.

### Setting Traffic Sign Assist

#### Requirements:

- **For automatic adoption of speed limits:** Active Distance Assist DISTRONIC is activated.

Multimedia system:

- Vehicle →  Assistance
- Traffic Sign Assist

### Activating or deactivating automatic adoption of speed limits

- ▶ Select **Limit Adoption**.
- ▶ Activate  or deactivate  the function. The speed limits detected by Traffic Sign Assist are automatically adopted by Active Distance Assist DISTRONIC.

### Displaying detected traffic signs in the media display

- ▶ Select **Display in COMAND**.
- ▶ Activate  or deactivate  the function.
- ⓘ If one of the following systems is activated, the detected speed can be manually adopted as the speed limit:
  - Active Distance Assist DISTRONIC
  - Cruise control

Further information (→ page 167).

### Adjusting the type of warning

- ▶ Select **Visual & Audible**, **Visual** or **None**.

### Adjusting the warning threshold

This value determines the speed at which a warning is issued when exceeded.

- ▶ Select **Warning Threshold**.
- ▶ Set the desired speed.



### Blind Spot Assist and Active Blind Spot Assist with exit warning

#### Function of Blind Spot Assist and Active Blind Spot Assist with exit warning

Blind Spot Assist and Active Blind Spot Assist use two lateral, rear-facing radar sensors to monitor the area up to 130 ft (40 m) behind and 10 ft (3 m) next to your vehicle.

If a vehicle is detected at speeds above approximately 8 mph (12 km/h) and this vehicle subsequently enters the monitoring range directly next to your vehicle, the warning lamp in the outside mirror will light up red.

Permanent status display on the instrument cluster:

-  (gray): system is activated but not operational
-  (green): system is activated and operational

If a vehicle is detected close to your vehicle and you switch on the turn signal indicator in the corresponding direction, a double warning tone will sound and the red warning lamp in the outside mirror will flash. If the turn signal indicator remains switched on, all other detected vehicles will be indicated only by the flashing of the red warning lamp.

If you overtake a vehicle quickly, no warning is given.

**⚠ WARNING** Risk of accident despite Active Blind Spot Assist

Active Blind Spot Assist does not react to the following:

- if you overtake a vehicle too closely so that it is in the blind spot area
- if vehicles traveling at a much faster speed approach and then overtake

Active Blind Spot Assist may not give warnings or intervene in such situations.

- ▶ Always pay careful attention to the traffic situation and maintain a safe distance at the side of the vehicle.

Observe the notes on driving systems and your responsibility; you may otherwise fail to recognize dangers (→ page 155).

**Exit warning**

The exit warning is an additional function of Blind Spot Assist and can warn vehicle occupants about approaching vehicles when leaving a stationary vehicle.

**⚠ WARNING** Risk of accident despite exit warning

The exit warning neither reacts to stationary objects nor to persons or road users approaching you at a greatly differing speed. The exit warning cannot warn drivers in these situations.

- ▶ Always pay particular attention to the traffic situation when opening the doors and make sure there is sufficient clearance.

If there is a vehicle in the monitoring range, this will be indicated in the outside mirror. If a vehicle occupant opens the door on the side with the warning, a warning tone will sound and the warning lamp in the outside mirror will start to flash.

This additional function is only available when Blind Spot Assist is active. When the exit warning is activated, it can warn vehicle occupants for up to three minutes after the vehicle is switched off. The exit warning is no longer available once the warning lamp in the outside mirror flashes three times.



The exit warning is only an aid and is not a substitute for the attention of vehicle occupants. The responsibility when opening the doors and leaving the vehicle remains with the vehicle occupants.

### System limits

Blind Spot Assist and Active Blind Spot Assist may be limited in the following situations, in particular:

- if there is dirt on the sensors or the sensors are obscured
- in poor visibility, e.g. due to fog, heavy rain or snow
- if there are narrow vehicles, e.g. bicycles or motorbikes
- if the road has very wide or narrow lanes
- if vehicles are not driving in the middle of their lane

Warnings may be issued in error when you drive close to crash barriers or similar solid boundaries. Always make sure that there is sufficient lateral distance for other road users or obstacles.

Warnings may be interrupted when driving alongside long vehicles, for example trucks, for a prolonged period of time.

Blind Spot Assist is not operational when reverse gear is engaged.

The exit warning may be limited in the following situations:

- when the sensors are covered by adjacent vehicles in narrow parking spaces
- when people approach the vehicle
- in the event of stationary or slowly moving objects

### Function of brake application (Active Blind Spot Assist)

If Active Blind Spot Assist detects a risk of a side impact in the monitoring range, a course-correcting brake application will be carried out. This is designed to help you avoid a collision.

The course-correcting brake application is available in the speed range between approximately 20 mph (30 km/h) and 125 mph (200 km/h).

### **⚠ WARNING** Risk of accident despite brake application of Active Blind Spot Assist

A course-correcting brake application cannot always prevent a collision.

- ▶ Always steer, brake or accelerate yourself, especially if Active Blind Spot Assist warns you or makes a course-correcting brake application.
- ▶ Always maintain a safe distance at the sides.



If a course-correcting brake application occurs, the red warning lamp will flash in the outside mirror and a warning tone will sound. In addition, dis-

play **1** indicating the danger of a side collision will appear on the instrument display.

In rare cases, the system may make an inappropriate brake application. This brake application may be interrupted at any time by steering slightly in the opposite direction or accelerating.

### System limits

Also note the system limitations of Active Blind Spot Assist; you may otherwise fail to recognize dangers (→ page 181).

Either a course-correcting brake application appropriate to the driving situation, or none at all, will occur in the following situations:

- Vehicles or obstacles, e.g. crash barriers, are located on both sides of your vehicle.
- An oncoming vehicle passes with little lateral clearance.
- You have adopted a sporty driving style with high cornering speeds.
- You brake or accelerate significantly.
- A driving safety system intervenes, e.g. ESP® or Active Brake Assist.

- ESP® is deactivated.
- A loss of tire pressure or a defective tire is detected.

### Activating/deactivating Blind Spot Assist or Active Blind Spot Assist

Multimedia system:

→ Vehicle →  Assistance

→ Blind Spot Assist

▶ Activate  or deactivate  the function.

### Active Lane Keeping Assist

#### Function of Active Lane Keeping Assist

Active Lane Keeping Assist monitors the area in front of your vehicle by means of a multifunction camera (→ page 155). It serves to protect you against unintentionally leaving your lane. You will be warned by vibration pulses in the steering wheel and guided back into your lane by a course-correcting brake application.

Active Lane Keeping Assist is available in the speed range between 37 mph (60 km/h) and 124 mph (200 km/h).

Active Lane Keeping Assist can neither reduce the risk of an accident if you fail to adapt your driving style nor override the laws of physics. It cannot take into account road, weather or traffic conditions. Active Lane Keeping Assist is only an aid. You are responsible for maintaining a safe distance, for vehicle speed, for braking in good time and for staying in lane.

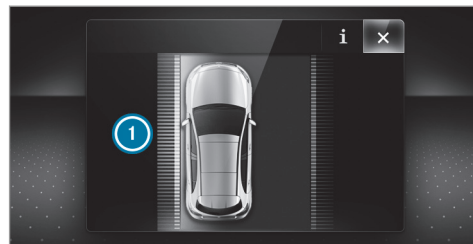

If a lane-correcting brake application occurs, display **1** will appear on the instrument display.

The system does not apply the brake on the corresponding side if you activate the turn signal indicator.

**Vehicles with Driving Assistance Package:** if the system detects an obstacle, such as another vehicle in the adjacent lane, it will apply the brake regardless of the turn signal indicator.

You will be warned by vibrations in the steering wheel in the following circumstances:

- Active Lane Keeping Assist detects a lane marking.
- A front wheel drives over this lane marking.

**Conditions for a course-correcting brake application (vehicles without Driving Assistance Package)**

Lane markings were detected on both sides of the lane. The front wheel drives over a continuous lane marking.

- ⓘ A brake application may be interrupted at any time by steering slightly in the opposite direction.

**Conditions for a course-correcting brake application (vehicles with Driving Assistance Package)**

- A continuous lane marking was detected and driven over with the front wheel.
- A lane marking and an oncoming vehicle, an overtaking vehicle or vehicles driving parallel

to your vehicle were detected in the adjacent lane. The front wheel drives over the lane marking.

- ⓘ A brake application may be interrupted at any time by steering slightly in the opposite direction.

**System limits**

No lane-correcting brake application will occur in the following situations:

- You clearly and actively steer, brake or accelerate.
- If a driving safety system intervenes, such as ESP®, Active Brake Assist or Active Blind Spot Assist.
- You have adopted a sporty driving style with high cornering speeds or high rates of acceleration.
- When ESP® is deactivated.
- If a loss of tire pressure or a defective tire is detected and displayed.

If you deactivate the Active Lane Keeping Assist warning and the lane markings were not clearly

detected, it is possible that no lane-correcting brake application will take place (→ page 187).

The system may be impaired or may not function particularly in the following situations:

- If there is poor visibility, e.g. due to insufficient illumination of the road, highly variable shade conditions, rain, snow, fog or heavy spray.
- If there is glare, e.g. from oncoming traffic, the sun or reflections.
- If there is dirt on the windshield in the vicinity of the multifunction camera or if the camera is fogged up, damaged or obscured.
- If there are no lane markings or several unclear lane markings are present for one lane, e.g. around roadworks.
- If the lane markings are worn, dark or covered.
- If the distance to the vehicle in front is too short and thus the lane markings cannot be detected.
- If the lane markings change quickly, e.g. lanes branch off, cross one another or merge.
- If the road is very narrow and winding.

- **Vehicles with Driving Assistance Package:** if the radar sensors in the rear bumper are dirty or covered in snow and an obstacle is detected in your lane, no lane-correcting brake application takes place.

### Activating/deactivating Active Lane Keeping Assist

#### **⚠ WARNING** Risk of accident despite Active Lane Keeping Assist warning

A lane-correcting brake application cannot always bring the vehicle back into the original lane.

- ▶ Always steer, brake or accelerate yourself, especially if Active Lane Keeping Assist warns you or makes a lane-correcting brake application.

#### **⚠ WARNING** Risk of accident despite intervention of Active Lane Keeping Assist

Active Lane Keeping Assist does not detect traffic conditions or road users. The system may make an inappropriate brake application.

The brake application can be interrupted at any time, for example, by steering slightly in the opposite direction.

- ▶ Always make sure that there is sufficient distance to the side for other traffic or obstacles.

#### **⚠ WARNING** Risk of accident despite Lane Keeping Assist

Lane Keeping Assist cannot always clearly detect lane markings.

In such cases, Lane Keeping Assist can:

- give an unnecessary warning
- not give a warning

- ▶ Always pay particular attention to the traffic situation and keep within the lane, especially if Active Lane Keeping Assist alerts you.

Be sure to observe the system limitations of Active Lane Keeping Assist.

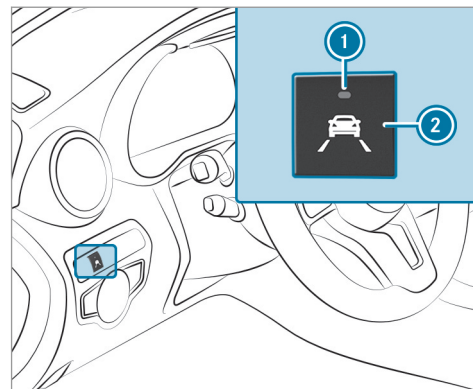

- ▶ Press button ②.

If indicator lamp ① lights up, Active Lane Keeping Assist is activated, the lane markings are shown as light in the assistance graphic. When Active Lane Keeping Assist is active, the lane markings are shown in green in the assistance graphic.

**Setting Active Lane Keeping Assist**

Multimedia system:

→ Vehicle →  Assistance  
 → Act. Lane Keep. Assist

**Activating/deactivating the warning**

▶ Activate  or deactivate  Lane Depart. Warning.

You do not receive any warning when leaving a lane if the lane keeping warning system is deactivated.

**DYNAMIC BODY CONTROL function**

DYNAMIC BODY CONTROL continuously adjusts the characteristics of the suspension dampers to the current operating and driving conditions.

The damping is set individually for each wheel and is affected by the following factors:

- the road surface conditions
- vehicle load
- the drive program selected
- the driving style

The drive program can be adjusted using the DYNAMIC SELECT switch.

**AIRMATIC****Function of AIRMATIC**

AIRMATIC is an air suspension system with variable damping for improved driving comfort. The all-round level control system ensures the best possible suspension and constant ground clearance, even with a laden vehicle. When driving at speed, the vehicle is lowered automatically to improve driving safety and to reduce fuel consumption. You also have the option of manually adjusting the vehicle level.

AIRMATIC includes the following components and functions:

- Air suspension with automatic level control
- Speed-dependent lowering to reduce fuel consumption
- Manually selectable high level setting for greater ground clearance
- ADS PLUS (Adaptive Damping System with constant damping force adjustment)

- DYNAMIC SELECT switch and level button

**Available suspension settings**

**C** (Comfort)

- The suspension setting is comfortable.
- The vehicle is set to the normal level.
- When driving at speeds above 77 mph (125 km/h), the vehicle is lowered.
- When driving at speeds below 50 mph (80 km/h), the vehicle is raised again.

**E** (Economy)

- The suspension setting is comfortable.
- The vehicle is set to the low level.
- The vehicle is not lowered any further if you are traveling at higher speeds.

**S** (Sport)

- The suspension setting is firmer.
- The vehicle is set to the low level.
- The vehicle is not lowered any further if you are traveling at higher speeds.

**S** (Sport Plus)

- The suspension setting is even firmer.
- The vehicle is set to the low level.
- The vehicle is not lowered any further if you are traveling at higher speeds.

**i** **Operation with a trailer or bicycle rack:** if transport equipment, such as a trailer or a bicycle rack, is attached to the trailer hitch and the electrical connection has been correctly established, the vehicle remains at normal level irrespective of speed or the drive program selected.

**Setting the vehicle level**

**⚠ WARNING** Risk of accident because vehicle level is too high

Driving characteristics may be impaired. The vehicle can drift outwards, for example, when steering or cornering.

- ▶ Choose a vehicle level which is suited to the driving style and the road surface conditions.

**⚠ WARNING** Risk of entrapment from vehicle lowering

When lowering the vehicle, people could become trapped if their limbs are between the vehicle body and the tires or underneath the vehicle.

- ▶ Make sure no one is underneath the vehicle or in the immediate vicinity of the wheel arches when the vehicle is being lowered.

**⚠ WARNING** Risk of becoming trapped due to the vehicle lowering

**Vehicles with AIRMATIC or level control:** when you unload luggage or leave the vehicle, the vehicle first rises slightly and then returns to the set level shortly afterwards.

You or anyone else in the vicinity of the wheel arches or the underbody could thus become trapped.

The vehicle can also be lowered after being locked.

- ▶ When leaving the vehicle, make sure that nobody is in the vicinity of the wheel arches or the underbody.

**! NOTE** Damage due to vehicle lowering

Parts of the body could be damaged when the vehicle is lowered.

- ▶ Make sure that there are no obstacles such as curbs underneath or in the immediate vicinity of the body when the vehicle is being lowered.

**Requirements**

- The vehicle has been started.
- The vehicle must not be moving faster than 37 mph (60 km/h).

### Raising the vehicle

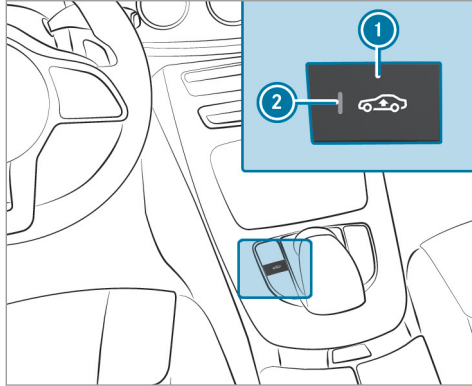

- ▶ Press button ①.
- Indicator lamp ② lights up.
- The vehicle is set to the high level.

Your selection is saved.

The vehicle is lowered again in the following situations:

- When driving faster than 50 mph (80 km/h).
- When driving between 37 mph (60 km/h) and 50 mph (80 km/h) for approximately three minutes.
- After selecting a drive program using the DYNAMIC SELECT switch.

The vehicle is adjusted to the height of the active drive program.

### Lowering the vehicle

- ▶ Press button ①.
- Indicator lamp ② goes out. The vehicle is adjusted to the height of the active drive program.

### Rear view camera

#### Function of the rear view camera

When you engage reverse gear, the image from the rear view camera is shown in the media display. Dynamic guide lines show the path the vehicle will take with the current steering angle. This

helps you to orient yourself and avoid obstacles when backing up.

The rear view camera is only an aid. It is not a substitute for your attention to the surroundings. Responsibility for safe maneuvering and parking always lies with you. Make sure that no persons, animals, objects etc. are in the maneuvering area while you are maneuvering and parking.

The guide lines in the media display show the distances to your vehicle. The distances displayed only apply to road level.

You can select from the following views:

- Normal view
- Wide-angle view

The area behind the vehicle is displayed as a mirror image, as in the inside rear view mirror.

#### Vehicles without Parking Assist PARKTRONIC

The following camera views are available in the multimedia system:

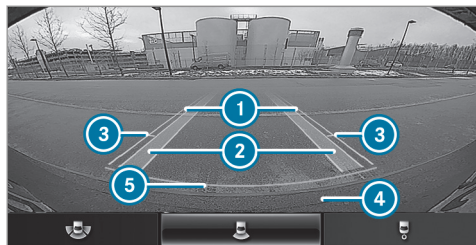

Normal view

- ① Yellow guide line, vehicle width (driven surface) depending on the current steering angle (dynamic)
- ② Yellow lanes marking the course the tires will take with the current steering angle (dynamic)
- ③ Yellow guide line at a distance of approximately 3.3 ft (1.0 m) from the rear area
- ④ Bumper
- ⑤ Red guide line at a distance of approximately 1.0 in (0.3 m) from the rear area



Wide-angle view

### Vehicles with Parking Assist PARKTRONIC

The following camera views are available in the multimedia system:

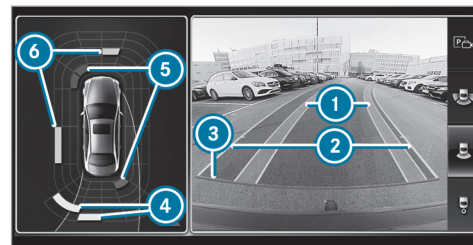

Normal view

- ① Yellow lanes marking the course the tires will take with the current steering angle (dynamic)
- ② Yellow guide line, vehicle width (driven surface) depending on the current steering angle (dynamic)
- ③ Red guide line at a distance of approximately 1.0 in (0.3 m) from the rear area
- ④ Yellow warning indicator of Parking Assist PARKTRONIC: obstacles at a distance between approximately 2.0 ft (0.6 m) and 3.3 ft (1.0 m)



- 5 Red warning display of Parking Assist PARKTRONIC: obstacles are very close (approximately 1.0 ft (0.3 m) or less)
- 6 Orange warning display of Parking Assist PARKTRONIC: obstacles are a medium distance away (between approximately 1.0 ft (0.3 m) and 2.0 ft (0.6 m))



Wide-angle view

### System failure

If the rear view camera is not operational, the  symbol appears in the media display.

### System limits

The rear view camera will not function or will function only partially in the following situations:

- The trunk lid is open.
  - There is heavy rain, snow or fog.
  - The ambient light is poor, e.g. at night.
  - Cameras – or the vehicle components in which the cameras are installed – are damaged, dirty or covered. Observe the information on vehicle sensors and cameras (→ page 155).
- ⓘ Do not use the rear view camera in these situations. You could otherwise injure others or collide with objects when parking the vehicle.

For technical reasons, the standard height of the vehicle may be altered if the vehicle is carrying a heavy load and can result in inaccuracies in the guide lines and in the display of the generated images.

- ⓘ The media display contrast may be impaired due to incident sunlight or other light sources. In this case, pay particular attention.

- ⓘ Have the media display repaired or replaced if, for example, pixel errors considerably restrict its use.

### 360° camera

#### Function of the 360° Camera

The 360° Camera is a system that consists of four cameras. The cameras cover the immediate vehicle surroundings. The system assists you when you are parking or at exits with reduced visibility, for example.

The views from the 360° Camera are always available when the car is being driven forward up to a speed of approximately 10 mph (16 km/h) and when you are backing up.

The 360° Camera is only an aid. It is not a substitute for your attention to the surroundings. Responsibility for safe maneuvering and parking always lies with you. Make sure that no persons, animals, objects etc. are in the maneuvering area while you are maneuvering and parking.

## 192 Driving and parking

The system evaluates images from the following cameras:

- Rear view camera
- Front camera
- Two side cameras in the outside mirrors

### Views of the 360° Camera

You can select from different views:

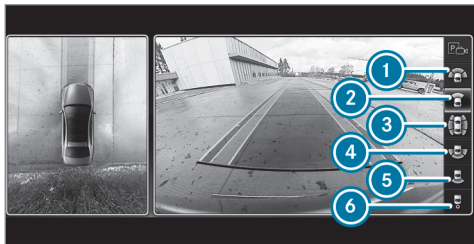

- ① Wide-angle view, front
- ② Top view with image from the front camera
- ③ Top view with images from the side cameras in the outside mirrors
- ④ Wide-angle view, rear

- ⑤ Top view with image from the rear view camera
- ⑥ Top view with trailer view (vehicles with a trailer hitch)

### Top view

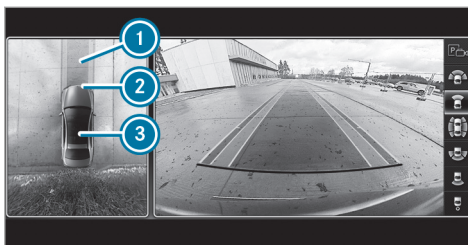

- ① Lane indicating the route that the vehicle will take at the current steering wheel angle
- ② Yellow warning display of Parking Assist PARKTRONIC: obstacles at a distance of approximately 3.3 ft (1.0 m) or less
- ③ Your vehicle from above

As the distance to the object lessens, the color of warning display ② changes. From a distance of

approximately 2.0 ft (0.6 m), the warning display is shown in orange. From a distance of approximately 1.0 ft (0.3 m), the warning display is shown in red.

When Parking Assist PARKTRONIC is operational and no object is detected, the segments of the warning display are shown in gray.

### Guide lines

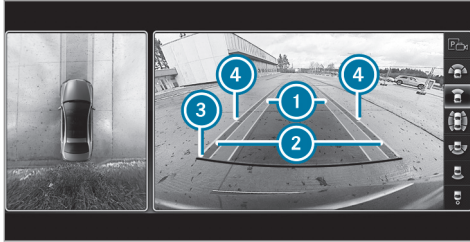

- ① Yellow lane marking the course the tires will take at the current steering wheel angle (dynamic)
- ② Yellow guide line, vehicle width (driven surface) depending on the current steering wheel angle (dynamic)
- ③ Red guide line at a distance of approximately 1.0 in (0.3 m) from the rear area
- ④ Mark at a distance of approx. 3.3 ft (1.0 m)
- i When Active Parking Assist is active, the lane markings are displayed in green.

The guide lines show the distances to your vehicle. The distances apply only at road level.

### Side view of the mirror cameras

The sides of the vehicle can be seen in this view.

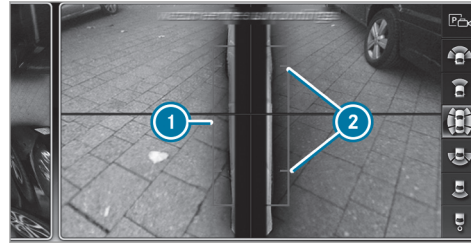

- ① Guide line of external vehicle dimensions with outside mirrors folded out
- ② Marker of the wheel contact points

### System limits

If the rear view camera is not operational, the following symbol appears in the media display.



### System limits

The 360° Camera will not function or will function only partially in the following situations:

- The doors are open.
- The side mirrors are folded in.
- The trunk lid is open.
- There is heavy rain, snow or fog.
- The ambient light is poor, e.g. at night.
- Cameras – or the vehicle components in which the cameras are installed – are damaged, dirty or covered. Observe the information on vehicle sensors and cameras (→ page 155).

Do not use the 360° Camera under such circumstances. You could otherwise injure others or collide with objects when parking or maneuvering the vehicle.

On vehicles with height-adjustable suspension or if the vehicle is carrying a heavy load, leaving the standard height can result in inaccuracies in the guide lines and in the display of the generated images, depending on technical conditions.

- ❗ The contrast of the media display may be impaired by abrupt, direct sunlight or by other light sources (e.g. when you drive out of a garage). In this case, pay particular attention.
- ❗ Have the media display repaired or replaced if, for example, pixel errors considerably restrict its use.

See the notes on cleaning the 360° Camera (→ page 332).

### Selecting a view for the 360° Camera

#### Requirements

- The **Auto. Rear View Cam.** function is selected in the multimedia system.
- ▶ Engage reverse gear.
  - ▶ In the multimedia system, select the desired view.

### Opening the rear view camera cover

Multimedia system:

➔ **Vehicle** ➔  **Assistance**  
 ➔ **Camera & Parking**

▶ Select **Open Camera Cover**.

- ❗ The camera cover closes automatically after some time or after an ignition cycle.

### Setting the camera as a favorite

You can call up the camera view directly in the multimedia system by setting it as a favorite.

- ▶ Press the  button on the control element. The main functions are displayed.
- ▶ Navigate downwards twice. The Favorites menu appears.
- ▶ Select **New Favorite**.
- ▶ Select **Vehicle**.
- ▶ Select **Camera**.

### Parking Assist PARKTRONIC

#### Function of Parking Assist PARKTRONIC

Parking Assist PARKTRONIC is an electronic parking assistance system with ultrasound. It monitors the area around your vehicle using multiple sensors on the front and rear bumper. Parking Assist PARKTRONIC shows you the distance between your vehicle and a detected obstacle visually and audibly.

Parking Assist PARKTRONIC is only an aid. It is not a substitute for your attention to the surroundings. Responsibility for safe maneuvering and parking remains with you. Make sure that there are no persons, animals or objects in the maneuvering area while you are maneuvering or moving into / out of parking spaces.

In the standard setting, an intermittent warning tone sounds from a distance of approximately 1.0 ft (0.3 m) to an obstacle in front and approximately 3.3 ft (1.0 m) to an obstacle behind. A continuous warning tone sounds from a distance of approximately 0.7 ft (0.2 m). Using the **Warn Early** setting in the multimedia system, the warning tones for front and side impact protection can

be set to sound at a greater distance of approximately 3.3 ft (1.0 m) in front and 2.0 ft (0.6 m) on the sides (→ page 198).

**i** The **Warn Early** setting is always active in the rear passenger compartment of the vehicle.

### Parking Assist PARKTRONIC display in the multimedia system

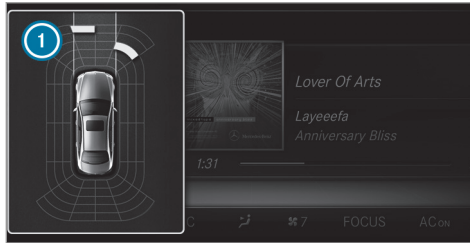

Vehicles without 360° Camera



Vehicles with 360° Camera

If you have not selected the **Camera & Parking** menu and an obstacle is detected in the path of the vehicle, a pop-up window for Parking Assist PARKTRONIC **1** appears in the multimedia system at speeds below 6 mph (10 km/h).

The color of the individual segments of the warning display is based on the distance to the detected obstacle:

- **Yellow segments:** obstacles at a distance between approx. 2.0 ft (0.6 m) and 3.3 ft (1.0 m)

- **Orange segments:** obstacles at a distance between approx. 1.0 ft (0.3 m) and 2.0 ft (0.6 m)
- **Red segments:** obstacles at a very short distance of approx. 1.0 ft (0.3 m) or less

### System limits

Parking Assist PARKTRONIC may sometimes not take into account the following obstacles:

- Obstacles below the detection range, e.g. persons, animals or objects.
- Obstacles above the detection range, e.g. overhanging loads, overhangs or loading ramps of trucks.

The sensors must be free of dirt, ice and slush. Otherwise, they may not function correctly. Clean the sensors regularly, taking care not to scratch or damage them(→ page 155).

### Problems with Parking Assist PARKTRONIC

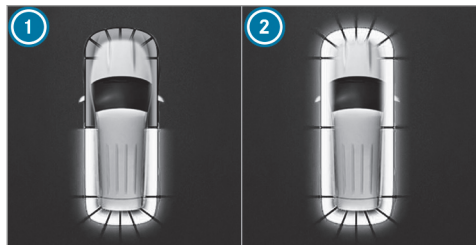

Example: vehicles with 360° Camera

When rear segments ❶ or all-around segments ❷ light up red and the  symbol appears in the Instrument Display, Parking Assist PARKTRONIC may have been deactivated due to signal interference. Start the vehicle again and check if Parking Assist PARKTRONIC is working at a different location.

If a warning tone also sounds for approximately two seconds every time the vehicle is started, it may be due to one of the following causes:

- **The sensors are dirty:** clean the sensors and observe the notes on care of vehicle parts (→ page 332).
- **Parking Assist PARKTRONIC has been deactivated due to a malfunction:** restart the vehicle. If the problem persists, consult a qualified specialist workshop.

#### Function of the passive side impact protection

Passive side impact protection is an additional Parking Assist PARKTRONIC function which warns the driver about obstacles at the side of the vehicle. A warning is issued when obstacles are detected between the front and rear detection range. In order for an object on the side to be detected, the sensors in the front and rear bumper must first detect the object while you are driving past it.

During the parking procedure or maneuvering, objects are detected as the vehicle drives past. If you steer in the direction of a detected obstacle and there is a risk of a lateral collision, a warning

is issued and the segments light up in color on the display.

The segment color changes depending on the distance to the detected obstacle:

- **Yellow:** approximately 1.0 - 2.0 ft (30 - 60 cm)
- **Red:** less than approximately 1.0 ft (30 cm)

In order for lateral, front or rear segments to be displayed, the vehicle must first travel a distance of at least half a vehicle's length. Once the vehicle has travelled the length of the vehicle, all of the lateral front and rear segments can be displayed.

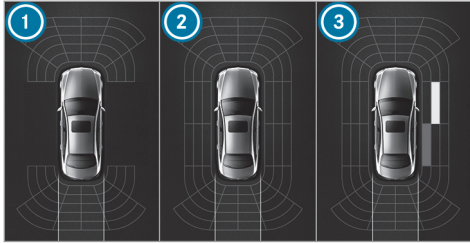

Parking Assist PARKTRONIC display: vehicles without a surround view camera

- ① Operational front and rear
- ② Operational front, rear and sides
- ③ Obstacle detected at the front right (yellow) and rear (red)

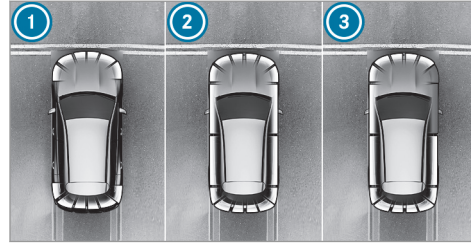

Parking Assist PARKTRONIC display: vehicles with a surround view camera

- ① Operational front and rear
- ② Operational front, rear and sides
- ③ Obstacles detected at the front right (red)

Saved obstacles on the sides are deleted in the following situations, for example:

- You park the vehicle and switch it off.
- You open the doors.

After the engine is restarted, obstacles on the sides must be detected again before a new warning can be issued.

### System limits

The system limits for Parking Assist PARKTRONIC apply to passive side impact protection.

The following objects are not detected, for example:

- Pedestrians who approach the vehicle from the side
- Objects placed next to the vehicle



### Activating/deactivating Parking Assist PARKTRONIC

**!** **NOTE** Risk of an accident from objects at close range

Parking Assist PARKTRONIC may not detect certain objects at close range.

- ▶ When parking or maneuvering the vehicle, pay particular attention to any objects which are above or below the sensors, e.g. flower pots or drawbars. The vehicle or other objects could otherwise be damaged.

▶ Press the  button in the center console.

If the indicator lamp in the  button is not lit, Parking Assist PARKTRONIC is active. If the indicator lamp is lit or the  symbol appears in the Instrument Display, Parking Assist PARKTRONIC is not active.



-  Parking Assist PARKTRONIC is automatically activated when the vehicle is started.

### Setting the warning tones of Parking Assist PARKTRONIC

Multimedia system:

-  **Vehicle**   **Assistance**
-  **Camera & Parking**  **Set Warning Tones**

### Adjusting the volume of the warning tones



-  Select **Warning Tone Volume**.
-  Set a value.

### Adjusting the pitch of the warning tones

-  Select **Warning Tone Pitch**.
-  Set a value.



### Specifying the starting point for the warning tones

You can specify whether the Parking Assist PARKTRONIC warning tones should commence when the vehicle is further away from an obstacle.

-  Select **Warn Early**.
-  Activate  or deactivate  the function.

### Activating/deactivating audio fadeout

You can specify whether the volume of a media source in the multimedia system is to be reduced when Parking Assist PARKTRONIC gives an audible warning.

-  Select **Audio Fadeout During Warning Tones**.
-  Activate  or deactivate the  function.

### Active Parking Assist

#### Function of Active Parking Assist

Active Parking Assist is an electronic parking assistance system that uses ultrasound supported by the rear view camera or 360° camera. When you are driving forwards up to approximately 22 mph (35 km/h), the system automatically measures parking spaces on both sides of the vehicle.

As soon as all requirements are met for searching for parking spaces, the  display appears on the instrument display.

When Active Parking Assist has detected parking spaces, the  display appears on the instrument display. The arrows show on which side of the road detected parking spaces are located. They are then shown on the media display.

The parking space can be selected as desired. Depending on the location of the parking space, the parking direction (forwards or reverse) can also be selected as desired.

When Active Parking Assist is activated, the turn signal indicators are activated based on the calculated path of your vehicle.

When you are entering or exiting a parking space, the procedure is assisted by acceleration, braking, steering and gear changes.

Active Parking Assist is only an aid. It is not a substitute for your attention to the surroundings. The responsibility for safe maneuvering and parking remains with you. Make sure that no persons, animals or objects are in the vehicle's path.



Active Parking Assist will be canceled in the following situations:

- Parking Assist PARKTRONIC is deactivated.
- You begin steering.
- You apply the parking brake.
- You engage transmission position **P**.
- ESP® intervenes.
- You open the doors or the trunk lid while the vehicle is in motion.

### System limits

If the exterior lighting is malfunctioning, Active Parking Assist is not available.

Objects located above or below the detection range of the sensors, e.g. overhanging loads, overhangs or loading ramps of goods vehicles, or the borders of parking spaces, are not detected during measurement of the parking space. These are then not taken into account in the calculation of the parking procedure either. In some circumstances, Active Parking Assist may therefore guide you into the parking space incorrectly.

**⚠ WARNING** Risk of accident due to objects located above or below the detection range of Active Parking Assist

If there are objects above or below the detection range, the following situations may arise:

- Active Parking Assist may steer too early.
- The vehicle may not stop in front of these objects.

There is a danger of collision!

▶ In these situations, do not use Active Parking Assist.

Extreme weather conditions, such as snow or heavy rain, may lead to a parking space being measured inaccurately. Parking spaces that are partially occupied by trailer drawbars might not be identified as such or may be measured incorrectly. Only use Active Parking Assist on level, high-grip ground.

Do not use Active Parking Assist in the following situations:

- In extreme weather conditions, e.g. ice, packed snow or in heavy rain.

- When transporting a load that protrudes beyond the vehicle.
- On steep uphill or downhill gradients of more than approximately 15%.
- When snow chains are mounted.
- Directly after a tire change or when spare tires are mounted.
- If the tire pressure is too low or too high.
- If the suspension is out of alignment, e.g. after bottoming out on a curb.

Active Parking Assist may also display parking spaces that are not suitable for parking, such as:

- Parking spaces where parking is prohibited.
- Parking spaces on unsuitable surfaces.

### Parking with Active Parking Assist

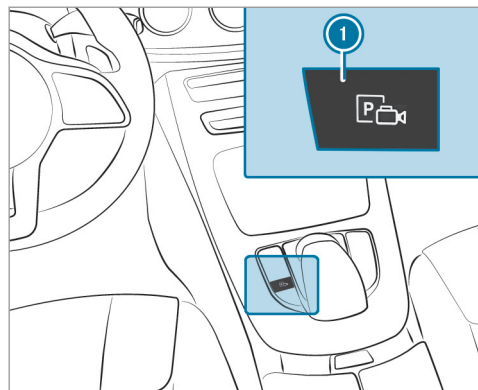

▶ Press button ①.



The media display shows the view of Active Parking Assist. Area ② displays detected parking spaces ④ and vehicle path ③.

- ① Vehicle path ③ shown on the media display may differ from the actual vehicle path.
- ▶ If a parking space is displayed: stop the vehicle.
- ▶ Select desired parking space ④ and confirm.
- ▶ If necessary, select the parking direction (forwards or reverse), and confirm. Vehicle path ③ is shown, depending on selected parking space ④ and the parking direction.

① The turn signal indicator is switched on automatically when the parking procedure begins.

You are responsible for selecting the turn signal indicator in accordance with the traffic conditions. If necessary, select the turn signal indicator accordingly.

**⚠ WARNING** Risk of accident due to vehicle swinging out while parking or pulling out of a parking space

While parking or exiting a parking space, the vehicle swings out and can drive onto areas of the oncoming lane.

This could cause you to collide with objects or other road users.

- ▶ Pay attention to objects and other road users.
- ▶ Where necessary, stop the vehicle or cancel the parking procedure with Active Parking Assist.

▶ If, for example, the **Please Engage Reverse Gear** message appears in the media display:

select the corresponding transmission position.  
The vehicle drives into the selected parking space.

- During the parking procedure with Active Parking Assist, the lane markings are displayed in green in the camera image.

On completion of the parking procedure, the  **Parking Assist Finished, Take Control of Vehicle** display message appears. Further maneuvering may still be necessary.

- After completion of the parking procedure, safeguard the vehicle against rolling away. When required by legal requirements or local conditions: turn the wheels towards the curb.
- You can stop the vehicle and change the transmission position during the parking procedure. The system then calculates a new vehicle path. If no new vehicle path is available, the system can change the transmission position again or cancel the parking procedure.

### Exiting a parking space with Active Parking Assist

#### Requirements:

- The vehicle has been parked with Active Parking Assist.

Please note that you are responsible for the vehicle and surroundings during the entire parking procedure.

- Start the vehicle.

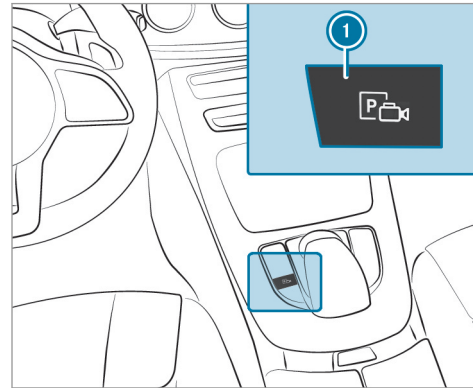

- Press button **1**.  
The media display shows the view of Active Parking Assist.



- If the vehicle has been parked perpendicular to the direction of travel: in area **2**, select direction of travel **3** **Left** or **Right**.
- The vehicle path shown on the media display may differ from the actual vehicle path.
- Confirm direction of exit **3** to drive out of the parking space.
- The turn signal indicator is switched on automatically when the exiting procedure begins.

You are responsible for selecting the turn signal indicator in accordance with the traffic conditions. If necessary, select the turn signal indicator accordingly.

**⚠ WARNING** Risk of accident due to vehicle swinging out while parking or pulling out of a parking space

While parking or exiting a parking space, the vehicle swings out and can drive onto areas of the oncoming lane.

This could cause you to collide with objects or other road users.

- ▶ Pay attention to objects and other road users.
- ▶ Where necessary, stop the vehicle or cancel the parking procedure with Active Parking Assist.

▶ If, for example, the **Please Engage Forward Gear** message appears in the media display:

select the corresponding transmission position.

The vehicle moves out of the parking space.

The turn signal indicator is switched off automatically.

After the parking space has been exited, a warning tone and the  **Parking Assist Finished, Take Control of Vehicle** message prompt you to take control of the vehicle.

The vehicle is not automatically braked and can roll away. You have to accelerate, brake, steer and change gear yourself again.

### Maneuvering assistance

#### Function of Drive Away Assist

Drive Away Assist can reduce the severity of an impact when the vehicle is pulling away. If an obstacle is detected in the direction of travel, the vehicle's speed is briefly reduced to approx. 1 mph (2 km/h). If a critical situation is detected, the  symbol appears in the media display.

Drive Away Assist can be deactivated or activated in the **Maneuvering Assistance** menu (→ page 203).

**ⓘ** You can cancel an intervention by Drive Away Assist at any time by deactivating Parking Assist PARKTRONIC (→ page 197).

**⚠ WARNING** Risk of accident caused by limited detection performance of Drive Away Assist

Drive Away Assist cannot always clearly identify objects and traffic situations.

- ▶ Always pay careful attention to the traffic situation; do not rely on Drive Away Assist alone.
- ▶ Be prepared to brake or swerve as necessary, provided the traffic situation permits and that it is safe to take evasive action.

Drive Away Assist is only an aid. It is not a substitute for your attention to the surroundings. Responsibility for safe maneuvering and parking remains with you. Make sure that no persons, ani-

mals or objects etc. are in the maneuvering range.

A risk of collision may occur in the following situations, for example:

- If the accelerator and brake pedals are confused.
- If an incorrect transmission position is engaged.

Drive Away Assist is active under the following conditions:

- If Parking Assist PARKTRONIC is activated.
- If you shift the transmission position to **R** or **D** when the vehicle is stationary.
- If the detected obstacle is less than approx. 3.3 ft (1.0 m) away.
- If the maneuvering assistance function is activated in the multimedia system.

### System limits

The performance of Drive Away Assist is limited on inclines.

- ① Also observe the system limits of Parking Assist PARKTRONIC (→ page 194).

### Function of Cross Traffic Alert

- ① Cross Traffic Alert is available only for vehicles with Blind Spot Assist or Active Blind Spot Assist.

Cross Traffic Alert can warn drivers of any crossing traffic when you are reversing out of a parking space or performing other maneuvers. The radar sensors in the bumper also monitor the area adjacent to the vehicle. If a critical situation is detected, the  symbol appears in the media display and the vehicle can be braked automatically.

If the radar sensors are obstructed by vehicles or other objects, detection is not possible.

Cross Traffic Alert is active under the following conditions:

- if the vehicle is backing up at walking pace.
- maneuvering assistance is activated (→ page 203).
- ① Also observe the instructions on Blind Spot Assist and Active Blind Spot Assist (→ page 181).

### System limits

Cross Traffic Alert is not available on inclines.

### Activating or deactivating maneuvering assistance

Multimedia system:

➔ **Vehicle** ➔  **Assistance**  
➔ **Camera & Parking** ➔ **Maneuvering Assist.**

▶ Activate  or deactivate  the function.

- ① Maneuvering assistance must be active for the function of Drive Away Assist (→ page 202) and Cross Traffic Alert (→ page 203).

### Vehicle towing instructions

The vehicle is not suitable for use of tow bar systems used for flat towing or dinghy towing, for example. Attaching and using tow bar systems can result in damage to the vehicle. When you are towing a vehicle with tow bar systems, safe driving characteristics cannot be guaranteed for the towing vehicle or the towed vehicle. The vehicle-trailer combination may swerve from side to side.

Observe the following information:

- Permitted towing methods (→ page 349)

## 204 Driving and parking

---

- Notes on towing with both axles on the ground  
(→ page 350)

### Notes on the instrument display and on-board computer

**⚠ WARNING** Risk of accident if the instrument display fails

If the instrument display has failed or is malfunctioning, function restrictions in systems relevant to safety cannot be detected.

The operating safety of your vehicle may be impaired.

- ▶ Drive on carefully.
- ▶ Have the vehicle checked immediately at a qualified specialist workshop.

**⚠ WARNING** Risk of distraction from information systems and communications equipment

If you operate information systems and communication devices integrated in the vehicle when driving, you could be distracted from the traffic situation. This could also cause you to lose control of the vehicle.

- ▶ Only operate this equipment when the traffic situation permits.
- ▶ If you cannot be sure of this, stop the vehicle whilst paying attention to road and traffic conditions and operate the equipment with the vehicle stationary.

**! NOTE** Mercedes-AMG vehicles

- ▶ Observe the notes in the Supplement. You could otherwise fail to recognize dangers.

You must observe the legal requirements for the country in which you are currently driving when operating the on-board computer.

The on-board computer shows only display messages and warnings from specific systems on the instrument display. You must therefore ensure that your vehicle is always safe to operate.

If the operating safety of your vehicle is impaired, park the vehicle immediately and in accordance with the traffic conditions. Contact a qualified specialist workshop.

## Overview of instrument display

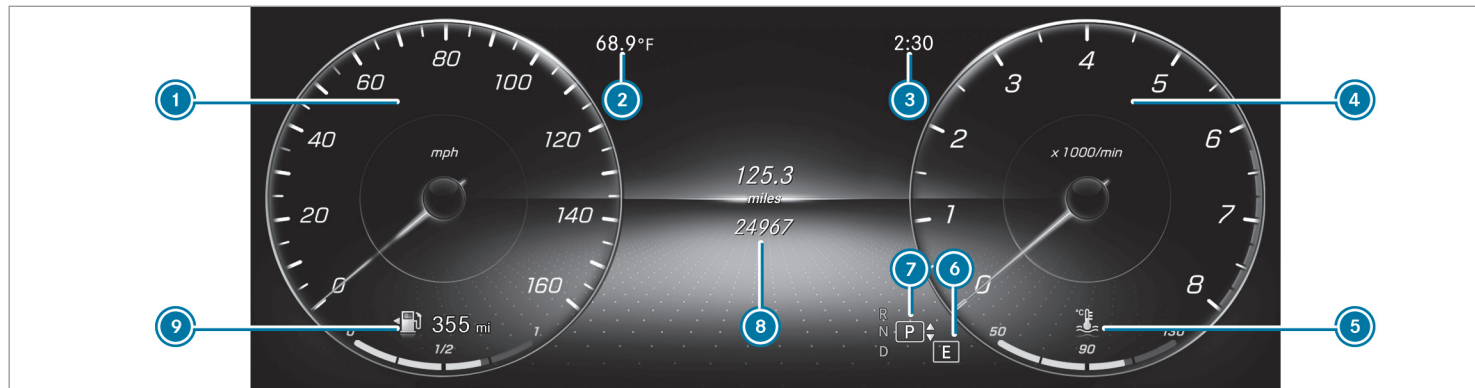





- ① Speedometer  
The segments on the speedometer indicate the statuses of the following systems: cruise control/limiter/Active Distance Assist DISTRONIC
- ② Outside temperature
- ③ Time
- ④ Area for additional values (example: tachometer): tachometer/navigation/ECO display/consumption/G-meter/date
- ⑤ Coolant temperature display  
During normal operation, the coolant temperature display is permitted to rise to 248°F (120°C).
- ⑥ Selected drive program
- ⑦ Selected transmission position
- ⑧ Center display area of the instrument display (example: standard display for a trip): assistance/telephone/navigation/trip/media/radio/styles and displays/service/possible settings for head-up display
- ⑨ Fuel level and fuel filler flap location indicator

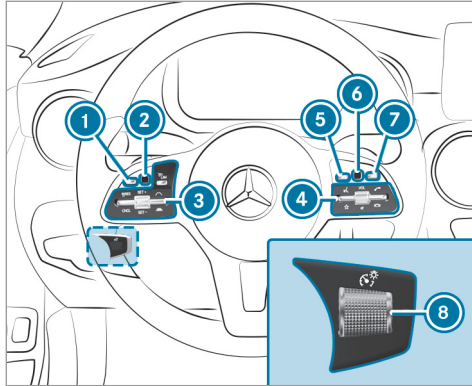

### Overview of buttons on the steering wheel



- ①  Back/Home button (press and hold), on-board computer
- ② Touch Control, on-board computer
- ③ Control panel for cruise control or Active Distance Assist DISTRONIC
- ④ Control panel for the multimedia system
-  Voice Control System (→ page 211)

- ⑤  Main menu, multimedia system
- ⑥ Touch Control, MBUX multimedia system
- ⑦  Back button, MBUX multimedia system
- ⑧ Brightness control to adjust the lighting in the Instrument Display and in the control elements of the vehicle interior

### Operating the on-board computer

Observe the legal requirements for the country in which you are currently driving when operating the on-board computer.



The on-board computer is operated using the left-hand Touch Control and the left-hand back/home button.

When the on-board computer is being operated, different acoustic signals will sound as operating feedback, e.g. when the end of a list is reached.

The following menus are available:

- [Service](#)
- [DriveAssist](#)
- [Trip](#)
- [Navigation](#)
- [Radio](#)
- [Media](#)
- [Phone](#)
- [Head-up Disp.](#)
- **Vehicles with an instrument display in the widescreen cockpit:** [Designs](#)

- ① You can find information about the possible settings and selections on the menus in the Digital Operator's Manual.

The menu can be called up from the menu bar on the instrument display.

- ▶ **To call up the menu bar:** press the left-hand back button until the menu bar is displayed.
- ❶ Press the  button to call up the menu bar of the on-board computer.
- ▶ **To scroll in the menu bar:** swipe to the left or right on the left-hand Touch Control.
- ▶ **To call up a menu, submenu or possible settings on the menu, or confirm a selection or setting:** press the left-hand Touch Control.
- ▶ **To scroll through displays or lists on the menu, or select display content, a function, an entry or a display:** swipe upwards or downwards on the left-hand Touch Control.
- ▶ **To change between displays:** swipe upwards or downwards on the left-hand Touch Control.
- ▶ **To exit a submenu:** press the left-hand back button.

### Displaying full-screen menus





You can display the following menus full-screen on the instrument display:







- DriveAssist
- Trip

- ▶ On the corresponding menu, use the left-hand Touch Control to scroll to the end of the list.
- ▶ Press the left-hand Touch Control. The selected menu will be displayed full-screen.

### Overview of displays on the instrument display

Displays on the instrument display:

-  Active Parking Assist activated (→ page 199)
-  Parking Assist PARKTRONIC deactivated (→ page 197)
-  Cruise control (→ page 162)
-  Active Distance Assist DISTRONIC (→ page 164)
-  Active Brake Assist (→ page 179)

-  Active Steering Assist (→ page 170)
-  Active Lane Keeping Assist (→ page 184)
-  Active Lane Change Assist (→ page 174)
-  ECO start/stop function (→ page 136)
-  HOLD function (→ page 159)
-  Adaptive Highbeam Assist (→ page 115)

**Vehicles with Traffic Sign Assist:** Detected instructions and traffic signs (→ page 180)

### Head-up Display

#### Function of the head-up display

**!** NOTE Mercedes-AMG vehicles

- ▶ Observe the notes in the Supplement. You could otherwise fail to recognize dangers.

The head-up display projects the following into the driver's field of vision:

- Information from the navigation system

- Information from the driver assistance systems
- Some warning messages

### Display content

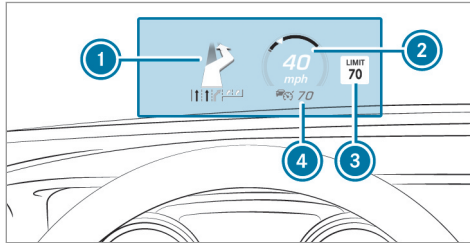

- ① Navigation instructions
- ② Current speed
- ③ Detected instructions and traffic signs
- ④ Set speed in the driver assistance system (e.g. cruise control)

When you receive a call, the  **Incoming Call** message will appear on the head-up display.

In audio mode, the station name or track will be shown temporarily when the audio source is being actively operated.

### System limits

The visibility is influenced by the following conditions:

- Seat position
  - Image position setting
  - Ambient light
  - Wet road surfaces
  - Objects on the display cover
  - Polarization in sunglasses
- ① In extreme sunlight, sections of the display may appear washed out. You can correct this by switching the head-up display off and on again.

### Adjusting the head-up display settings on the on-board computer

On-board computer:

➔ Head-up Disp.



- ① Setting currently selected
- ② Digital speedometer
- ③ Traffic Sign Assist
- ④ Navigation displays

The following can be adjusted for the head-up display:

- **Position**
- **Brightness**

- Display Content

- ▶ **To select a setting:** swipe upwards or downwards on the left-hand Touch Control.
- ▶ Press the left-hand Touch Control.
- ▶ **To adjust a value:** swipe upwards or downwards on the left-hand Touch Control.
- ▶ Press the left-hand Touch Control.

### Switching the Head-up Display on/off

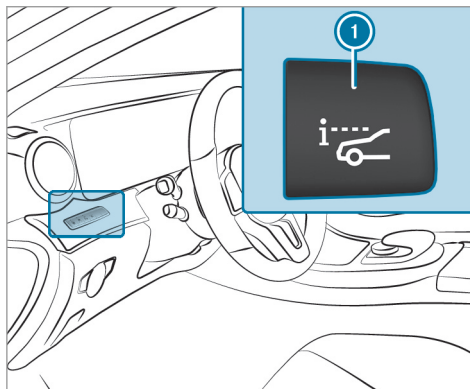

- ▶ Press button ①.

### Notes on operating safety

For your own safety, always observe the following points when operating mobile communications equipment and especially your voice control system:



- Observe the legal requirements for the country in which you are driving.
- If you use the voice control system in an emergency your voice can change and your telephone call, e.g. an emergency call, can thereby be unnecessarily delayed.
- Familiarize yourself with the voice control system functions before starting the journey.

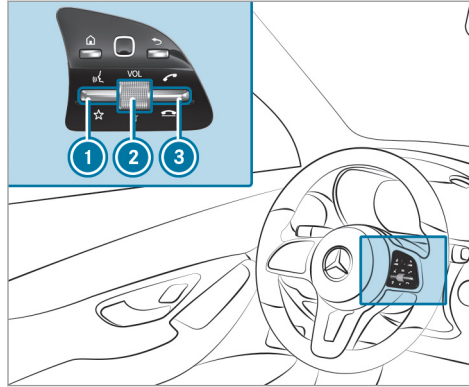

### Operation

#### Overview of operation of the Voice Control System on the multifunction steering wheel

The Voice Control System is operational approximately thirty seconds after the ignition is switched on.



- 1 Press the rocker switch up:  starts the Voice Control System
- 2 Press the control:  switches the sound off or on (ends the Voice Control System)  
Turn the control up/down: increases/decreases the volume

- 3 Press the rocker switch up:  makes/accepts a call  
Press the rocker switch down:  rejects/ends a call (ends the Voice Control System)

#### Conducting a dialog with the Voice Control System

- ▶ **To start or continue a dialog:** on the multifunction steering wheel, press the  rocker switch up.  
You can say a voice command after an acoustic signal.
- ▶ **To correct an entry:** say the Correction voice command.
- ▶ **To select an entry from the selection list:** say the line number or the contents.
- ▶ **To browse the selection list:** say the Next or Back voice command.
- ▶ **To interrupt the dialog:** say the Pause voice command.
- ▶ **To cancel the dialog:** say the Cancel voice command.

### Operable functions

You can use the Voice Control System to operate the following equipment depending on the features:

- Telephone
- Text messages
- Navigation
- Address book
- Radio
- Audio (memory card, Media Interface, USB and Bluetooth® audio)
- Vehicle

### Overview of types of voice command

A distinction is made between the following voice commands:

- **Global voice commands** can be said at any time and regardless of the current application, e.g. the voice commands **Navigate to**, **Call** or **Text message to**.

- **Application-specific voice commands** are only available for the active application.

Once the Voice Control System is started an auto-cue is shown. Apart from the available voice commands for the application currently active, this also cites example voice commands for other applications which are not active. In this way, you will be familiar more quickly with the available voice commands. The list can be scrolled or it can be operated by speech or the controller/touch-pad.

### Information on the language setting

You can change the language of the Voice Control System via the system language settings. If the set system language is not supported by the Voice Control System, English will be selected.

The Voice Control System is available in English, French, Portuguese and Spanish.

### Using the Voice Control System effectively

#### Features of audible help functions

You receive information and help for the following topics:

- **Optimum operation:** say the brief instruction voice command.
- **Current application:** on the multifunction steering wheel, press the  rocker switch up and say the **Help** voice command.
- **Continued dialog:** say the **Help** voice command during a voice dialog.
- **Specific function:** say voice commands for the desired function, e.g. **Help telephone**.

#### Notes on how to improve speech quality

If the Voice Control System does not understand you:

- Only operate the Voice Control System from the driver's seat.
- Say the voice commands coherently and clearly, but do not exaggerate the words.

- Avoid loud noises that cause interference while making a voice command entry, e.g. the blower.

A voice tag in the address book is not recognized:

- Only create sensible address book entries in the system/mobile phone, e.g. enter surname and first name in the correct field.

- Do not use any abbreviations, unnecessary spaces or special characters.

If a station list entry is not recognized:

- Say the "Read out station list" voice command.

can be used regardless of the application that is currently active.

### Essential voice commands

#### Overview of switch voice commands

Switch voice commands can be used to open certain applications. The voice command selection

#### Switch voice commands

Voice command	Function
Navigation	To switch to navigation mode
Map	To switch to map display
Address book	To switch to address book
Telephone	To switch to telephone mode
Text message	To switch to text messages

Voice command	Function
Radio	To switch to radio mode
Media	To switch to media mode
USB	To switch to USB
Memory card	To switch to memory card
Internet application <Name>	To start a Mercedes-Benz online application. The application must be called up once using the multi-media system prior to use.
Mercedes-Benz Apps	To switch to Mercedes-Benz Apps
Connect	To switch to Internet mode
Vehicle menu	To switch to vehicle settings
System settings menu	To switch to system settings

### Overview of navigation voice commands

Using navigation voice commands, you can enter POIs or conventional addresses and make important navigation settings directly.



**Navigation voice commands**

<b>Voice command</b>	<b>Function</b>
Navigate to <Address/POI/Contact>	Universal search for all types of destinations. A search is conducted in the address book contacts, the navigation database and on the Internet (POIs). The order of the details, e.g. city, street or house number, can be changed.
Address in <Country>	Destination entry in a desired country, e.g. address in France
Home	Starts navigation to home address
Work	Starts navigation to your workspace
POI <POI>	Destination entry for a POI, e.g. the POI Brandenburg Gate. A search is performed in the navigation database and on the Internet.
POI online search <POI>	Conducts a POI search on the Internet only
Navigate to contact <Name>	Destination entry to a contact in the address book

Voice command	Function
Enter country Enter city Enter district Enter street Enter intersection Enter house number Enter ZIP code	Enters a country/city/district/street/intersection/house number/ZIP code
Nearest restaurant Nearest parking lot Nearest rest area with restrooms Nearest gas station	Searches for nearby restaurants, parking spaces, rest areas with restrooms and gas stations
Restaurant along the route Parking along the route Rest area with restrooms along the route Gas stations along the route	Searches for restaurants, parking spaces, rest areas with restrooms and gas stations along the route

Voice command	Function
Restaurant at destination Parking at destination Rest area with restrooms at destination Gas station at destination	Searches for restaurants, parking spaces, rest areas with restrooms and gas stations at the destination
Last destinations	Selects a destination from the list of last entered destinations
Alternative routes	Switches route guidance to another route
Start route guidance	Starts route guidance after entering a valid destination
Cancel route guidance	Cancels route guidance
Guidance instructions on Guidance instructions off	Switches the route guidance voice output on/off
Show traffic map Hide traffic map	Switches the traffic map on/off
Switch on POI symbols Switch off POI symbols	Switches the POI symbols display on the map on/off

### Overview of telephone voice commands

You can use the telephone voice commands to make phone calls or search through the address book.

#### Telephone voice commands

Voice command	Function
Call <Name>	Makes a phone call. All address book names are available.
Search for contact <Name>	Searches for and displays a contact. All address book names are available.
outgoing calls	Displays the last call
Redial number	Selects the last phone number dialed

### Overview of radio voice commands

Radio voice commands can also be used when the radio application is running in the background.

**Radio voice commands**

Voice command	Function
Station <Name>	To call up receivable or saved stations
<Frequency>	To enter a frequency directly
Next station	To switch to the next available station
Previous station	To switch to the previous station
Save station	To save a station in the station list
Show station list	To display the names of all receivable stations
Read out station list	To listen to the names of all receivable stations
Traffic information on Traffic information off	To switch the traffic information service on/off
Radio info on Radio info off	To switch information about the current station on/off

**[Overview of media player voice commands](#)**

Media player voice commands can also be used when the media player runs in the background.

**Media player voice commands**

Voice command	Function
Play <Tracks> Play <Albums> Play <Artists> Play<Composers> Play <Genres> Play <Playlists>	The names of all available tracks, albums, artists, composers, genres or playlists are accepted during the search.
Media search <Track> Media search <Albums> Media search <Artists> Media search <Composers> Media search <Genres> Media search <Playlists>	The names of all available tracks, albums, artists, composers, genres or playlists are accepted during the search.

Voice command	Function
Show all albums Show all artists Show all composers Show all genres Show all tracks Show all playlists	Available albums, artists, composers, genres, tracks or playlists are searched for.
Next track	To select the next track
Previous track	To select the previous track
Random playback on Random track list off	To switch the random track list on/off

### Overview of message voice commands

Text messages can be created, edited and listened to using the message voice commands.

### Message voice commands

Voice command	Function
Text message to <Name>	To create a message. All address book names are available.
Reply	To reply to a message
Forward text message	To forward a message

### Overview of vehicle voice commands

You can use the vehicle voice commands to directly call up the corresponding menus for the vehicle settings.

### Vehicle voice commands

Voice command	Function
Ambient light menu	To display ambient light settings
Ambient light "blue"	To switch ambient light to blue
Display and styles menu	To show display settings
Assistance menu	To display assistance settings



Voice command	Function
Scent menu	To display fragrance settings
Energy flow	To display energy flow settings
Ionization menu	To display ionization settings
Climate control menu	To display climate control settings
Automatic climate control driver on	To switch on the automatic climate control settings on the driver's side
Light menu	To display light settings
Relaxation menu	To display massage settings
Massage driver's seat on	To switch on the massage function for the driver's seat
Massage driver's seat off	To switch off the massage function for the driver's seat
Outside temperature	To display the outside temperature
Engine data	To display engine data
Seats menu	To display seat adjustment settings
Seat heating front passenger level "2"	To set the seat heating for the front passenger seat to level 2

## 224 Voice Control System

---

Voice command	Function
Consumption menu	To display consumption
Vehicle data	To display vehicle data

## Overview and operation

### Overview of the multimedia system

**⚠ WARNING** Risk of distraction from information systems and communications equipment

If you operate information systems and communication devices integrated in the vehicle when driving, you could be distracted from the traffic situation. This could also cause you to lose control of the vehicle.

- ▶ Only operate this equipment when the traffic situation permits.
- ▶ If you cannot be sure of this, stop the vehicle whilst paying attention to road and traffic conditions and operate the equipment with the vehicle stationary.

Observe the legal requirements for the country in which you are currently driving when operating the multimedia system.

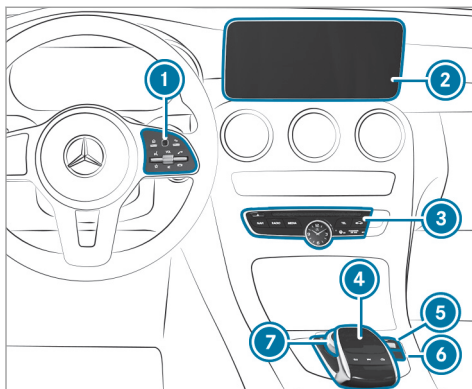

- ① Touch Control  
Multimedia system button group on the steering wheel (→ page 207)
- ② Media display
- ③ Main function button group (→ page 229)
- ④ Touchpad
- ⑤ Controller
  - Adjusts the volume (→ page 231)

- Switches the sound on/off (→ page 230)
- For Mercedes-AMG vehicles with AMG Performance exhaust system:
- Turn: to adjust the volume
  - Press: to switch the multimedia system on/off

⑥  button

- Switches multimedia system on/off
- For Mercedes-AMG vehicles with AMG Performance exhaust system:
- Sets the volume of the AMG Performance exhaust system

⑦ Controller

### Notes on the media display

**!** **NOTE** Scratches on the display

The display has a highly sensitive, high-gloss surface. There is a risk of it becoming scratched.

- ▶ Avoid touching the display.
- ▶ Observe the notes on cleaning.

Observe the notes on caring for the interior (→ page 333).

**Automatic temperature-controlled switch-off feature:** if the temperature is too high, the brightness is initially reduced automatically. The display may then switch off completely for a while.

- ❗ If you are wearing polarized sunglasses, it may be difficult to read the display.

### Central control elements overview

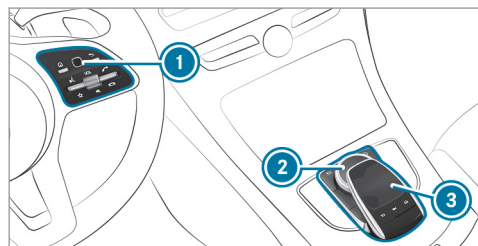

- ① Touch Control
- ② Controller
- ③ Touchpad

### Touch Control

#### Operating Touch Control

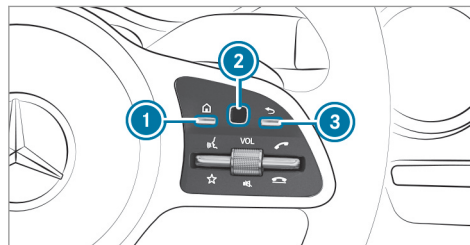

- ▶ Operate the multimedia system with Touch Control ② and associated buttons ① and ③.

#### Calling up the main functions

- ▶ Press button ①.
- or
- ▶ Press button ③ repeatedly until the main functions are shown.

#### Calling up favorites

- ▶ Press button ①.
- ▶ Swipe down on Touch Control ②.

#### Opening and closing a list

- ▶ **To open:** press Touch Control ②.
- ▶ **To close:** press button ③.
- or
- ▶ Swipe right on Touch Control ②.

#### Selecting a menu item

- ▶ Swipe up, down, left or right on Touch Control ②.
- ▶ Press Touch Control ②.

#### Moving the digital map



- ▶ Swipe in any direction.

#### Setting the sensitivity for Touch Control Multimedia system:

- ▶ System ▶ Input
- ▶ Touch Control Sensitivity
- ▶ Select **Fast**, **Medium** or **Slow**.

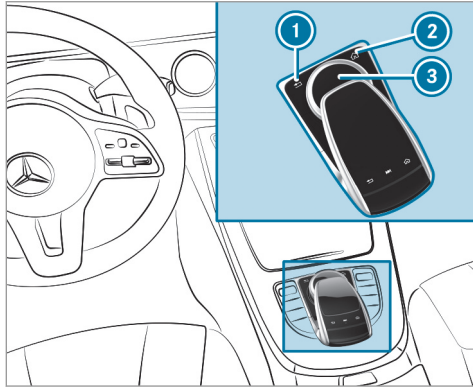
## Operating the controller







- ①  Button  
Press briefly: to return to the previous display  
Press and hold: to call up main functions
- ②  button  
Calling up the main functions

Calls up favorites: when the main functions are displayed, slide controller ③ down.

### ③ Controller

Controller operating options:

- ▶ Turn  counter-clockwise or clockwise.
- ▶ Slide  left or right.
- ▶ Slide  up or down.
- ▶ Slide  diagonally.
- ▶ Press  briefly or press and hold.

## Touchpad

### Switching the touchpad on or off

Multimedia system:

 System  Input



- ▶ Activate  or deactivate  the Touchpad.

### Operating the touchpad

#### Requirements:

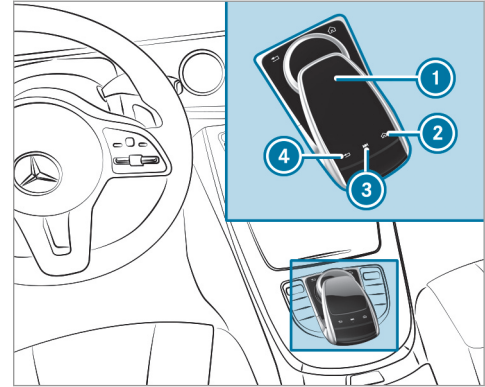
- The touchpad is switched on (→ page 227).



- ① Touchpad
- ②  button  
Calls up main functions and favorites
- ③  button  
Calls up the control menu of the last active audio source

#### 4 button

Pressing briefly: returns to the previous display

You can navigate in menus and lists via touch-sensitive surface  by using **a single-finger swipe**.

- ▶ **To open or close lists:** swipe left or right.
- ▶ **To select a menu item:** swipe up, down, left or right and press touchpad .
- ▶ **To move the digital map:** swipe in any direction.

Using the following functions with a two-finger swipe:

- ▶ **To call up main functions and favorites:** swipe down with two fingers. The swipe must start in the upper area of the touchpad.
- ▶ **To zoom in and out of the map:** move two fingers together or apart.
- ▶ **To call up the control menu of the last active audio source:** swipe up with two fingers. The swipe must start in the lower area of the touchpad.

#### Setting the sensitivity for the touchpad

Multimedia system:

↳ System ▶  Input

- ▶ Select **Touchpad Sensitivity**.
- ▶ Select **Fast**, **Medium** or **Slow**.
- ▶ **To set the pressure sensitivity:** switch **Touchpad Tap** on  or off . If the function is switched on , a tap on the touchpad is enough to select a menu item.

#### Switching the read-aloud function for handwriting recognition on or off

Multimedia system:

↳ System ▶  Audio

▶ System Feedback

- ▶ Switch **Read Out Handwriting Recognition** on  or off .

#### Activating or deactivating haptic operating feedback on the touchpad

Multimedia system:

↳ System ▶  Input

The function supports you when making entries on the touchpad and when selecting menus.

- ▶ Activate  or deactivate  **Haptic Operating Feedback**.

When the function is activated, a tactile feedback in the form of a vibration is effected when the touchpad is operated.

#### Selecting a station and track using the touchpad

- ▶ Press the  button on the touchpad.

or

- ▶ Swipe up with two fingers. The swipe must start in the lower area of the touchpad. The control menu appears for the audio source that was last selected.
- ▶ Use one finger to swipe up or down. Radio: the previous or the next station is set. Media source: the previous or the next music track is selected.
- ▶ **To hide the control menu:** swipe down with two fingers. The swipe must start in the upper area of the touchpad.

## Main functions

### Calling up the main functions

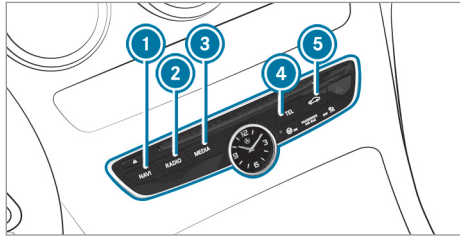

- 1 **NAVI** button  
Calls up navigation
- 2 **RADIO** button  
Calls up the radio
- 3 **MEDIA** button  
Calls up media
- 4 **TEL** button  
Calls up the telephone
- 5  button  
Sets vehicle functions

- ▶ Alternatively: press the  button on the Touch Control, controller or the touchpad. The main functions are displayed.
- ▶ Select the main function.

## Favorites

### Overview of favorites

Favorites offer you quick access to frequently used applications. It is possible to create 20 favorites in total.

The following functions are available:

- Add **pre-defined favorites** from the following categories (→ page 229):
  - **Navigation**
  - **Entertainment**
  - **Phone**
  - **Connect**
  - **Vehicle**
  - **System Settings**
- Add **your own favorites** (→ page 229)
- Rename favorites (→ page 230).

- Move favorites (→ page 230).
- Delete favorites (→ page 230).
- Reset all favorites (→ page 230)

### Calling up favorites

- ▶ Press the  button. The main functions are displayed.
- ▶ Navigate downwards once. Navigating means:
  - Swiping on the Touch Control or the touchpad
  - Sliding the controller

### Leaving the favorites menu

- ▶ Press the  button.

### Adding favorites

#### Adding predefined favorites

- ▶ Press the  button. The main functions are displayed.
- ▶ Navigate downwards twice. The Favorites menu appears.

- ▶ Select **New Favorite**.  
The categories are displayed.
- ▶ Select a category.  
The favorites are displayed.
- ▶ Select a favorite.
- ▶ Store the favorite at the desired position.  
If a favorite has already been added at this position, it will be overwritten.

#### Example: adding your own favorites

- ▶ Select **Vehicle**.
- ▶ Select **Full Screen: Consumption**.
- ▶ Press and hold the  button until the favorites are displayed.
- ▶ Store the favorite at the desired position.

If **No function available for saving** is shown, the selected function cannot be added.

#### Renaming favorites

- ▶ Press the  button.  
The main functions are displayed.
- ▶ Navigate downwards once.
- ▶ Select a favorite.

- ▶ Navigate downwards once.  
The Favorites menu appears.
- ▶ Select **Rename**.
- ▶ Enter the characters.
- ▶ **To confirm the entry:** select .

#### Moving favorites

- ▶ Press the  button.  
The main functions are displayed.
- ▶ Navigate downwards once.
- ▶ Select a favorite.
- ▶ Navigate downwards once.  
The Favorites menu appears.
- ▶ Select **Move**.
- ▶ Move the favorite to the desired position.  
If a favorite has already been added at this position, it will be overwritten.

#### Deleting favorites

- ▶ Press the  button.  
The main functions are displayed.
- ▶ Navigate downwards once.
- ▶ Select a favorite.

- ▶ Navigate downwards once.  
The Favorites menu appears.
- ▶ **To delete:** select **Delete**.
- ▶ Select **Yes**.
- ▶ **To restore all favorites:** select **Reset All**.  
A prompt appears.
- ▶ Select **Yes**.  
The favorites are reset to the factory settings.

#### Switching the sound on/off

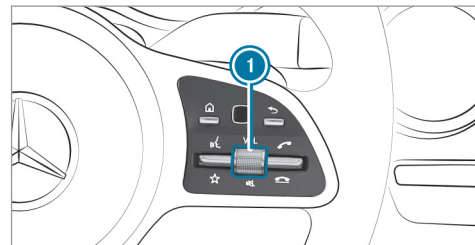

On the multifunction steering wheel



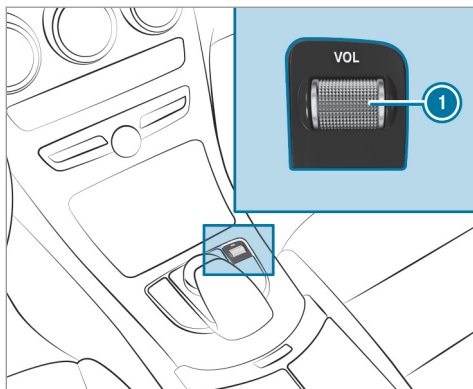

On the multimedia system

- ▶ **To mute:** press volume control ①.  
The  symbol appears in the status line of the display.  
You will also hear traffic announcements and navigation announcements even when the sound is muted.

- ▶ **To switch on:** change the media source or turn volume control ①.

### Adjusting the volume

#### Adjusting with the volume control

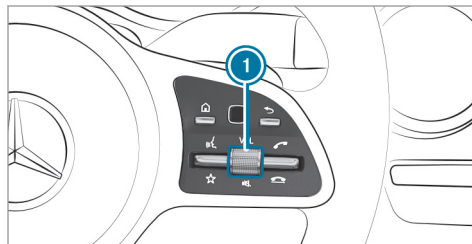

On the multifunction steering wheel

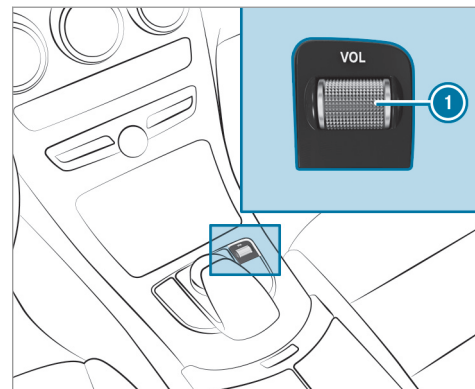

On the multimedia system

- ▶ Turn volume control ①.  
The volume of the current radio or media source is set. The volume of other audio sources can be adjusted separately.  
Adjust this in the following situations:
  - During a traffic announcement
  - During a navigation announcement

The volume of the navigation announcement changes in accordance with the volume of the current media source.

- During a telephone call
- When entering or exiting a parking space while using Active Parking Assist

### Setting in the menu

- ▶ Select **System** in the multimedia system.
- ▶ Select **Audio**.
- ▶ Select a volume setting.
- ▶ Set the volume.

### Entering characters

#### Using the character input function

**⚠ WARNING** Risk of distraction from information systems and communications equipment

If you operate information systems and communication devices integrated in the vehicle when driving, you could be distracted from the

traffic situation. This could also cause you to lose control of the vehicle.

- ▶ Only operate this equipment when the traffic situation permits.
- ▶ If you cannot be sure of this, stop the vehicle whilst paying attention to road and traffic conditions and operate the equipment with the vehicle stationary.

Observe the legal requirements for the country in which you are currently driving when operating the multimedia system.

Use the character input function in the following situations, for example:

- Renaming a favorite.
- Entering a POI or address.
- Making a phone call.

The following functions are available:

- Selecting a character in the character bar.
- Writing a character on the touchpad.

Character input can be started with a control element and resumed with another.

- ▶ **On the Touch Control and controller:** select the characters in the character bar.

Depending on the target entry, the following characters are available:

- The full set of characters is shown.
- Only those characters which are useful for the current input string are shown.

Other characters are grayed out.

- ▶ **On the touchpad:** select the characters in the character bar.

or

- ▶ Write the characters on the touch-sensitive surface of the touchpad. Handwriting recognition supports you by means of character suggestions and a read-aloud function.

Examples of character entry:

- Renaming a favorite.
- Entering a POI or an address using free or step-by-step search.
- Entering a web address.

## Entering characters using the controller

### Example: renaming favorites



- ▶ Call up the "Renaming favorites" function (→ page 230).
- ▶ **To enter a character:** turn **⊙**, slide **↑⊙↓** and press the controller. The character is entered in the input line.

Use the following entry functions:

- ⊗** To delete a character: press the controller. To delete an entry: press and hold the controller until the entire entry is deleted.

- ⋮** To switch to special characters and symbols.
- ⏶** To switch to upper-case or lower-case letters.
- 🌐** To switch the language.
- 🖱** To switch to character entry on the touchpad.
- i** The available editing functions depend on the editing task, the language set and the character level.

- ▶ **To confirm the entry:** select **ok**.

### Example: entering a destination (navigation)

- ▶ Enter the POI or address (→ page 247).

### Entering characters on the touchpad

#### Requirements:

- The touchpad is switched on (→ page 227).
- The entered or selected character should be read out: the handwriting recognition read-aloud function is switched on (→ page 228).

### Example: renaming favorites

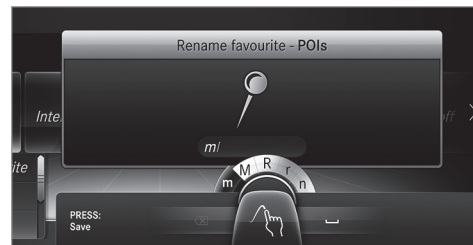

- ▶ Call up the "Renaming favorites" function (→ page 230).
- ▶ **To enter a character:** use your finger to write characters on the touchpad. The character is entered in the input line. If different interpretations are possible, character suggestions are displayed.
- ▶ **To select a character suggestion:** swipe up or down on the touchpad.
- ▶ Resume character input.
- ▶ **To enter a space:** swipe right when the cursor is located in the input line.

- ▶ **To delete a character:** swipe left when the cursor is located in the input line.
  - ▶ **To confirm the entry:** press the touchpad.
  - ▶ **To finish character entry:** swipe upwards.
- or
- ▶ Press the  button.

#### Example: entering a destination (navigation)

- ▶ Enter the POI or address (→ page 247).

## System settings

### Display

#### Configuring display settings

Multimedia system:

↳ System ▶ ▶  Display and Designs

#### Styles

- ▶ Select **Designs**.
- ▶ Select **Sport**, **Classic** or **Progressive**.

#### Adapting the ambient lighting for the style

- ▶ Select **Adjust Amb. Lighting**.
- ▶ Activate  or deactivate  the function.

This function adjusts the ambient lighting for the selected display style.

#### Setting the display brightness

- ▶ Select **Display Brightness**.
- ▶ Select a brightness value.

#### Switching the display off/on

- ▶ **To switch off:** select **Display Off**.
- ▶ **To switch on:** press a button, for example 

#### Display design

- ▶ Select **Day/Night Design**.
- ▶ Select **Automatic**, **Day Design** or **Night Design**.

#### Additional display area

Depending on the vehicle, various items of additional information can be shown. The additional display area comprises the left-hand or right-hand third of the display.

- ▶ Select **Additional Disp. Area**.

The following display content can be selected:

- **Dynamic**
- **Navigation Map**
- **Consumption**
- **Time and Date**

### Time and date

#### Setting the time and date automatically

Multimedia system:

↳ System ▶ ▶  Time and Date

- ▶ Deactivate  **Manual Time Adjustment**.  
The time and date are set automatically for the selected time zone and summer time option.
- ⓘ The correct time is required for the following functions:

- Route guidance with time-dependent traffic guidance.
- Calculation of expected time of arrival.

### Setting the time zone

Multimedia system:

→ System →  Time and Date

→ Time Zone:

The list of countries is displayed.

- ▶ Select a country ●.  
Depending on the country, time zones are displayed.
- ▶ Select a time zone.  
The time zone set is displayed after **Time Zone:**.

### Setting summer time

The **Automatic Daylight Saving Time** and **Daylight Saving Time** options cannot be selected in all countries.

Multimedia system:

→ System →  Time and Date

### Automatically

- ▶ Switch **Automatic Daylight Saving Time** on  or off .

### Manually

- ▶ Deactivate  **Automatic Daylight Saving Time**.
- ▶ Select **Daylight Saving Time**.
- ▶ Select **On** or **Off**.

### Setting the time and date format

Multimedia system:

→ System →  Time and Date

→ Set Format

- ▶ Set the date and time format ●.

### Setting the time manually

#### Requirements:

- The **Manual Time Adjustment** function is switched on.

Multimedia system:

→ System →  Time and Date

→ Set Time

- ▶ Set the hours.
- ▶ Navigate to the right to set the minutes.
- ▶ Set the minutes.

- ▶ Confirm changes when exiting the menu.

The date is set automatically via GPS.

### Connectivity

#### Switching transmission of the vehicle position on/off

Multimedia system:

→ System →  Connectivity

- ▶ Select **Transmit Vehicle Pos..**
- ▶ Activate  or deactivate  the function.

### Bluetooth®

#### Information about Bluetooth®

Bluetooth® technology is a standard for short-range wireless data transfer up to approximately 32.8 ft (10 m).

You can use Bluetooth® to connect your mobile phone to the multimedia system and use the following functions, for example:

- Hands-free system with access to the following options:

- contacts (→ page 279)
- call lists (→ page 281)
- text message (→ page 281)
- Internet connection (→ page 295)
- Listening to music via Bluetooth® audio
- Transferring business cards (vCards) into the vehicle

Bluetooth® is a registered trademark of Bluetooth Special Interest Group (SIG) Inc.

-  Internet connection via Bluetooth® is not available in all countries.

### Activating/deactivating Bluetooth®

#### Requirements:

- Deactivate Bluetooth®: Apple CarPlay® is not active.

Multimedia system:

 System  Connectivity

-  Activate  or deactivate  Bluetooth®.

If Android Auto is active, a prompt appears asking whether Bluetooth® should be deactivated.

-  Select **Yes**.

Android Auto is closed and Bluetooth® is deactivated.

### Wi-Fi

#### Wi-Fi connection overview

You can use Wi-Fi to establish a connection with a Wi-Fi network and to access the Internet or other network devices.

The following connection options are available:

- Wi-Fi connection

The Wi-Fi connection to a Wi-Fi-capable device, e.g. the customer's mobile phone or a tablet PC is established.

- Multimedia system as a Wi-Fi hotspot

Using this function, a tablet PC or notebook can be connected, for example.

To establish a connection, you can use the following methods:

- WPS PIN

The connection to a secure Wi-Fi network is made via a PIN.

- WPS PBC

The connection to a secure Wi-Fi network is made by pressing a button (push button).

- Security key

The connection to a secure Wi-Fi network is made via a security key.

### Setting up Wi-Fi

#### Requirements:

- The device to be connected supports one of the three means of connection described (→ page 236).

Multimedia system:

 System  Connectivity

### Activating/deactivating Wi-Fi

-  Switch **Wi-Fi** on  or off .

If **Wi-Fi** is deactivated , communication via Wi-Fi to all devices is interrupted. This also means that a connection to the HERMES communication module cannot be established.



Then functions such as dynamic route guidance with Live Traffic Information are not available.

### Connecting the multimedia system with a device via Wi-Fi



This function is not available if a HERMES communication module is installed.



The type of connection established must be selected on the multimedia system and on the device to be connected.

 The connection procedure may differ depending on the device. Follow the instructions that are shown in the display. Further information (see the manufacturer's operating instructions).





-  Select **Internet Settings**.
-  Select **Search for Wi-Fi Networks**.

### Using a security key







-  Select a Wi-Fi network in the list.
-  Have the security key displayed on the device to be connected (see the manufacturer's operating instructions).

-  Enter this security key on the multimedia system.
-  Confirm the entry with **ok**.
-  All devices support a security key as a means of connection.

### Using a WPS PIN







-  Highlight a Wi-Fi network in the list.
-  Select  **Connect via WPS PIN Input**. The multimedia system generates an eight-digit PIN.
-  Enter this PIN on the device to be connected.
-  Confirm the entry.

### Using a button

-  This function is only available in a Wi-Fi frequency of 2.4 GHz.
-  Highlight a Wi-Fi network in the list.
-  Select  **Connect via WPS PBC**.
-  Select "Connect via WPS PBC" in the options on the device to be connected.
-  Press the WPS button on the device to be connected.

-  Select **Continue** in the multimedia system.

### Device has already been connected:

-  **To automatically connect:** highlight a Wi-Fi network in the list.
-  Activate  **Connect Automatically** .
-  **To connect:** highlight a Wi-Fi network in the list.
-  Select  **Connect**.  
The connection is established again. These functions are possible when the device has already been connected to the Wi-Fi network.

### Setting up a Wi-Fi hotspot

#### Requirements:

-  **For connection by pressing a button:** this function is only available in a Wi-Fi frequency of 2.4 GHz.

Multimedia system:

➔ System ➔  Connectivity

### Configuring the multimedia system as a Wi-Fi hotspot

The type of connection established depends on the device to be connected. The function must be supported by the multimedia system and by the device to be connected. The type of connection established must be selected on the multimedia system and on the device to be connected.

- ▶ Select **Set Up Hotspot**.
- ▶ Highlight **Connect Device to Vehicle Hotspot**.

### Generating a WPS PIN

- ▶ Select  **Connect via WPS PIN Generation**.
- ▶ Enter the PIN shown in the media display on the device to be connected and confirm.

### Connecting using a WPS PIN

- ▶ Select  **Connect via WPS PIN Input**.
- ▶ Select **Enter WPS PIN**.

- ▶ Enter the PIN that is shown on the external device's display on the multimedia system.
- ▶ Select **Continue**.

### Connecting using a button

- ▶ Select  **Connect via WPS PBC**.
- ▶ Press the WPS button on the device to be connected or select **Connect**.
- ▶ Select **Continue** in the multimedia system.

### Connecting using a security key

- ▶ Select **Connect Device to Vehicle Hotspot**. A security key is displayed.
- ▶ Select the vehicle from the device to be connected. The vehicle is displayed with the SSID **MB Hotspot XXXXX**.
- ▶ Enter the security key which is shown in the media display on the device to be connected.
- ▶ Confirm the entry.

### Connecting using NFC

- ▶ Select **Connection via NFC**.

- ▶ Activate NFC on the mobile device (see the manufacturer's operating instructions).
- ▶ Bring the mobile device into the NFC area of the vehicle (→ page 276).
- ▶ Select **Done**.  
The mobile device is now connected to the multimedia system hotspot via NFC.

### Generating a new security key:

- ▶ Select **Set Up Hotspot**.
- ▶ Select **Generate Security Key**.  
A connection will be established with the newly created security key.
- ▶ **To save a security key:** select **Save**.  
When a new security key is saved, all existing Wi-Fi connections are then disconnected. If the Wi-Fi connections are being re-established, the new security key must be entered.

### Managing COMAND Touch devices

#### Requirements:

- The COMAND Touch app is installed on the external device (e.g. tablet or smartphone).



- Wi-Fi is activated (→ page 236) and the multimedia system is configured as a Wi-Fi hotspot (→ page 237).

Multimedia system:

↳ System ▶ COMAND Touch

### Connecting and authorizing a new device

- ▶ Select **Authorize a New Device**.
- ▶ Select **Connect New Device**.
- ▶ Enter the security key in the external device. The **Please start COMAND Touch on your device and follow the instructions** message appears.
- ▶ Select **Continue**.
- ▶ The connection request from the device **Accept**.
- ▶ Enter the PIN shown on the external device. The device is authorized.

### Authorising a connected device

- ▶ Select **Authorize a New Device**. The devices already connected are displayed.

- ▶ Select **Continue Using Connected Devices**. The **Please start COMAND Touch on your device and follow the instructions** message appears.
- ▶ Select **Continue**.
- ▶ The connection request from the device **Accept**.
- ▶ Enter the PIN shown on the external device. The device is authorized.

### De-authorizing the device

- ▶ Select an authorized device from the list. A prompt will appear asking whether you would like to de-authorize the selected device.
- ▶ Select **Yes**. The device is de-authorized.

### Activating/deactivating child safety lock

Multimedia system:

↳ System ▶ Parental Control

### Locking or unlocking an external device

- ▶ Select an external device.

- ▶ Select **Lock**. The device connected via the COMAND Touch app is locked  or unlocked .

### System language

#### Notes on the system language

This function allows you to determine the language for the menu displays and the navigation announcements. The selected language affects the characters available for entry. The navigation announcements are not available in all languages. If a language is not available, the navigation announcements will be in English.

#### Setting the system language

Multimedia system:

↳ System ▶ Language

- ▶ Set the language.
- ① If you are using Arabic map data, the text information can also be shown in Arabic on the navigation map. To do so, select العربية as the language from the language list. Navigation announcements are then also made in Arabic.

## Setting the distance unit

Multimedia system:

↳ System ▶ Units

- ▶ Select **km** or **mi**.
- ▶ In the multifunction display of the Instrument Display, switch the **Additional Speedometer** display on .

## Data import and export

### Data import/export function

The following functions are possible:

- Transferring data from one system or vehicle to another system or vehicle.
  - Creating a backup copy of your personal data and loading it again.
  - Protecting your personal data against unwanted export with PIN protection.
- i** Note that the NTFS filing system is not supported. The FAT32 filing system is recommended.

### Importing/exporting data

**!** **NOTE** Loss of data due to premature removal

▶ Do not remove the data storage medium when data is being exported.

Mercedes-Benz is not liable for any loss of data.

### Requirements:

- The vehicle is stationary.
- The ignition is switched on or the vehicle has been started.
- The SD card is inserted (→ page 300) or the USB device is connected (→ page 302).

Multimedia system:

↳ System ▶ System Backup

▶ Select **Import Data** or **Export Data**.

### Importing

▶ Select a data storage medium. A prompt appears asking whether you really wish to overwrite the current data. If data orig-

inates from another vehicle, this is recognized during data reading.

The multimedia system is restarted once the data has been imported.

**i** Current vehicle settings can be edited after the import.

### Exporting

If PIN protection is activated, your PIN is requested.

- ▶ Enter the four-digit PIN.
- ▶ Select a data storage medium. The data is exported. The data export may take several minutes.

## Activating/deactivating PIN protection

### Requirements:

To unlock the PIN:

- There is an Internet connection.
- A Mercedes me account exists at <https://me.secure.mercedes-benz.com>.

- The **Personalization** service is active (→ page 242).

Multimedia system:

↳ **System** ▶ **PIN Protection**

### Setting the PIN

- ▶ Select **Set PIN**.
  - ▶ Enter a four-digit PIN.
  - ▶ Enter the four-digit PIN again.
- If both PINs match, PIN protection is active.

### Changing the PIN

- ▶ Select **Change Settings**.
- ▶ Enter the current PIN.
- ▶ Select **Change PIN**.
- ▶ Set a new PIN.

### Activating PIN protection for data export

- ▶ Select **Change Settings**.  
Confirm with the PIN.
- ▶ Select **Protect Data Export**.  
Activate  or deactivate  the function.

### Unblocking the PIN

If the PIN has been entered incorrectly three times, the PIN will be blocked. You can have a single-use password sent to you via the Mercedes me connect online portal to reset the PIN protection.

- ▶ Select **Unblock PIN**.
  - ▶ Enter the single-use password.  
PIN protection is reset, and you can set a new PIN.
- i** The availability of this function is country dependent and may not be available in your country.  
Alternatively, you can have PIN protection reset at an authorized Mercedes-Benz Center.

### User profile

#### Setting a user profile

Multimedia system:

↳ **System** ▶  **Personalization**

#### Displaying a user profile when starting

If this function is active, a prompt appears when starting the system asking which user profile to use.

- ▶ Select **Display Profile Selection after Start**.
- ▶ Activate  or deactivate  the function.

#### Selecting a user profile

- ▶ Select **Guest Profile** or individual profile ●.
- i** Some settings from the user profile are only loaded when the vehicle is stationary or when the ignition is switched on.

#### Automatic synchronization

Each time the ignition is switched off or on, the individual user profiles are synchronized on the multimedia system and on the server. This ensures that the latest user profiles are available.

- ▶ Select **Automatic Synchronization**.

- ▶ Activate  or deactivate  the function.
- ① For more information about importing/exporting user profiles (→ page 242).

### Creating a user profile

Multimedia system:

↳ System ▶ ▶  Personalization  
▶▶ Create Profile

- ▶ Enter a name.
- ▶ Select .

The following information is saved in the user profile, for example:

- System settings
- Navigation and traffic information

The settings differ depending on the vehicle equipment.

### Importing/exporting a user profile

#### Requirements:

- There is an Internet connection .
- A Mercedes me account exists at <https://me.secure.mercedes-benz.com>.

- The **Personalization** service is active.
- The function is available in your country.

Multimedia system:

↳ System ▶ ▶  Personalization  
▶▶ Manual Export/Import

### Importing a user profile

- ▶ Select **Import Profiles from Server**.  
The **The profile data import overwrites all existing profile data. Do you want to continue?** message appears.
- ▶ Select **Yes**.  
User profiles are imported.

### Exporting a user profile

- ▶ Select **Export Profiles to the Server**.  
User profiles are exported.
- ① Only individual profiles can be imported or exported. The individual profiles are always collectively imported or exported.
- ① Certain settings, such as address book entries or previous destinations from the navigation system, are not exported.

### Setting user profile options

Multimedia system:

↳ System ▶ ▶  Personalization

- ▶ Highlight a profile.
- ▶ Select  options.

The following options are available:

- **Rename**
  - **Delete**
  - **Reset**
- ① The guest profile cannot be deleted or renamed.

### Software updates

#### Information on software updates

The multimedia system displays a corresponding message when a software update is available. The availability of this function is dependent on the country.

Depending on the source, you can perform various updates:

Source of the update	Update type
Updates via mobile phone	Navigation map, system updates, Digital Operator's Manual
Updates via an external storage medium, e.g. a USB flash drive	Navigation maps

**i** Software updates via mobile phone require an active Internet connection for the vehicle. This is not available in all countries. For further information on connecting to the Internet, see (→ page 295).

#### Advantages of software updates

Software updates ensure your vehicle's technology is up-to-date.

In order to constantly improve the quality of our services you will receive future software updates for your multimedia system, the Mercedes me connect services and your vehicle's communication module. These will be sent to you via the

mobile phone connection in your vehicle and, as an option, installed automatically. You can monitor the status of your software updates on the Mercedes me Portal and find information about potential innovations.

Your advantages at a glance:

- Conveniently receive software updates via the mobile phone network
- Improves the quality and availability of Mercedes me connect services
- Keeps your multimedia system and communication module up-to-date

Further information about software updates can be found at <https://me.secure.mercedes-benz.com>

#### Carrying out software updates

##### Requirements:

- There is an Internet connection (→ page 295).
- **For automatic software updates:** your vehicle has a permanently installed communication module.

Multimedia system:

↳ System ▶ Software Update

#### Automatic software updates

- ▶ Activate  **Automatic Online Update.**  
The software updates will be downloaded and installed automatically.  
The current status of the software update is displayed.

#### Manual software updates

- ▶ Switch off  **Automatic Online Update.**
- ▶ Select a software update from the list and start the update.

#### Activating a software update

- ▶ Restart the system.

#### Function of important system updates

Important system updates may be necessary for the security of your multimedia system's data. Please install these updates, otherwise the security of your multimedia system cannot be ensured.

- ❶ If automatic online updates are activated, the system updates will be downloaded automatically (→ page 243).

As soon as a system update is available for download, a corresponding message appears on the media display.

You have the following selection options:

- **Download**  
The system update will be downloaded in the background.
- **Details**  
Information about the pending system update is displayed.
- **Later**  
The system update can be downloaded manually at a later time (→ page 243).

You will be informed when the download is complete and the system update is ready for installation.

- ❶ Park the vehicle safely in a suitable location before starting the installation.

Requirements for installation:

- The ignition is switched on.
- The engine is not running.
- Notes and warnings have been read and accepted.
- The parking brake is applied.

If all requirements are met, the system update is installed. The multimedia system cannot be operated during installation and vehicle functions are restricted.

If errors should occur during the installation, the multimedia system automatically attempts to restore the previous version. If restoration of the previous version is not possible, a symbol appears on the multimedia system display. Consult a qualified specialist workshop to resolve the problem.

## Reset function

**⚠ WARNING** Risk of accidents due to failure of multimedia display functions

While the multimedia system is being reset, its functions such as the rear view camera are not available.

- ▶ Only reset the multimedia system when the vehicle is stationary.

Multimedia system:

↶ System ▶▶ Reset

Personal data is deleted, for example:

- Station presets
- Connected mobile phones

▶ Select **Yes**.

If PIN protection is activated, a prompt appears asking if you also wish to restore this to the factory settings during a reset.

▶ Select **Yes**.

- ▶ Enter the current PIN.  
The PIN is reset.

or

- ▶ Select **No**.  
The current PIN stays the same after resetting.
- ⓘ If you have forgotten your PIN, an authorized Mercedes-Benz Center can deactivate the PIN protection for you.

A prompt appears again asking whether you really wish to reset.

- ▶ Select **Yes**.  
The multimedia system is reset to the factory settings.

## Fit & Healthy

### ENERGIZING COMFORT

#### Overview of the ENERGIZING COMFORT program

Program overview

- **Refresh:** Can make targeted changes to the interior climate to refresh vehicle occupants. The air is purified by the cooling air flow and

ionization.. The vehicle interior is illuminated with cool colors and the seat is ventilated.

- **Warmth:** Can increase the comfort level of the vehicle occupants. The vehicle's panel, seat and steering wheel heating provide cosy warmth. The air is purified using ionization and a pleasant fragrance is released. The vehicle interior is illuminated with warm lighting.
- **Vitality:** Can counteract diminishing attentiveness in monotonous driving situations. Fast-paced music and a vitalizing relaxation provide invigorating stimulation for the vehicle occupants. The air is purified using ionization and a pleasant fragrance is released. The vehicle interior is illuminated with a stimulating hue and the seat is ventilated.
- **Joy:** Can promote a positive mood in the vehicle occupants as well as mental and physical regeneration. Moderately fast music is played and a massage program is activated. The air is purified using ionization and a pleasant fragrance is released. The vehicle interior is illuminated with friendly lighting.

- **Well being:** Can aid the physical and mental relaxation of vehicle occupants. A back relaxation combined with local warmth provide relaxation. The air is purified using ionization and a pleasant fragrance is released. The audio player plays selections of calming music and the vehicle interior is illuminated with pleasant lighting.
- **Training:** Can counteract the onset of muscle tension, limbs falling asleep or stress with targeted relaxation or stimulation exercises. The exercises are demonstrated in short videos. The air is purified using ionization and a pleasant fragrance is released. The vehicle interior is illuminated with lighting appropriate to the exercise.
- ⓘ Please note that the programs available and the associated functions depend on your vehicle equipment. Depending on your equipment, fewer functions may be available.

#### Starting the ENERGIZING Comfort program

##### Requirements

- The ignition is switched on.

- ENERGIZING Comfort is available approximately five minutes after starting the multimedia system.

Multimedia system:

→ Vehicle → ENERGIZING Comfort

#### Selecting a seat

- Select **Seat Selection**.
- Select the desired seat or **All Seats** .

#### Starting a program

- Select **Refresh, Warmth, Vitality, Enjoyment** or **Well-being**.

The selected program will run for ten minutes.

#### Configuring a program

- Call up further options  for the desired program.
- Switch the functions included in the program on  or off .

#### Starting training

- Select **Training**.

- Select **Muscle Relaxation, Muscle Stimulation** or **Balance**.

The selected training video starts and is displayed in the media display.

- Select **Full Screen: Video**.

The training video is displayed in full screen.

- For more information on pausing or skipping through videos, see (→ page 303).

If, during an active program, a function requirement is no longer met, a corresponding message appears. The active program is canceled.

#### Navigation

##### Switching navigation on

Multimedia system:

→ Navigation

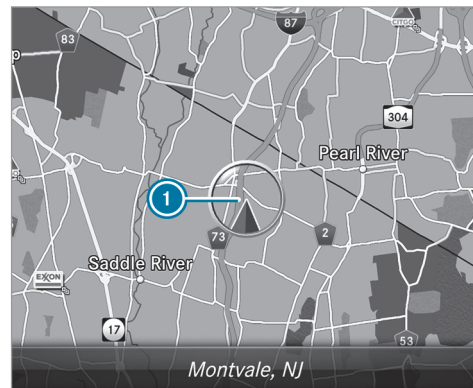

- Alternatively: press the **NAVI** button. The map appears and shows current vehicle position .



- ❗ If a climate control setting is changed, a climate bar appears briefly.

### Showing or hiding the navigation menu

#### Requirements

- The map displays the current vehicle position.

Multimedia system:

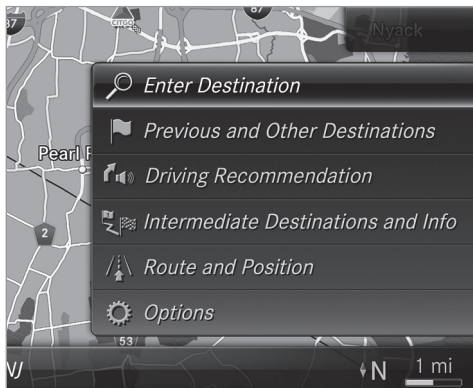

- ▶ **To show:** swipe left on the touchpad or the Touch Control.

or

- ▶ Slide the controller to the left.

- ▶ **To hide:** swipe right on the touchpad or the Touch Control.

or

- ▶ Slide the controller to the right.

- ❗ To show or hide lower menu levels, swipe or slide to the left or right as many times as necessary.

### Destination entry

#### Entering a POI or address

- ⚠ **WARNING** Risk of distraction from information systems and communications equipment

If you operate information systems and communication devices integrated in the vehicle when driving, you could be distracted from the traffic situation. This could also cause you to lose control of the vehicle.

- ▶ Only operate this equipment when the traffic situation permits.
- ▶ If you cannot be sure of this, stop the vehicle whilst paying attention to road and traffic conditions and operate the equipment with the vehicle stationary.

Observe the legal requirements for the country in which you are currently driving when operating the multimedia system.

#### Requirements

- ▶ **For the online search:** Mercedes me connect is available.
- ▶ You have a user account for the Mercedes me Portal.
- ▶ The service is available.
- ▶ The service has been activated at an authorized Mercedes-Benz Center.

Further information is available at: <https://www.mercedes.me>

Multimedia system:

### Navigation

- ▶ Show the navigation menu.
- ▶ Select  Enter Destination .

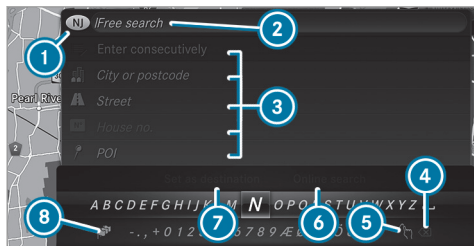

The state or province in which the vehicle is located is set ①.

There are two available methods of destination entry:

- Free search ②
- Search step-by-step ③

### Method 1: free search

- ▶ Enter the POI or address in ②. The entries can be made in any order. During destination entry, suggestions are made by the multimedia system. A selection of destinations appears in a list.

Enter these address elements, for example:

- City, street, house number
- Street, city
- Zip code
- POI name
- POI category, e.g. [Gas Station](#)
- City, POI name

- ▶ **To switch to handwriting recognition:** select  ⑤.

- ▶ Write the character on the touchpad.

- ▶ **To switch to character selection:** press the  button.

or

- ▶ Press the touchpad.

- ▶ **To delete an entry:** select  ④ (if available).

Use the following options:

- Press briefly: deletes the last character entered or the last suggestion adopted.
- Press and hold: deletes the entire entry.

- ▶ **To set the language:** select  ⑧.

- ▶ Select the language.

① This function is useful for countries in which several character sets are supported. An example is Russia, which uses Cyrillic and Latin characters.

- ▶ **To call up the online search function:** select [Online Search](#) ⑥.

Once an Internet connection is established, a list appears. It shows online destinations related to the previous entry.

The online destination is supplied by an Internet provider.

- ▶ Select the online destination.

or

- ▶ Enter the online destination or a 3 word address in the input line.
- ① Enter a 3 word address (→ page 252).  
Online search is not available in all countries.

▶ **To call up the list:** press the  button.

or

- ▶ If the top line of the character bar is highlighted, navigate upwards.
- ▶ Select the destination in the list.
- ▶ **To adopt a destination:** select  **Select Destination** .  
If there are several listings for a destination, a list appears.
- ▶ Select the destination.  
The destination address is shown.

### Method 2: search step-by-step

▶ Press the  button.

or

- ▶ If the top line of the character bar is highlighted, navigate upwards.  
The character bar is hidden. **City or ZIP** is highlighted. Additional entry fields are available, e.g. for **POI**.
- ▶ Select **City or ZIP**.  
The character bar appears.
- ▶ Enter the city or the zip code.  
During destination entry, suggestions are made by the multimedia system. A selection of destinations appears in a list.  
The address entries can be made in any order, for example:
  - **City or ZIP, Street, House No.**  
Enter an intersecting street, if available.
  - **Street, City or ZIP**
  - **POI, e.g. Gas Station, City or ZIP**
- ① During destination entry, use the following functions:
  - Switch to handwriting recognition.
  - Switch to character selection.
  - Delete an entry.

An entry, e.g. **POI**, can be deleted with  in a step-by-step search. Navigate to the left to do so.

- Call up the online search function (if available).
- Call up a list.

The functions are described in the free search.

- ▶ **To change the state/province:** select the state or the province.
- ▶ Enter the state or the province. You only need to enter the first character.
- ▶ Select the state or the province in the list.
- ▶ **To change the country:** select the country.
- ▶ Enter the country. You only need to enter the first character.
- ▶ Select the country on the list.
- ▶ **To adopt a destination:** select **Select Destination**.  
If there are several listings for a destination, a distance-orientated list appears.

- ▶ Select the destination.  
The destination address is shown.

### Selecting previous destinations

Multimedia system:

#### Navigation

#### ▶ Previous and Other Destinations

- ▶ Select **Previous Destinations**.
- ▶ Select the destination.  
The destination address is shown.

or

- ▶ If favorites have been saved already (→ page 262), select **From My Favorites**.
- ▶ Select the favorite.  
The destination address is shown.

### Selecting a POI

Multimedia system:

#### Navigation

#### ▶ Previous and Other Destinations

#### ▶ POIs

- ▶ Select the category.

or

- ▶ Select **All Categories** and the category.  
**If route guidance is not active:** the search begins in the vicinity of the current vehicle position. The list is sorted by distance in ascending order.

The POIs show the following information:

- Name of POI
- Linear distance to the POI
- The direction of the linear distance to the POI (arrow) is displayed when searching for the vehicle's current position.

- ▶ Select the POI.
- ▶ **Route guidance is active:** select the search position prior to choosing a POI (see example).
- ▶ If intermediate destinations are set, these can also be selected as the search position after selecting **Near Destination**.

### Filtering displays for POIs

- ▶ Enter the search term in  **Search:**.  
The results list shows relevant POIs.
- ▶ Select  **ok**.  
The first POI in the list is highlighted.

- ▶ Select the POI.

### Example: setting the search position for the parking category during active route guidance

- ▶ Select **In the Vicinity, Near Destination** or **Along the Route**.  
The list shows the located POIs or opens an overview of the route destination after selecting **Near Destination**.
- ▶ Select the POI.
- ▶ Select **Near Destination**: select the intermediate destination or the destination.

### Starting an automatic gas station search

#### Requirements:

- The automatic gas station search is activated  
 (→ page 256).

#### Driving situation

Route guidance is active. The fuel level in the fuel tank reaches the reserve fuel level.

The **Reserve Fuel Do you want to start a search for surrounding gas stations?** message is shown.

- ▶ Select **Yes**.  
The automatic gas station search begins. The available gas stations along the route or in the vicinity of the vehicle's current position are displayed.
- ▶ Select the gas station.  
The address of the gas station is displayed.
- ▶ If route guidance is not active, select **Start Route Guidance**.  
The selected gas station is set as the destination. Route guidance begins.

or

- ▶ If route guidance is active, select **Start New Route Guidance** or **Set as Next Way Point**.  
**Start New Route Guidance:** the selected gas station is set as a new destination. The previous destinations and intermediate destinations are deleted. Route guidance to the gas station begins.  
**Set as Next Way Point:** the selected gas station is set as the next intermediate destination. Route guidance begins.

- ▶ **If there are already four intermediate destinations:** select **Yes** in the prompt.  
The selected gas station is entered into position 1 of the intermediate destinations menu. Intermediate destination 4 is deleted. Route guidance begins.

### Entering an intermediate destination

#### Requirements

- A destination is entered.

Multimedia system:

↳ **Navigation** ▶ **Way Points and Info**

- ▶ Select **Search for Way Point**.
- ▶ Enter the intermediate destination as a POI or address (→ page 247).
- ▶ Select the intermediate destination.
- ▶ Select **Set as Destination**.

or

- ▶ Select an intermediate destination using  **Enter Destination** during route guidance.
- ▶ Select **Set as Next Way Point** after entering the destination.



### Editing intermediate destinations

#### Requirements

- The destination and at least one intermediate destination have been entered.

Multimedia system:

↳ **Navigation** ▶ **Way Points and Info**

- ▶ **To call up the map:** highlight the destination or the intermediate destination.
- ▶ Select  **Map**.
- ▶ Move the map (→ page 267).
- ▶ Select destination on the map (→ page 253).
- ▶ **To change the order of destinations:** highlight the destination or the intermediate destination.
- ▶ Select  **Move**.
- ▶ Move the intermediate destination to the desired position.
- ▶ Press the Touch Control, the controller or the touchpad.
- ▶ **To delete a destination:** highlight the destination or the intermediate destination.

- ▶ Select  **Delete**.

### Calculating a route with intermediate destinations

#### Requirements:

- The destination and at least one intermediate destination have been entered.

Multimedia system:

- ▶  **Navigation** ▶ **Way Points and Info**



- ▶ Select **Start New Route Guidance**.  
The route is calculated with the set intermediate destinations.

### Selecting a contact for destination entry

#### Requirements:

- A mobile phone is connected to the multimedia system (→ page 274).
- The "Navigate to contact" online service is available and activated.

Multimedia system:

- ▶  **Navigation**
- ▶▶  **Previous and Other Destinations**
- ▶▶ **Contacts**



- ▶ Select the contact.  
The contact details are displayed.
- ▶ Select the address.  
The **Please Wait...** message appears. The search is carried out online.
- ▶ Select the destination.

### Filtering displays for contacts

- ▶ Enter a name or telephone number, for example, into the search field.
- ▶ Select .
- ▶ Select the contact.  
The first contact in the list is highlighted.
- ▶ Select the address.

### Entering geo-coordinates

Multimedia system:

- ▶  **Navigation**
- ▶▶  **Previous and Other Destinations**
- ▶▶ **Geo-coordinates**

- ▶ Enter geo-coordinates as latitude and longitude coordinates in degrees, minutes and seconds.  
The map shows the position.
- ▶ Confirm the entry.
- ▶ **To calculate a route:** select **Start Route Guidance**.
- ▶ If a route has already been created, select **Start New Route Guidance** or **Set as Way Point**.

### Entering the destination as a 3 word address

#### Requirements:

- Searching for a destination using 3 word addresses is possible in the online search (→ page 247).
- There is an Internet connection.

- ❗ Searching for a destination using 3 word addresses is not possible in all countries.

Multimedia system:

Navigation  Enter Destination

- ▶ Select **Online Search**.
- ▶ Enter the destination address as a 3 word address. Separate each of the words with a full stop.  
The search results are displayed.
- ▶ Select the destination in the list.  
The destination address is shown. The route can be calculated.

- ❗ 3 word addresses from what3words are an alternative addressing system for multilingual georeferencing of global locations with a resolution of three meters. Using this grid, locations on the Earth's surface are included which do not have a building address such as a street and house number, for example. The Empire State Building has this language dependent 3 word address:

- English: **parade.help.bleat**
- French: **commun.verbe.bisquer**

- Spanish: **suertes.diga.pesca**

3 word addresses are unique, easy to remember and suffice for most routine applications.

You can convert addresses to 3 word addresses and back again:

- At the website <https://what3words.com>
- In the what3words apps

### Selecting a destination on the map

Multimedia system:

Navigation  Options

- ▶ Select **Map Menu**.
- or
- ▶ If the map is displayed in full screen mode, press the central control element.  
The map menu appears.
- ▶ Select "move map" in map menu  (→ page 265).
- ▶ Swipe in any direction on the Touch Control or touchpad.
- or

- ▶ Slide the controller in any direction.  
The map moves in the corresponding direction under the crosshair. The more you move your finger away from the starting position on the touchpad, the faster the map moves.
- ▶ Press the Touch Control, the controller or the touchpad.  
If several destinations are located around the crosshair, a list shows the available POIs and roads.  
If a destination is located exactly on the crosshair, the destination address is displayed.
- ▶ Select the destination in the list.  
The destination address is shown.

### Setting the map orientation to 2D or 3D

- ▶ Highlight **Map Orientation: 2D/3D**.
- ▶ Press the Touch Control, the touchpad or the controller.  
The map will be displayed in the selected map orientation.

### Showing traffic messages in the vicinity of the map

- ▶ Select **Traffic Messages for the Vicinity**.  
The map appears.
- ▶ Swipe left or right on the touchpad.

or

- ▶ Slide the controller to the left or right.  
The previous or next traffic incident is highlighted on the map. Information on the traffic incident is displayed.

① Traffic reports are not available in all countries.

### Showing POIs in the vicinity of the map

- ▶ Select **POIs in the Vicinity**.
- ▶ Swipe left or right on the touchpad.

or

- ▶ Slide the controller to the left or right.  
The previous or next POI is highlighted on the map. The name or the address is shown.
- ▶ **To filter the display by POI category:** swipe down on the Touch Control or the touchpad.

or

- ▶ Slide the controller down.
- ▶ Select the POI category.

① **User Defined** allows personal POI symbols to be selected (→ page 267).

## Route

### Calculating a route

#### Requirements:

- The destination has been entered.
- The destination address is shown.

- ▶ If route guidance is not active, select **Start Route Guidance**.  
The route to the destination is calculated. The map shows the route. Route guidance then begins.

or

- ▶ If route guidance is active, select **Start New Route Guidance** or **Set as Next Way Point**.  
**Start New Route Guidance:** the selected destination address is set as a new destination. The previous destinations and intermediate





destinations are deleted. Route guidance to the new destination begins.

**Set as Next Way Point:** the selected destination address is set as the next intermediate destination. Route guidance begins.

### Taking alternative routes into consideration

- ▶ Select an alternative route (→ page 256).

### Other menu functions

- ▶ **To save the destination:** select  **Store in "Previous Destinations"**.
- ▶ **To display on the map:** select  **Map**.
- ▶ **To call a telephone number:** select  **Call** (if available).
- ▶ **To call up an Internet address:** select  **www** (if available).

### Selecting a route type

Multimedia system:

- ▶  **Navigation** ▶▶  **Route and Position**
- ▶ Select **Route Settings**.



- ▶ Select the route type.  
If route guidance is active, the new route is calculated with the new route type.  
If route guidance is not active, the next route is calculated with the new route type.

You can choose from the following route types:

- **Eco Route**  
An economical route is calculated. The journey time may be somewhat longer than for quicker routes.  
The symbol for the current vehicle position is displayed in green.
- **Fast Route**  
A route with a quick journey time is calculated.
- **Short Route**  
A route with a short driving distance is calculated.

**Automatic Traffic Jam Avoidance** can be switched on  or off  for these route types. If **Automatic Traffic Jam Avoidance** is switched on,

**Ask in the Event of Traffic Jam Avoidance** can be selected.

The **Automatic Traffic Jam Avoidance** and **Ask in the Event of Traffic Jam Avoidance** settings are not available in every country.

The settings enable the following:

- **Automatic Traffic Jam Avoidance**  
The route is calculated with the currently set route type.  
Traffic reports via Live Traffic Information are taken into account.  
Live Traffic Information is not available in all countries.
- **Ask in the Event of Traffic Jam Avoidance**  
A prompt appears when a new route is detected with a shorter journey time based on traffic reports. You can continue to use the current route or use the dynamic route instead.

### Selecting route options

Multimedia system:

- ▶  **Navigation** ▶▶  **Route and Position**
- ▶▶ **Avoid Options**

### Avoiding areas

- ▶ Select **Areas** (→ page 268).

### Avoiding highways, ferries, motorail trains, tunnels, unpaved roads

- ▶ Select  or deselect  avoid option.

### Using toll roads

- ▶ Select **Use Toll Roads**.
- ▶ Select **Cash** or **Electronic Billing** or **Off**.  
The route takes into account roads that require the payment of a usage fee (toll).  
If **Off** is selected, toll roads are not taken into account.

The selected route options cannot always be implemented. Therefore, a route may include a ferry, for instance, even though the avoid **Ferries** option is enabled. A message appears and you will hear a corresponding message.

### Using carpool lanes

- ▶ Select **Number of Occupants in the Vehicle**.
- ▶ Select number.  
When using carpool lanes, observe the applicable legal requirements as well as any conditions pertaining to when and where such lanes may be used. Carpool lanes may only be used if certain conditions are met.

These route options are not available in every country.

### Selecting notifications for the route

Multimedia system:

- ↳ **Navigation** ▶  **Options**
- ↳ **Announcements**

- ▶ Switch an announcement on  or off .

You can choose from the following announcements:

- **Announce Traffic Warnings**  
This function is not available in all countries.
- **Announce Street Names**

The multimedia system announces the names of the roads that will follow the upcoming change of direction.

This function is not available in all countries and languages.

### Displaying destination information

#### Requirements:

- A destination is entered.

Multimedia system:

- ↳ **Navigation**

- ▶ Select **Way Points and Info**.

The following information is displayed:

- Intermediate destinations and destination  
The route can also include up to four intermediate destinations.
- Name, address
- Remaining driving distance
- Time of arrival

### Selecting an alternative route

Multimedia system:

- ↳ **Navigation** ▶  **Route and Position**

- ▶ Select **Alternative Route**.  
The routes are displayed in accordance with the setting made in the route settings.  
The currently selected route is shown with a dark blue line.
- ▶ Select the alternative route.

### Switching the automatic gas station search on or off

Multimedia system:

- ↳ **Navigation** ▶  **Options**

- ▶ Switch **Reserve Fuel** on  or off .  
Switched on : when the fuel reserve level is reached, a prompt appears asking whether you want to start searching for gas stations.

### Using automatic gas station search

#### Requirements:

The automatic gas station search is activated  (→ page 256).

The prompt **Reserve Fuel Do you want to start a search for surrounding gas stations?** appears.

- ▶ Select **Yes**.  
The automatic gas station search begins. The available gas stations along the route or in the vicinity are displayed.
- ▶ Select the gas station.
- ▶ When there is no route, the gas station is set as the destination.

or

- ▶ When there is a route, the gas station is set as the next intermediate destination.

### Starting the automatic service station search

#### Requirements

- ATTENTION ASSIST and the **Suggest Rest Area** function are activated (→ page 162).

#### Driving situation

The **ATTENTION ASSIST Do you want to search for a rest area?** message is shown.

- ▶ Select **Yes**.  
The service station search starts. The available service stations along the route or in the

vicinity of the vehicle's current position are displayed.

- ▶ Select the service station.  
The service station address is displayed.
- ▶ If route guidance is not active, select **Start Route Guidance**.  
The selected service station is set as a destination. Route guidance begins.

or

- ▶ If route guidance is active, select **Start New Route Guidance** or **Set as Next Way Point**.  
**Start New Route Guidance:** The selected service station is set as a new destination. The previous destination and all intermediate destinations are deleted. Route guidance to the service station begins.  
**Set as Next Way Point:** The selected service station is set as the next intermediate destination. Route guidance begins.

## Route guidance

### Notes on route guidance

**⚠ WARNING** Risk of distraction from operating integrated communication equipment while the vehicle is in motion

If you operate communication equipment integrated in the vehicle when driving, you could be distracted from the traffic situation. This could also cause you to lose control of the vehicle.

- ▶ Only operate this equipment when the traffic situation permits.
- ▶ If you cannot be sure of this, stop the vehicle whilst paying attention to road and traffic conditions and operate the equipment with the vehicle stationary.

You must observe the legal requirements for the country in which you are currently driving when operating the multimedia system. Route guidance begins once a route has been calculated.

The road and traffic rules and regulations always have priority over multimedia system driving instructions.

The following driving instructions can be used:

- Navigation announcements
- Route guidance displays
- Lane recommendations

If you do not follow the driving instructions or if you leave the calculated route, a new route is calculated automatically.

Driving instructions may differ from the actual road and traffic conditions if:

- The route is diverted
- The direction of a one-way street has been changed

For this reason, you must always observe road and traffic rules and regulations during your journey as well as the prevailing traffic conditions.

The route may differ from the ideal route due to the following:

- Roadworks

- Incomplete digital map data

#### Notes on GPS reception

The correct function of the navigation system depends amongst other things on GPS reception. In certain situations GPS reception can be impaired, defective or even not possible, e.g. in tunnels or in parking garages.

#### Changing direction overview

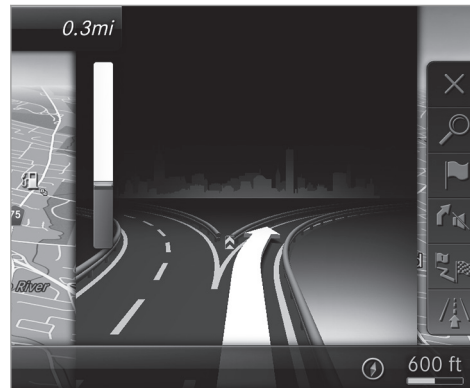

There are three phases when changing direction:

- Preparation phase

If there is enough time between the changes of direction, the multimedia system prepares you for the upcoming change of direction. A navigation announcement is issued, e.g. "Prepare to turn right".

The map appears in full-screen mode.

- Announcement phase

The multimedia system announces the upcoming change of direction, e.g. by announcing "Turn right in 300 ft (100 m)".

The display is split into two parts. The map is displayed on the left; on the right, there is a detailed image of the intersection or a 3D image of the upcoming change of direction.

- Change-of-direction phase

The multimedia system announces the imminent change of direction, e.g. by announcing "Now turn right".

The display is split into two parts.

The vehicle has successfully changed direction when the light-color bar on the right drops

down to 0 feet (0 m) and the current vehicle position symbol has reached the highlighted change-of-direction point.

When the change of direction is complete, the map appears in full-screen mode.

- Changes of direction are also shown in the Instrument Display.

#### Lane recommendations overview

This display appears for multi-lane roads.

If the digital map contains the relevant data, the multimedia system can display lane recommendations for the next two changes of direction.

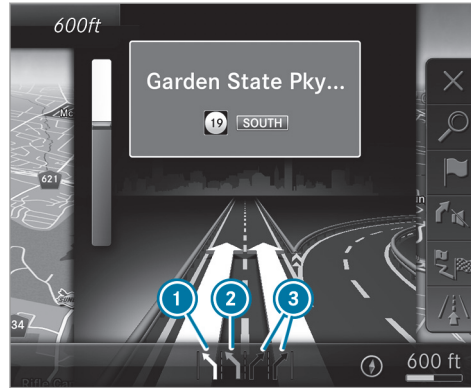

- 1 Recommended lane
- 2 Possible lane
- 3 Lanes not recommended

The following lanes are displayed:

- Recommended lane 1  
In this lane, you will be able to complete both the next change of direction and the one after that.

- Possible lane 2

In this lane, you will only be able to complete the next change of direction.

- Lane not recommended 3

In this lane, you will not be able to complete the next change of direction without changing lane.

During the change of direction, new lanes may be added.

- Lane recommendations can also be displayed in the Instrument Display and in the Head-up Display.

#### Overview of destination reached

Once the destination is reached, you will see the  checked flag. Route guidance will now be complete.

When an intermediate destination has been reached, you will see the intermediate destination flag with the number of your  intermediate destination. After this, route guidance will continue.

### Switching navigation announcements on or off

#### Requirements:



- Route guidance is active.

▶ **To switch off:** press the volume control on the multifunction steering wheel during a navigation announcement (→ page 230).

or

▶ Press the volume control on the center console during a navigation announcement (→ page 230).  
The **Voice Guidance has been deactivated.** message appears.

or

▶ Show the navigation menu (→ page 247).  
▶ Select  **Voice Guidance.**  
The symbol changes to .  
▶ **To activate:** select  **Voice Guidance.**  
The current navigation announcement is played.

❗ In the following situations, navigation announcements are switched on automatically:

- A new route guidance is started.
- The route is recalculated.

❗ You can add and call up this function as a favorite under **Voice Guidance On/Off.**

### Switching navigation announcements on or off during a phone call

- ▶ Select **System.**
- ▶ Select  **Audio.**
- ▶ Select **Navigation and Traffic Announcements.**
- ▶ Switch **Voice Guidance During Call** on  or off .

### Adjusting the volume of navigation announcements

#### Requirements:

- Route guidance is active.
- ▶ **On the multifunction steering wheel or on the multimedia system:** turn the volume control on

the multifunction steering wheel during a navigation announcement.

or

▶ Turn the volume control on the center console during a navigation announcement (→ page 231).

❗ In the following situations, the volume is raised to the maximum volume or lowered to the minimum volume:

- A new route guidance is started.
- The route is recalculated.

❗ The minimum volume can be individually set at an authorized Mercedes-Benz Center.

- ▶ **Via system settings:** select **System.**
- ▶ Select  **Audio.**
- ▶ Select **Navigation and Traffic Announcements.**
- ▶ Select **Voice Guidance Volume.**
- ▶ Set the volume.
- ▶ **To switch audio fadeout on/off during navigation announcements:** select **System.**

- ▶ Select  **Audio**.
- ▶ Select **Navigation and Traffic Announcements**.
- ▶ Switch **Audio Fadeout During Voice Guidance** on  or off .



### Repeating navigation announcements

#### Requirements

- A route has already been created.
- Route guidance is active.

Multimedia system:

↳ **Navigation**

- ▶ Select  **Voice Guidance**.
- ▶ Select  **Voice Guidance**.  
The current navigation announcement is repeated.

 You can add and call up this function as a favorite under **Repeat Voice Guidance**.

### Canceling route guidance

#### Requirements:

- A route has already been created.

- Route guidance is active.

Multimedia system:

↳ **Navigation**

- ▶ Select  **Cancel Route Guidance**.

### Overview of route guidance to an off-road destination

An off-road destination is within the digital map. The map contains no roads that lead to the destination.

You can enter geo-coordinates or a three word address for off-road destinations on the map. Route guidance guides you for as long as possible with navigation announcements and displays on roads that are known to the multimedia system.

Shortly before you reach the last known position on the map, you will hear the "Please follow the direction arrow" announcement. The display shows a direction arrow and the linear distance to the destination.

### Overview of route guidance from an off-road location to a destination

Off-road position: the current vehicle position is located within the digital map on roads that are not available.

When route guidance begins the following displays appear:

- The **Road Not Mapped** message is shown.
- A direction arrow showing the linear direction to the POI.

When the vehicle is back on a road known to the multimedia system, route guidance continues as normal.

### Overview of off-road status during route guidance

Due to roadworks, for example, there may be differences between the data on the digital map and the actual course of the road. In such cases, the multimedia system will temporarily be unable to locate the vehicle's current position on the digital map. The vehicle is off-road.

If the vehicle is displayed as being offroad, the following displays appear:

- The **Road Not Mapped** message

- A direction arrow showing the linear direction to the POI

When the vehicle is back on a road known to the multimedia system, route guidance continues as normal.

## Destination

### Saving the current vehicle position

Multimedia system:

#### Navigation

- ▶ If the map is displayed in full screen mode, press the central control element. The map menu appears.
- ▶ Select ① on the map menu (→ page 265). The current vehicle position is saved to the "Previous destinations" memory.

### Storing a map position

Multimedia system:

#### Navigation



The map is in full-screen mode.





- ▶ Press the Touch Control, the controller or the touchpad.
- ▶ Select "move map" in map menu ② (→ page 265).
- ▶ Select a position on the map. If multiple entries are available for a map position, a list appears.
- ▶ Highlight an entry.
- ▶ Select  Store in "Previous Destinations" . The map position is saved to the "Previous destinations" memory.

### Managing the previous destinations

Multimedia system:

#### Navigation

- ▶▶  Previous and Other Destinations
- ▶▶ Previous Destinations
- ▶ Highlight one of the previous destinations.
- ▶ To save as a favorite: select  Save My Favorite . The favorites are displayed.

- ▶ Move the favorite to the desired position. If a favorite has already been added at this position, it will be overwritten.
- ▶ To save as "Home" address: select  Save as "Home" .
- ▶ To save as "Work" address: select  Save as "Work" .
- ▶ To delete a single or all destinations: select  Delete or Delete All. A prompt appears.
- ▶ Select Yes.
- ▶ To display destination information: select  Details.

### Using external destinations

External destinations can be received from the following sources:

- Mercedes-Benz Apps
  - Door-to-door navigation with Companion app (USA)
- ① Received destinations are saved in the previous destinations.



A prompt appears on the media display.

- ▶ **A destination has been received without picture information:** select **Yes**.
- ▶ If route guidance is not active, select **Start Route Guidance**.  
The route to the destination is calculated. The map shows the route. Route guidance then begins.

or

- ▶ If route guidance is active, select **Start New Route Guidance** or **Set as Next Way Point**.  
**Start New Route Guidance:** the received destination address is set as a new destination. The previous destinations and intermediate destinations are deleted. Route guidance to the new destination begins.

**Set as Next Way Point:** the received destination address is set as the next intermediate destination. Route guidance begins.

- ▶ **A destination has been received with picture information:** select **Start Route Guidance**.  
Route guidance starts.

## Route guidance with current traffic reports

### Traffic information overview

Traffic reports are received using Live Traffic Information and are used for route guidance.

This service is unavailable in some countries.

There may be differences between the traffic reports received and the actual road and traffic conditions.

Important information on Live Traffic Information:

- Current traffic reports are received via the Internet connection.
- The traffic situation is updated at short, regular intervals.
- The subscription information shows the status (→ page 263).

Information on the vehicle's position is regularly sent to Mercedes-Benz AG. The data is immediately rendered anonymous by Mercedes-Benz AG and forwarded to the traffic data provider. Using this data, traffic reports relevant to the vehicle's position are sent to the vehicle. The vehicle acts as a sensor for the flow of traffic and helps to improve the quality of the traffic reports.

If you do not wish to transmit your vehicle position, you can have this service deactivated at an authorized Mercedes-Benz Center.

### Displaying subscription information

#### Requirements:

- The vehicle is equipped with Live Traffic Information.

Multimedia system:

Navigation ▶ Options

The subscription expiration date is automatically displayed:

- one month before the expiration date.
- one week before the expiration date.
- on the expiration date.

- ▶ **To display manually:** select **Live Traffic Subscription Info**.

Depending on the status, one of the following messages appears:

- the period of validity for the subscription is displayed.
- the subscription has expired.

- ① The subscription can be extended:
  - At an authorized Mercedes-Benz Center
  - Via an MB Info call to the Mercedes-Benz Customer Assistance Center

### Displaying the traffic map

#### Requirements

- For Live Traffic Information: the vehicle is equipped with a communication module featuring an activated, integrated SIM card.
- When the vehicle is started, the communication module automatically establishes an Internet connection. Traffic information is made available shortly afterwards.

Multimedia system:

→ Navigation →  Options  
 → Map Menu

- ▶ Alternatively: if the map is displayed in full screen mode, press the Touch Control, the controller or the touchpad. The map menu appears.
- ▶ Activate  .

The traffic map shows the following information, for example:

- Traffic incidents, for example:
  - Roadworks
  - Road blocks
  - Warning messages

The symbols for traffic incidents are displayed in color (on the route) or gray (off the route).

- Traffic flow information:
  - Traffic jam (red line)
  - Slow-moving traffic (orange line)
  - Heavy traffic (yellow line)
  - Free-flowing traffic (green line)
- Display for traffic delays on the route lasting at least one minute
- Warning message symbols:
  - Symbol 
  - Additional road safety notes when approaching a traffic incident, e.g. the end of a traffic jam

If the vehicle approaches a danger area on the route, a warning message is displayed on the map. A warning message may also be issued (→ page 265).

### Displaying traffic incidents

Multimedia system:

→ Navigation →  Options  
 → Map Content

- ▶ Activate **Traffic Incidents** .  
Roadworks, road blocks, local area reports (e.g. fog) and warning messages are displayed.

### Activating free flow and traffic display

- ▶ Activate **Free Flowing Traffic** and **Traffic Delays** .

- ① The traffic delay is displayed for the current route. Traffic delays lasting one minute or longer are taken into consideration.

### Displaying details

- ▶ Displaying the traffic map (→ page 264).
- ▶ Moving the map (→ page 267).

- ▶ When a traffic report symbol is under the crosshair, press on the central control element. The traffic report details are displayed.

or

- ▶ Press on the central control element.
- ▶ Select **Information on Traffic Reports**. The map shows the traffic report symbols in the vicinity. Traffic report information is displayed in the status line:
  - Traffic report symbol
  - Reason for the traffic report, e.g. traffic congestion
  - Warning message (highlighted in red)
- ▶ **To select a traffic report symbol:** select **Next** or **Previous**.
- ▶ Press on the central control element. The traffic report details are displayed.

### Issuing hazard warnings

Multimedia system:

- ▶ **Navigation** ▶  **Options**
- ▶ **Announcements**

- ▶ Activate  **Announce Traffic Warnings**. Warning messages are issued and tailbacks which pose a risk are announced.

### Map and compass

#### Map and compass overview

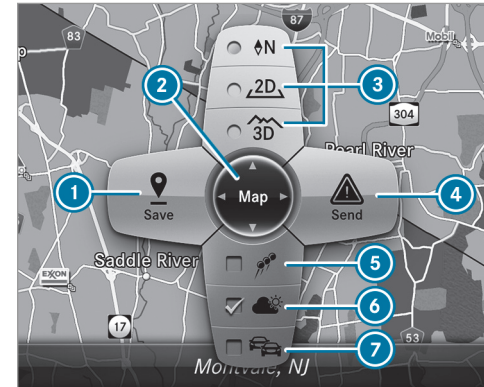

- ① Saves the current vehicle position
- ② Moves the map
- ③ Selects the map orientation and map view
- ④ Selects the function depending on the equipment:
  - Sends a hazard warning via Car-to-X.

- Filters the display of POIs in the vicinity according to POI category
- ⑤ Switches the display of personal POI symbols on the map on or off
- ⑥ Switches one of the following displays on or off depending on the equipment:
  - Weather information
  - Satellite map
  - Traffic incidents
- ⑦ Switches the traffic map display on or off

The map and satellite images are shown in globe projection. This allows for a realistic map display in all map scales. The map uses elevation modeling.

Depending on the map data, important buildings in many cities are depicted realistically on the map in small map scales (e.g. 1/32 mi (20 m), 1/16 mi (50 m)). Other buildings are shown as models.

- ① You can set the unit of measurement of the map scale (→ page 240).

If available, online information is displayed, e.g. parking garage occupancy.

- ① Requirements:
  - Mercedes me connect is available.
  - You have a user account for the Mercedes me Portal.
  - The service has been activated at an authorized Mercedes-Benz Center.

Further information can be found at: <https://www.mercedes.me>

- ① The online information is not available in all countries.

If **Display in COMAND** is activated in Traffic Sign Assist (→ page 181), speed limits and overtaking restrictions are displayed on the map.

- ① Company logos displayed on the map are trademarks of the respective companies and used solely for the purpose of indicating the locations of these companies. The use of such logos on the map does not indicate approval of, support of or advertising by these companies for the navigation system itself.

## Setting the map scale

### Requirements

- The map is shown.

Multimedia system:

→ [Navigation](#)

- ▶ **To zoom in:** swipe down on the Touch Control.  
or
- ▶ Turn the controller counter-clockwise.  
or
- ▶ Move two fingers apart on the touchpad.
- ▶ **To zoom out:** swipe up on the Touch Control.  
or
- ▶ Turn the controller clockwise.  
or
- ▶ Move two fingers together on the touchpad.

## Moving the map

Multimedia system:

- Navigation >>  Options
- >> Map Menu

- ▶ Alternatively, if the map is displayed in full screen mode, press the central control element. The map menu appears.
- ▶ Select "Move map" in map menu  (→ page 265).
- ▶ Swipe in any direction on the Touch Control or touchpad.

or

- ▶ Slide the controller in any direction. The map moves in the corresponding direction under the crosshair. The further you move your finger away from the starting position on the touchpad, the faster the map moves.

## Selecting the map orientation

Multimedia system:

- Navigation >>  Options
- >> Map Menu

- ▶ Alternatively, if the map is displayed in full screen mode, press the central control element. The map menu appears.
- ▶ In map menu , select **N**, **2D** or **3D** (→ page 265).
  - **N**: the 2D map view is displayed so that north is always at the top.
  - **2D**: the 2D map view is aligned to the direction of travel.
  - **3D**: the 3D map view is aligned to the direction of travel.

## Selecting POI symbols

Multimedia system:

- Navigation >>  Options
- >> Map Content

POIs include gas stations and hotels which can be displayed as symbols on the map, for example. Not all POIs are available everywhere.

- ▶ Select **POI Symbols**. The • dot indicates the current setting. **Standard** displays symbols of predefined categories on the map. **User Defined** allows you to personally select the symbols for the available categories. **None** switches the display off.
- ▶ Select a setting.
- ▶ **User Defined**: select categories. The POI symbols of the selected categories are displayed  or not displayed .

## Selecting the display of text information in the map

Multimedia system:

- Navigation >>  Options
- >> Text Information

- ▶ Select text information. **Current Street** shows the street you are currently driving on at the bottom of the display. When the map is moved, the following information appears under the crosshair:
  - Street name

- POI name
- Area name

**Geo-coordinates** displays the following information:

- Longitude and latitude
- Elevation

The elevation shown may deviate from the actual elevation.

- Number of satellites from which a signal can be received

When the map is moved, this information does not appear.

**Climate Control** displays the current climate control settings.

**None** switches the display off.

### Displaying the next intersecting street

#### Requirements:

- Route guidance is not active.

Multimedia system:

Navigation ► Options

- ▶ Activate  **Next Intersecting Street**.  
The name of the next intersecting street will be displayed at the upper edge of the display.

### Displaying the map version

Multimedia system:

Navigation ► Options

- ▶ Select **Map Version**.
- ▶ Select **Details**.
- ▶ Information about new versions of the digital map can be obtained from an authorized Mercedes-Benz Center.

### Overview of avoiding an area

You can define areas along a route that you would like to avoid.

The route can include an area that is to be avoided in the following situations:

- The destination is located in an area that is to be avoided
- Highways are located within the area that is to be avoided.

Highways are always taken into account for the route.

- There is no practical alternative route.

### Avoiding a new area

Multimedia system:



Navigation ► Route and Position  
► Avoid Options ► Areas

- ▶ Select **Avoid New Area**.
  - ▶ **To search for an area via the map:** select **Using Map**.
  - ▶ Move the map.
- or
- ▶ **To search for an area using an address:** select **Address Entry**.
  - ▶ Enter the address.
  - ▶ Select **Select Destination**.  
The map appears.
  - ▶ **To display an area:** press the Touch Control, the touchpad or the controller.  
A red rectangle appears. This designates the area that should be avoided.

- ▶ **To change the size of the area:** swipe up or down on the Touch Control or the touchpad.
- or
- ▶ Slide the controller up or down. The map scale is enlarged or reduced and changes the size of the area.
  - ▶ **To set the area:** press the Touch Control, the touchpad or the controller. The area is entered into the list.

### Changing an area

Multimedia system:

- ▶  **Navigation** ▶  **Route and Position**
- ▶ **Avoid Options** ▶ **Areas**
- ▶ Highlight an area in the list.
- ▶ Select  **Edit**.

### Moving the area on the map

- ▶ Swipe in any direction on the Touch Control or touchpad.
- or
- ▶ Slide the controller in any direction.

### Changing the size of the area





- ▶ **To start:** press the Touch Control, the touchpad or the controller.
  - ▶ **To change:** swipe up or down on the Touch Control or the touchpad.
- or
- ▶ Slide the controller up or down.
  - ▶ **To stop:** press the Touch Control, the touchpad or the controller.

### Taking the area for the route into account

- ▶ Avoid  an area in the list. If route guidance is active, a new route is calculated.
- ▶ If there is no route yet, the setting is carried over to the next route guidance.

### Deleting one or all areas

Multimedia system:

- ▶  **Navigation** ▶  **Route and Position**
- ▶ **Avoid Options** ▶ **Areas**
- ▶ Highlight an area in the list.
- ▶ Select  **Delete** or  **Delete All**.

- ▶ Confirm the prompt with **Yes**. One or all areas are deleted.

### Map data update overview

#### Updating at the authorized Mercedes-Benz Center

The digital maps generated by the map software become outdated in the same way as conventional road maps. Optimal route guidance can only be provided by the navigation system in conjunction with up-to-date map data. Information about new versions of the digital map can be obtained from an authorized Mercedes-Benz Center.

You can have updates to the digital map implemented there.

- ▶  Additional costs can be incurred in this process.

#### Online map update

The online map update service from Mercedes me connect can be used to update map data.

- ▶  The online map update service is not available in all countries.

The following options are available for the update:

- The automatic map update updates map data for one region.  
For automatic map updates **Automatic Online Update** must be activated in the system settings (→ page 243).
- The manual map update updates map data for several or all regions.

Further information on the online map update is available at an authorized Mercedes-Benz Center or at <https://www.mercedes.me>.

#### Overview of map data

Your vehicle is supplied with map data at the factory. Depending on the country, map data for your region is either pre-installed or the map data is supplied on a data storage medium.

If the map data on your vehicle has been installed at the factory and you wish to reinstall it, you do not need to enter the activation code.

For map data that you have purchased in the form of a data storage medium, you must enter the accompanying activation code.

-  If you save the map data on a data storage medium with the online map update service, no entry is required. The activation code is stored on the data storage medium during the downloading process.

Observe the following when entering the activation code:

- The activation code can be used for one vehicle
- The activation code is not transferable
- The activation code has six digits

In the event of the following problems, please contact an authorized Mercedes-Benz Center:

- The multimedia system does not accept the activation code
- You have lost the activation code

#### Displaying the compass

Multimedia system:

 **Navigation**  **Route and Position**

 Select **Compass**.

The compass display shows the following information:

- the current direction of travel with bearing (360° format) and compass direction
- longitude and latitude coordinates in degrees, minutes and seconds
- height (rounded)
- number of GPS satellites from which a signal can be received

#### Setting the map scale automatically

Multimedia system:

 **Navigation**  **Options**

The map scale is set automatically depending on your driving speed.

For journeys in cities with detailed city models, a map view from the driver's perspective is used.

 Switch **Auto Zoom** on  or off .



- ① The automatically selected map scale can be changed manually for a short time. The setting is reset automatically after a few seconds.

### Displaying the satellite map

Multimedia system:

Navigation » Options

» Map Content

- ▶ Switch **Satellite Map** on  or off .

or

- ▶ If satellite map display ⑥ is available in the map menu, switch it on  or off  (→ page 265).  
Switched on : satellite maps are displayed in map scales of 2 mi (2 km) or less.  
Switched off : no satellite maps are displayed.

- ① Satellite maps for these map scales are not available in all countries.

### Displaying weather information

#### Requirements

- Mercedes me connect is available.

- You have a user account for the Mercedes me Portal.
- The service is available.
- The service has been activated at an authorized Mercedes-Benz Center.

Further information is available at: <https://www.mercedes.me>

Multimedia system:

Navigation » Options

» Map Content

- ▶ Activate **Weather Information** .

or

- ▶ If weather information display ⑥ is available in the map menu, activate  (→ page 265) it. Current weather information is displayed on the navigation map, e.g. temperature or cloud cover.

- ① Weather information is not available in all countries.

## Telephone

### Telephony

#### Notes on telephony

- ⚠ **WARNING** Risk of distraction from operating integrated communication equipment while the vehicle is in motion

If you operate communication equipment integrated in the vehicle when driving, you could be distracted from the traffic situation. This could also cause you to lose control of the vehicle.

- ▶ Only operate this equipment when the traffic situation permits.
- ▶ If you cannot be sure of this, stop the vehicle whilst paying attention to road and traffic conditions and operate the equipment with the vehicle stationary.

**⚠ WARNING** Risk of accident from operating mobile communication equipment while the vehicle is in motion

Mobile communication devices distract the driver from the traffic situation. This can also cause the driver to lose control of the vehicle.



- ▶ As a driver, only operate mobile communication devices when the vehicle is stationary.
- ▶ As a vehicle occupant, use mobile communication devices only in the designated area, e.g. in the rear passenger compartment.

You must observe the legal requirements for the country in which you are currently driving when operating mobile communication equipment in the vehicle.

Further information can be obtained from an authorized Mercedes-Benz Center or at: <https://www.mercedes-benz-mobile.com/>

## Telephone menu overview



- ① Bluetooth® device name of the currently connected mobile phone
- ② Signal strength of the mobile phone network for the currently connected and selected mobile phone
- ③ Battery status of the currently connected and selected mobile phone
- ④  (telephone ready) or  (call active)

- ⑤ **Contacts** (→ page 279)
- ⑥ **Recent Calls** (→ page 281)
- ⑦ **Text Message**
- ⑧ One mobile phone connected: **Active Call**.  
Two mobile phones connected: changes view between telephone 1 and 2 or **Active Call**
- ⑨ **Devices** (→ page 274)

- ⑩ **Options**  
Symbols ① to ④ are not shown until after a mobile phone has been connected to the multimedia system. The symbols depend on your mobile phone and your mobile phone network provider.

**Bluetooth® profile overview**

Bluetooth® profile of the mobile phone	Function
PBAP (Phone Book Access Profile)	Contacts are automatically displayed in the multimedia system
MAP (Message Access Profile)	Message functions can be used

**Telephony operating modes overview**

Depending on your equipment, the following telephony operating modes are available:

- A mobile phone is connected to the multimedia system via Bluetooth® (→ page 274).
- Two mobile phones are connected with the multimedia system via Bluetooth® (two phone mode) (→ page 275).

**Information on telephony**

The following situations can lead to the call being disconnected while the vehicle is in motion:

- There is insufficient network coverage in the area
- You move from one GSM or UMTS transmitter/receiver area (cell) into another and no communication channels are free
- The SIM card used is not compatible with the network available
- A mobile phone with "Twincard" is logged into the network with the second SIM card at the same time

The multimedia system supports calls in HD Voice® for improved speech quality. A requirement for this is that the mobile phone and the mobile phone network provider of the person you are calling support HD Voice®.

Depending on the quality of the connection, the voice quality may fluctuate.

**Connecting a mobile phone (Bluetooth® telephony)****Requirements:**

- Bluetooth® is activated on the mobile phone (see the manufacturer's operating instructions).
- Bluetooth® is activated on the multimedia system (→ page 236).

Multimedia system:

➔ Phone ➔ ⌘ Devices

**Searching for a mobile phone**

- ▶ Select **Connect New Device**.
- ▶ Select **Start Search on System**.

The available mobile phones are displayed. If a new mobile phone is found, it is indicated by the  symbol.

**Connecting a mobile phone (authorization using Secure Simple Pairing)**

- ▶ Select the mobile phone. A code is displayed in the multimedia system and on the mobile phone.

- ▶ **If the codes match:** confirm the code on the mobile phone.

### Connecting a mobile phone (authorization by entering a passkey)

- ▶ Select the mobile phone.
- ▶ Choose a one to sixteen-digit number combination as a passkey.
- ▶ **On the multimedia system:** enter the passkey and select **OK**.
- ▶ **On the mobile phone:** enter the passkey again and confirm.

- ⓘ Up to 15 mobile phones can be authorized on the multimedia system.  
Authorized mobile phones are reconnected automatically.

### Connecting a second mobile phone (two phone mode)

#### Requirements:

- At least one mobile phone is already connected to the multimedia system via Bluetooth®.

Multimedia system:

↳ Phone ▶▶ ⌘ Devices

- ▶ Select **Connect New Device**.
  - ▶ Select **Start Search on System**.  
The available mobile phones are displayed.
  - ▶ Select the mobile phone.
  - ▶ Answer the **How would you like to connect the new device?** prompt.
  - ▶ **To replace the currently connected mobile phone:** select **Phone 1**.  
The currently connected mobile phone is replaced by the new mobile phone.
- or
- ▶ **To connect the second mobile phone:** select **Phone 2**.  
The new mobile phone is connected as **Phone 2**. If two mobile phones have already been connected, the second telephone is replaced by the new mobile phone.

or

- ▶ **To use the mobile phone as an audio source:** select **Audio Source** (→ page 308).

- ⓘ A mobile phone can be operated both as an audio source as well as telephone in parallel.
- ⓘ The type of connection for the connected mobile phone, for example as **Phone 1**, **Phone 2** or as **Audio Source**, can be redefined at any time. (→ page 275).

### Functions of the mobile phone in two phone mode

#### Functions overview

Mobile phone in the foreground	Mobile phone in the background
Full range of functions	Incoming calls

### Interchanging mobile phones (two phone mode)

#### Requirements:

- The mobile phones are authorized (→ page 274).

Multimedia system:

↳ Phone ▶▶ ⌘ Devices

- ▶ In the device overview, select a mobile phone which has already been authorized and set as **Phone 1** or **Phone 2**.

After interchanging the mobile phones, the mobile phone in the foreground is replaced by the mobile phone in the background.

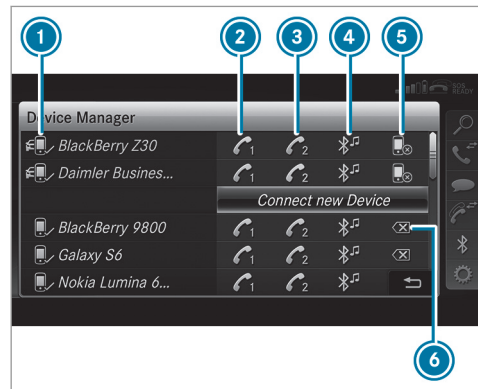

- ➊ Bluetooth® device name of the currently connected mobile phone
- ➋ Connects a mobile phone as **Phone 1**
- ➌ Connects a mobile phone as **Phone 2**
- ➍ Connects a mobile phone as **Audio Source**

- ➎ Disconnects a mobile phone(→ page 276)
- ➏ De-authorizes a mobile phone(→ page 276)

❗ If a new mobile phone is connected and defined as **Phone 1**, for example, this overwrites the previously connected mobile phone in the foreground of the system.

### Disconnecting a mobile phone

Multimedia system:

➔ Phone ➔ Bluetooth Devices

- ▶ Select the  symbol in the line of the mobile phone.  
The disconnection of the mobile phone takes place without a confirmation prompt. The mobile phone remains authorized in the system.

### De-authorizing a mobile phone

Multimedia system:

➔ Phone ➔ Bluetooth Devices

- ▶ Select the  symbol in the line of the mobile phone.

- ▶ Answer the confirmation prompt with **Yes**.  
The mobile phone is de-authorized and deleted from the system.

### Information on Near Field Communication (NFC)

NFC enables short-range wireless data transfer or (re)connection of a mobile phone with the multimedia system.

The following functions are available without having authorized a mobile phone:

- Transferring a URL to be viewed in the multimedia system (see the manufacturer's operating instructions).
- Setting up the vehicle's Wi-Fi access data via the system settings (→ page 237).

Further information can be found at: <https://www.mercedes-benz-mobile.com/>

### Using a mobile phone with Near-Field Communication (NFC)

#### Requirements:

- NFC is activated on the mobile phone (see the manufacturer's operating instructions)

- The mobile phone's screen is switched on and unlocked (see the manufacturer's operating instructions)

### Connecting a mobile phone

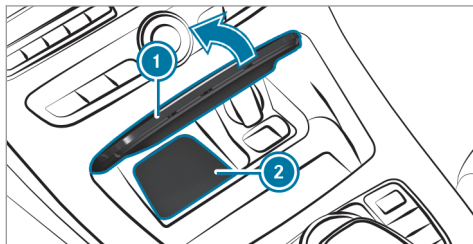

- ▶ Open storage compartment cover ①.
- ▶ Hold the NFC interface of the mobile phone (see manufacturer's operating instructions) on mat ② or place the mobile phone on mat ② with the display facing upwards. The mobile phone is connected to the multimedia system.
- ▶ Follow the additional prompts on the media display to connect the mobile phone.

### Replacing a mobile phone

- ▶ Hold the NFC interface of the mobile phone (see manufacturer's operating instructions) on mat ② or place the mobile phone on mat ② with the display facing upwards.

Further information can be found at: <https://www.mercedes-benz-mobile.com/>

### Setting the reception and transmission volume

#### Requirements:

- The mobile phone is authorized (→ page 274).

Multimedia system:

→ Phone ▶ ⚙️ Options ▶ Phone

This function ensures optimal language quality.

- ▶ Select **Reception Volume** or **Transmission Volume**.
- ▶ Set the volume.

Further information on the recommended reception and transmission volume: <https://www.mercedes-benz-mobile.com/>

### Adjusting the call and ringtone volume

Multimedia system:

→ System ▶ 📱 Audio ▶ Phone

- ▶ Select **Call Volume** or **Ringtone Volume**.
- ▶ Set the volume.

### Starting or stopping mobile phone voice recognition

#### Requirements:

- The mobile phone is connected to the multimedia system (→ page 274).

#### Starting mobile phone voice recognition

- ▶ Press and hold the  button on the multi-function steering wheel for more than one second. You can use mobile phone voice recognition.

#### Stopping mobile phone voice recognition

- ▶ Press the  or  button on the multi-function steering wheel.

## Calls

### Telephone operation

Multimedia system:

→ Phone →  Contacts

### Making a call

- ▶ Select **Numerical Keypad**.
- ▶ Enter the number.
- ▶ Select . The call is made.

### Accepting a call

- ▶ Select **Accept**.

### Rejecting a call

- ▶ Select **Reject**.

### Ending a call

- ▶ Select .

### Activating functions during a call

- ▶ To show all functions, navigate down.

The following functions are available during a call:

- **End Call**

- **Make Additional Call**
- **Keyboard** (show to send DTMF tones)
- Switch **Mute Mic** on  or off .
- **Private Mode** (an active call in hands-free mode is transferred over to the telephone)

### Conducting calls with several participants

#### Requirements:

- There is an active call (→ page 278).
- Another call is being made.

### Switching between calls

- ▶ Select call ●.  
The selected call is active. The other call is on hold.

### Activating or ending a call on hold

- ▶ Select **Continue Call** or **End Call**.

### Conducting a conference call

- ▶ Select **Create Conference Call** in the telephone menu.  
The new participant is included in the conference call.

### Ending an active call

- ▶ Select .

**i** On some mobile phones, the call on hold is activated as soon as the active call is ended.

### Accepting/rejecting a waiting call

#### Requirements:

- There is an active call (→ page 278).

If you receive a call while already in a call, a message is displayed. An acoustic signal also sounds.

- ▶ Select **Accept**.  
The incoming call is active.

If only one mobile phone is connected with the multimedia system, the previous call will be put on hold.

If during a call you accept a call with the other mobile phone when in two phone mode then the existing call is ended.

- ▶ Select **Reject**.

**i** This function and behavior depends on your mobile phone network provider and the mobile phone (see the manufacturer's operating instructions).



## Contacts

### Information about the contacts menu

The contacts menu contains all contacts from existing data sources, e.g. mobile phone or memory card. You can store up to 6,000 contacts.

Depending on the data source, you have the following number of contacts:

- Permanently saved contacts: 3,000 entries
- Contacts loaded from the mobile phone: 3,000 entries

From the contacts menu, you can perform the following actions:

- Using the telephone:
  - Calling a contact (→ page 280)
  - Calling a new number (→ page 278)
- Navigation (→ page 252)
- Compose messages (→ page 282)

If a mobile phone is connected to the multimedia system (→ page 274) and automatic calling up (→ page 279) is activated, the mobile phone's contacts are displayed in the address book.

### Downloading mobile phone contacts

Multimedia system:

↳ Phone »  Options » Contacts

#### Automatically

- ▶ Switch **Synchronize Contacts Automatically** on .

#### Manually

- ▶ Deactivate  **Synchronize Contacts Automatically**.
- ▶ Select **Synchronize Contacts**.

### Calling up contacts

Multimedia system:

↳ Phone »  Contacts

Depending on the character set, the following options can be used to search for contacts:

- searching by initials
- searching by name
- searching by phone number

- ▶ Enter characters into the search field. A selection of possible contacts appears. Entering more characters into the search field narrows down the number of possible selections.

- ▶ Select the contact.

A contact can contain the following details:

- phone numbers
- navigation addresses
- geo-coordinates
- Internet address

### Editing the format of a contact's name

Multimedia system:

↳ Phone »  Options » Contacts » Name Format





The following options are available:

- **Last Name, First Name**
- **Last Name First Name**
- **First Name Last Name**

- ▶ Select an option.

## Overview of importing contacts

### Contacts from various sources

Source	Requirements
 Memory card	The SD card is inserted.
 USB device	The USB device is inserted in the USB port.
 Bluetooth® connection	Bluetooth® is activated in the multimedia system and on the respective device (see the manufacturer's operating instructions).
 Mobile phone	The mobile phone is connected to the multimedia system.

- i** Note that the imported contacts remain in the vehicle and can be accessed at any time regardless of the connected mobile phones.

- i** If the sending of vCards via Bluetooth® is supported, vCards can be received on mobile phones or netbooks, for example.

### Importing contacts into the contacts menu

Multimedia system:



➤ Phone ➤  Options ➤ Contacts

- ▶ Select **Import**.
- ▶ Select an option.

### Saving a mobile phone contact

Multimedia system:

➤ Phone ➤  Contacts

- ▶ Select the mobile phone contact .
- ▶ Select .
- ▶ Select **Save to Vehicle**.

The contact saved in the multimedia system is identified by the  symbol.

### Calling a contact

Multimedia system:

➤ Phone ➤  Contacts

- ▶ Enter characters into the search field.

- ▶ Select the contact.
- ▶ Select the telephone number. The number is dialed.

### Selecting further options in the contacts menu

Multimedia system:

➤ Phone ➤  Contacts

- ▶ Select a contact.
- ▶ Select .

Depending on the stored data, the following options are available:

- **Call**
  - **Send Text Message**
  - **Show Website** (if an Internet address has been stored)
  - **Navigate** (if an address has been stored)
  - **Save My Favorite**
  - **Send DTMF Tones** (for a number with DTMF tones)
- ▶ Select an option.

### Deleting a contact

Multimedia system:

☛ Phone >> 🔍 Contacts

You can delete contacts stored in the vehicle.

- ▶ Search for the contact.
- ▶ Select the contact.
- ▶ Select .
- ▶ Select **Delete Contact**.
- ▶ Select **Yes**.

### Call list

#### Call list overview

Depending on whether your mobile phone supports the PBAP Bluetooth® profile or not, this can have different effects on the presentation and functions of the call list.

If the PBAP Bluetooth® profile is supported, the effects are as follows:

- The call lists from the mobile phone are displayed in the multimedia system.

- When connecting the mobile phone, you may have to confirm the connection for the PBAP Bluetooth® profile.

If the PBAP Bluetooth® profile is not supported, the effects are as follows:

- The multimedia system generates its own call lists.
- The call list is not synchronized with the call lists in the mobile phone.

#### Making a call from the call list

Multimedia system:

☛ Phone >> 📞 Recent Calls

- ▶ Select a number.  
The call is made.

### Text messages

#### Overview of text message functions

If the connected mobile phone supports the MAP Bluetooth® profile, the text message functions can be used on the multimedia system.

You can obtain further information about settings and supported functions of Bluetooth®-capable

mobile phones at an authorized Mercedes-Benz Center or at: <https://www.mercedes-benz-mobile.com/>

Some mobile phones require further settings after being connected to the multimedia system (see manufacturer's operating instructions).

New messages are identified by the  symbol in the media display and an audible signal.

Depending on the mobile phone, the multimedia system only displays new incoming text messages or the 100 newest text messages.

#### Configuring the text messages displayed

Multimedia system:

☛ Phone >> ⚙️ Options >> Text Message >> Message Display

- ▶ Select .

A menu with the following options is shown:

- [All Messages](#)
- [New and Unread Messages](#)
- [New Messages](#)

- **Off** (The text messages are not displayed automatically.)
- ▶ Select an option.
- ⓘ The setting may not be active until the mobile phone is reconnected.

### Reading text messages

Multimedia system:

↳ Phone ▶  Text Message

### Reading a text message

- ▶ Select a text message.  
The message text is displayed.

### Using the read-aloud function

- ▶ Select a text message.
- ▶ Select **Read Aloud**.  
The text message is read aloud.

### Composing and sending a text message

Multimedia system:

↳ Phone ▶  Text Message

- ▶ Select **Write New Text Message**.

### Adding a recipient

- ▶ Select **Press to Add Recipient**.
- ▶ Select the contact.

### Dictating text

- ▶ Select **Press to Dictate**.
- ▶ **To start the dictation function:** press on the central control element.  
The app for the dictation function is loaded.  
If there was no prior Internet connection, a connection is now established.
- ▶ Say the message.  
The dictation ends automatically after you have finished speaking.  
After the voice message has been processed, it is shown as text.
- ▶ **To replace a message:** select **Replace message**.  
The text that has been dictated and shown on the display is reset and can be dictated again.

### Editing text

- ▶ Select the word.

- ▶ **To call up the correction menu:** press on the central control element.

The following options are available:

- Adjusting the capitalization of words (if supported by the character set)
- Expanding the choice of words
- Deleting the selection
- Recording a new dictation

- ▶ **To leave the menu:** select **Done**.

### Sending text messages

- ▶ Select **Send Text Message**.

### Replying to a text message

Multimedia system:

↳ Phone ▶  Text Message

- ▶ Open the text message.
- ▶ Select .
- ▶ Select **Reply**.

### Calling a text message sender

Multimedia system:

Phone >> Text Message

- ▶ Open the text message.
- ▶ Select .
- ▶ Select **Call Sender**.

### Deleting text messages

Multimedia system:

Phone >> Text Message

- ▶ Select .
  - ▶ **To delete a text message:** select **Delete**.
  - ▶ **Outbox**
- or
- ▶ Select **Drafts**.

## Mercedes-Benz link

### Overview of Mercedes-Benz Link

**⚠ WARNING** Risk of distraction from information systems and communications equipment

If you operate information systems and communication devices integrated in the vehicle when driving, you could be distracted from the traffic situation. This could also cause you to lose control of the vehicle.

- ▶ Only operate this equipment when the traffic situation permits.
- ▶ If you cannot be sure of this, stop the vehicle whilst paying attention to road and traffic conditions and operate the equipment with the vehicle stationary.

Using Mercedes-Benz Link, various functions and selected mobile phone apps can be transferred to the media display.

The Mercedes-Benz Link control box supplementary equipment is required for this. You can obtain this at an authorized Mercedes-Benz Center.

- ⓘ The Mercedes-Benz Link control box uses the Android operating system.
- ⓘ The service provider is responsible for the apps as well as the services and content connected to it.

### Connecting Mercedes-Benz Link with the multimedia system

- ▶ Connect the Mercedes-Benz Link control box with the  USB port of the multimedia connection unit using a suitable connecting cable.
- ⓘ A suitable connecting cable is available separately at an authorized Mercedes-Benz Center.

### Using Mercedes-Benz Link

#### Requirements:

- The Mercedes-Benz Link control box is connected with the multimedia system using the  USB port.

Multimedia system:

➔ **Connect** ➔ **Mercedes-Benz Link**

▶ Select **MB Link**.

The mobile phone functions and apps are available and shown on the media display.

You can find more information in the Mercedes-Benz Link control box operating instructions.

### Ending Mercedes-Benz Link

Multimedia system:

➔ **Connect** ➔ **Mercedes-Benz Link**

▶ Select **Disconnect**.

The connection is ended.

The mobile phone continues to be supplied with electricity.

or

▶ Disconnect the connecting cable between the Mercedes-Benz Link control box and the multimedia system.

ⓘ Mercedes-Benz recommends disconnecting the connecting cable only when the vehicle is stationary.

## Apple CarPlay®

### Overview of Apple CarPlay®

**⚠ WARNING** Risk of distraction from information systems and communications equipment

If you operate information systems and communication devices integrated in the vehicle when driving, you could be distracted from the traffic situation. This could also cause you to lose control of the vehicle.

- ▶ Only operate this equipment when the traffic situation permits.
- ▶ If you cannot be sure of this, stop the vehicle whilst paying attention to road and traffic conditions and operate the equipment with the vehicle stationary.

Observe the legal requirements for the country in which you are currently driving when operating the multimedia system. iPhone® functions can be used via the multimedia system using Apple CarPlay®. They are operated using the central control element or the Siri®

voice control system. You can activate the voice control system by pressing and holding the  button on the multifunction steering wheel.

Only one mobile phone at a time can be connected via Apple CarPlay® to the multimedia system.

The availability of Apple CarPlay® may vary according to the country.

The service provider is responsible for this application and the services and content connected to it.

Apple CarPlay® is a registered trademark of Apple Inc.

### Information on Apple CarPlay®

While using Apple CarPlay® various functions of the multimedia system, e.g. telephony or the media sources Bluetooth® audio and iPod®, are unavailable.

Only one route guidance can be active at a time. If route guidance is active on the multimedia system, it is closed when route guidance is started on the mobile phone.

## Connecting an iPhone® via Apple CarPlay®

### Requirements:

- Apple® operating system version iOS 8.3 or above is installed on the iPhone®.
- An Internet connection is required for the full range of functions for Apple CarPlay®.
- The iPhone® is connected to the multimedia system via the USB port  using a suitable cable (→ page 302).

Multimedia system:

➔ [Connect](#) ➔ [Apple CarPlay](#)

### Setting automatic or manual start

A message appears when connected for the first time.

- ▶ **Automatic start:** select [Automatically](#). [Start Automatically](#) is activated .
- ▶ Apple CarPlay® will now start immediately after the iPhone® is connected to the multimedia system using a USB cable.
- ▶ **Manual start:** select [Manually](#).
- ▶ Select the iPhone® in the device list.

## Accepting/rejecting the data protection regulations

A message with the data protection regulations appears.

- ▶ Select [Accept & Start](#).
- or
- ▶ Select [Decline & End](#).

## Exiting Apple CarPlay®

- ▶ Press the  button on the multifunction steering wheel, for example.
- ⓘ If Apple CarPlay® was not displayed in the foreground before disconnecting, the application starts in the background when reconnected. You can call up Apple CarPlay® in the main menu.

## Calling up Apple CarPlay® sound settings

Multimedia system:

- ➔ [Connect](#) ➔ [Apple CarPlay](#) ➔ [Sound](#)
- ▶ Select the sound menu (→ page 318).

## Ending Apple CarPlay®

Multimedia system:

➔ [Connect](#) ➔ [Apple CarPlay](#)

- ▶ Select [Disconnect](#).  
The connection is ended.  
The mobile phone continues to be supplied with electricity.
- or
- ▶ Disconnect the connecting cable between the mobile phone and multimedia system. Mercedes-Benz recommends disconnecting the connecting cable only when the vehicle is stationary.

## Android Auto

### Android Auto overview

**⚠ WARNING** Risk of distraction from information systems and communications equipment

If you operate information systems and communication devices integrated in the vehicle

when driving, you could be distracted from the traffic situation. This could also cause you to lose control of the vehicle.

- ▶ Only operate this equipment when the traffic situation permits.
- ▶ If you cannot be sure of this, stop the vehicle whilst paying attention to road and traffic conditions and operate the equipment with the vehicle stationary.

Observe the legal requirements for the country in which you are currently driving when operating the multimedia system.

Mobile phone functions can be used with Android Auto using the Android operating system on the multimedia system. It is operated using the central control element or voice control system. You can activate the voice control system by pressing and holding the  button on the multifunction steering wheel.

Only one mobile phone at a time can be connected via Android Auto with the multimedia system. The availability of Android Auto and Android Auto apps may vary according to the country.

The service provider is responsible for this application and the services and content connected to it.

#### Information on Android Auto

While using Android Auto, various functions of the multimedia system, for example the media source Bluetooth® audio, are not available.

Only one route guidance can be active at a time. If route guidance is active on the multimedia system, it is closed when route guidance is started on the mobile phone.

#### Connecting a mobile phone via Android Auto

##### Requirements:

- The first activation of Android Auto on the multimedia system must be carried out when the vehicle is stationary for safety reasons.
- The mobile phone supports Android Auto from Android 5.0.
- The Android Auto app is installed on the mobile phone.

- In order to use the telephone functions, the mobile phone must be connected to the multimedia system via Bluetooth® (→ page 274).

If there was no prior Internet connection, this is established with the use of the mobile phone with Android Auto.

- The mobile phone is connected to the multimedia system via the USB port  using a suitable cable (→ page 302).
- An Internet connection is required for the full range of functions for Android Auto.

Multimedia system:

 [Connect](#)  [Android Auto](#)

-  Select the mobile phone from the device list.

#### Accepting/rejecting the data protection regulations

A message with the data protection regulations appears.

-  Select [Accept & Start](#).

or

-  Select [Decline & End](#).



**Activating automatic start**

- ▶ Select **Start Automatically** .

**Starting manually**

- ▶ Select the mobile phone from the device list.

**Exiting Android Auto**

- ▶ Press the  button on the multifunction steering wheel, for example.

**i** If Android Auto was not displayed in the foreground before disconnecting, the application starts in the background when reconnected. You can call up Android Auto in the main menu.

**Calling up the Android Auto sound settings**

Multimedia system:

↳ **Connect** ▶▶ **Android Auto** ▶▶ **Sound**

- ▶ Select the tone menu (→ page 318).

**Ending Android Auto**

Multimedia system:

↳ **Connect** ▶▶ **Android Auto**

- ▶ Select **Disconnect**.  
The connection is ended.

The mobile phone continues to be supplied with electricity.

or

- ▶ Disconnect the connecting cable between the mobile phone and multimedia system. Mercedes-Benz recommends disconnecting the connecting cable only when the vehicle is stationary.

**Transferred vehicle data with Android Auto and Apple CarPlay®****Overview of transferred vehicle data**

When using Android Auto or Apple CarPlay®, certain vehicle data is transferred to the mobile phone. This enables you to get the best out of selected mobile phone services. Vehicle data is not directly accessible.

The following system information is transmitted:

- Software release of the multimedia system
- System ID (anonymised)

The transfer of this data is used to optimize communication between the vehicle and the mobile phone.

To do this, and to assign several vehicles to the mobile phone, a vehicle identifier is randomly generated.

This has no connection to the vehicle identification number (VIN) and is deleted when the multimedia system is reset (→ page 244).

The following driving status data is transmitted:

- Transmission position engaged
- Distinction between parked, standstill, rolling and driving
- Day/night mode of the instrument display

The transfer of this data is used to alter how content is displayed to correspond to the driving situation.

The following position data is transmitted:

- Coordinates
- Speed
- Compass direction
- Acceleration direction

This data is only transferred while the navigation system is active in order to improve it (e.g. so it can continue functioning when in a tunnel).

## Mercedes me calls

### Making a call via the overhead control panel

#### Requirements:

- You have access to a GSM network.
- The contract partner's GSM network coverage is available in the respective region.
- The ignition is switched on so that vehicle data can be transferred automatically.

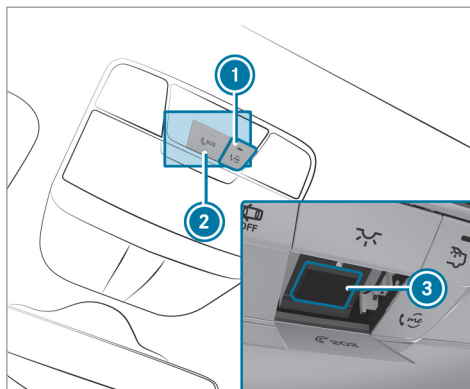

- ① me button for service or information calls
- ② SOS button cover
- ③ SOS button

#### Making a Mercedes me call

- ▶ Press button ①.

#### Making an emergency call

- ▶ To open the cover of SOS button ②, press it briefly.
- ▶ Press and hold SOS button ③ for at least one second.

If a Mercedes me call is active, an emergency call can still be triggered. This has priority over all other active calls.

#### Information about the Mercedes me call using the me button

A call to the Mercedes-Benz Customer Center has been initiated via the me button in the overhead control panel or the multimedia system.

Using the voice control system, you can select one of the following services:

- Accident and breakdown management (→ page 292)
- Mercedes-Benz Customer Center for general information about the vehicle

You can find information on the following topics:

- Activation of Mercedes me connect
- Operating the vehicle

- Nearest authorized Mercedes-Benz Center
- Other products and services from Mercedes-Benz

Data is transferred during the connection to the Mercedes-Benz Customer Center (→ page 290).

### Calling the Mercedes-Benz Customer Center using the multimedia system

#### Requirements:

- You have access to a GSM network.
- The contract partner's GSM network coverage is available in the respective region.
- The ignition is switched on so that vehicle data can be transferred automatically.

Multimedia system:

→ Phone →  Contacts

- ▶ Call **Mercedes me connect**.  
The call is made.

After confirmation, the multimedia system sends the required vehicle data. The data transfer is shown in the media display.

Then, you can select a service and be connected to a specialist at the Mercedes-Benz Customer Center.

### Calling the Mercedes-Benz Customer Center after automatic accident or breakdown detection

#### Requirements:

- The vehicle has detected an accident or breakdown situation.
  - The vehicle is stationary.
  - The hazard warning lights are switched on.
-  This function is not available in all countries.

In limited situations the vehicle can detect accident or breakdown situations.



In the event an accident or breakdown is detected, the emergency guide shows safety notes in the multimedia system display.

After quitting the emergency guide display on the multimedia system, a prompt appears asking whether you wish to get support from the Mercedes-Benz Customer Center.

- ▶ Select **Call**.

- After your agreement, or if the Mercedes me connect service "Accident and Breakdown Management" is active, the vehicle data is transferred automatically (→ page 292).
- A Mercedes-Benz Customer Center employee takes your call and organizes the breakdown and accident assistance.

You may be charged for these services.

-  Depending on the severity of the accident, an automatic emergency call can be initiated. This has priority over all other active calls.
-  In addition, if the Mercedes me connect service "Telediagnosics" is active, a similar prompt can appear after a delay in the event of a breakdown. If you are already in contact with the Mercedes-Benz Customer Center or have already received support, this prompt can be ignored or declined.
-  If you answer the prompt for support from the Mercedes-Benz Customer Center with **Later**, the message will be hidden and appear again later.

The prompt triggered by the Mercedes me connect service "Telediagnosics", can either be confirmed or declined. After being declined, this will not be shown again.

### Arranging a service appointment via a Mercedes me call

If you have activated the maintenance management service, relevant vehicle data is transferred automatically to the Mercedes-Benz Customer Center. You will then receive individual recommendations regarding the maintenance of your vehicle.

Regardless of whether you have consented to the maintenance management service, the multimedia system reminds you after a certain amount of time that a service is due. A prompt appears asking if you would like to make an appointment.

▶ **To arrange a service appointment:** select **Call**. After your agreement the vehicle data is sent and a Mercedes-Benz Customer Center employee deals with your appointment. The information is then sent to your desired service outlet.

This will contact you to confirm the appointment and if necessary consult about the details.

❗ If you select **Later** after the service message appears, the message is hidden and reappears at a later time.

### Transferred data during a Mercedes me call

If you initiate a service call using Mercedes me, data is transferred to enable targeted advice and an efficient service.

The following requirements must be fulfilled for the transfer of the data:

- The ignition is switched on.
- The required data transfer technology is supported by the mobile phone network provider.
- The quality of the mobile connection is sufficient.

Multi-stage transfer depends on the following factors:

- Reason for the initiation of the call
- The available mobile phone transmission technology.

- The activated Mercedes me connect services.
- The service selected in the voice control system.

### Data transfer if Mercedes me connect services are not activated

If no Mercedes me connect services are activated, the following data is transferred:

- Vehicle identification number
- Time of the call
- Reason for the initiation of the call
- Confirmation of the data protection prompt
- Country indicator of the vehicle
- Set language for the multimedia system
- Telephone number of the communication platform installed in the vehicle

If a call is made for a service appointment via the service reminder, the following data is also transmitted:

- Current mileage and maintenance data

If a call is made after automatic accident or breakdown detection using the multimedia system, the following data is also transmitted:

- Current mileage and maintenance data
- Current vehicle location

If Accident and Breakdown Management is called via the voice control system and no service has been activated, the following data can also be called up from the vehicle by the Mercedes-Benz Customer Center:

- Current vehicle location

#### **Data transfer if Mercedes me connect services are activated**

Only if the respective service is activated will additional incident-specific data be transmitted in the second stage to enable an optimal service.

An overview of the data transmitted can be found in the respective terms of use for Mercedes me connect services. These can be obtained in the Mercedes me Portal: <https://me.secure.mercedes-benz.com>

#### **Data processing**

The data transmitted within the scope of the call is deleted from the processing system after the call is finished, in so far as this data is not being used for other activated Mercedes me connect services.

The incident-specific data is processed and stored in the Mercedes-Benz Customer Center and, if required to process the incident, forwarded to the service partner authorized by the Mercedes-Benz Customer Center. Please take note of the data protection information on the Mercedes me Internet page <https://www.mercedes.me> or in the recorded message immediately after calling the Mercedes-Benz Customer Center.

- ⓘ The recorded message is not available in every country.

#### **Mercedes me connect**

##### **Information on Mercedes me connect**

Mercedes me connect provides the following services:

- Accident and breakdown management (me button)
- Mercedes-Benz emergency call system (automatic emergency call and SOS button)

The Mercedes-Benz Customer Center and the Mercedes-Benz emergency call center are available for you around the clock.

The me button and the SOS button can be found on the vehicle's overhead control panel (→ page 288).

You can also call the Mercedes-Benz Customer Center using the multimedia system (→ page 289).

Please note that Mercedes me connect is a Mercedes-Benz service. In emergencies, first call the national emergency services using the standard national emergency service telephone numbers. In emergencies, you can also use the

Mercedes-Benz emergency call system (→ page 293).

Observe the conditions of use for Mercedes me connect and other services. These can be obtained in the Mercedes me Portal: <https://me.secure.mercedes-benz.com>

### Information on Mercedes me connect Accident and Breakdown Management

The Accident and Breakdown Management can include the following functions:

- Supplement to the Mercedes-Benz emergency call system (→ page 293)

If necessary, the contact person at the Mercedes-Benz emergency call center forwards the call to Mercedes me connect Accident and Breakdown Management. Forwarding the call is however not possible in all countries.

- Breakdown assistance by a technician on location and/or the towing away of the vehicle to the nearest authorized Mercedes-Benz Center  
You may be charged for these services.

More information about Mercedes me connect services can be obtained in the Mercedes me Portal: <https://me.secure.mercedes-benz.com>

### Data transferred during Mercedes me connect call services

The data transferred during a Mercedes me connect call depends on:

- The reason for initiation of the call
- The service that is selected in the voice control system
- The activated Mercedes me connect services

Which data is transferred for the services can be taken from the currently valid terms of use. These can be obtained in the Mercedes me portal: <https://me.secure.mercedes-benz.com>

### Mercedes-Benz emergency call system

#### Information on the Mercedes-Benz emergency call system

Your vehicle is equipped with the Mercedes-Benz emergency call system ("eCall"). This feature can help save lives in the event of an accident. eCall

in no way replaces assistance provided from dialing 911.

The Mercedes-Benz emergency call system is available for at least ten years starting from the manufacturing date.

Mercedes-Benz eCall only functions in areas where mobile phone coverage is available from the wireless service providers. Insufficient network coverage from the wireless service providers may result in an emergency call not being transmitted.

eCall is a standard feature in your Mercedes-Benz vehicle. In order to function as intended, the system relies on the transmission of data detailed in the Transmitted Data section that follows (→ page 294).

To disable eCall, a customer must visit an authorized Mercedes-Benz Service department to deactivate the vehicle's communication module.

**Deactivation of this module prevents the activation of any and all Mercedes me connect services. After the deactivation of eCall, automatic emergency call and manual emergency call will not be available.**

The ignition must be switched on before an automatic emergency call can be made.

- ❗ eCall is activated at the factory.
- ❗ eCall can be deactivated by an authorized Mercedes-Benz dealer. Please note that in the event ownership of the vehicle is transferred to another owner in its deactivated state, eCall will remain deactivated unless the new owner visits an authorized Mercedes-Benz dealership to reactivate the system.

### Overview of the Mercedes-Benz emergency call system

eCall can help to reduce the time between an accident and the arrival of emergency services at the site of the accident. It helps locate an accident site in places that are difficult to access. However, even if a vehicle is equipped with eCall, this does not mean the system is ON. As such, eCall does not replace dialing 911 in the event of an accident.

An emergency call can be made automatically (→ page 293) or manually (→ page 294).

Only make emergency calls if you or others are in need of rescue. Do not make an emergency call in the event of a breakdown or a similar situation.

### Displays in the media display:

**SOS READY:** eCall available

**SOS NOT READY:** the ignition is not on or eCall is not available.

During an active emergency call,  appears in the display.

You can find more information on the regional availability of the Mercedes-Benz Emergency Call System at: <https://www.mercedes-benz-mobile.com/extra/ecall/>

- ❗ If there is a malfunction in the emergency call system (e.g. a malfunction with the speaker, microphone, air bag, SOS button), a corresponding message appears on the instrument cluster display.

### Triggering an automatic emergency call

#### Requirements

- The ignition is switched on.
- The starter battery is sufficiently charged.

If restraint systems such as airbags or Emergency Tensioning Devices have been activated after an accident, the Mercedes-Benz emergency call system may automatically initiate an emergency call.

The emergency call has been made:

- A voice connection is made to the Mercedes-Benz emergency call center.
- A message with accident data is transmitted to the Mercedes-Benz emergency call center. The Mercedes-Benz emergency call center can transmit the vehicle position data to one of the emergency call centers.

The SOS button in the overhead control panel flashes until the emergency call is finished.

It is not possible to immediately end an automatic emergency call.

If no connection can be made to the emergency services either, a corresponding message appears in the media display.

- ▶ Dial the local emergency number on your mobile phone.

If an emergency call has been initiated:

- Remain in the vehicle if the road and traffic conditions permit you to do so until a voice connection is established with the emergency call center operator.
- Based on the call, the operator decides whether it is necessary to call rescue teams and/or the police to the accident site.
- If no vehicle occupant answers, an ambulance is sent to the vehicle immediately.

#### Triggering a manual emergency call

- ▶ Press and hold the SOS button in the overhead control panel for at least one second.

The emergency call has been made:

- A voice connection is made to the Mercedes-Benz emergency call center.
- A message with accident data is transmitted to the Mercedes-Benz emergency call center.

The Mercedes-Benz emergency call center can transmit the vehicle position data to one of the emergency call centers.

- Remain in the vehicle if the road and traffic conditions permit you to do so until a voice connection is established with the emergency call center operator.
- Based on the call, the operator decides whether it is necessary to call rescue teams and/or the police to the accident site.

If no connection can be made to the emergency services either, a corresponding message appears in the media display.

- ▶ Dial the local emergency number on your mobile phone.

#### Ending an unintentional emergency call

- ▶ **On the multifunction steering wheel:** select . Depress the button for several seconds.

#### Data transfer of the Mercedes-Benz emergency call system

In the event of an automatic or manual emergency call the following data is transmitted, for example:

- Vehicle's GPS position data
- GPS position data on the route (a few hundred meters before the incident)

- Direction of travel
- Vehicle identification number
- Vehicle drive type
- Number of people determined to be in the vehicle
- Whether Mercedes me connect is available or not
- Whether the emergency call was initiated manually or automatically
- Time of the accident
- Language setting on the multimedia system

Data transmitted is vehicle information. For any questions about the collection, use and sharing of the eCall system data, please contact MBUSA's Customer Assistance Center at 800-FOR-MERC.

For Canada, please contact MBC's Customer Assistance Center at 1-800-387-0100.

Customer requests for covered information should be submitted via the same channels.



For accident clarification purposes, the following measures can be taken up to an hour after the emergency call has been initiated:

- The current vehicle position can be determined.
- A voice connection to the vehicle occupants can be established.

## Online and Internet functions

### Internet connection

#### Information on connecting to the Internet

**⚠ WARNING** Risk of distraction from information systems and communications equipment

If you operate information systems and communication devices integrated in the vehicle when driving, you could be distracted from the traffic situation. This could also cause you to lose control of the vehicle.

- ▶ Only operate this equipment when the traffic situation permits.

- ▶ If you cannot be sure of this, stop the vehicle whilst paying attention to road and traffic conditions and operate the equipment with the vehicle stationary.

You must observe the legal requirements for the country in which you are currently driving when operating the multimedia system.

**⚠ WARNING** Risk of accident from operating mobile communication equipment while the vehicle is in motion

Mobile communication devices distract the driver from the traffic situation. This can also cause the driver to lose control of the vehicle.

- ▶ As a driver, only operate mobile communication devices when the vehicle is stationary.
- ▶ As a vehicle occupant, use mobile communication devices only in the designated area, e.g. in the rear passenger compartment.

You must observe the legal requirements for the country in which you are currently driving when operating mobile communication equipment in the vehicle.

The Internet functions can only be used to a limited degree whilst driving.

#### Function of the communication module

On vehicles with a built-in communication module, the Internet connection is established via an integrated SIM card.

To use Internet access via the communication module the following conditions must be met:

- The vehicle is equipped with a permanently installed communication module.
- Mercedes me connect is active and ready for operation.
- Mercedes me connect is activated for Internet access.

For most Mercedes me connect services, data volume is available when purchasing the services.

Additional data volume is required to use some functions, e.g. Internet radio or Wi-Fi hotspot.

If the data volume limit is reached, the availability of Mercedes me connect services is limited. The data volume can be purchased **directly from a mobile phone network provider** via the Mercedes me Portal.

- ① Visit an authorized Mercedes-Benz Center to find out whether it is possible to purchase data volume in your country **directly from a mobile phone network provider**.

## Connection status

### Connection status overview



- ① Display of the communication module reception field strength
- ② Display of existing connection

### Displaying the connection status

Multimedia system:

➤ System ➤ 📶 Connectivity

- Select **Internet Status**.

- ① In the case of a connection via the communication module the following status information is shown:

- Type of network
- Status online/offline

## Mercedes-Benz Apps

### Calling up Mercedes-Benz Apps

#### Requirements:

- The registration for the use of Mercedes-Benz Apps has been completed.
- The general terms and conditions have been confirmed.

Multimedia system:

➤ Connect ➤ 📶 Mercedes-Benz Apps

- Select an app.

- ① The available features are country-dependent. License fees may be applicable.

## Using Mercedes-Benz Apps with voice control

### Requirements:

- The registration for the use of Mercedes-Benz Apps has been completed.
- The general terms and conditions have been confirmed.

The  symbol indicates that a Mercedes-Benz app can be used via voice control.

▶ Select a Mercedes-Benz app.  
The app menu is displayed.

▶ **To use voice control:** select  **Language**.

▶ Say the question or command.

ⓘ Voice control is not available in all countries and languages.

## Tuneln Radio

### Calling up Tuneln Radio

#### Requirements:

- The Internet Radio service is activated.
- The data volume is available.

Depending on the country, data volume may need to be purchased.

- A fast Internet connection for data transmission free of interference.

The services are country-dependent.

For more information, consult an authorized Mercedes-Benz Center.

Multimedia system:

➔ **Radio** ➔  **Radio Source**

▶ Select **Tuneln Radio**.

The Tuneln Radio display appears. The last station set starts playing.

ⓘ The connection quality depends on the local mobile phone reception.

## Overview of Tuneln Radio

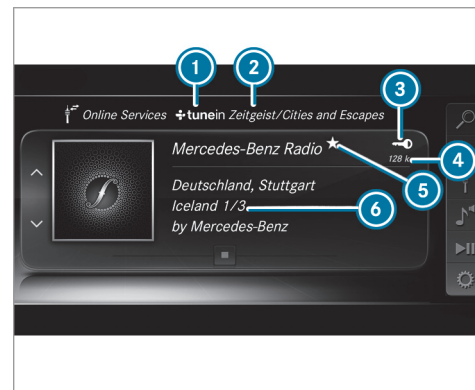

- 1 Internet Radio provider
- 2 Selected category
- 3 Display (if connected to private user account)
- 4 Data transfer rate
- 5 Current station is stored as a favorite
- 6 Additional information on the current station

### Selecting and connecting Tuneln Radio stations

Multimedia system:

→ Radio ▶  Radio Source  
 ▶▶ Tuneln Radio ▶▶  Search

- ▶ Select a category.
- ▶ Select a station.
- ▶ The connection is established automatically.

or

- ▶ Select **Enter Address or POI**.
- ▶ Enter a station name using the entry field.
- ⓘ A relatively large volume of data can be transmitted when using Tuneln Radio.

### Saving/deleting a Tuneln Radio station as a favorite

Multimedia system:

→ Radio ▶  Radio Source  
 ▶▶ Tuneln Radio



- ▶ Select a station.
- ▶ Press and hold the central control element until an audible signal sounds.
- ▶ The  symbol appears by the station name.

- ▶ Select  **Favorites** .
- ▶ The list of saved favorite stations appears.

or

- ▶ Create an account for the online provider (Tuneln Radio) and then log in on the multimedia system.
- ▶ Your favorites are imported to the multimedia system.

### Deleting favorites

- ▶ Select  **Favorites** .
- ▶ Select a station.
- ▶ Press and hold the central control element until an audible signal sounds.
- ▶ The  symbol by the station name disappears.

### Setting the Tuneln Radio options

Multimedia system:

→ Radio ▶  Radio Source  
 ▶▶ Tuneln Radio ▶▶  Options

The following options are available:

- **Select Stream:** select the stream quality

- **Login to Tuneln Account:** log in to your Tuneln user account
- **Log Out of Account:** log out of your Tuneln user account
- ▶ Select an option.

## Media

### Audio mode

#### Information on the audio mode

**⚠ WARNING** Risk of distraction when handling data storage media

If you handle a data storage medium while driving, your attention is diverted from the traffic conditions. This could also cause you to lose control of the vehicle.

- ▶ Only handle a data storage medium when the vehicle is stationary.

Permissible file systems:

- FAT32
- exFAT

- NTFS

Permissible data storage media:

- SD card
- USB storage device
- iPod®/iPhone®
- MTP devices
- Bluetooth® audio device

**i** Observe the following notes:

- The multimedia system supports a total of up to 50,000 files.
- Data storage media up to 2 TB are supported (32-bit address space).

Supported formats:

- MP3
- WMA
- AAC
- WAV
- FLAC
- ALAC

**i** Observe the following notes:

- Due to the large variety of available music files regarding encoders, sampling rates and data transfer rates, playback cannot always be guaranteed.
- Due to the wide range of USB devices available on the market, playback cannot be guaranteed for all USB devices.
- Copy-protected music files or DRM encrypted files cannot be played back.
- MP3 players must support Media Transfer Protocol (MTP).



Manufactured under license from Dolby Laboratories. Dolby, Dolby Audio and the double-D symbol are trademarks of Dolby Laboratories.



Gracenote, the Gracenote logo and logotype, "Powered by Gracenote", MusicID and Playlist Plus are either registered trademarks or trademarks of Gracenote, Inc. in the United States and/or other countries.



"Made for iPod", and "Made for iPhone," mean that an electronic accessory has been designed to connect specifically to iPod®, or iPhone®, respectively, and has been certified by the developer to meet Apple performance standards. Apple® is not responsible for the operation of this device or its compliance with safety and regulatory standards. Please note that the use of this accessory with iPod, or iPhone may affect wireless performance.

**For the USA:** iPhone®, iPod®, iPod classic®, iPod nano®, and iPod touch® are trademarks of Apple Inc., registered in the U.S. and other countries. Lightning® is a trademark of Apple Inc.

**For Canada:** iPhone®, iPod®, iPod classic®, iPod nano®, and iPod touch® are trademarks of Apple Inc., registered in the U.S. and other countries. Lightning® is a trademark of Apple Inc.

#### Notes on copyright

Audio files that you create or reproduce yourself for playback are generally subject to copyright protection. In many countries, reproductions, even for private use, are not permitted without the prior consent of the copyright holder. Make sure

that you know about the applicable copyright regulations and that you comply with these.

#### Activating media mode

Multimedia system:

➔ [Media](#) ➔  [Media Sources](#)

- ▶ Select a media source.  
Playable music files are played back.

#### Inserting/removing an SD card

**⚠ DANGER** Risk of fatal injury from swallowing SD cards

SD cards are small parts.

They could be swallowed and lead to choking.

- ▶ Keep SD cards out of the reach of children.
- ▶ Seek medical attention immediately if an SD card has been swallowed.

**!** **NOTE** Damage due to high temperatures

High temperatures may damage the SD card.

- ▶ Remove the SD card after use and take it out of the vehicle.

Multimedia system:

- ▶ Media ▶  Media Sources
- ▶ Mem. Card

### Inserting

The multimedia connection unit is located in the stowage compartment under the armrest.

- ▶ Insert the SD memory card into the SD card slot until it engages. The side with the contacts must face downwards.  
▶ Playable music files are played back.

### Removing

- ▶ Press the SD card.
- ▶ Remove the SD card.

### Overview of the audio mode

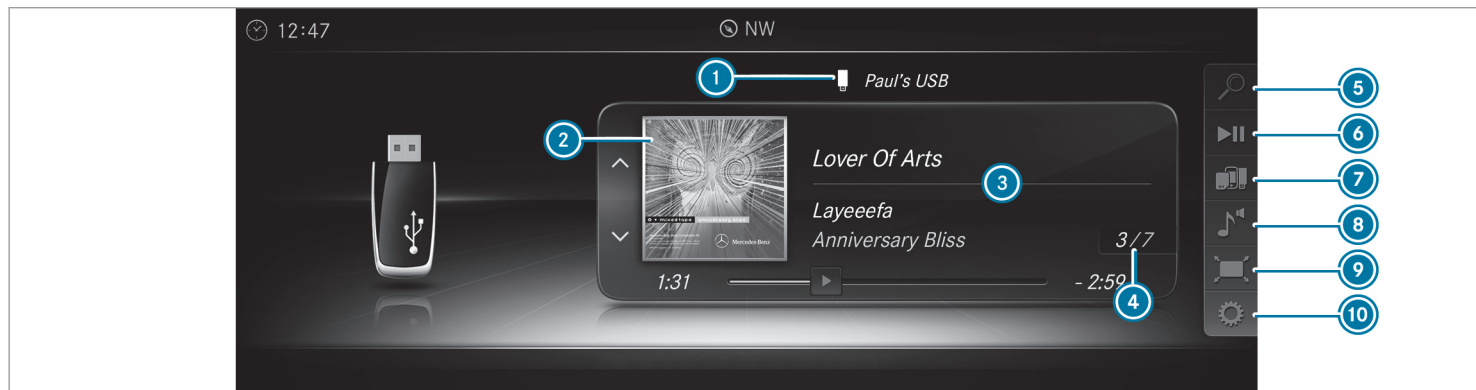

- ① Active data storage medium
- ② Album cover
- ③ Track, artist, album
- ④ Track number and number of tracks in the track list
- ⑤ Search
- ⑥ Playback Control

- ⑦ Media Sources
- ⑧ Sound
- ⑨ Full Screen (for video playback)
- ⑩ Options

### Connecting USB devices

**!** **NOTE** Damage caused by high temperatures

High temperatures can damage USB devices.

▶ Remove the USB device after use and take it out of the vehicle.



The multimedia connection unit is located in the stowage compartment under the armrest and has two USB ports.

Depending on the vehicle's equipment, additional USB ports are located in the center console stowage compartment and in the rear passenger compartment.

- ▶ Connect the USB device to the USB port. Playable music files are played back only if the corresponding media menu is activated.
- ① Use the USB port identified by  to use Apple CarPlay® and Android Auto.
- ① Depending on the vehicle equipment there is an additional USB port in the rear passenger compartment. Ports that are labeled with a battery symbol can only be used to charge USB devices.

### Selecting a track in the media playback

Multimedia system:

↳ **Media**

### Selecting a track by skipping to a track

- ▶ **To skip backwards or forwards to a track:** navigate up or down.

### Selecting a track using the current track list

- ▶ Select .
- ▶ Select **Current Track List**.
- ▶ Select a track.

### Selecting playback options

Multimedia system:

↳ **Media** ▶  **Options**

### Playing back similar tracks

- ▶ Select **Play Similar Tracks**.  
A track list with similar tracks is created and played back.

### Playback mode





- ▶ Select **Random Mode - Current Playlist**.  
The current track list is played in random order.
- ▶ Select **Random Mode - Current Medium**.  
All tracks on the active data storage medium are played in random order.
- ▶ Select **Normal Track Sequence**.  
The current track list is played in the order it appears on the data storage medium.

### Controlling media playback

Multimedia system:

↳ **Media** ▶  **Playback Control**

A bar with playback controls is shown.

- ▶ **To pause playback:** select and confirm  with the central control element. The  symbol is displayed.
- ▶ **To resume playback:** select and confirm  again with the central control element. The  symbol is displayed.

### To fast forward/rewind

- ▶ Move  on the timeline.

### To hide the playback controls

- ▶ Press the  button.

### Video mode

#### Switching to video mode

Multimedia system:

↳ **Media** ▶  **Media Sources**

- ▶ Select a data storage medium.

▶ Search for and select video files or playlists with video files.

Playable video files are played back.

The multimedia system supports the following formats:

- MPEG
- AVI, DivX, MKV
- MP4, M4V
- WMV

ⓘ If the vehicle is traveling faster than 3 mph (5 km/h) the video image is hidden from the driver. If available, the channel and program information is continuously displayed.

Due to the large variety of available video files regarding encoders, sampling rates and data transfer rates, playback cannot be guaranteed.

Videos up to FullHD (1920x1080) are supported.

Copy-protected video files or DRM (Digital Rights Management) encrypted files cannot be played back.

## Overview of video mode

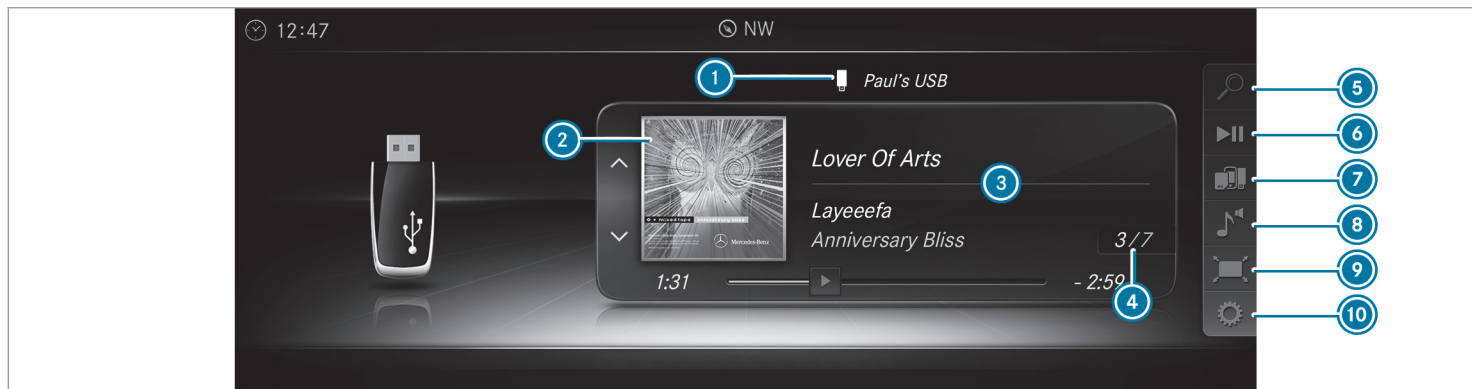

① Active data storage medium

② Album cover

③ Track, artist, album

④ Track number and number of tracks in the track list

⑤ Search

⑥ Playback Control

⑦ Media Sources

⑧ Sound

⑨ Full Screen (for video playback)

⑩ Options

### Activating/deactivating full-screen mode

Multimedia system:

➤ Media ➤ Media Sources

▶ Select a data storage medium.  
Playable video files are played back.

▶ **To activate full-screen mode:** select Full Screen.

- ▶ **To deactivate full-screen mode:** press the touchpad.

### Changing video settings

Multimedia system:

- ▶ **Media** ▶  **Options**
- ▶ **Picture Format**

The following picture formats are available:

- **Automatic**
- **16:9**
- **4:3**
- **Zoom**

- ▶ Select a picture format.

### Adjusting the brightness manually

If the **Automatic** picture format is switched off, you can adjust the brightness yourself.

- ▶ Select **Brightness**.
- ▶ Adjust the brightness.

## Media search

### Starting the media search

Multimedia system:

- ▶ **Media** ▶  **Search**

Depending on the connected media sources and files, the following categories are listed:

- **Current Track List**
- **Keyword Search**
- **Playlists**
- **Artists**
- **Albums**
- **Tracks**
- **Folders**
- **Music Genres**
- **Year**
- **Composers**
- **Videos**
- **Podcasts** (Apple® devices)
- **Audiobooks** (Apple® devices)

- ▶ Select a category.

- ⓘ The categories are available as soon as the entire media content has been read in and analyzed.

## Media Interface

### Information about the Media Interface

Media Interface is a universal interface for the connection of mobile audio equipment. The multimedia system has two USB ports. The USB ports are located in the stowage compartment under the armrest.

### Supported devices

The Media Interface allows you to connect the following data storage media:

- iPod®
- iPhone®
- MP3 player
- USB devices

For details and a list of supported devices, visit our website at <https://www.mercedes-benz.com/connect>. Follow the instructions in the "Media Interface" section.

## Switching to Media Interface

Multimedia system:

Media ► Media Sources

- ▶ Connect a data storage medium to the USB port (→ page 302).
- ▶ Select a media device.  
▶ Playable music files are played back.

## Overview of Media Interface

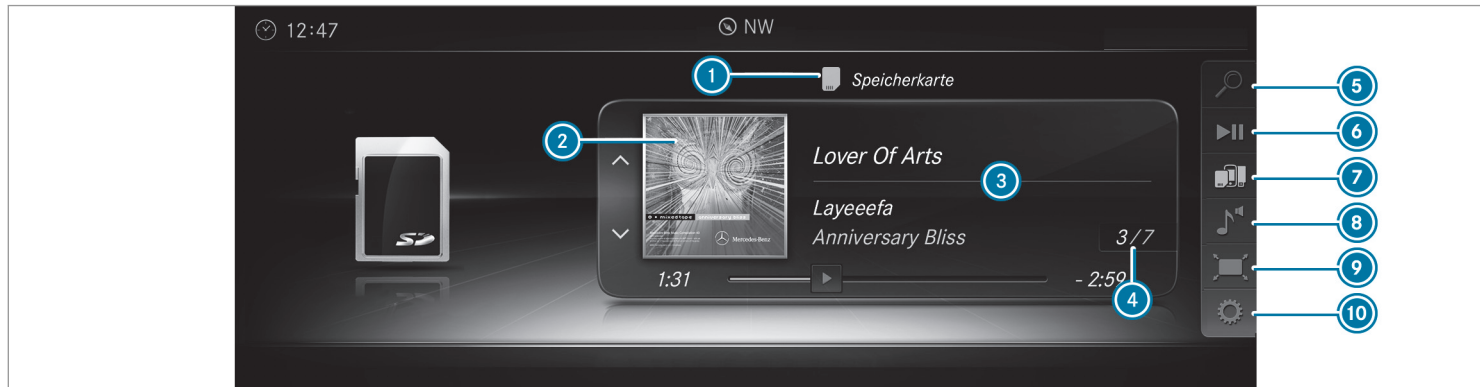

- ① Active data storage medium
- ② Album cover
- ③ Artist, track and album
- ④ Track number and number of tracks in the track list
- ⑤ Search
- ⑥ Playback Control
- ⑦ Media Sources
- ⑧ Sound
- ⑨ Full Screen (video playback only)
- ⑩ Options

### Bluetooth® audio

---

#### Information about Bluetooth® audio

Before using your Bluetooth® audio device with the multimedia system for the first time, you will need to authorize it (→ page 309).

## Bluetooth® audio overview

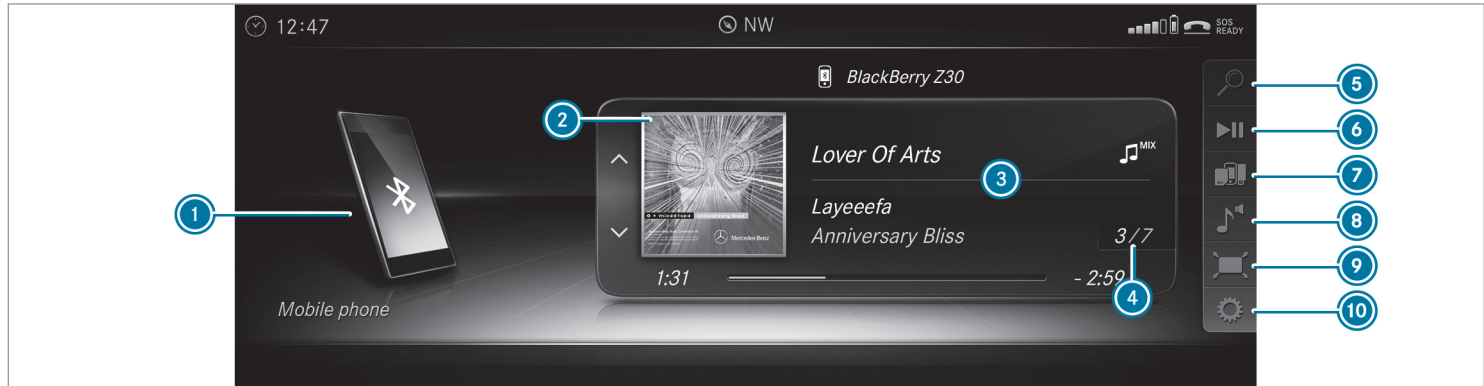

- |   |                                     |
|---|-------------------------------------|
| ① Active data storage medium                          | ⑦ Media Sources                     |
| ② Album cover   | ⑧ Sound                             |
| ③ Track, artist, album                                | ⑨ Full Screen (video playback only) |
| ④ Track number and number of tracks in the track list | ⑩ Options                           |
| ⑤ Search  |                                     |
| ⑥ Playback Control                                    |                                     |

## Searching for and authorizing a Bluetooth® audio device

## Requirements:

- Bluetooth® is activated on the multimedia system and audio equipment (→ page 236).
- The audio equipment supports the Bluetooth® audio profiles A2DP and AVRCP.

- The audio equipment is "visible" for other devices.

Multimedia system:

↳ **Media** ▶  **Media Sources**  
 ▶▶  **Bluetooth Audio**

### Authorizing a new Bluetooth® audio device

- ▶ Select .
- ▶ Select **Add New Bluetooth Audio Device**.
- ▶ Select **Start Search on System**.  
Detected audio equipment is displayed in the device list.
- ▶ Select a Bluetooth® audio device.  
Authorization starts. A code is displayed on the multimedia system and on the mobile phone.
- ▶ If the codes are identical, confirm on the audio equipment.  
The audio equipment is connected and playback starts.

### Selecting previously authorized Bluetooth® audio equipment

- ▶ Select .
- ▶ Select a Bluetooth® audio device.

### Establishing a connection from the Bluetooth® audio equipment

The Bluetooth® device name of the multimedia system is **MB BLUETOOTH XXXXX**.

- ▶ Select **Search from Device**.
- ▶ Start the authorization on the audio equipment (see manufacturer's operating instructions).  
A code is displayed on the multimedia system and on the audio device.
- ▶ Confirm on both devices if the codes are identical.  
The audio equipment is connected and playback starts.

With some audio equipment, playback must be initially started on the device itself so that the multimedia system can play the audio files.

- ⓘ Device-specific information on authorizing and connecting Bluetooth®-capable mobile phones can be obtained at <https://www.mercedes-benz-mobile.com/> or at an authorized Mercedes-Benz Center.

### Activating Bluetooth® audio

Multimedia system:

↳ **Media** ▶  **Media Sources**

- ▶ Select  **Bluetooth Audio**.  
The multimedia system activates the connected Bluetooth® audio equipment.

### Selecting the media player on the Bluetooth® audio device

Multimedia system:

↳ **Media** ▶ 

- ▶ Select the **Bluetooth Audio Players** category.  
If multiple media players are present on the Bluetooth® audio equipment a list appears.
- ▶ Select a media player.  
Playback starts.

- ⓘ The function is not supported by every mobile phone.





### Searching for a music track on the Bluetooth® audio device

Multimedia system:

↳ **Media** ▶  **Media Sources**

▶▶  **Bluetooth Audio**

- ▶ Select .
- ▶ Select a category.  
A track list appears.
- ▶ Select a track.

 The function is only available when the mobile phone and the media player selected on the mobile phone support this function.

### Switching Bluetooth® audio equipment via NFC

#### Requirements:

- Observe the notes on using NFC (→ page 276).
- The Bluetooth® audio overview is displayed (→ page 309).

- ▶ Lightly press the NFC area on the mobile phone (see the manufacturer's operating instructions).  
If the mobile phone has already been authorized on the multimedia system as Bluetooth® audio equipment, it is now connected.  
  
If the mobile phone is authorized on the multimedia system as Bluetooth® audio equipment for the first time, it is connected after confirming the instructions on the mobile phone (see the manufacturer's operating instructions).

### Disconnecting Bluetooth® audio equipment

Multimedia system:

↳ **Phone** ▶▶  **Media Sources**

- ▶ Select the  symbol in the line of the mobile phone.  
The disconnection of the mobile phone takes place without a confirmation prompt. The mobile phone remains authorized in the system.

## Radio

### Switching on the radio

Multimedia system:

↳ **Radio**

- ▶ Alternatively: press the  button.  
The radio display appears. You will hear the last station played on the last frequency band selected.

## Radio overview



- ① Active frequency band
- ② Station name or set frequency
- ③ Artist, title, album and radio text
- ④ Station list
- ⑤ Presets
- ⑥ Radio Source
- ⑦ Sound

⑧ Options

### Switching the HD Radio function on/off

Multimedia system:

→ Radio → ⚙️ Options → HD Radio



- ▶ Switch the function on  or off .

**i** HD Radio Technology manufactured under license from iBiquity Digital Corporation. U.S. and Foreign Patents. HD Radio™ and the HD, HD Radio and "Arc" logos are proprietary trademarks of iBiquity Digital Corp.

### Setting the waveband

Multimedia system:

↳ Radio ▶  Radio Source

HD Radio FM HD Radio AM and SiriusXM Radio can be selected.

- ▶ Select a frequency band.

### Selecting a radio station

Multimedia system:

↳ Radio

- ▶ Navigate up or down.

### Calling up the radio station list

Multimedia system:

↳ Radio ▶

- ▶ Select a station.

### Searching for radio stations using station names or direct frequency entry

Multimedia system:

↳ Radio ▶

- ▶ Enter a station name or frequency.
- ▶ Select  .
- ▶ The search results are displayed.
- ▶ Select a station.

### Storing radio stations

Multimedia system:

↳ Radio ▶  Presets

- ▶ Select **Store Current Station in the Presets.**

### Managing radio station presets

Multimedia system:

↳ Radio ▶  Presets

#### Moving stations:

- ▶ Highlight a preset entry and navigate to the left.
- ▶ Select **Move Highlighted Station.**
- ▶ Select a memory preset.

#### Deleting stations:

- ▶ Highlight a preset entry and navigate to the left.
- ▶ Select **Delete Highlighted Station.**
- ▶ Select **Yes.**

### Activating/deactivating radio text

Multimedia system:

↳ Radio ▶▶  Radio Source

▶▶ Display Radio Text Information

▶ Activate  or deactivate  the function.

### Satellite radio

#### Information on the satellite radio

SIRIUS XM<sup>®</sup> satellite radio offers more than 175 digital-quality radio channels providing 100% commercial-free music, sports, news and entertainment, for example. SIRIUS XM satellite radio employs a fleet of high-performance satellites to broadcast around the clock throughout the USA and Canada. The satellite radio program is available for a monthly fee. Information about this can be obtained from a Sirius XM<sup>®</sup> Service Center and at <https://www.siriusxm.com> (USA) or <https://www.siriusxm.ca> (Canada).

 Sirius, XM and all related marks and logos are trademarks of Sirius XM Radio Inc. and its subsidiaries. All other marks, channel names

and logos are the property of their respective owners. All rights reserved.

#### Satellite radio restrictions

Satellite radio mode may be temporarily unavailable or interrupted for a variety of reasons. These include environmental or topographical conditions beyond the control of Mercedes-Benz USA, LLC. Thus, operation at certain locations may not be possible.

#### Registering satellite radio

##### Requirements:

- Satellite radio equipment
- Registration with a satellite radio provider
- If registration is not included when purchasing the system, your credit card details will be required to activate your account.

Multimedia system:

↳ Radio ▶▶  Radio Source

▶▶ SiriusXM Radio ▶▶  Options

▶ Select **Service Information**.

The service information screen appears showing the radio ID and the current subscription status.

▶ Establish a telephone connection.

▶ Follow the service staff's instructions. The activation process may take up to ten minutes.

 You can also have the satellite service activated online. To do so, please visit <https://www.siriusxm.com> (USA) or <https://www.siriusxm.ca> (Canada).

#### Switching on satellite radio

Multimedia system:

↳ Radio ▶▶  Radio Source

▶ Select **SiriusXM Radio**.

## Overview of the satellite radio

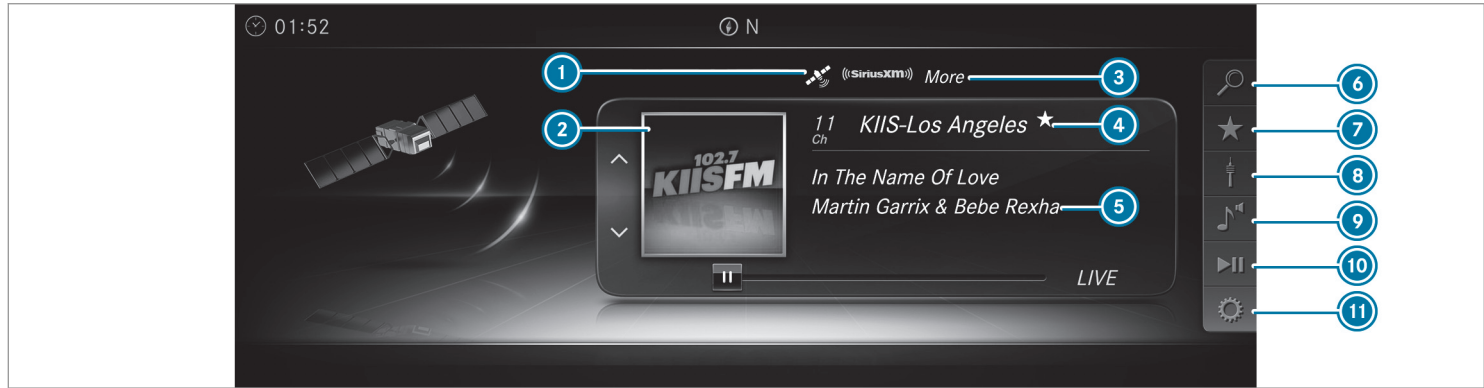

- ① Active frequency band
- ② Logo or cover picture for the song (if available)
- ③ Category
- ④ Channel name
- ⑤ Artist, track and album
- ⑥ SiriusXM Radio Channels

- ⑦ Presets
- ⑧ Radio Source
- ⑨ Sound
- ⑩ Playback Control
- ⑪ Options

**Selecting a satellite radio category**

Multimedia system:

- Radio ➤ Radio Source
- SiriusXM Radio
- SiriusXM Radio Channels ➤ Category
- Select a category.

**Selecting a satellite radio channel**

Multimedia system:

↳ Radio ▶  Radio Source  
 ▶▶ SiriusXM Radio

- ▶ Navigate up or down.

**Saving or deleting a satellite radio channel**

Multimedia system:

↳ Radio ▶  Radio Source  
 ▶▶ SiriusXM Radio ▶▶  Presets

- ▶ Select **Store Current Station in the Presets.**

**Moving a channel**

- ▶ Select **Options.**
- ▶ Select **Move Highlighted Station.**
- ▶ Select a memory preset.

**Deleting a channel**

- ▶ Select **Options.**
- ▶ Select **Delete Highlighted Station.**
- ▶ Select a memory preset.

**Displaying EPG information for the current channel**

Multimedia system:

↳ Radio ▶  Radio Source  
 ▶▶ SiriusXM Radio ▶▶  Options

- ▶ Select **EPG Information about Current Channel.**

**Setting parental control for radio**

Multimedia system:

↳ Radio ▶  Radio Source  
 ▶▶ SiriusXM Radio ▶▶  Options  
 ▶▶ Parental Control

- ▶ Activate the function .
- ▶ Determine a four-digit character sequence and select **ok**.
- ▶ All channels with adult content are locked.

**Unlocking a channel**



- ▶ Enter the four-digit character sequence and select **ok**.
- ▶ All channels with adult content are unlocked.

**Music and sport alerts function**

This function enables you to program an alert for your favorite artists, tracks or sporting events. Music alerts can be saved whilst a track is being played and sport alerts can be saved during a live game. You can also specify sport alerts via the menu option. The system then continuously searches through all the channels. If a match is found with a stored alert, you will be informed.

**Setting music and sport alerts**

Multimedia system:

↳ Radio ▶  Radio Source  
 ▶▶ SiriusXM Radio ▶▶  Options  
 ▶▶ Alert for Artist, Song & Sporting Event

**Setting a music alert**

- ▶ Select **Add New Alert.**

or

- ▶ Select **Manage Artist & Song Alerts.**
- ▶ Select  **Options.**

The following options are available:

- **Mark This Entry**
- **Unmark This Entry**

- [Mark All Entries](#)
- [Unmark All Entries](#)
- [Delete This Entry](#)
- [Delete All Entries](#)

▶ Select an option.

▶ [Activate Artist & Song Alerts](#) .

The alert is set for the current artist or track. If a match is found, a prompt appears asking whether you wish to change to the station.

#### Setting a sport alert

▶ Select [Add New Alert](#).

or

▶ Select [Manage Sports Alerts](#).

▶ Select [Select New Alerts](#).

or

▶ Select [Edit Alerts](#).

▶ Select a team from a league.

▶ [Activate Sports Alerts](#) .

#### Information on Smart Favorites and Tune Start

Stations in the station presets can be added as Smart Favorites. Smart Favorites stations are

automatically saved to temporary storage in the background. If you change to a Smart Favorites station, you can replay, pause or actively skip forward or back to broadcasts which you have missed. If Tune Start is activated and you change to another Smart Favorites station, the music track currently playing on the station is automatically restarted from the beginning of the track.

#### Adding a channel to Smart Favorites

Multimedia system:

↳ [Radio](#) ▶▶  [Radio Source](#)

▶▶ [SiriusXM Radio](#)

▶ Select the active frequency band.

▶ Highlight an entry.

▶ Select .

▶ Select [Add Highlighted Channel to Smart Favorites](#).

#### Activating/deactivating TuneStart

Multimedia system:

↳ [Radio](#) ▶▶  [Options](#) ▶▶ [TuneStart](#)

▶ Activate  or deactivate  the function.

#### Controlling playback

Multimedia system:

↳ [Radio](#) ▶▶  [Playback Control](#)

You can pause the playback of the current station or skip forward or backward in the timeline. This leaves live mode to access the internal temporary storage.

▶ **To fast forward/rewind:** turn the controller counter-clockwise or clockwise/swipe left or right on the touchpad.

▶ **To jump to the previous/next song:** press the controller left or right/swipe left or right on the touchpad.

▶ **To pause playback:** select .

▶ **To return to live mode:** navigate to the end of the timeline.

#### Displaying satellite radio service information

Multimedia system:

↳ [Radio](#) ▶▶  [Radio Source](#)

▶▶ [SiriusXM Radio](#) ▶▶  [Options](#)

▶ Select [Service Information](#).

## Sound

### Tone settings

#### Information about the sound system

The sound system has a total output of 100 W and is equipped with five speakers. It is available for all functions in the radio and media modes.

- ❶ The call can also be made from other audio sources. Replace Media with, for example, Radio in the menu path.

#### Calling up the sound menu

Multimedia system:

↳ Media ▶  Sound

The following functions are available:

- Equalizer
  - Balance and Fader
  - Automatic Volume Adjustment
  - Other Sound Settings
- ▶ Select a sound menu.

#### Adjusting treble, mid-range and bass settings

Multimedia system:

↳ Media ▶  Sound ▶ Equalizer

- ▶ Select **Treble**, **Mid Range** or **Bass**.
- ▶ Change the settings.

#### Activating/deactivating automatic volume adjustment

Multimedia system:

↳ Media ▶  Sound  
▶▶ Automatic Volume Adjustment

Automatic volume adjustment compensates for differing volumes when changing between audio sources.

- ▶ Activate  or deactivate  the function.

#### Adjusting the balance/fader

Multimedia system:

↳ Media ▶  Sound  
▶▶ Balance and Fader

- ▶ Adjust the balance and fader.
- ▶ **To exit the menu:** press the  button.

## Burmester® surround sound system

### Information about the Burmester® surround sound system

The Burmester® surround sound system has a total output of 590 W and is equipped with 13 speakers. It is available for all functions in the radio and media modes.

- ❶ The call can also be made from other audio sources. Replace Media with, for example, Radio in the menu path.

#### Calling up the sound menu in the Burmester® surround sound system

Multimedia system:

↳ Media ▶  Sound

The following functions are available:

- Equalizer
- Balance and Fader
- Automatic Volume Adjustment
- Surround Sound
- Sound Focus
- Other Sound Settings



- ▶ Select a function.

### Adjusting the treble, mid and bass settings on the Burmester® surround sound system

Multimedia system:

↳ Media ▶ Sound ▶ Equalizer

- ▶ Select **Treble**, **Mid Range** or **Bass**.
- ▶ Set the desired values.

### Activating or deactivating volume adjustment in the Burmester® surround sound system

Multimedia system:

↳ Media ▶ Sound  
▶ Automatic Volume Adjustment

Automatic volume adjustment compensates for differing volumes when changing between audio sources.

- ▶ Activate  or deactivate  the function.

### Adjusting the balance/fader in the Burmester® surround sound system

Multimedia system:

↳ Media ▶ Sound  
▶ Balance and Fader

- ▶ Adjust the balance and fader.
- ▶ **To exit the menu:** press the  button.

### Switching surround sound on or off in the Burmester® surround sound system

Multimedia system:

↳ Media ▶ Sound  
▶ Surround Sound

- ▶ Activate  or deactivate  the function.

### Adjusting the sound focus in the Burmester® surround sound system

Multimedia system:

↳ Media ▶ Sound ▶ Sound Focus  
▶ Adjust the sound focus.

## Advanced sound system

### Information about the Advanced sound system

The Advanced sound system has a total output of 225 W and is equipped with nine speakers. It is available for all functions in the radio and media modes.

### Calling up the sound menu in the Advanced sound system

Multimedia system:

↳ Media ▶ Sound

The following functions are available:

- Equalizer
- Balance and Fader
- Automatic Volume Adjustment

- ▶ Select a function.

### Adjusting treble, mid-range and bass settings in the Advanced sound system

Multimedia system:

↳ Media ▶ Sound ▶ Equalizer

- ▶ Select **Treble**, **Mid Range** or **Bass**.
- ▶ Set the desired values.

### Switching the volume adjustment in the Advanced sound system on/off

Multimedia system:

- ↳ Media >>  Sound
- >> Automatic Volume Adjustment

Automatic volume adjustment compensates for differing volumes when changing between audio sources.

- ▶ Activate  or deactivate  the function.

### Setting the balance/fader in the Advanced sound system

Multimedia system:

- ↳ Media >>  Sound
- >> Balance and Fader

- ▶ Adjust the balance and fader.

## ASSYST PLUS service interval display

### Function of the ASSYST PLUS service interval display

The ASSYST PLUS service interval display on the instrument display informs you of the time or distance remaining before the next service due date.

You can hide this service display using the  back button on the steering wheel.

Depending on how the vehicle is used, the ASSYST PLUS service interval display may shorten the service interval, e.g. in the following cases:

- Mainly short-distance driving
- When the engine is often left idling for long periods
- In the event of frequent cold start phases

Mercedes-Benz recommends avoiding such operating conditions.

You can obtain information concerning the servicing of your vehicle from a qualified specialist workshop, e.g. an authorized Mercedes-Benz Center.

### Displaying the service due date

On-board computer:

 Service  ASSYST PLUS

The next service due date is displayed.

 **To exit the display:** press the back button  on the steering wheel.

Bear in mind the following related topic:

- Operating the on-board computer (→ page 207).

### Information on regular maintenance work

 **NOTE** Premature wear through failure to observe service due dates

Maintenance work which is not carried out at the right time or incompletely can lead to increased wear and damage to the vehicle.

 Adhere to the prescribed service intervals.

 Always have the prescribed maintenance work carried out at a qualified specialist workshop.

### Notes on special service requirements

The prescribed service interval is based on normal operation of the vehicle. Have the maintenance work carried out more often than prescribed if operating conditions are difficult or the vehicle is subject to increased stress.

The ASSYST PLUS service interval display is only an aid. It is the responsibility of the driver of the vehicle to have maintenance work carried out more often than prescribed due to actual operating conditions and/or stresses.

Examples of arduous operating conditions:

- Regular city driving with frequent intermediate stops
- Mainly short-distance driving
- Frequent operation in mountainous terrain or on poor road surfaces

- When the engine is often left idling for long periods
- Operation in particularly dusty conditions and/or if air-recirculation mode is frequently used

In these or similar operating conditions, have the interior air filter, air filter, engine oil and oil filter, for example, changed more frequently. If subject to increased stress, check the tires more. Further information can be obtained at a qualified specialist workshop.

### Battery disconnection periods

The ASSYST PLUS service interval display can calculate the service due date only when the battery is connected.

- ▶ Display and note down the service due date on the instrument display before disconnecting the battery (→ page 321).

### Engine compartment

#### Opening and closing the hood

**⚠ WARNING** Risk of accident due to driving with the hood unlocked

The hood may open and block your view.

- ▶ Never release the hood when driving.
- ▶ Before every trip, ensure that the hood is locked.

**⚠ WARNING** Risk of accident and injury when opening and closing the hood

The hood may suddenly drop into the end position.

There is a risk of injury for anyone in the hood's range of movement.

- ▶ Do not open or close the hood if there is a person in the hood's range of movement.

**⚠ WARNING** Risk of burns when opening the hood

If you open the hood in the event of an overheated engine or fire in the engine compartment, the following situations may occur:

- You may come into contact with hot gases.
- You may come into contact with other escaping hot operating fluids.
- ▶ Before opening the hood, allow the engine to cool down.
- ▶ In the event of a fire in the engine compartment, keep the hood closed and call the fire service.

**⚠ WARNING** Risk of injury due to moving parts

Components in the engine compartment may continue to run or start unexpectedly even when the drive system is switched off.

Observe the following if you must open the hood:

- ▶ Switch off the vehicle.
- ▶ Never touch the danger zones surrounding moving components, e.g. the rotation area of the fan.
- ▶ Remove jewellery and watches.
- ▶ Keep items of clothing and hair away from moving parts.

**⚠ WARNING** Risk of injury from touching live components

The ignition system and the fuel injection system operate with a high voltage. You could receive an electric shock.

- ▶ Never touch components of the ignition system or fuel injection system when the vehicle is switched on.

The live components include the following, for example:

- Ignition coils
- Fuel injectors

- Electric lines to the ignition coils and the fuel injectors

**⚠ WARNING** Risk of burns from hot component parts in the engine compartment

Certain component parts in the engine compartment can be very hot, e.g. the engine, the cooler and parts of the exhaust system.

- ▶ Allow the engine to cool down and only touch component parts described in the following.

**⚠ WARNING** Risk of injury from using the windshield wipers when the hood is open

If the windshield wipers start moving when the hood is open, you could be trapped by the wiper linkage.

- ▶ Always switch off the windshield wipers and the vehicle first if you need to open the hood.

### Opens the hood

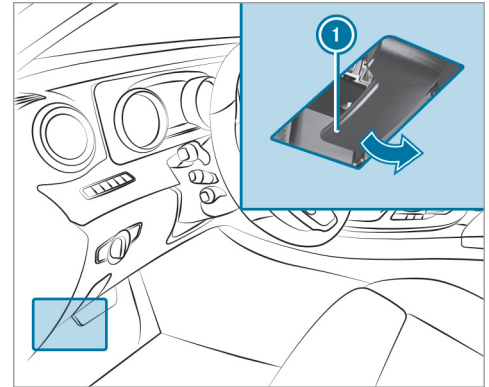

- ▶ To release the hood, pull on handle ①.

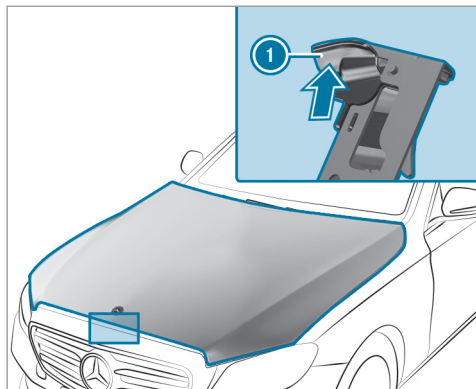

- ▶ Push hood catch handle ① upwards and lift the hood until it opens automatically.

### Closing the hood

- ▶ Lower the hood to a height of approximately 8 in (20 cm) and then allow it to fall, applying a little force as you let it go.

- ▶ If the hood can still be lifted slightly, open the hood again and close it with slightly more force until it engages correctly.

### Engine oil

#### Checking the engine oil level using the oil dipstick

**⚠ WARNING** Risk of burns from hot component parts in the engine compartment

Certain component parts in the engine compartment can be very hot, e.g. the engine, the cooler and parts of the exhaust system.

- ▶ Allow the engine to cool down and only touch component parts described in the following.

#### Requirements

- The engine has an oil dipstick. If not, the engine oil level can be checked only with the on-board computer (→ page 325) .

Depending on the engine, the oil dipstick may be installed in the engine compartment in different locations.

The waiting time before checking the oil level when the engine is at normal operating temperature is five minutes.

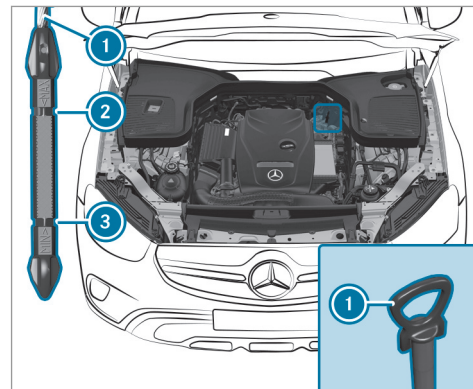

- ▶ Park the vehicle on a level surface.
- ▶ Pull oil dipstick ① out and wipe off.

- ▶ Slowly slide oil dipstick ① into the guide tube to the stop, and pull it out again after approximately three seconds.
  - Oil level is correct: oil level is between ② and ③.
  - Oil level too low: oil level is at ③ or below.
  - Oil level too high: oil level is above ②.
- ▶ If the oil level is too low, add 1.1 US qt (1 liter) of engine oil.
- ▶ If the oil level is too high, drain off excess engine oil. Visit a qualified specialist workshop.

### Checking the engine oil level using the on-board computer

#### Requirements:

- The engine has an oil level sensor. If not, the engine oil level can be checked only with the oil dipstick (→ page 324).
- The engine has been warmed up.
- The vehicle is parked on a level surface.
- The engine is running at idle speed.
- The hood is closed.

The engine oil level is determined during driving. Determining the engine oil level can take up to 30 minutes with a normal driving style and even longer with an active driving style.

On-board computer:

#### → Service ▶▶ Engine Oil Level

One of the following messages will appear on the instrument display:

- **Measuring Engine Oil Level...:** measurement of the oil level is not yet possible.
- ▶ Repeat the request after a maximum of 30 minutes' driving.
- **Engine Oil Level OK** and the bar display for indicating the oil level on the instrument display is green and is between "min" and "max": the oil level is correct.
- **Engine Oil Level Add 1.0 l** and the bar display for indicating the oil level on the instrument display is orange and is below "min":
- ▶ Add 1.1 US qt (1 l) of engine oil.

- **Reduce Engine Oil Level** and the bar display for indicating the oil level on the instrument display is orange and is above "max":
- ▶ Drain off any excess engine oil that has been added. To do so, consult a qualified specialist workshop.
- **For Engine Oil Level Switch Ignition On**
- ▶ Switch on the vehicle to check the engine oil level.
- **Engine Oil Level System Inoperative:** The oil level sensor is defective or not connected.
- ▶ Consult a qualified specialist workshop.
- **Engine Oil Level System Currently Unavail.**
- ▶ Close the hood.

### Adding engine oil

**⚠ WARNING** Risk of burns from hot component parts in the engine compartment

Certain component parts in the engine compartment can be very hot, e.g. the engine, the cooler and parts of the exhaust system.

- ▶ Allow the engine to cool down and only touch component parts described in the following.

**⚠ WARNING** Risk of fire and injury from engine oil

If engine oil comes into contact with hot component parts in the engine compartment, it may ignite.

- ▶ Make sure that no engine oil is spilled next to the filler opening.
- ▶ Allow the engine to cool off and thoroughly clean the engine oil from component parts before starting the vehicle.

**⚠ NOTE** Engine damage caused by an incorrect oil filter, incorrect oil or additives

- ▶ Do not use engine oils or oil filters which do not correspond to the specifications explicitly prescribed for the service intervals.
- ▶ Follow the instructions on the service interval display for changing the engine

oil and observe the prescribed change intervals.

- ▶ Do not use additives.

**⚠ NOTE** Damage caused by refilling too much engine oil

Too much engine oil can damage the engine or the catalytic converter.

- ▶ Have excess engine oil removed at a qualified specialist workshop.

- ⓘ Depending on driving style, the vehicle consumes up to 0.9 US qt (0.8 liter) of oil per 600 miles (1,000 km). The oil consumption may be higher than this when the vehicle is new or if you frequently drive at high engine speeds.

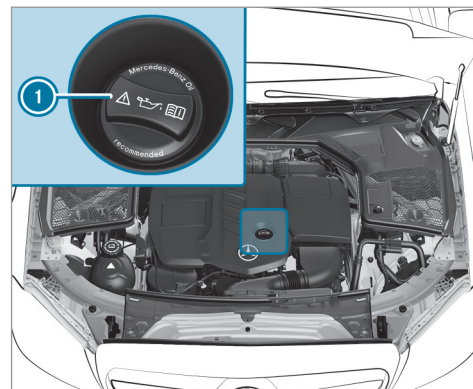

- ▶ Turn cap ① counter-clockwise and remove it.
- ▶ Add engine oil.
- ▶ Replace cap ① and turn it clockwise until it engages.
- ▶ Check the oil level again (→ page 324).



### Checking the coolant level

**⚠ WARNING** Risk of burns from hot component parts in the engine compartment

Certain component parts in the engine compartment can be very hot, e.g. the engine, the cooler and parts of the exhaust system.

▶ Allow the engine to cool down and only touch component parts described in the following.

**⚠ WARNING** Risk of scalding from hot coolant

If you open the cap, you could be scalded.

- ▶ Let the motor cool down before opening the cap.
- ▶ When opening the cap, wear protective gloves and safety glasses.
- ▶ Open the cap slowly to release pressure.

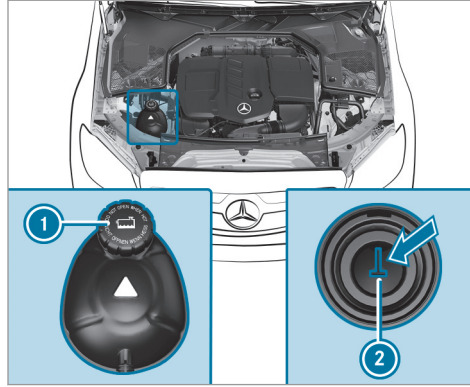

- ▶ Park the vehicle on a level surface.
- ▶ Check the coolant temperature display on the instrument display. The coolant temperature must be in the bottom quarter of the temperature indicator.
- ▶ Slowly turn cap ① counter-clockwise to release overpressure.

▶ Continue turning cap ① counter-clockwise and remove it.

The coolant level is correct in the following cases:

- If the engine is cold, the coolant is up to marker bar ②.
  - If the engine is warm, the coolant is up to 0.6 in (1.5 cm) over the marker bar ②.
- ▶ If necessary, refill with coolant that has been approved for Mercedes-Benz.

① Further information on coolant (→ page 396)

### Adding fluid to the windshield washer system

**⚠ WARNING** Risk of burns from hot component parts in the engine compartment

Certain component parts in the engine compartment can be very hot, e.g. the engine, the cooler and parts of the exhaust system.

▶ Allow the engine to cool down and only touch component parts described in the following.

**⚠ WARNING** – Risk of fire and injury from windshield washer concentrate

Windshield washer concentrate is highly flammable. It could ignite if it comes into contact with hot engine component parts or the exhaust system.

- ▶ Make sure that no windshield washer concentrate spills out next to the filler opening.

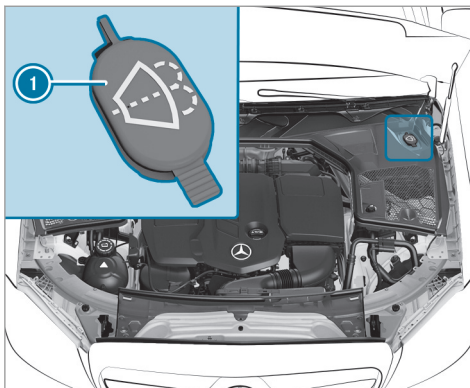

- ▶ Remove cap ① using tab.

- ▶ Add washer fluid.

① Further information on windshield washer fluid (→ page 396)

**Keeping the air/water duct free**

- ▶ Keep the area between the hood and the windshield free of deposits, e.g. ice, snow or leaves.

**Cleaning and care**

**Information on washing the vehicle in a car wash**

**⚠ WARNING** Risk of accident due to reduced braking effect after washing the vehicle

The braking effect is reduced after washing the vehicle.

- ▶ After the vehicle has been washed, brake carefully while paying attention to the traffic conditions until the braking effect has been fully restored.

**!** **NOTE** Damage caused by automatic braking

If one of the following functions is activated, the vehicle brakes automatically in certain situations:

- Active Brake Assist
- Active Distance Assist DISTRONIC
- HOLD function
- Active Parking Assist

To avoid damage to the vehicle, deactivate these systems in the following or similar situations:

- ▶ During towing.
- ▶ In a car wash.

**!** **NOTE** Damage due to unsuitable car wash

- ▶ Before driving into a car wash make sure that the car wash is suitable for the vehicle dimensions.

- ▶ Ensure there is sufficient ground clearance between the underbody and the guide rails of the car wash.
- ▶ Ensure that the clearance width of the car wash, in particular the width of the guide rails, is sufficient.

To avoid damage to your vehicle when using a car wash, ensure the following beforehand:

- Active Distance Assist DISTRONIC is deactivated.
- The HOLD function is switched off.
- The 360° Camera or the reversing camera is switched off.
- The side windows and sliding sunroof are completely closed.
- The blower for the ventilation and heating is switched off.
- The windshield wiper switch is in position **0**.
- The key is at a minimum distance of 10 ft (3 m) away from the vehicle. Otherwise the trunk lid could open unintentionally.
- For car washes with a conveyor system:

- Neutral **N** is engaged.
- If you would like to leave the vehicle while it is being washed, make sure the key is located in the vehicle. Park position **P** is otherwise automatically engaged.

- i** If, after the car wash, you remove the wax from the windshield and wiper rubbers, this will prevent smearing and reduce wiper noise.

#### Information on using a power washer

- !** **WARNING** Risk of an accident when using power washers with round-spray nozzles

The water jet can cause externally invisible damage.

Components damaged in this way may unexpectedly fail.

- ▶ Do not use a power washer with round-spray nozzles.
- ▶ Have damaged tires or chassis parts replaced immediately.

To avoid damage to your vehicle, observe the following when using a power washer:

- The key is at a minimum distance of 10 ft (3 m) away from the vehicle. Otherwise, the trunk lid could open unintentionally.
- Maintain a distance of at least 11.8 in (30 cm) to the vehicle.
- **Vehicles with decorative foil:** parts of your vehicle are covered with a decorative foil. Maintain a distance of at least 27.6 in (70 cm) between the foil-covered parts of the vehicle and the nozzle of the power washer. Move the power washer nozzle around while cleaning. The water temperature of the power washer must not exceed 140 °F (60 °C).
- Observe the information on the correct distance in the equipment manufacturer's operator manual.
- Do not direct the nozzle of the power washer directly at sensitive parts such as tires, gaps, electrical component parts, batteries, illuminants and louvers.

#### Washing the vehicle by hand

**!** **NOTE** Engine damage due to water ingress

▶ Take care not to point the water jet directly towards the air inlet grille below the hood.

Observe the relevant legal requirements (e.g. in some countries, washing by hand is permitted only in specially designated wash bays).

- ▶ Use a mild cleaning agent (e.g. car shampoo).
  - ▶ Wash the vehicle with lukewarm water using a soft car sponge. When doing so, do not expose the vehicle to direct sunlight.
  - ▶ Carefully hose the vehicle off with water and dry using a chamois.
- i** Observe the notes on the care of vehicle parts (→ page 332).

#### Notes on paintwork/matt finish paintwork care

To avoid damaging the paintwork and interfering with the driving assistance systems, please observe the following notes:

#### Paint

- Insect remains: soak with insect remover and rinse off the treated areas afterwards.
- Bird droppings: soak with water and rinse off afterwards.
- Tree resin, oils, fuels and greases: remove by rubbing gently with a cloth soaked in petroleum ether or lighter fluid.
- Coolant and brake fluid: remove with a damp cloth and clean water.
- Tar stains: use tar remover.
- Wax: use silicone remover.
- Do not attach stickers, films or similar materials. Have film attached to the bumper only at a qualified specialist workshop.
- Remove dirt immediately, where possible.

#### Matt finish

- Use only care products approved for Mercedes-Benz.
- Do not attach stickers, films or similar materials. Have film attached to the bumper only at a qualified specialist workshop.

- Do not polish the vehicle and alloy wheels.
- Use only car washes that correspond to the latest engineering standards.
- Do not use any car wash program with a final hot wax treatment.
- Do not use paint cleaners, buffing or polishing products or gloss preservers, e.g. wax.

In the event of paintwork damage:

- Always have paintwork repairs carried out at a qualified specialist workshop.
- Make sure the radar sensors function (→ page 155).

### Notes on cleaning decorative foils

Observe the notes on matte finish care in the "Notes on paintwork/matte finish paintwork care" chapter (→ page 330). They also apply to matte decorative foils.

Observe the notes on cleaning decorative foils to avoid damage.

### Cleaning

- For cleaning, use plenty of water and a mild cleaning agent without additives or abrasive substances (e.g. a car shampoo approved for Mercedes-Benz).
- Remove dirt as soon as possible. Avoid rubbing too hard in order to not irreparably damage the decorative foil.
- If there is dirt on the finish or if the decorative foil is dull: Use the Paint Cleaner recommended and approved for Mercedes-Benz.
- Insect remains: Soak with insect remover and rinse off the treated areas afterwards.
- Bird droppings: Soak with water and rinse off afterwards.
- To prevent water stains, dry a foil-wrapped vehicle with a soft, absorbent cloth after every car wash.

### Avoiding damage to the decorative foil

- The service life and color of decorative foils are impaired by:
  - Sunlight
  - Temperature (e.g. hot air blower)

- Weather conditions
- Stone chippings and dirt
- Chemical cleaning agents
- Oily products
- Do not use polish on matte decorative foil. Polishing will have the effect of shining the foil-wrapped surface.
- Do not treat matte or structured decorative foils with wax. Permanent stains may occur.

Scratches, corrosive deposits, areas affected by corrosion and damage caused by incorrect care cannot always be completely repaired. In this case, contact a qualified specialist workshop.

You can obtain more information on care and cleaning agents from the manufacturer.

In the case of foil-wrapped surfaces, optical differences may occur between the surfaces that were not protected by a decorative foil after removing a decorative foil.

- ① Have work or repairs to decorative foils carried out at a qualified specialist workshop (e.g. in an authorized Mercedes-Benz Service Center).

### Notes on care of vehicle parts

**⚠ WARNING** Risk of entrapment if the windshield wipers are switched on while the windshield is being cleaned

If the windshield wipers are set in motion while you are cleaning the windshield or wiper blades, you can be trapped by the wiper arm.

- ▶ Always switch off the windshield wipers and the vehicle before cleaning the windshield or wiper blades.

**⚠ WARNING** Risk of burns from the tailpipe and tailpipe trims

The exhaust tailpipe and tailpipe trims can become very hot. If you come into contact with these parts of the vehicle, you could burn yourself.

- ▶ Always be particularly careful around the tailpipe and the tailpipe trims and supervise children especially closely in this area.

- ▶ Allow vehicle parts to cool down before touching them.

To avoid damage to the vehicle, observe the notes on cleaning and care of the following vehicle parts:

#### Wheels and rims

- Use water and acid-free alloy wheel cleaners.
- Do not use acidic alloy wheel cleaners to remove brake dust. This could damage wheel bolts and brake components.
- To avoid corrosion of the brake disks and brakepads, drive the vehicle for a few minutes after cleaning before parking it. The brake disks and brakepads warm up and dry out.

#### Windows

- Clean the windows inside and outside with a damp cloth and with a cleaning agent recommended for Mercedes-Benz.
- Do not use dry cloths or abrasive or solvent-based cleaning agents to clean the inside of windows.

- ⓘ After changing the wiper blades or treating the vehicle with wax, clean the windshield thoroughly with cleaning agents recommended for Mercedes-Benz. Failure to observe the application instructions may result in damage, smear marks or glare spots.

- ⓘ Remove external fogging or dirt on the windshield in front of the multifunction camera. Otherwise, driving systems and driving safety systems may be impaired or not available (→ page 155).

#### Wiper blades

- Move the wiper arms into the replacement position (→ page 118).
- With the wiper arms folded out, clean the wiper blades with a damp cloth.
- ⓘ Make sure that the wiper blades are coated. The coating can leave residues on a cloth. Do not rub the wiper blades excessively or clean them too often.

#### Exterior lighting

- Clean the lenses with a wet sponge and mild cleaning agent (e.g. car shampoo).

- Only use cleaning agents or cleaning cloths that are suitable for plastic lenses.

### Sensors

- Clean the sensors in the front and rear passenger compartment bumpers with a soft cloth and car shampoo (→ page 155).
- When using a power washer, maintain a minimum distance of 11.8 in (30 cm).

### Rear view camera and 360° Camera

- Open the camera cover with the multimedia system (→ page 194).
- Use clean water and a soft cloth to clean the camera lens.
- Do not use a power washer.

### Tailpipes

- Clean with a cleaning agent recommended for Mercedes-Benz, especially in the winter and after washing the vehicle.
- Do not use acidic cleaning agents.

### Notes on care of the interior

**⚠ WARNING** Risk of injury from plastic parts breaking off after the use of solvent-based care products

Care and cleaning products containing solvents can cause surfaces in the cockpit to become porous. When the airbags are deployed, plastic parts may break away.

- ▶ Do not use any care or cleaning products containing solvents to clean the cockpit.

**⚠ WARNING** Risk of injury or fatal injuries from bleached seat belts

Bleaching or dyeing seat belts can severely weaken them.

This can, for example, cause seat belts to tear or fail in an accident.

- ▶ Never bleach or dye seat belts.

To avoid damage to the vehicle, observe the following notes on cleaning and care:

### Seat belts

- Clean with lukewarm and soapy water.
- Do not use chemical cleaning agents.
- Do not dry by heating them to over 176 °F (80 °C) or exposing them to direct sunlight.

### Display

- Switch off the display and let it cool down.
- Clean the surface carefully with a microfiber cloth and a suitable display care product (TFT-LCD).
- Do not use any other agents.

### Head-up display

- Clean with a soft, non-static, lint-free cloth.
- Do not use cleaning agents.

### Plastic trim

- Clean with a damp microfiber cloth.
- For heavy soiling: Use a cleaning agent recommended for Mercedes-Benz.
- Do not attach stickers, films or similar materials.

- Do not allow cosmetics, insect repellent or sun cream to come in contact with the plastic trim.

#### Real wood and trim elements

- Clean with a microfiber cloth.
- Black piano-lacquer look: Clean with a damp cloth and soapy water.
- For heavy soiling: Use a cleaning agent recommended for Mercedes-Benz.
- Do not use solvent-based cleaning agents, polishes or waxes.

#### Headliner

- Clean with a brush or dry shampoo.

#### Carpet

- Use a carpet and textile cleaning agent recommended for Mercedes-Benz.

#### Steering wheel made of genuine leather or DINAMICA

**NOTE** Damage caused by wrong cleaners

- ▶ Do not use solvent-based cleaning agents such as tar remover or wheel

cleaner; neither should you use polishes or waxes. Otherwise you may damage the finish.

- Clean with a damp cloth and 1% soapy water solution and then wipe with a dry cloth.
- For heavy soiling: Use a cleaning agent recommended for Mercedes-Benz.
- Leather care: Use a leather care agent that has been recommended for Mercedes-Benz.
- Do not allow the leather to become too damp.
- Do not use a microfiber cloth.

**i** Leather is a natural product. It exhibits natural surface properties such as differences in structure, marks caused by growth and injury or subtle color differences. These surface properties are characteristics of leather and not material defects. What's more, leather is subject to a natural aging process during which the surface properties change.

#### Genuine leather seat covers

- Vacuum away dirt (e.g. crumbs or dust) and then clean the seat covers with a damp cotton

cloth and wipe down with a dry cloth. Regularly clean the seat covers.

- For heavy soiling: use a leather care agent recommended for Mercedes-Benz aftercare.
  - Leather care: Use a leather care agent that has been recommended for Mercedes-Benz.
  - Do not use a microfiber cloth.
  - Do not allow the leather to become too damp.
  - Do not use oil-based cleaning and care products.
- i** Leather is a natural product. It exhibits natural surface properties such as differences in structure, marks caused by growth and injury or subtle color differences. These surface properties are characteristics of leather and not material defects. What's more, leather is subject to a natural aging process during which the surface properties change. Regular cleaning and care of the leather reduces soiling, wear marks and aging damage and thus significantly extends its life span. Clothing that can leave stains (e.g. jeans) can discolor the leather.



**DINAMICA seat covers**

- Clean with a damp cloth.
- Do not use a microfiber cloth.

**Imitation leather seat covers**

- Vacuum up dirt such as crumbs or dust and then use a damp cotton cloth and a 1% soap-suds solution to clean the entire seat cover. Do not spot clean.
- Use cleaning and care products recommended for Mercedes-Benz.
- Do not use a microfiber cloth.
- Do not use oil-based cleaning and care products.

**Fabric seat covers**

- Vacuum up dirt such as crumbs or dust and then use a damp microfiber cloth and a 1% soapsuds solution to clean the entire seat cover. Do not spot clean.
- Use cleaning and care products recommended for Mercedes-Benz.
- Do not use oil-based cleaning and care products.

## Emergency

### Removing the safety vest

The safety vests are located in the stowage compartments in the driver and front passenger door.

- ▶ **To remove:** pull out safety vest bag by loop.
- ▶ Open the safety vest bag and pull out the safety vest.

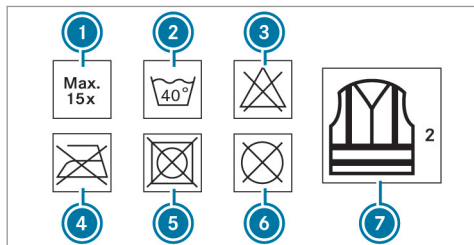

- ① Maximum number of washes
- ② Maximum wash temperature
- ③ Do not bleach
- ④ Do not iron
- ⑤ Do not tumble dry

- ⑥ Do not dry clean
- ⑦ Class 2 safety vest

The requirements defined by the legal standard are only fulfilled if the safety vest is the correct size and is fully closed.

The safety vest must be replaced in the following situations:

- The reflective strips are damaged or dirty
- The maximum permissible number of washes is exceeded
- The fluorescence has faded

## Warning triangle

### Removing the warning triangle

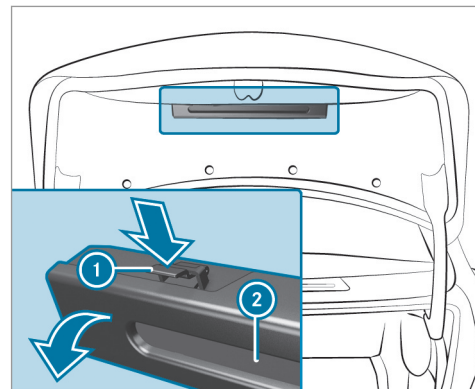

- ▶ Push both sides of warning triangle holder ① in the direction of the arrow and open it.
- ▶ Remove warning triangle ②.

### Setting up the warning triangle

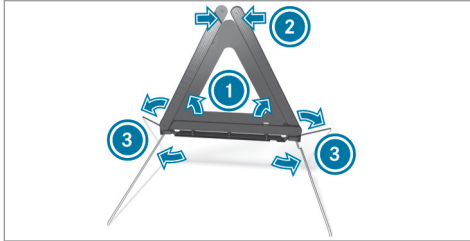

- ▶ Fold side reflectors ① upwards to form a triangle and attach at the top using upper press-stud ②.
- ▶ Fold legs ③ down and out to the side.

### First-aid kit (soft sided) overview

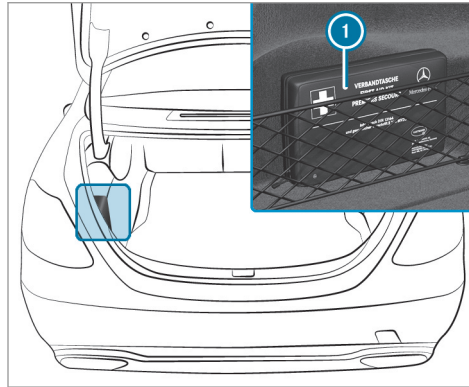

First-aid kit (soft sided) ① is on the left or right in the trunk, depending on the vehicle version.

### Flat tire

#### Notes on flat tires

**⚠ WARNING** Risk of accident due to a flat tire

A flat tire severely affects the driving characteristics as well as the steering and braking of the vehicle.

#### Tires without run-flat characteristics:

- ▶ Do not drive with a flat tire.
- ▶ Change the flat tire immediately with an emergency spare wheel or spare wheel. Alternatively, consult a qualified specialist workshop.

#### Tires with run-flat characteristics:

- ▶ Observe the information and warning notes on MOExtended tires (run-flat tires).

In the event of a flat tire, the following options are available depending on your vehicle's equipment:

- **Vehicles with MOExtended tires:** it is possible to continue the journey for a short period of time. Make sure you observe the notes on MOExtended tires (run-flat tire) (→ page 338).
  - **Vehicles with a TIREFIT kit:** you can repair the tire so that it is possible to continue the journey for a short period of time. To do this, use the TIREFIT kit (→ page 339).
  - **Vehicles with Mercedes me connect:** you can make a call for breakdown assistance via the overhead control panel in the case of a breakdown (→ page 288).
  - **All vehicles:** change the wheel (→ page 380).
-  The emergency spare wheel is available only in certain countries.

### Notes on MOExtended tires (run-flat tires)

 **WARNING** Risk of accident when driving in limp-home mode

When driving in emergency mode the handling characteristics are impaired.

- ▶ Do not exceed the specified maximum speed of the MOExtended tires.
- ▶ Avoid any abrupt steering and driving maneuvers as well as driving over obstacles (curbs, pot holes, off-road). This applies, in particular, to a loaded vehicle.
- ▶ Stop driving in the emergency mode if you notice:
  - Banging noise
  - Vehicle vibration
  - Smoke which smells like rubber
  - Continuous ESP® intervention
  - Cracks in the tire side walls
- ▶ After driving in emergency mode, have the rims checked by a qualified specialist

workshop with regard to their further use.

- ▶ The defective tire must be replaced in every case.

With MOExtended tires (run-flat tires), you can continue to drive your vehicle even if there is a total loss of pressure in one or more tires. However, the affected tire must not show signs of clearly visible damage.

You can recognize MOExtended tires by the MOExtended marking which appears on the side wall of the tire.

**Vehicles with a tire pressure loss warning system:** MOExtended tires may only be used in conjunction with an activated tire pressure loss warning system.

**Vehicles with a tire pressure monitoring system:** MOExtended tires may only be used in conjunction with an activated tire pressure monitoring system.

If a pressure loss warning message appears in the driver's display, proceed as follows:

- Check the tire for damage.

- If driving on, observe the following notes.

#### Driving distance possible in emergency mode after the pressure loss warning:

Load condition	Driving distance possible in emergency mode
Partially laden	50 miles (80 km)
Fully laden	19 miles (30 km)

The driving distance possible in emergency mode may vary depending on the driving style. Observe the maximum permissible speed of 50 mph (80 km/h).

If a tire has gone flat and cannot be replaced with an MOExtended tire, you can use a standard tire as a temporary measure.

#### TIREFIT kit storage location

The TIREFIT kit is located under the trunk floor.

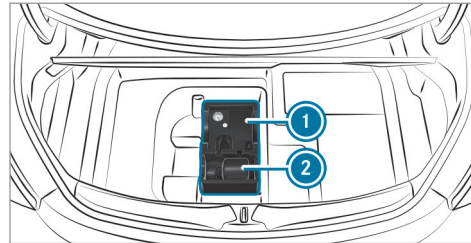

- ① Tire inflation compressor
- ② Tire sealant bottle

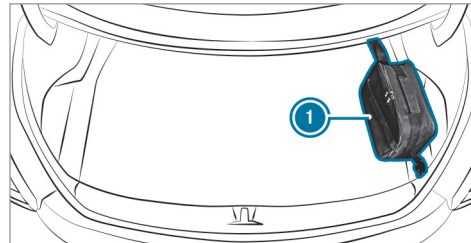

- ① Bag

Depending on the model, the TIREFIT kit may also be located in other places under the cargo floor or in bag ① in the trunk.

#### Using the TIREFIT kit

##### Requirements

- Tire sealant bottle
- TIREFIT sticker
- Tire inflation compressor
- Gloves (depending on the vehicle equipment)

TIREFIT kit storage location: (→ page 339)

You can use TIREFIT tire sealant to seal perforation damage of up to 0.16 in (4 mm), particularly those in the tire contact surface. You can use TIREFIT in outside temperatures down to -4 °F (-20 °C).

**⚠ WARNING** Risk of accident when using tire sealant

The tire sealant may be unable to seal the tire properly, especially in the following cases:

- There are large cuts or punctures in the tire (larger than damage previously mentioned)
  - The wheel rims have been damaged
  - After journeys with very low tire pressure or with flat tires
- ▶ Do not continue driving.
  - ▶ Consult a qualified specialist workshop.

**⚠ WARNING** Risk of injury and poisoning from tire sealant

The tire sealant is harmful and causes irritation. Do not allow it to come into contact with the skin, eyes or clothing, and do not swallow it. Do not inhale tire sealant fumes. Keep the tire sealant away from children.

If you come into contact with the tire sealant, observe the following:

- ▶ Rinse off the tire sealant from your skin immediately using water.

- ▶ If tire sealant gets into your eyes, thoroughly rinse out the eyes using clean water.
- ▶ If tire sealant has been swallowed, immediately rinse out the mouth thoroughly and drink plenty of water. Do not induce vomiting and seek medical attention immediately.
- ▶ Change out of any clothes contaminated with tire sealant immediately.
- ▶ If allergic reactions occur, seek medical attention immediately.

**! NOTE** Overheating due to the tire inflation compressor running too long

- ▶ Do not run the tire inflation compressor for longer than ten minutes without interruption.

Comply with the manufacturer's safety notes on the sticker on the tire inflation compressor.

Have the tire sealant bottle replaced in a qualified specialist workshop every five years.

- ▶ Do not remove any foreign objects that have penetrated the tire.

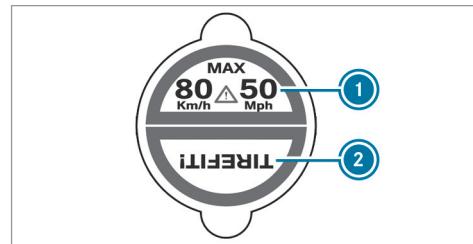

- ▶ Affix part ① of the TIREFIT sticker to the instrument cluster within the driver's field of vision.
- ▶ Affix part ② of the TIREFIT sticker near the valve on the wheel with the defective tire.

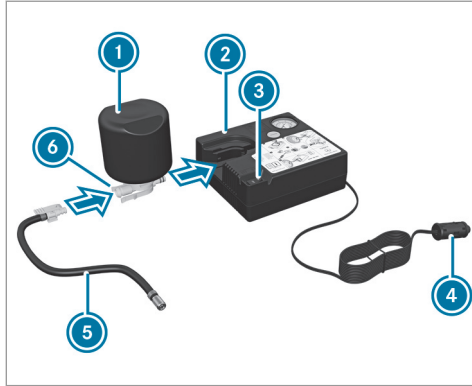

- ▶ Pull plug 4 with the cable and hose 5 out of the tire inflation compressor housing.
- ▶ Push the plug of hose 5 into flange 6 of tire sealant bottle 1 until the plug engages.
- ▶ Place tire sealant bottle 1 head downwards into recess 2 of the tire inflation compressor.

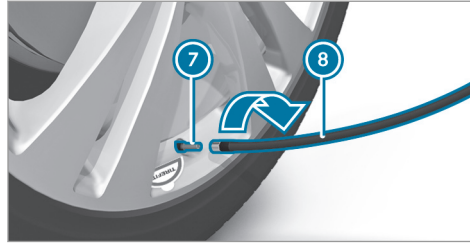

- ▶ Remove the cap from valve 7 on the faulty tire.
- ▶ Screw filling hose 8 onto valve 7.
- ▶ Insert plug 4 into a 12-V-socket in your vehicle.
- ▶ Switch on the vehicle.
- ▶ Press on and off switch 3 on the tire inflation compressor.  
The tire inflation compressor is switched on. The tire is inflated. First, tire sealant is pumped into the tire. The pressure may briefly rise to approximately 500 kPa (5 bar/73 psi).

### Do not switch off the tire inflation compressor during this phase!

- ▶ Let the tire inflation compressor run for a maximum of ten minutes.  
The tire should then have attained a tire pressure of at least 200 kPa (2.0 bar/29 psi).

If tire sealant leaks out, make sure you clean the affected area as quickly as possible. It is preferable to use clean water.

If you get tire sealant on your clothing, have it cleaned as soon as possible with perchloroethylene.

### If a tire pressure of 200 kPa (2.0 bar/29 psi) has not been attained after ten minutes:

- ▶ Switch off the tire inflation compressor.
- ▶ Unscrew the filling hose from the valve of the defective tire.

Please note that tire sealant may leak out when unscrewing the filling hose.

- ▶ Very slowly drive forwards or reverse approximately 33 ft (10 m).

- ▶ Pump up the tire again.  
After a maximum of ten minutes the tire pressure must be at least 200 kPa (2.0 bar/29 psi).

**⚠ WARNING** Risk of accident due to the specified tire pressure not being achieved

If the specified tire pressure is not achieved after the specified time, the tire is too badly damaged. The tire sealant cannot repair the tire in this instance.

The braking characteristics as well as the driving characteristics may be greatly impaired.

- ▶ Do not continue driving.
- ▶ Consult a qualified specialist workshop.

**If a tire pressure of 200 kPa (2.0 bar/29 psi) has been attained after ten minutes:**

**⚠ WARNING** Risk of accident from driving with sealed tires

A tire temporarily sealed with tire sealant impairs the handling characteristics and is not suitable for higher speeds.

- ▶ Adapt your driving style accordingly and drive carefully.
- ▶ Do not exceed the maximum speed limit with a tire that has been repaired using tire sealant.

- ▶ Observe the maximum permissible speed for a tire sealed with tire sealant 50 mph (80 km/h).
- ▶ Affix the upper section of the TIREFIT sticker to the instrument cluster in a location where it will be easily seen by the driver.

**! NOTE** Staining caused by leaking tire sealant

After use, excess tire sealant may leak out from the filling hose.

- ▶ Therefore, place the filling hose in the plastic bag that contained the TIREFIT kit.

**🔥 ENVIRONMENTAL NOTE** Environmental pollution caused by environmentally irresponsible disposal

Tire sealant contains pollutants.

- ▶ Have the tire sealant bottle disposed of professionally, e.g. at an authorized Mercedes-Benz Center.
- ▶ Switch off the tire inflation compressor.
- ▶ Unscrew the filling hose from the valve of the defective tire.
- ▶ Stow the tire sealant bottle and the tire inflation compressor.
- ▶ **Pull away immediately.**
- ▶ Stop driving after approximately ten minutes and check the tire pressure using the tire inflation compressor.  
The tire pressure must now be at least 130 kPa (1.3 bar/19 psi).



**⚠ WARNING** Risk of accident due to the specified tire pressure not being attained

If the specified tire pressure is not reached, the tire is too badly damaged. The tire sealant cannot repair the tire in this instance.

The braking and driving characteristics may be greatly impaired.

- ▶ Do not continue driving.
- ▶ Consult a qualified specialist workshop.

In cases such as the one mentioned above, contact an authorized Mercedes-Benz Center. Or call 1-800-FOR-MERCEdes (in the USA) or 1-800-387-0100 (in Canada).

- ▶ Correct the tire pressure if it is still at least 130 kPa (1.3 bar/19 psi). See the Tire and Loading Information placard on the B-pillar on the driver's side or the tire pressure table in the fuel filler flap for values.
- ▶ **To increase the tire pressure:** switch on the tire inflation compressor.

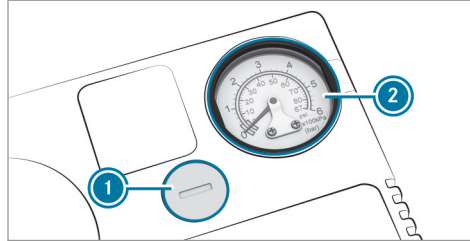

- ▶ **To reduce the tire pressure:** press pressure release button ① next to manometer ②.
- ▶ When the tire pressure is correct, unscrew the filling hose from the valve of the sealed tire.
- ▶ Screw the valve cap onto the valve of the sealed tire.

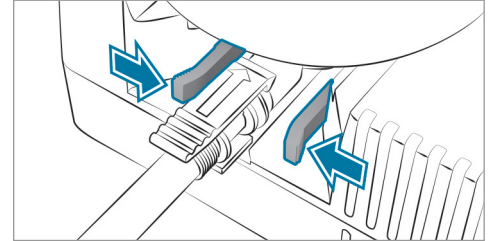

- ▶ Pull the tire sealant bottle out of the tire inflation compressor. Press the locking tabs on the yellow cap together to do this. The filling hose stays on the tire sealant bottle.
- ▶ Drive to the nearest qualified specialist workshop and have the tire, tire sealant bottle and filling hose replaced there.

**Battery (vehicle)****Notes on the 12 V battery**

**⚠ WARNING** Risk of an accident due to work carried out incorrectly on the battery

Work carried out incorrectly on the battery can, for example, lead to a short circuit. This can restrict functions relevant for safety systems and impair the operating safety of your vehicle.

You could lose control of the vehicle in the following situations in particular:

- When braking
  - In the event of abrupt steering maneuvers and/or when the vehicle's speed is not adapted to the road conditions
- ▶ In the event of a short circuit or a similar incident, contact a qualified specialist workshop immediately.
- ▶ Do not drive on.
- ▶ Always have work on the battery carried out at a qualified specialist workshop.

- Further information on ABS (→ page 157)
- Further information on ESP®

For safety reasons, Mercedes-Benz recommends that you only use batteries which have been approved for your vehicle by Mercedes-Benz.

**All vehicles except vehicles with a lithium-ion battery**

**⚠ WARNING** Risk of explosion due to electrostatic charge

Electrostatic charge can ignite the highly explosive gas mixture in the battery.

- ▶ To discharge any electrostatic charge that may have built up, touch the metal vehicle body before handling the battery.

The highly flammable gas mixture is created while the battery is charging and during starting assistance.

**⚠ WARNING** Danger of chemical burns from the battery acid

Battery acid is caustic.

- ▶ Avoid contact with the skin, eyes or clothing.
- ▶ Do not lean over the battery.
- ▶ Do not inhale battery gases.
- ▶ Keep children away from the battery.
- ▶ Immediately rinse battery acid off thoroughly with plenty of clean water and seek medical attention immediately.

**All vehicles**

**ENVIRONMENTAL NOTE** Environmental damage due to improper disposal of batteries



Batteries contain pollutants. It is illegal to dispose of them with the household rubbish.



Dispose of batteries in an environmentally responsible manner. Take discharged batteries to a qualified specialist workshop or to a collection point for used batteries.

If you have to disconnect the 12 V battery, contact a qualified specialist workshop.

Comply with safety notes and take protective measures when handling batteries.



Risk of explosion.



Fire, naked flames and smoking are prohibited when handling the battery. Avoid creating sparks.



Electrolyte or battery acid is corrosive. Avoid contact with the skin, eyes or clothing. Wear suitable protective clothing, in particular gloves, an apron

and a face mask. Immediately rinse electrolyte or acid splashes off with clean water. Consult a doctor if necessary.



Wear safety glasses.



Keep children away.



Observe this Operator's Manual.

Observe the following if you do not intend to use the vehicle over an extended period of time:

- Activate standby mode.
- Alternatively: connect the battery to a battery charger approved by Mercedes-Benz or consult a qualified specialist workshop to disconnect the battery.

## Notes on starting assistance and charging the 12 V battery

### All vehicles

When charging the battery and during starting assistance, always use the jump-start connection point in the engine compartment.

**!** **NOTE** Damage to the battery due to over-voltage

When charging using a battery charger without a maximum charging voltage, the battery or the on-board electronics may be damaged.

► Only use battery chargers with a maximum charging voltage of 14.8 V.

**!** **WARNING** Risk of explosion due to the ignition of hydrogen gas

If there is a short circuit or sparks are created, there is a danger of hydrogen gas igniting when you charge the battery.

- ▶ Make sure that the POSITIVE terminal of a connected battery does not come into contact with vehicle parts.
- ▶ Never place metal objects or tools on a battery.
- ▶ When connecting and disconnecting the battery, always observe the sequence of battery terminals described.
- ▶ During starting assistance, always take care to connect only battery terminals of identical polarity.
- ▶ During starting assistance, observe the sequence described for connecting and disconnecting the jumper cables.
- ▶ Do not connect or disconnect the battery terminals with the engine running.

**⚠ WARNING** Risk of explosion due to a mixture of explosive gases

A mixture of explosive gases can escape from the battery during charging and jump starting.

- ▶ Fire, open flames, smoking and creating sparks must be avoided.
- ▶ Make sure that there is sufficient ventilation.
- ▶ Do not stand over the battery.

**⚠ WARNING** Risk of explosion from a frozen battery

- A discharged battery may freeze at temperatures slightly above or below freezing point.
- During starting assistance or battery charging, battery gas can be released.
- ▶ Always allow a battery to thaw before charging it or performing starting assistance.

If the indicator/warning lamps in the instrument cluster do not light up at low temperatures, it is very likely that the discharged battery has frozen. In this case you may neither jump-start the vehicle nor charge the battery.

The service life of a battery that has been thawed may be dramatically shortened. The starting char-

acteristics may be impaired, especially at low temperatures.

It is recommended that you have a thawed battery checked at a qualified specialist workshop.

#### All vehicles

**!** **NOTE** Damage caused by numerous or extended attempts to start the engine

Numerous or extended attempts to start the engine may damage the catalytic converter due to non-combusted fuel.

- ▶ Avoid numerous and extended attempts to start the engine.

Observe the following points during starting assistance and when charging the battery:

- Only use undamaged jumper cable/charging cables with a sufficient cross-section and insulated terminal clamps.
- Non-insulated parts of the terminal clamps must not come into contact with other metal parts while the jumper cable/charging cable

is connected to the battery/jump-start connection point.

- The jumper cable/charging cable must not come into contact with any parts which may move when the engine is running.
- Always make sure that neither you nor the battery is electrostatically charged.
- Keep away from fire and naked flames.
- Do not lean over the battery.

Observe the additional following points when charging the battery:

- Only use battery chargers tested and approved for Mercedes-Benz.
- Read the battery charger's operating instructions before charging the battery.

Observe the additional following points during starting assistance:

- Starting assistance may only be provided using vehicles, batteries or other jump start devices with a nominal voltage of 12 V.
- The vehicles must not touch.

- **Vehicles with a gasoline engine:** jump-start the vehicle only when the engine and exhaust system are cold.

### Starting assistance and charging the 12 V battery

#### Preparing starting assistance/charging

- ▶ Secure the vehicle by applying the electric parking brake.
- ▶ **Automatic transmission:** shift the transmission to position **P**.
- ▶ **Manual transmission:** shift the transmission to neutral.
- ▶ Switch off the vehicle and all electrical consumers.
- ▶ Open the hood.

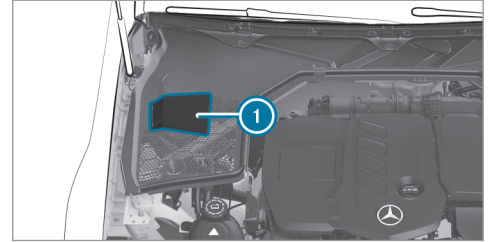

Example illustrations

- ▶ Open cover ① of the jump-starting connection points.

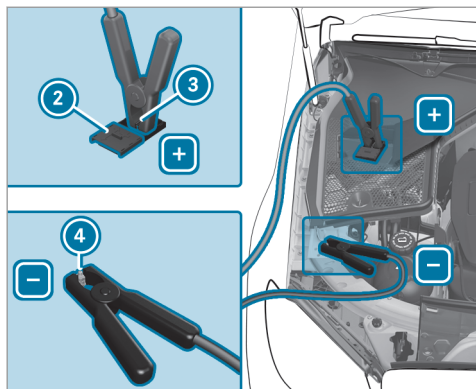

- ▶ Open cover ② of positive contact ③ of the jump-starting connection points.

### Starting assistance

- ▶ Connect positive contact ③ on your vehicle to the positive terminal of the donor battery using the jumper cable. Always begin with positive clamp ③ on your own vehicle first.

- ▶ Start the engine of the donor vehicle and run it at idling speed.
- ▶ Connect the negative terminal of the donor battery to ground point ④ of your vehicle using the jumper cable. Begin with the donor battery first.
- ▶ Start the engine of your own vehicle.
- ▶ Let the engines run for several minutes.
- ▶ Before disconnecting the jumper cables, switch on an electrical consumer in your own vehicle, e.g. the rear window heater defroster or the lighting.

When the starting assistance procedure is complete:

- ▶ First, remove the jumper cables from ground point ④ and the negative terminal of the donor battery, then from positive contact ③ and the positive terminal of the donor battery. Begin each time with the contacts on your own vehicle first.
- ▶ After removing the jumper cables, close cover ② of positive contact ③.

- ▶ Close cover ①.

Further information can be obtained at a qualified specialist workshop.

### Charging

- ▶ Connect positive contact ③ of the vehicle to the positive terminal of the charger using the charging cable. Always begin with positive contact ③ of the vehicle.
- ▶ Connect the negative terminal of the charger and ground point ④ on the vehicle with the charging cable. Start with the charger.
- ▶ Start the charging process.

When the charging process is complete:

- ▶ First, remove the charging cable from ground point ④ and the negative terminal of the charger, then from positive contact ③ and the positive terminal of the charger. Begin each time with the contacts of the vehicle.
- ▶ After removing the charging cable, close cover ② of positive contact ③.
- ▶ Close cover ①.

Further information can be obtained at a qualified specialist workshop.

### Replacing the 12 V battery

- ▶ Observe the notes on the 12 V battery (→ page 344).

Mercedes-Benz recommends that you have the 12 V battery replaced at a qualified specialist workshop, e.g. at an authorized Mercedes-Benz Center.

Observe the following notes if you want to replace the battery yourself:

- Always replace a faulty battery with a battery which meets the specific vehicle requirements.

The vehicle is equipped with an AGM technology battery (Absorbent Glass Mat) or a lithium-ion battery. Full vehicle functionality is only guaranteed with an AGM battery or lithium-ion battery. For safety reasons, Mercedes-Benz recommends that you only use batteries which have been tested and approved for your vehicle by Mercedes-Benz.

- Carry over detachable parts, such as vent hoses, elbow installing or terminal covers from the battery being replaced.
- Make sure that the vent hose is always connected to the original opening on the side of the battery.  
Install any existing or supplied cell caps.  
Otherwise, gases or battery acid could escape.
- Make sure that detachable parts are reconnected in the same way.

### Tow starting or towing away

#### Permitted towing methods

#### ! NOTE Damage from automatic braking

If one of the following functions is activated, the vehicle brakes automatically in certain situations:

- Active Brake Assist
- Active Distance Assist DISTRONIC

- HOLD function
- Active Parking Assist

To avoid damage to the vehicle, deactivate these systems in the following or similar situations:

- ▶ During towing
- ▶ In a car wash

Mercedes-Benz recommends transporting your vehicle in the case of a breakdown, rather than towing it away.

For towing, use a tow rope or tow bar with both axles on the ground. Do not use tow bar systems.

#### ! NOTE Damage to the vehicle due to towing away incorrectly

- ▶ Observe the instructions and notes on towing away.

**Vehicles with automatic transmission****Permitted towing methods**

Both axles on the ground	Yes, maximum 31 miles (50 km) at 31 mph (50 km/h)
Front axle raised	No
Rear axle raised	Yes, if the steering wheel is fixed in the center position with a steering wheel lock

**4MATIC vehicles****Permitted towing methods**

Both axles on the ground	Yes, maximum 31 miles (50 km) at 31 mph (50 km/h)
Front axle raised	No
Rear axle raised	No

**Towing with a raised axle:** towing should be performed by a towing company.

**Towing the vehicle with both axles on the ground**

- ▶ Observe the notes on the permitted towing methods.
- ▶ Make sure that the battery is connected and charged.

Observe the following points when the battery is discharged:

- The vehicle cannot be started.
- the electric parking brake cannot be released or applied
- **Vehicles with automatic transmission:** The transmission cannot be shifted to position **[N]** or **[P]**.

**i** **Vehicles with automatic transmission:** If the transmission cannot be shifted to position **[N]** or if the display does not show anything, transport the vehicle (→ page 351). A towing vehicle with lifting equipment is required for vehicle transportation.

**!** **NOTE** Damage due to towing away at excessively high speeds or over long distances

The drivetrain could be damaged when towing at excessively high speeds or over long distances.

- ▶ A towing speed of 30 mph (50 km/h) must not be exceeded.
- ▶ A towing distance of 30 miles (50 km) must not be exceeded.

**!** **WARNING** Risk of accident when towing a vehicle which is too heavy

If the vehicle to be tow-started or towed away is heavier than the permissible gross mass of your vehicle, the following situations can occur:

- The towing eye may become detached.
- The vehicle/trailer combination may swerve or rollover.
- ▶ Before tow-starting or towing away, check if the vehicle to be tow-started or



towed away exceeds the permissible gross mass.

If a vehicle must be tow-started or towed away, its permissible gross mass must not exceed the permissible gross mass of the towing vehicle.

- ▶ Information on the permissible gross mass of the vehicle can be found on the vehicle identification plate (→ page 390).
- ▶ **Vehicles with automatic transmission:** Do not open the driver's door or front passenger door; the transmission otherwise automatically shifts to position **P**.
- ▶ Install the towing eye (→ page 353).
- ▶ Fasten the towing device.

**!** **NOTE** Damage due to incorrect connection of the tow bar

- ▶ Only connect the tow rope or tow bar to the towing eyes.

- ▶ Deactivate the automatic locking mechanism (→ page 69).

- ▶ Do not activate the HOLD function.
- ▶ Deactivate the tow-away alarm (→ page 84).
- ▶ Deactivate Active Brake Assist (→ page 179).
- ▶ **Vehicles with automatic transmission:** Shift to position **N**.
- ▶ Release the electric parking brake.

**!** **WARNING** Risk of accident due to limited safety-related functions during the towing process

Safety-related functions are limited or no longer available in the following situations:

- The vehicle is switched off.
- The brake system or power steering system is malfunctioning.
- The energy supply or the on-board electrical system is malfunctioning.

When your vehicle is towed away, significantly more effort may be required to steer and brake than is normally required.

- ▶ Use a tow bar.

- ▶ Make sure that the steering wheel can move freely before towing the vehicle away.

**!** **NOTE** Damage due to excessive tractive power

If you pull away sharply, the tractive power may be too high and the vehicles could be damaged.

- ▶ Pull away slowly and smoothly.

### Loading the vehicle for transport

- ▶ Observe the notes on towing away (→ page 350).
- ▶ Fasten the towing device to the towing eye in order to load the vehicle.
- ▶ **Vehicles with automatic transmission:** shift the automatic transmission to position **N**.

**i Vehicles with automatic transmission:** the automatic transmission may be locked in position **[P]** in the event of damage to the electrical system. To shift to **[N]**, supply the on-board electrical system with power (→ page 347).

▶ Load the vehicle onto the transporter.

▶ **Vehicles with automatic transmission:** shift the automatic transmission to position **[P]**.

▶ Use the electric parking brake to secure the vehicle against rolling away.

▶ Only secure the vehicle by the wheels.

#### Vehicles with ADS PLUS (Adaptive Damping System PLUS)

**⚠ WARNING** Risk of an accident when transporting vehicles with Adaptive Damping System PLUS

When transporting vehicles with Adaptive Damping System PLUS, the vehicle/trailer combination may begin to rock and start to skid.

- ▶ Load the vehicle correctly onto the transporter.
- ▶ Secure the vehicle on all four wheels with suitable tensioning straps.
- ▶ Do not exceed the maximum permissible speed of 35 mph (60 km/h) when transporting.

**!** **NOTE** Damage to the vehicle from securing it incorrectly

- ▶ After loading, the vehicle must be secured on all four wheels. Otherwise, the vehicle could be damaged.
- ▶ A minimum distance of 8 in (20 cm) upwards and 4 in (10 cm) downwards must be kept to the transport platform.

▶ Secure the vehicle at all four wheels after loading.

#### 4MATIC vehicles/vehicles with automatic transmission

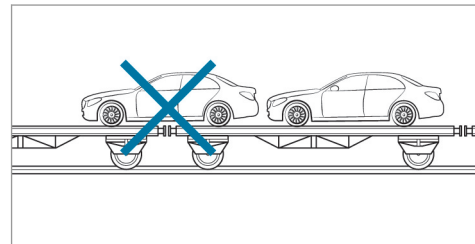

▶ Make sure that the front and rear axles come to rest on the same transportation vehicle.

**!** **NOTE** Damage to the drive train due to incorrect positioning of the vehicle

▶ Do not position the vehicle above the connection point of the transport vehicle.

### Towing eye storage location

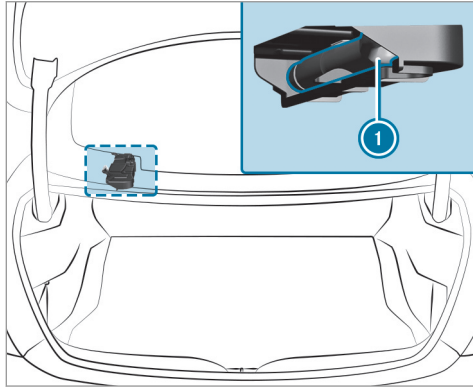

Towing eye ① is in a bracket under the rear shelf.

### Installing and removing the towing eye

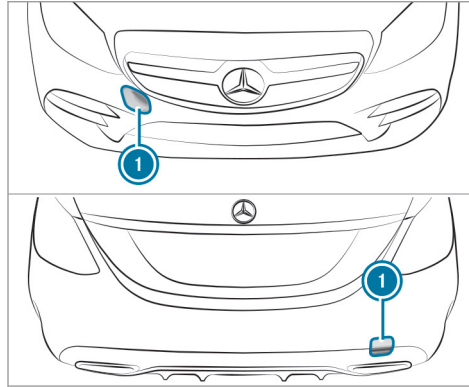

- ▶ Press the mark on cover ① inwards and remove.
- ▶ Screw in the towing eye clockwise as far as it will go and tighten.
- ▶ Make sure that cover ① engages in the bumper when you remove the towing eye.

**!** **NOTE** Damage to the vehicle due to incorrect use of the towing eye or trailer hitch

When a towing eye or trailer hitch is used to recover a vehicle, the vehicle may be damaged in the process.

- ▶ Only use the towing eye or trailer hitch to tow away or tow start the vehicle.
- ▶ Do not use the towing eye or trailer hitch to tow the vehicle during recovery.

### Tow-starting the vehicle

#### Vehicles with automatic transmission

**!** **NOTE** Damage to the automatic transmission due to tow starting

The automatic transmission may be damaged in the process of tow starting vehicles with automatic transmission.

- ▶ Vehicles with automatic transmission must not be tow started.

- ▶ Vehicles with automatic transmissions must not be tow-started.

## Electrical fuses

### Notes on electrical fuses

**⚠ WARNING** Risk of accident and injury due to overloaded lines

If you manipulate or bridge a faulty fuse or if you replace it with a fuse with a higher amperage, the electric line could be overloaded.

This could result in a fire.

- ▶ Always replace faulty fuses with specified new fuses containing the correct amperage.

**! NOTE** Damage due to incorrect fuses

Using incorrect fuses can result in damage to electrical components or systems or their functions being considerably restricted.

- ▶ Use only fuses approved for Mercedes-Benz with the respective specified fuse rating.

Blown fuses must be replaced with fuses of the same rating, which you can recognize by the color and the label. The fuse ratings and further information to be observed can be found in the fuse assignment diagram.

**Fuse assignment diagram:** on the fuse box in the trunk (→ page 356).

**! NOTE** Damage or malfunctions caused by moisture

Moisture may cause damage to the electrical system or cause it to malfunction.

- ▶ When the fuse box is open, make sure that no moisture can enter the fuse box.
- ▶ When closing the fuse box, make sure that the seal of the lid is positioned correctly on the fuse box.

If the newly inserted fuse also blows, have the cause traced and rectified at a qualified specialist workshop.

Ensure the following before replacing a fuse:

- The vehicle is secured against rolling away.
- All electrical consumers are switched off.
- The vehicle is switched off.

The electrical fuses are located in various fuse boxes:

- Fuse box in the engine compartment on the driver's side (→ page 355)
- Fuse box on the driver's side of the cockpit (→ page 356)
- Fuse box in the front passenger footwell (→ page 356)
- Fuse box in the trunk on the right-hand side of the vehicle, when viewed in the direction of travel (→ page 356)

## Opening and closing the fuse box in the engine compartment

### Requirements

- A dry cloth and a screwdriver are to hand.

Observe the notes on electrical fuses (→ page 354).

### Opening

**⚠ WARNING** Risk of injury from using the windshield wipers when the hood is open

If the windshield wipers start moving when the hood is open, you could be trapped by the wiper linkage.

- ▶ Always switch off the windshield wipers and the vehicle first if you need to open the hood.

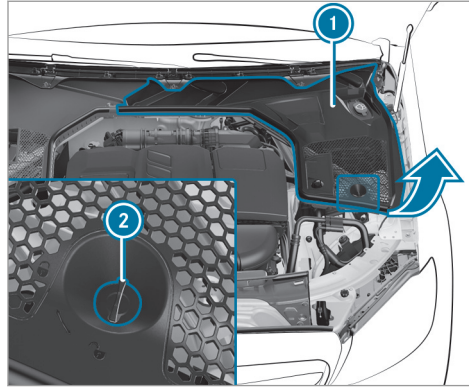

- ▶ Turn retaining clip ② on cover ① a quarter-turn counter-clockwise.
- ▶ Fold cover ① up in the direction of the arrow.

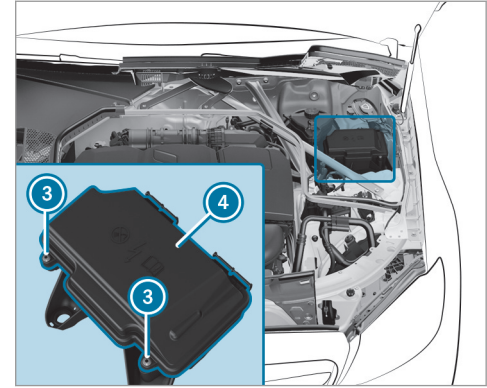

- ▶ Remove any moisture present from the fuse box using a dry cloth.
- ▶ Unscrew screws ③ and remove fuse box lid ④ from the top.

### Closing

- ▶ Check whether the seal is positioned correctly in lid ④.

- ▶ Insert lid ④ into the bracket at the rear of the fuse box.
- ▶ Fold down lid ④ of the fuse box and tighten screws ③.
- ▶ Fold down cover ①.
- ▶ Turn retaining clip ② on cover ① a quarter-turn clockwise.
- ▶ Close the hood.

### Opening and closing the fuse box in the cockpit

- Observe the notes on electrical fuses (→ page 354).

The fuse box is on the driver's side on the side of the cockpit under a cover.

- ▶ To open and close it, consult an authorized Mercedes-Benz Center.

### Opening and closing the fuse box in the front passenger footwell

Observe the notes on electrical fuses (→ page 354).

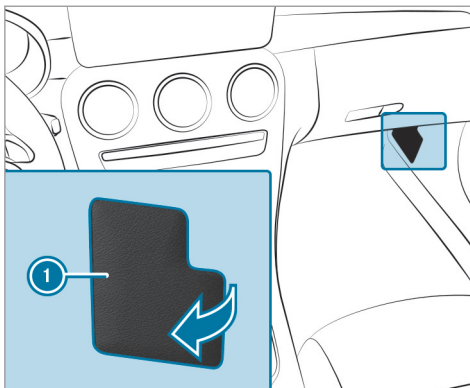

- ▶ **To open:** open cover ① in the direction of the arrow and remove it.
- ▶ **To close:** reinsert cover ①.

### Opening and closing the fuse box in the trunk

Observe the notes on electrical fuses (→ page 354).

- ▶ Open the trunk floor .

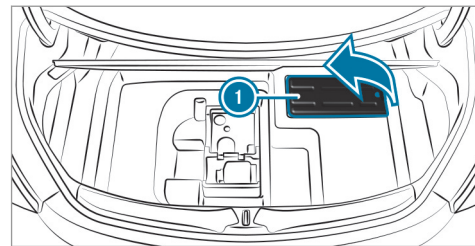

- ▶ Fold cover ① up in the direction of the arrow.

The fuse assignment diagram is in a recess on the side of the fuse box.

### Notes on noise or unusual handling characteristics

Make sure there are no vibrations, noises or unusual handling characteristics when the vehicle is in motion. This may indicate that the wheels or tires are damaged. Hidden tire damage could also be causing the unusual handling characteristics.

If you suspect that a tire is defective, reduce your speed immediately and have the tires and wheels checked at a qualified specialist workshop.

### Notes on regularly inspecting wheels and tires

**⚠ WARNING** Risk of injury through damaged tires

Damaged tires can cause tire pressure loss.

- ▶ Check the tires regularly for signs of damage and replace any damaged tires immediately.

**⚠ WARNING** Risk of hydroplaning due to insufficient tire tread

Insufficient tire tread will result in reduced tire grip.

In heavy rain or slush the risk of hydroplaning is increased, in particular where speed is not adapted to suit the conditions.

- ▶ Thus, you should regularly check the tread depth and the condition of the tread across the entire width of all tires.

Minimum tread depth for:

- Summer tires:  $\frac{1}{8}$  in (3 mm)
- M+S tires:  $\frac{1}{16}$  in (4 mm)

- ▶ For safety reasons, replace the tires before the legally-prescribed limit for the minimum tread depth is reached.

Carry out the following checks on all wheels regularly, at least once a month or as required, for example, prior to a long journey or driving off-road:

- Check the tire pressure (→ page 358).

- Visually inspect wheels and tires for damage.
- Check the valve caps.
- Visual check of the tire tread depth and the tire contact surface across the entire width.

The minimum tread depth for summer tires is  $\frac{1}{8}$  in (3 mm) and for winter tires  $\frac{1}{16}$  in (4 mm).

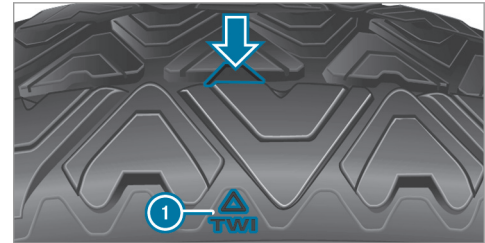

Six marks ① show where the bar indicators (arrow) are integrated into the tire tread. They are visible once a tire tread depth of approximately  $\frac{1}{16}$  in (1.6 mm) has been reached.

### Notes on snow chains

**⚠ WARNING** Risk of accident due to incorrectly installed snow chains

If you have installed snow chains on the front wheels, they may drag against the vehicle body or chassis components.

- ▶ Never install snow chains on the front wheels.
- ▶ Only install snow chains on the rear wheels in pairs.

**ℹ NOTE** Damage to components of the vehicle body or chassis due to mounted snow chains

If you mount snow chains to the front wheels of 4MATIC vehicles, you may damage components of the vehicle body or chassis.

- ▶ Only mount snow chains to the rear wheels of 4MATIC vehicles.

Observe the following notes when using snow chains:

- Snow chains are only permissible for certain wheel/tire combinations. You can obtain information about this from a authorized Mercedes-Benz Service Center.
  - For safety reasons, only use snow chains that have been specifically approved for your vehicle by Mercedes-Benz, or snow chains with the same quality standard.
  - Comply with the installation instructions of the snow chain manufacturer.
  - If snow chains are installed, the maximum permissible speed is 30 mph (50 km/h).
  - **Vehicles with Active Parking Assist:** do not use Active Parking Assist when snow chains are installed.
  - **Vehicles with level control:** if snow chains are installed, only drive at raised vehicle level (→ page 188).
- i** You can deactivate ESP® to pull away (→ page 159). This allows the wheels to spin, achieving an increased driving force.

### Tire pressure

#### Notes on tire pressure

**⚠ WARNING** Risk of accident due to insufficient or excessive tire pressure

Underinflated or overinflated tires pose in particular the following risks:

- The tires can burst.
  - The tires can wear excessively and/or unevenly.
  - The driving characteristics as well as the steering and braking characteristics may be greatly impaired.
- ▶ Comply with the recommended tire pressures and check the tire pressure of all tires, including the spare wheel, regularly:
- Monthly
  - When the load changes
  - Before embarking on a longer journey



- If operating conditions change, e.g. off-road driving
- ▶ Adjust the tire pressure, if necessary.

Tire pressure which is too high or too low can:

- Shorten the service life of the tires.
- Cause increased tire damage.
- Adversely affect driving characteristics and thus driving safety, e.g. due to hydroplaning.

**⚠ WARNING** Risk of accident due to too low a tire pressure

Tires with pressure that is too low can over-heat and burst as a consequence.

In addition, they also suffer from irregular wear, which can significantly impair the braking properties and the handling characteristics.

- ▶ Avoid excessively low tire pressure.

Tire pressure which is too low can cause:

- Tire defects as a result of overheating

- Impaired handling characteristics
- Irregular wear
- Increased fuel consumption

**⚠ WARNING** Risk of accident due to too high a tire pressure

Tires with excessively high pressure can burst. In addition, they also suffer from irregular wear, which can significantly impair the braking properties and the handling characteristics.

- ▶ Avoid excessively high tire pressures.

Tire pressure which is too high can cause:

- Increased braking distance
- Impaired handling characteristics
- Irregular wear
- Impaired driving comfort
- Susceptibility to damage

**⚠ WARNING** Risk of accident due to repeated pressure drop in the tires

The wheels, valves or tires could be damaged. Too low a tire pressure can lead to the tires bursting.

- ▶ Examine the tires for foreign objects.
- ▶ Check whether the tire has a puncture or the valve has a leak.
- ▶ If you are unable to rectify the damage, contact a qualified specialist workshop.

You can find information on tire pressure for the vehicle's factory-installed tires on the following labels:

- Tire and loading information placard on the B-pillar of your vehicle (→ page 365).
- Tire pressure table on the inside of the fuel filler flap (→ page 360).

Observe the maximum tire pressure (→ page 371).

Use a suitable pressure gauge to check the tire pressure. The outer appearance of a tire does not

permit any reliable conclusion about the tire pressure.

Only correct the tire pressure when the tires are cold. Conditions for cold tires:

- The vehicle has been parked with the tires out of direct sunlight for at least three hours.
- The vehicle has traveled less than 1 mile (1.6 km).

The vehicle's tires heat up when driving. As the temperature of the tires increases, so too does the tire pressure.

**Vehicles with a tire pressure monitoring system:** you can also check the tire pressure using the on-board computer (→ page 362).

The tire pressure recommended for increased load/speed in the tire pressure table can affect the ride comfort.

**⚠ WARNING** Risk of accident due to unsuitable accessories on tire valves

If you mount unsuitable accessories onto tire valves, the tire valves may be overloaded and

malfunction, which can cause tire pressure loss.

- ▶ Only screw standard valve caps or valve caps specifically approved by Mercedes-Benz for your vehicle onto the tire valve.

### Tire pressure table

The tire pressure table is on the inside of the fuel filler flap.

- ⓘ The data shown in the images is example data.

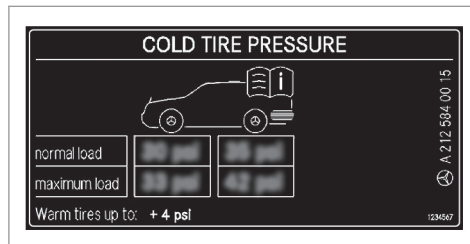

The tire pressure table shows the recommended tire pressure for all tires approved for this vehicle. The recommended tire pressures are valid for cold tires under various operating conditions according to the load and/or speed of the vehicle.

If one or more tire sizes precede a tire pressure, the following tire pressure information is only valid for those tire sizes and their respective load condition.

The load conditions "partially laden" and "fully laden" are defined in the table for different numbers of passengers and amounts of luggage. The actual number of seats may differ from this.

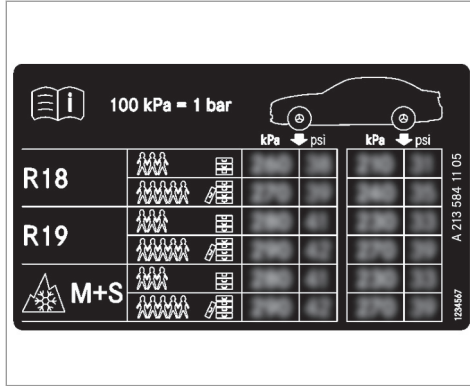

Some tire pressure tables only show the rim diameter instead of the complete tire size, e.g. **R18**. The rim diameter is part of the tire size and can be found on the tire side wall (→ page 372).

- Tire and loading information placard (→ page 365)
- Maximum tire pressure (→ page 371)

### Checking the tire pressure manually

- ▶ Read the tire pressure recommended for the current operating conditions from the tire and loading information placard or the tire pressure table. Observe the notes on tire pressure.
- ▶ Remove the valve cap of the tire to be checked.
- ▶ Press the tire pressure gauge securely onto the valve.
- ▶ Read the tire pressure.
- ▶ If the tire pressure is lower than the recommended value, increase the tire pressure to the recommended value.
- ▶ If the tire pressure is higher than the recommended value, release air. To do so, press down the metal pin in the valve, e.g. using the tip of a pen. Then check the tire pressure again using the tire pressure gauge.
- ▶ Screw the valve cap onto the valve.

Further related subjects:

- Notes on tire pressure (→ page 358)
- Tire pressure table (→ page 360)

- Tire and loading information placard (→ page 365)

### Tire pressure monitoring system

#### Function of the tire pressure monitoring system

**⚠ DANGER** Risk of accident due to incorrect tire pressure

Each tire, including the spare (if provided), should be checked monthly when cold and inflated to the inflation pressure recommended by the vehicle manufacturer on the vehicle placard or tire inflation pressure label. (If your vehicle has tires of a different size than the size indicated on the vehicle placard or tire inflation pressure label, you should determine the proper tire inflation pressure for those tires.)

As an added safety feature, your vehicle has been equipped with a tire pressure monitoring system (TPMS) that illuminates a low tire pressure telltale when one or more of your tires is significantly under-inflated. Accordingly, when

the low tire pressure telltale illuminates, you should stop and check your tires as soon as possible, and inflate them to the proper pressure. Driving on a significantly under-inflated tire causes the tire to overheat and can lead to tire failure. Under-inflation also reduces fuel efficiency and tire tread life, and may affect the vehicle's handling and stopping ability. Please note that the TPMS is not a substitute for proper tire maintenance, and it is the driver's responsibility to maintain correct tire pressure, even if under-inflation has not reached the level to trigger illumination of the TPMS low tire pressure telltale.

Your vehicle has also been equipped with a TPMS malfunction indicator to indicate when the system is not operating properly. The TPMS malfunction indicator is combined with the low tire pressure telltale. When the system detects a malfunction, the telltale will flash for approximately one minute and then remain continuously illuminated. This sequence will continue upon subsequent vehicle start-ups as long as the malfunction exists.

When the malfunction indicator is illuminated, the system may not be able to detect or signal low tire pressure as intended. TPMS malfunctions may occur for a variety of reasons, including the installation of replacement or alternate tires or wheels on the vehicle that prevent the TPMS from functioning properly.

The system checks the tire pressure and the tire temperature of the tires fitted to the vehicle by means of a tire pressure sensor.

The tire pressure and the tire temperature appear on the on-board computer (→ page 362).

If there is a substantial pressure loss or if the tire temperature is excessive, you will be warned with display messages (→ page 443) or the  warning lamp in the instrument cluster (→ page 464).

The tire pressure monitoring system is only an aid. It is the driver's responsibility to set the tire pressure to the recommended cold tire pressure suitable for the operating situation.

In most cases, the tire pressure monitoring system will automatically update the new reference

values after you have changed the tire pressure. You can, however, also update the reference values by restarting the tire pressure monitoring system manually (→ page 363).

### System limits

The system may be impaired or may not function particularly in the following situations:

- incorrect reference values were taught in
- sudden pressure loss caused by a foreign object penetrating the tire, for example
- there is a malfunction caused by another radio signal source

### Checking the tire pressure with the tire pressure monitoring system

#### Requirements

- The vehicle is switched on.

On-board computer:

 [Service](#)  [Tires](#)

One of the following displays appears:

- Current tire pressure and tire temperature of the individual wheels:

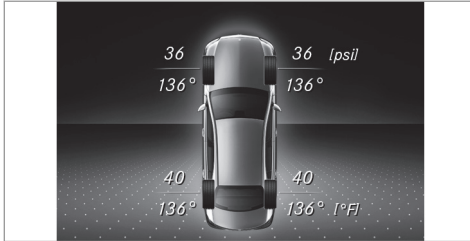

- **Tire pressure will be displayed after driving a few minutes**
  - **Tire Pressure Monitor Active:** the teach-in process of the system is not yet complete. The tire pressures are already being monitored.
- ▶ Compare the tire pressure with the recommended tire pressure for the current operating condition (→ page 360). Additionally, observe the notes on cold tires (→ page 358).
- ⓘ The values displayed in the on-board computer may deviate from those of the tire pressure gage as they refer to sea level. At high elevations, the tire pressure value indicated by a pressure gage is higher than that shown

by the on-board computer. Do not reduce the tire pressure in this case.

### Restarting the tire pressure monitoring system

#### Requirements

- The recommended tire pressure is correctly set for the respective operating condition in all of the wheels (→ page 358).

Restart the tire pressure monitoring system in the following situations:

- The tire pressure has been changed.
- The wheels or tires have been changed or newly installed.

On-board computer:

↪ **Service** ▶ **Tires**

- ▶ Swipe downwards on the Touch Control on the left-hand side of the steering wheel. The **Use Current Pressures as New Reference Values?** message will be shown on the instrument display.

- ▶ To restart, press the Touch Control on the left-hand side of the steering wheel.

The **Tire Press. Monitor Restarted** message will be shown on the instrument display.

Current warning messages will be deleted and the yellow  warning lamp will go out.

After you have been driving for a few minutes, the system will check whether the current tire pressures are within the specified range. The current tire pressures will then be accepted as reference values and monitored.

Be sure to also pay attention to the following related topic:

- Notes on tire pressure (→ page 358)

### Tire pressure loss warning system

#### Function of the tire pressure loss warning system

The tire pressure loss warning system warns the driver by means of display messages when there is a severe tire pressure loss.

### System limits

The system may be impaired or may not function particularly in the following situations:

- incorrect reference values were taught in
- sudden pressure loss caused by a foreign object penetrating the tire, for example
- an even pressure loss on more than one tire occurs

The system has a restricted or delayed function particularly in the following situations:

- poor ground conditions, e.g. snow or gravel
- driving with snow chains
- when adopting a very sporty driving style with high cornering speeds or sudden acceleration
- driving with a high load

The tire pressure loss warning system is only an aid. It is the driver's responsibility to set the tire pressure to the recommended cold tire pressure suitable for the operating situation and to check it.

Be sure to also observe the following further related subjects:

- Notes on tire pressure (→ page 358)
- Display messages about the tires (→ page 443)

### Restarting the tire pressure loss warning system

#### Requirements

- The recommended tire pressure is correctly set for the respective operating condition in all wheels.

Restart the tire pressure loss warning system in the following situations:

- The tire pressure has changed.
- The wheels or tires have been changed or newly installed.

On-board computer:

➤ [Service](#) ➤ [Tires](#)

- ▶ Swipe downwards on the Touch Control on the left-hand side of the steering wheel. The **Tire Pressure Control System Active Restart: Press Touch Control** message will be shown on the display.
- ▶ To begin the restart, press the Touch Control on the left-hand side of the steering wheel. The **Tire Pressure Now OK?** message will be shown on the display.
- ▶ Select **Yes**.
- ▶ To confirm the restart, press the Touch Control on the left-hand side of the steering wheel. The **Run Flat Indicator Restarted** message will be shown on the display. After you have been driving for a few minutes, the tire pressure loss warning system monitors the set tire pressure of all the tires.

Be sure to also pay attention to the following related topic:

- Notes on tire pressure (→ page 358)

## Loading the vehicle

### Notes on Tire and Loading Information placard

**⚠ WARNING** Risk of accident from overloaded tires

Overloaded tires may overheat and burst as a consequence. Overloaded tires can also impair the steering and handling characteristics and lead to brake failure.

- ▶ Observe the load rating of the tires.
- ▶ The load rating must be at least half the permissible axle load of the vehicle.
- ▶ Never overload the tires by exceeding the maximum load.

The Tire and Loading Information placard is on the B-pillar on the driver's side of the vehicle.

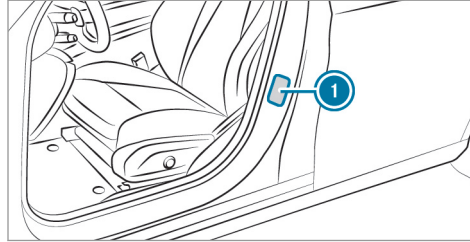

① Tire and Loading Information placard

TIRE AN RENSEIGNEMENTS		LOADING INFORMATION		LE CHARGEMENT	
SEATING CAPACITY NOMBRE DE PLACES	TOTAL	FRONT AVANT	MIDDLE MI	REAR ARRIÈRE	
	7	2	3	2	
The combined weight of occupants and cargo should never exceed Le poids total des occupants et du chargement ne doit jamais dépasser		xxx kg or xxx lbs.*			
TIRE PNEU	SIZE DIMENSIONS	COLD TIRE PRESSURE PRESSION DES PNEUS À FROID		SEE OWNER'S MANUAL FOR ADDITIONAL INFORMATION	
FRONT AVANT	285/40 ZR18 99Y XL	200 KPA, 29 PSI		VOIR LE MANUEL DE L'USAGER POUR PLUS DE RENSEIGNEMENTS	
REAR ARRIÈRE	285/35 ZR18 101Y XL	200 KPA, 29 PSI			
SPARE DE SECOURS	175/55-18 95P	420 KPA, 60 PSI			

① The data shown in the illustration is example data.

The Tire and Loading Information placard shows the following information:

- Maximum number of seats ② according to the maximum number of people permitted to travel in the vehicle.

- Maximum permissible load **③** comprises the gross weight of all vehicle occupants, load and luggage.
- Recommended tire pressure **①** for cold tires. The recommended tire pressures are valid for the maximum permissible load and up to the maximum permissible vehicle speed.

Please also note:

- Information on permissible weights and loads on the vehicle identification plate (→ page 390).
- Information on tire pressure in the tire pressure table (→ page 360).

Further related subjects:

- Determining the maximum permissible load (→ page 366)
- Notes on tire pressure (→ page 358).

### Steps for Determining Correct Load Limit

The following steps have been developed as required of all manufacturers under Title 49, Code of U.S. Federal Regulations, Part 575, pursuant to

the "National Traffic and Motor Vehicle Safety Act of 1966".

- ▶ **(1):** Locate the statement "The combined weight of occupants and cargo should never exceed XXX kg or XXX lbs." on your vehicle's placard.
- ▶ **(2):** Determine the combined weight of the driver and passengers that will be riding in your vehicle.
- ▶ **(3):** Subtract the combined weight of the driver and passengers from XXX kg or XXX lbs.
- ▶ **(4):** The resulting figure equals the available amount of cargo and luggage load capacity. For example, if the "XXX" amount equals 1,400 lbs. and there will be five 150 lb passengers in your vehicle, the amount of available cargo and luggage load capacity is 650 lbs.  $(1,400 - 750 (5 \times 150) = 650 \text{ lbs.})$
- ▶ **(5):** Determine the combined weight of luggage and cargo being loaded on the vehicle. That weight may not safely exceed the available cargo and luggage load capacity calculated in Step 4.

- ▶ **(6):** If your vehicle will be towing a trailer, load from your trailer will be transferred to your vehicle. Consult this manual to determine how this reduces the available cargo and luggage load capacity of your vehicle.

- ⓘ Not all vehicles are permitted to tow a trailer. Towing a trailer is only permitted if a trailer-hitch is installed. Please consult an authorized Mercedes-Benz dealer if you have any questions about towing a trailer with your vehicle.

Even if you have calculated the total load carefully, you should still make sure that the maximum permissible gross weight and the maximum gross axle weight rating of your vehicle are not exceeded. Details can be found on the vehicle identification plate.

- ▶ Have your loaded vehicle – including driver, occupants and load – weighed on a vehicle weighbridge. The measured values may not exceed the maximum permissible values stated on the vehicle identification plate.



Further related subjects:

- Calculation example for determining the maximum load (→ page 367)
- Tire and Loading Information placard (→ page 365)
- Tire pressure table (→ page 360)
- Vehicle identification plate (→ page 390)

### Calculation example for determining the maximum load

The following table shows examples of how to calculate total and load capacities with varying seating configurations and different numbers and sizes of occupants. The following examples use a maximum load of 1500 lbs (680 kg). **This is for**

**illustration purposes only.** Make sure you are using the actual load limit for your vehicle stated on your vehicle's Tire and Loading Information placard (→ page 365).

The higher the weight of all the occupants, the smaller the maximum load for luggage.

#### Step 1

	Example 1	Example 2
Combined maximum weight of occupants and load (data from the Tire and Loading Information placard)	1500 lbs (680 kg)	1500 lbs (680 kg)

**Step 2**

	Example 1	Example 2
Number of people in the vehicle (driver and occupants)	5	1
Distribution of the occupants	Front: 2 Rear: 3	Front: 1
Weight of occupants	Occupant 1: 150 lbs (68 kg) Occupant 2: 180 lbs (82 kg) Occupant 3: 160 lbs (73 kg) Occupant 4: 140 lbs (63 kg) Occupant 5: 120 lbs (54 kg)	Occupant 1: 200 lbs (91 kg)
Total weight of all occupants	750 lbs (340 kg)	200 lbs (91 kg)

**Step 3**

	Example 1	Example 2
Permissible load (maximum gross vehicle weight rating from the Tire and Loading Information placard minus the gross weight of all occupants)	1500 lbs (680 kg) - 750 lbs (340 kg) = 750 lbs (340 kg)	1500 lbs (680 kg) - 200 lbs (91 kg) = 1300 lbs (589 kg)

## Tire labeling

### Overview of tire labeling

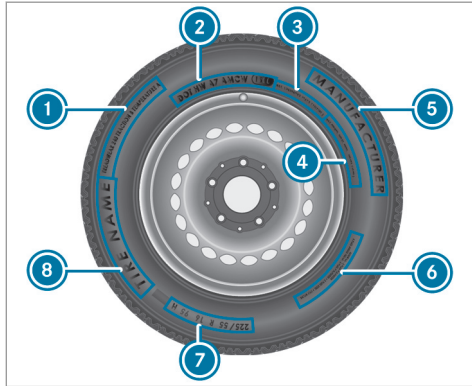

- ① Uniform Tire Quality Grading Standards
- ② DOT (Department of Transportation), (TIN) Tire Identification Number
- ③ Maximum tire load (→ page 371)
- ④ Maximum tire pressure (→ page 371)

- ⑤ Manufacturer
  - ⑥ Characteristics of the tire (→ page 372)
  - ⑦ Tire size designation, load-bearing capacity, speed rating and load index (→ page 372)
  - ⑧ Tire name
- ① The data shown in the illustration is example data.

### Tire Quality Grading

In accordance with the US Department of Transportation's "Uniform Tire Quality Grading Standards", tire manufacturers are required to grade their tires on the basis of the following three performance factors:

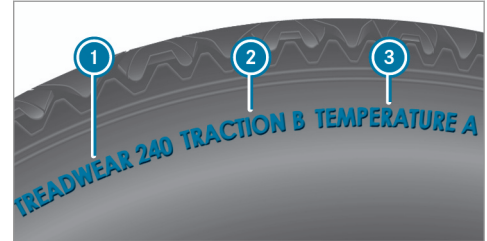

- ① Tread wear grade
  - ② Traction grade
  - ③ Temperature grade
- ① The data shown in the illustration is example data.
- ① The classification is not legally stipulated for Canada, but it is generally stated.

### Tread wear grade

The treadwear grade is a comparative rating based on the wear rate of the tire when tested under controlled conditions on a specified government test course. For example, a tire graded 150 would wear one and one-half (1½) times as

## 370 Wheels and tires

well on the government course as a tire graded 100.

The relative performance of tires depends upon the actual conditions of their use, however, and may depart significantly from the norm due to variations in driving habits, service practices and differences in road characteristics and climate.

### Traction grade

**⚠ DANGER** Risk of accident due to inadequate traction

The traction grade assigned to this tire is based on straight-ahead braking traction tests.

- ▶ Always adapt your driving style and drive at a speed to suit the prevailing traffic and weather conditions.

**❗ NOTE** Damage to the drivetrain from wheelspin

- ▶ Avoid wheelspin.

The traction grades, from highest to lowest, are AA, A, B, and C. Those grades represent the tire's ability to stop on wet pavement as measured under controlled conditions on specified government test surfaces of asphalt and concrete. A tire marked C may have poor traction performance.

### Temperature grade

**⚠ WARNING** Risk of accident from tire overheating and tire failure

Excessive speed, underinflation, or excessive loading, either separately or in combination, can cause excessive heat build-up and possible tire failure.

- ▶ Observe the recommended tire pressure.
- ▶ Regularly check the pressure of all the tires.
- ▶ Adjust the tire pressure, if necessary.

The temperature grades are A (the highest), B, and C, representing the tire's resistance to the generation of heat and its ability to dissipate heat when tested under controlled conditions on a specified indoor laboratory test wheel. Sustained

high temperature can cause the material of the tire to degenerate and reduce tire life, and excessive temperature can lead to sudden tire failure. The grade C corresponds to a level of performance which all passenger car tires must meet under the Federal Motor Safety Standard No. 109. Grades B and A represent higher levels of performance on the laboratory test wheel than the minimum required by law.

### DOT, Tire Identification Number (TIN)

US tire regulations stipulate that every tire manufacturer or retreader must imprint a TIN in or on the side wall of each tire produced.

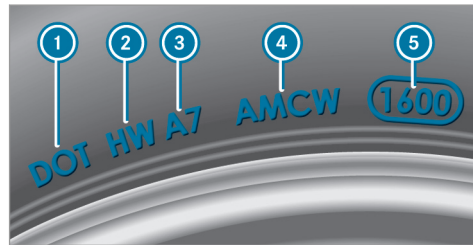

**i** The data shown in the image is example data. The TIN is a unique identification number to identify tires and comprises the following:

- **DOT (Department of Transportation):** tire symbol marks **1** indicating that the tire complies with the requirements of the US Department of Transportation.
- **Manufacturer identification code:** manufacturer identification code **2** contains details of the tire manufacturer. New tires have a code with two symbols. Retreaded tires have a code with four symbols. Further information on retreaded tires (→ page 376).
- **Tire size:** identifier **3** describes the tire size.
- **Tire type code:** tire type code **4** can be used by the manufacturer as a code to describe specific characteristics of the tire.
- **Manufacturing date:** manufacturing date **5** provides information about the age of a tire. The 1st and 2nd positions represent the calendar week and the 3rd and 4th positions state the year of manufacture (e.g. "3208" represents the 32nd week of 2008).

### Information on the maximum tire load



**i** The data shown in the illustration is example data.

Maximum tire load **1** is the maximum permissible weight for which the tire is approved.

Do not overload the tires by exceeding the specified load limit. The maximum permissible load can be found on the vehicle's tire and loading information placard on the B-pillar on the driver's side (→ page 365).

### Specifications for maximum tire pressure

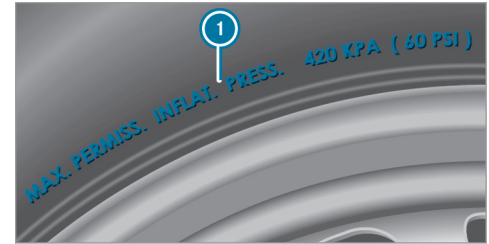

**i** The data shown in the illustration is example data.

Never exceed maximum tire pressure **1** specified for the tire. Always observe the recommended tire pressure for your vehicle when adjusting the tire pressure (→ page 360).

### Information on tire characteristics



**i** The data shown in the image is example data. This information describes the type of tire cord and the number of layers in side wall **1** and under tire tread **2**.

### Tire size designation, load-bearing capacity, speed rating and load index

**⚠ WARNING** Risk of injury through exceeding the specified tire load-bearing capacity or the permissible speed rating

Exceeding the specified tire load rating or the permissible speed rating may lead to tire damage and to the tires bursting.

- ▶ Therefore, only use tire types and sizes approved for your vehicle model.
- ▶ Observe the tire load rating and speed rating required for your vehicle.



- 1** First letter(s)
- 2** Nominal tire width in millimeters
- 3** Aspect ratio in %
- 4** Tire code
- 5** Rim diameter
- 6** Load-bearing index
- 7** Speed rating
- 8** Load index

**i** The data shown in the illustration is example data.

Information about reading tire data can be obtained from any qualified specialist workshop.

**First letter(s) 1:**

- Without: passenger vehicle tires according to European manufacturing standards.
- "P": passenger vehicle tires according to US manufacturing standards.
- "LT": light truck tires according to US manufacturing standards.
- "T": compact emergency spare wheels with high tire pressure that are only designed for temporary use in an emergency.

**Aspect ratio 3:**

Ratio between tire height and tire width in percent (tire height divided by tire width).

**Tire code 4 (tire type):**

- "R": radial tire
- "D": bias ply tire
- "B": bias radial tires
- "ZR": radial tire with a maximum speed above 149 mph (240 km/h) (optional)

**Rim diameter 5:**

The diameter of the bead seat (not the diameter of the rim flange). The rim diameter is specified in inches (in).

**Load-bearing index 6:**

Numerical code that specifies the maximum load-bearing capacity of a tire (e.g. "91" corresponds to 1,356 lbs (615 kg)).

The load-bearing capacity of the tire must be at least half the gross axle weight rating of your vehicle. Do not overload the tires by exceeding the specified load limit.

See also:

- Maximum permissible load on the tire and loading information placard (→ page 365)
- Maximum tire load (→ page 371)
- Load index

**Speed rating 7:**

Specifies the approved maximum speed of the tire.

- ⓘ An electronic speed limiter prevents your vehicle from exceeding a speed of 130 mph (210 km/h).

Make sure that your tires have the required speed rating. You can obtain information on the required speed rating from an authorized Mercedes-Benz Service Center.

**Summer tires**

Index	Speed rating
Q	up to 100 mph (160 km/h)
R	up to 106 mph (170 km/h)
S	up to 112 mph (180 km/h)
T	up to 118 mph (190 km/h)
H	up to 130 mph (210 km/h)
V	up to 149 mph (240 km/h)
W	up to 168 mph (270 km/h)
Y	up to 186 mph (300 km/h)

Index	Speed rating
ZR...Y <sup>1</sup>	up to 186 mph (300 km/h)
ZR...(..Y) <sup>1</sup>	over 186 mph (300 km/h)
ZR <sup>1</sup>	over 149 mph (240 km/h)

- Specifying the speed rating as the "ZR" index in tire code ④ is optional for tires up to 186 mph (300 km/h).
- If your tire code ④ includes "ZR" and there is no speed rating ⑦, find out what the maximum speed is from the tire manufacturer.
- If load-bearing index ⑥ and speed rating ⑦ are in brackets, the maximum speed rating of your tire is above 186 mph (300 km/h). To find out the maximum speed, ask the tire manufacturer.

<sup>1</sup> "ZR" stated in the tire code.

<sup>2</sup> Or "M+S"  for winter tires.

#### All-weather tires and winter tires

Index	Speed rating
Q M+S <sup>2</sup>	up to 100 mph (160 km/h)
T M+S <sup>2</sup>	up to 118 mph (190 km/h)
H M+S <sup>2</sup>	up to 130 mph (210 km/h)
V M+S <sup>2</sup>	up to 149 mph (240 km/h)

Winter tires bear the  snowflake symbol and fulfill the requirements of the Rubber Manufacturers Association (RMA) and the Rubber Association of Canada (RAC) regarding the tire traction on snow.

#### Load index ⑧:

- No specification given: standard load (SL) tire
- "XL" or "Extra Load": extra load tire or reinforced tire
- "Light Load": light load tire

- "C", "D", "E": a load range that depends on the maximum load that the tire can carry at a certain pressure

#### Definition of terms for tires and loading

**Tire structure and characteristics:** describes the number of layers or the number of rubber-coated belts in the tire contact surface and the tire wall. These are made of steel, nylon, polyester and other materials.

**Bar:** metric unit for tire pressure. 14.5038 pounds per square inch (psi) and 100 kilopascal (kPa) is the equivalent of one bar.

**DOT (Department of Transportation):** DOT-marked tires fulfill the requirements of the U.S. Department of Transportation.

**Average weight of the vehicle occupants:** the number of vehicle occupants for which the vehicle is designed, multiplied by 150 lb (68 kg).

**Uniform Tire Quality Grading Standards:** a uniform standard to grade the quality of tires with regard



to tread quality, tire traction and temperature characteristics. The quality grading assessment is made by the manufacturer following specifications from the U.S. government. The quality grade of a tire is printed on the side wall of the tire.

**Recommended tire pressure:** the recommended tire pressure is the tire pressure specified for the tires mounted on the vehicle at the factory.

The tire and information placard contains the recommended tire pressure for cold tires, the maximum permissible load and the maximum permissible vehicle speed.

The tire pressure table contains the recommended tire pressure for cold tires under various operating conditions, i.e. loading and/or speed of the vehicle.

**Increased vehicle weight due to optional equipment:** the combined weight of all standard and optional equipment available for the vehicle, regardless of whether it is actually installed on the vehicle or not.

**Rim:** the part of the wheel on which the tire is installed.

**GAWR (Gross Axle Weight Rating):** the GAWR is the maximum gross axle weight rating. The actual load on an axle must never exceed the gross axle weight rating. The gross axle weight rating can be found on the vehicle identification plate on the B-pillar on the driver's side.

**Speed rating:** the speed rating is part of the tire identification. It specifies the speed range for which a tire is approved.

**GVW (Gross Vehicle Weight):** the gross vehicle weight comprises the weight of the vehicle including fuel, tools, the spare wheel, any accessories installed, occupants, luggage and the trailer nose-weight, if applicable. The gross vehicle weight must not exceed the gross vehicle weight rating GVWR as specified on the vehicle identification plate on the B-pillar on the driver's side.

**GVWR (Gross Vehicle Weight Rating):** the GVWR is the maximum permitted gross weight of the fully laden vehicle (weight of the vehicle including all accessories, occupants, fuel, luggage and the trailer drawbar noseweight if applicable). The gross vehicle weight rating is specified on the vehicle identification plate on the B-pillar on the driver's side.

**Maximum weight of the laden vehicle:** the maximum weight is the sum of the curb weight of the vehicle, the weight of the accessories, the maximum load and the weight of optional equipment installed at the factory.

**Kilopascal (kPa):** metric unit for tire pressure. 6.9 kPa corresponds to 1 psi. Another unit for tire pressure is bar. 100 kilopascal (kPa) equals 1 bar.

**Load index:** in addition to the load-bearing index, the load index may also be printed on the side wall of the tire. This specifies the load-bearing capacity of the tire more precisely.

**Curb weight:** the weight of a vehicle with standard equipment including the maximum capacity of fuel, oil and coolant. It also includes the air conditioning system and optional equipment if these are installed on the vehicle, but does not include passengers or luggage.

**Maximum tire load:** the maximum tire load is the maximum permissible weight in kilograms or lbs for which a tire is approved.

**Maximum permissible tire pressure:** maximum permissible tire pressure for one tire.

**Maximum load on one tire:** maximum load on one tire. This is calculated by dividing the maximum axle load of one axle by two.

**PSI (pounds per square inch):** standard unit of measurement for tire pressure.

**Aspect ratio:** ratio between tire height and tire width in percent.

**Tire pressure:** the pressure inside the tire which applies an outward force to every square inch of the tire. The tire pressure is specified in pounds per square inch (psi), in kilopascals (kPa) or in bar. The tire pressure should only be corrected when the tires are cold.

**Cold tire pressure:** the tires are cold when the vehicle has been parked for at least 3 hours without direct sunlight on the tires or the vehicle has been driven for less than 1 mile (1.6 km).

**Tire contact surface:** the part of the tire that comes into contact with the road.

**Tire bead:** the purpose of the tire bead is to ensure that the tire sits securely on the wheel rim. There are several wire cores in the tire bead to prevent the tire from changing length on the wheel rim.

**Side wall:** the part of the tire between the tread and the tire bead.

**Weight of optional equipment:** the combined weight of the optional equipment weighing more than the replaced standard parts and more than 5 lbs (2.3 kg). This optional equipment, such as high-performance brakes, level control system, a roof luggage rack or high-performance batteries, is not included in the curb weight and the weight of the accessories.

**TIN (Tire Identification Number):** a unique identification number which can be used by a tire manufacturer to identify tires, for example, in a product recall, and thus identify the purchasers. The TIN is made up of the manufacturer's identity code, tire size, tire type code and the manufacturing date.

**Load-bearing index:** the load-bearing index is a code that contains the maximum load-bearing capacity of a tire.

**Traction:** traction is the grip resulting from friction between the tires and the road surface.

**Wear indicator:** narrow bars (tread wear bars) that are distributed over the tire contact surface. If the

tire tread is level with the bars, the wear limit of 1/16 in (1.6 mm) has been reached.

**Distribution of vehicle occupants:** distribution of vehicle occupants over designated seat positions in a vehicle.

**Maximum permissible payload weight:** nominal load and luggage load plus 150 lb (68 kg) multiplied by the number of seats in the vehicle.

### Changing a wheel

#### Notes on selecting, installing and replacing tires

**!** **NOTE** Mercedes-AMG vehicles

▶ Observe the notes in the Supplement. You could otherwise fail to recognize dangers.

**⚠** **WARNING** Risk of accident due to incorrect wheel and tire dimensions

If wheels and tires of the wrong size are installed, the service brakes or components in the

brake system and in the wheel suspension may be damaged.

- ▶ Always replace wheels and tires with ones that fulfill the specifications of the original part.

For wheels, pay attention to the following:

- Designation
- Type

For tires, pay attention to the following:

- Designation
- Manufacturer
- Type

**⚠ WARNING** Risk of injury through exceeding the specified tire load-bearing capacity or the permissible speed rating

Exceeding the specified tire load rating or the permissible speed rating may lead to tire damage and to the tires bursting.

- ▶ Therefore, only use tire types and sizes approved for your vehicle model.
- ▶ Observe the tire load rating and speed rating required for your vehicle.

**!** **NOTE** Vehicle and tire damage caused by non-approved tire types and sizes

For safety reasons, only use tires, wheels and accessories which have been specially approved by Mercedes-Benz for your vehicle.

These tires are specially adapted to the active safety systems, such as ABS, ESP® and 4MATIC, and marked as follows:

- MO = Mercedes-Benz Original
- MOE = Mercedes-Benz Original Extended (run-flat tires only for certain wheels)
- MO1 = Mercedes-Benz Original (only certain AMG tires)

Otherwise, certain properties, such as handling characteristics, vehicle noise emissions, consumption, etc. could be adversely affected. Furthermore, other tire sizes could result

in the tires rubbing against the body and axle components when loaded. This could result in damage to the tire or the vehicle.

Only use tires, wheels and accessories that have been checked and recommended by Mercedes-Benz.

**!** **NOTE** Risk to driving safety from retreaded tires

Retreaded tires are neither tested nor recommended by Mercedes-Benz, since previous damage cannot always be detected on retreaded tires.

For this reason driving safety cannot be guaranteed.

- ▶ Do not use used tires if you have no information about their previous usage.

**!** **NOTE** Possible wheel and tire damage when driving over obstacles

Large wheels have a smaller section width. As the section width decreases, the risk of

wheels and tires being damaged when driving over obstacles increases.

- ▶ Avoid obstacles or drive especially carefully.
- ▶ Reduce your speed when driving over curbs, speed bumps, manhole covers and potholes.
- ▶ Avoid particularly high curbs.

**!** **NOTE** Possible wheel and tire damage when parking on curbs or in potholes

Parking on curbs or in potholes can damage the wheels and tires.

- ▶ Only park on as level a surface as possible.
- ▶ Avoid curbs and potholes when parking.

**!** **NOTE** Damage to electronic component parts due to the use of tire-installing tools

**Vehicles with tire pressure monitoring system:** There are electronic component parts in the wheel.

If tire-installing tools are positioned in the area of the valve, the electronic components could be damaged.

- ▶ Tire-installing tools should not be applied in the area of the valve.
- ▶ Always have tires change at a qualified specialist workshop.

**!** **NOTE** Damage to summer tires at low ambient temperatures

At low ambient temperatures, tears could form when driving with summer tires, causing permanent damage to the tires.

- ▶ At temperatures below 45 °F (7 °C) use  M+S tires.

Accessory parts which are not approved for your vehicle by Mercedes-Benz, or which are not used correctly, can impair the operating safety.

Before purchasing and using non-approved accessories, visit a qualified specialist workshop and inquire about:

- Suitability

- Legal stipulations
- Factory recommendations

**!** **WARNING** Risk of accident with high performance tires

The special tire tread in combination with the optimized tire compound means that the risk of skidding and hydroplaning on wet roads is increased.

In addition, the tire grip is greatly reduced at a low outside temperature and tire running temperature.

- ▶ Switch on the ESP® and adapt your driving style accordingly.
- ▶ Use  M+S tires at outside temperatures of less than 50 °F (10 °C).
- ▶ Only use the tires for their intended purpose.

Observe the following when selecting, installing and replacing tires:

- Furthermore, the use of certain tire types in certain regions and areas of operation can be highly beneficial.
- Only use tires and wheels of the same type (summer tires, winter tires, MOExtended tires) and the same make.
- Only install wheels of the same size (left and right) on each axle.

It is only permissible to install a different wheel size in the event of a flat tire in order to drive to the specialist workshop.

- **Vehicles with a tire pressure monitoring system:** all installed wheels must be equipped with functioning sensors for the tire pressure monitoring system.
- At temperatures below 45°F (7°C) use winter tires or all-season tires marked  M+S for all wheels.

Winter tires provide the best possible grip in wintry road conditions.

- For M+S tires, only use tires with the same tread.
- Observe the maximum permissible speed for the M+S tire which is installed.  
If the tire's maximum speed is below that of the vehicle, this must be indicated by an appropriate label in the driver's field of vision.
- Break in new tires at moderate speeds for the first 60 miles (100 km).
- Replace the tires after six years at the latest, regardless of wear.
- **When replacing with tires that do not feature run-flat characteristics:** vehicles with MOExtended tires are not equipped with a TIREFIT kit at the factory. Equip the vehicle with a TIREFIT kit after replacing with tires that do not feature run-flat characteristics, e.g. winter tires.

For more information on wheels and tires, contact a qualified specialist workshop.

Be sure to also observe the following further related subjects:

- Notes on tire pressure (→ page 358)

- Tire and loading information placard (→ page 365)
- Tire size designation, load-bearing capacity, speed rating and load index (→ page 372)
- Tire pressure table (→ page 360)
- Notes on the emergency spare wheel (→ page 386)

#### Notes on rotating wheels

 **WARNING** Risk of injury through different wheel sizes

Rotating the front and rear wheels can severely impair the driving characteristics. The wheel brakes or suspension components may also be damaged.

 Rotate front and rear wheels only if the wheels and tires are of the same dimensions.

Observe the instructions and safety notes on "Changing a wheel" (→ page 376)

The wear patterns on the front and rear wheels differ:

- Front wheels wear more on the tire shoulder
- Rear wheels wear more in the center of the tire

Do not drive with tires that have too little tread depth. This significantly reduces traction on wet roads (hydroplaning).

On vehicles that have the same size front and rear wheels, rotate the wheels according to the intervals in the tire manufacturer's warranty book in your vehicle documents. If this is not available, rotate the tires every 3,000 to 6,000 miles (5,000 to 10,000 km), depending on the wear. Ensure that the direction of rotation is maintained.

### Notes on storing wheels

When storing wheels, observe the following notes:

- After removing wheels, store them in a cool, dry and preferably dark place.
- Protect the tires from contact with oil, grease or fuel.

### Overview of the tire-change tool kit

#### **!** NOTE Mercedes-AMG vehicles

▶ Observe the notes in the Supplement. You could otherwise fail to recognize dangers.

Apart from some country-specific variants, vehicles are not equipped with a tire-change tool kit. For more information on which tire-changing tools are required and approved for performing a wheel change on your vehicle, consult a qualified specialist workshop.

You require the following tools, foreexample, to change a wheel:

- Jack
- Chock
- Lug wrench
- Alignment bolt

The tire-change tool kit is located under the trunk floor.

**i** Depending on the model, the tire-change tool kit may be located at other positions under the trunk floor.

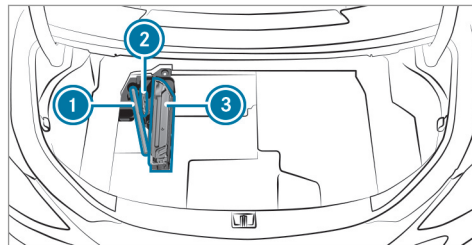

- 1** Lug wrench
- 2** Folding chock
- 3** Jack

### Preparing the vehicle for a wheel change

#### Requirements:

- The vehicle is not on a slope.
- The vehicle is on solid, non-slippery and level ground.

- The required tire-change tool kit is available.

**i** If your vehicle is not equipped with the tire-change tool kit, consult a qualified specialist workshop to find out about suitable tools.

- ▶ Apply the electric parking brake manually.
- ▶ Move the front wheels to the straight-ahead position.
- ▶ Shift the transmission to position **P**.
- ▶ **Vehicles with level control system:** Set the normal vehicle level (→ page 188).
- ▶ Switch off the vehicle.
- ▶ Make sure that the vehicle cannot be started.
- ▶ Place chocks or other suitable items under the front and rear of the wheel that is diagonally opposite the wheel you wish to change.
- ▶ If necessary, remove the wheel trim/hub caps (→ page 381).
- ▶ Raise the vehicle (→ page 382).

### Removing and installing the wheel trim/hub caps

#### Requirements

- The vehicle is prepared for a wheel change (→ page 380).

#### Plastic hub cap

- ▶ **To remove:** turn the center cover of the hub cap counter-clockwise and remove the hub cap.
- ▶ **To install:** make sure that the center cover of the hub cap is turned counter-clockwise.
- ▶ Position the hub cap and turn the center cover clockwise until the hub cap engages physically and audibly.

#### Aluminum hub cap

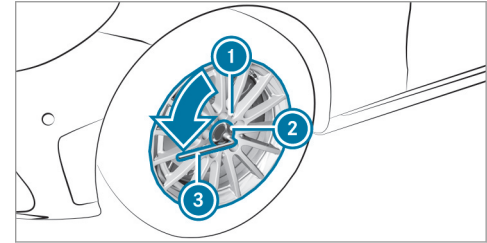

- ▶ **To remove:** position socket **2** from the tire-change tool kit on hub cap **1**.
  - ▶ Position wheel wrench **3** on socket **2**.
  - ▶ Using wheel wrench **3**, turn hub cap **1** counter-clockwise and remove it.
  - ▶ **To install:** follow the instructions above in reverse order.
- i** **Specified tightening torque:** 18 lb-ft (25 Nm).

### Raising the vehicle when changing a wheel

#### Requirements:

- There are no persons in the vehicle.
- The vehicle has been prepared for a wheel change (→ page 380).
- The wheel trims and hub caps have been removed (→ page 381).

#### Important notes on using the jack:

- Use only a vehicle-specific jack that has been approved by Mercedes-Benz to raise the vehicle.
- The jack is only designed for raising and holding the vehicle for a short time while a wheel is being changed and not for maintenance work under the vehicle.
- The jack must be placed on a firm, flat and non-slip surface. If necessary, use a large, flat, load-bearing, non-slip underlay.
- The foot of the jack must be positioned vertically under the jack support point.

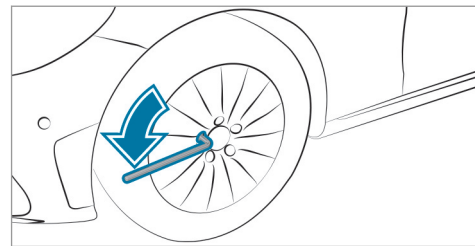
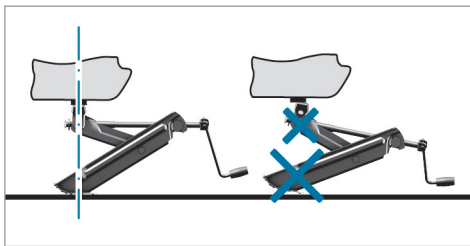

#### Rules of conduct when the vehicle is raised:

- Never place your hands or feet under the vehicle.
- Never lie under the vehicle.
- Do not start the vehicle and do not release the electric parking brake.
- Do not open or close any doors or the trunk lid.

- ▶ Using the lug wrench, loosen the wheel bolts on the wheel you wish to change by about one full turn. Do not unscrew the screws completely.



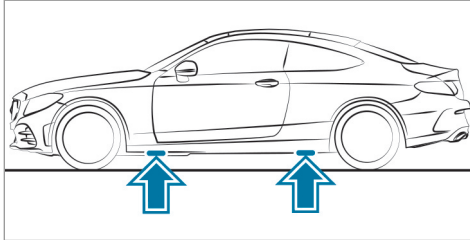

Position of the jack support points

**!** **NOTE** Mercedes-AMG vehicles

- ▶ Observe the notes in the Supplement. You could otherwise fail to recognize dangers.

**!** **WARNING** Risk of injury from incorrect positioning of the jack

If you do not position the jack correctly at the appropriate jacking point of the vehicle, the jack could tip with the vehicle raised.

- ▶ Only position the jack at the appropriate jacking point of the vehicle. The base of

the jack must be positioned vertically under the jacking point of the vehicle.

**!** **NOTE** Damage to the vehicle due to the jack

If you do not position the jack at the jack support points provided for this purpose, you could damage your vehicle.

- ▶ Only position the jack at the jack support points provided for this purpose.

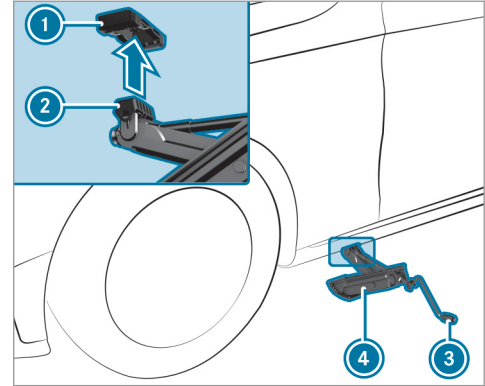

- ▶ Position support **2** of jack **4** on jack support point **1**.
- ▶ Turn crank **3** clockwise until support **2** sits completely on jack support point **1** and the base of the jack lies evenly on the ground.
- ▶ Turn crank **3** until the tire is raised a maximum of 1.2 in (3 cm) from the ground.
- ▶ Loosen and remove the wheel (→ page 384).

## Removing a wheel

### Requirements

- The vehicle is raised (→ page 382).

**!** **NOTE** Mercedes-AMG vehicles

- Observe the notes in the Supplement. You could otherwise fail to recognize dangers.

When changing a wheel, avoid applying any force to the brake discs, as this could impair the level of comfort when braking.

**!** **NOTE** Damage to the wheels' plastic elements when changing a wheel

Plastic elements on wheels may be damaged when removing and repositioning the wheel.

- Do not raise the wheels by the plastic elements when removing and repositioning.

**!** **NOTE** Damage to threading from dirt on wheel bolts

- Do not place wheel bolts in sand or on a dirty surface.

- Unscrew the uppermost wheel bolt completely.

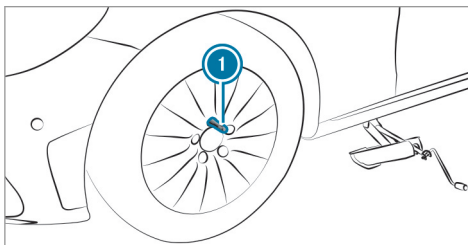

- Screw alignment bolt ① into the thread instead of the wheel bolt.
- Unscrew the remaining wheel bolts completely.
- Remove the wheel.
- Install the new wheel (→ page 384).

## Installing a new wheel

### Requirements

- The wheel to be changed is removed and the alignment bolt is screwed in (→ page 384).

**!** **NOTE** Mercedes-AMG vehicles

- Observe the notes in the Supplement. You could otherwise fail to recognize dangers.

**!** **WARNING** Risk of accident from losing a wheel

Oiled, greased or damaged wheel bolt/wheel nut threads or wheel hub/wheel mounting bolt threads can cause the wheel bolts/wheel nuts to come loose.

- Never oil or grease the threads.
- In the event of damage to the threads, contact a qualified specialist workshop immediately.
- Have the damaged wheel bolts or damaged hub threads replaced.

- ▶ Do not continue driving.

- ▶ Observe the information on the choice of tires (→ page 376).

For tires with a specified direction of rotation, an arrow on the side wall of the tire indicates the correct direction of rotation. Observe the direction of rotation when installing.

- ▶ Slide the wheel to be mounted onto the alignment bolt and push it on.

**⚠ WARNING** Risk of injury from tightening wheel bolts and nuts

If you tighten the wheel bolts or wheel nuts when the vehicle is raised, the jack could tip.

- ▶ Only tighten wheel bolts or wheel nuts when the vehicle is on the ground.

- ▶ Be sure to observe the instructions and safety notes on "Changing a wheel" (→ page 376).
- ▶ For safety reasons, only use wheel bolts which have been approved by Mercedes-Benz and for the wheel in question.

**! NOTE** Damage to paintwork of the wheel rim when screwing in the first wheel bolt

If the wheel has too much play when screwing in the first wheel bolt, the wheel rim paint can be damaged.

- ▶ Press the wheel firmly against the wheel hub when screwing in the first wheel bolt.

- ▶ Tighten the wheel bolts evenly in a diagonal pattern in the order indicated until they are finger-tight.
- ▶ Unscrew and remove the alignment bolt.
- ▶ Tighten the last wheel bolt until it is finger-tight.
- ▶ Lower the vehicle (→ page 385).

### Lowering the vehicle after a wheel change

**Requirements:**

- The new wheel has been installed (→ page 384).

- ▶ **To lower the vehicle:** turn the crank of the jack counter-clockwise until the vehicle is once again standing firmly on the ground.

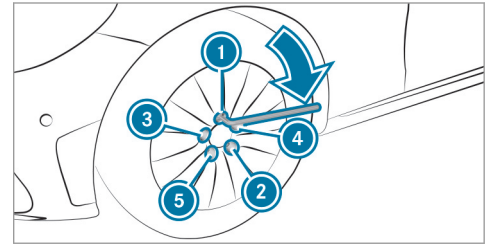

- ▶ Tighten the wheel bolts evenly in a diagonal pattern in the order indicated ① to ⑤ with an initial maximum force of 59 lb-ft (80 Nm).
- ▶ Tighten the wheel bolts evenly in a diagonal pattern in the order indicated ① to ⑤ with the specified tightening torque of 96 lb-ft (130 Nm).

**⚠ WARNING** Risk of accident due to incorrect tightening torque

The wheels could come loose if the wheel bolts or wheel nuts are not tightened to the prescribed torque.

- ▶ Ensure that the wheel bolts or wheel nuts are tightened to the prescribed tightening torque.
- ▶ If you are not sure, do not move the vehicle. Contact a qualified specialist workshop and have the tightening torque checked immediately.

▶ Check the tire pressure of the newly installed wheel and adjust it if necessary.

**i** The following does not apply if the new wheel is an emergency spare wheel.

▶ **Vehicles with tire pressure loss warning system:** Restart the tire pressure loss warning system (→ page 364).

▶ **Vehicles with a tire pressure monitoring system:** Restart the tire pressure monitoring system (→ page 363).

## Emergency spare wheel

### Notes on the emergency spare wheel

**⚠ WARNING** Risk of accident caused by incorrect wheel and tire dimensions

The wheel or tire sizes and the tire type of the emergency spare wheel or spare wheel and the wheel to be replaced may differ. The emergency spare wheel or spare wheel can significantly impair driving characteristics of the vehicle.

To prevent hazardous situations:

- ▶ Drive carefully.
- ▶ Never install more than one emergency spare wheel or spare wheel that differs in size.
- ▶ Only use an emergency spare wheel or spare wheel briefly.
- ▶ Do not deactivate ESP®.
- ▶ Have the emergency spare wheel or spare wheel of a different size replaced at the nearest qualified specialist work-

shop. The new wheel must have the correct dimensions.

**i** The emergency spare wheel is secured in the emergency spare wheel bag in the trunk.

Observe the following notes on installing an emergency spare wheel:

- The maximum permissible speed with an emergency spare wheel installed is 50 mph (80 km/h).
  - Do not install the emergency spare wheel with snow chains.
  - Replace the emergency spare wheel after six years at the latest, regardless of wear.
  - Use the wheel bolts that are included with the emergency spare wheel.
  - Check the tire pressure when the emergency spare wheel is installed. Correct the pressure as necessary.
- i** The specified tire pressure is stated on the label of the emergency spare wheel.

**i Vehicles with a tire pressure loss warning system:** if an emergency spare wheel is installed, the tire pressure loss warning system cannot function reliably. Only restart the system again when the emergency spare wheel has been replaced with a new wheel.

**Vehicles with a tire pressure monitoring system:** if an emergency spare wheel is installed, the tire pressure monitoring system cannot function reliably. For a few minutes after an emergency spare wheel is installed, the system may still display the tire pressure of the removed wheel. Only restart the system again when the emergency spare wheel has been replaced with a new wheel.

Be sure to also observe the following further related subjects:

- Notes on tire pressure (→ page 358)
- Tire and loading information placard (→ page 365)
- Tire pressure table (→ page 360)
- Notes on installing tires (→ page 376)
- Installing an emergency spare wheel (→ page 380)

### Notes on technical data

#### **!** NOTE Mercedes-AMG vehicles

- ▶ Observe the notes in the Supplement. You could otherwise fail to recognize dangers.

The data stated only applies to vehicles with standard equipment. You can obtain further information from an authorized Mercedes-Benz Center.

### Vehicle electronics

#### Two-way radios

##### Notes on installing two-way radios

#### **!** WARNING Risk of accident due to improper work on two-way radios

If two-way radios are manipulated or retrofitted incorrectly, the electromagnetic radiation from the two-way radios can interfere with the vehicle electronics and jeopardize the operating safety of the vehicle.

- ▶ You should have all work on electrical and electronic components carried out at a qualified specialist workshop.

#### **!** WARNING Risk of accident due to improper operation of two-way radios

If you use two-way radios in the vehicle improperly, their electromagnetic radiation can disrupt the vehicle's electronics. This is the case in the following situations, in particular:

- The two-way radio is not connected to an exterior antenna.
- The exterior antenna is installed incorrectly or is not a low-reflection antenna.

This could jeopardize the operating safety of the vehicle.

- ▶ Have the low-reflection exterior antenna installed at a qualified specialist workshop.

- ▶ When operating two-way radios in the vehicle, always connect them to the low-reflection exterior antenna.

#### **!** NOTE Invalidation of the operating permit due to failure to comply with the instructions for installation and use

The operating permit may be invalidated if the instructions for installation and use of two-way radios are not observed.

- ▶ Only use approved frequency bands.
- ▶ Observe the maximum permissible output power in these frequency bands.
- ▶ Only use approved antenna positions.

On vehicles with a panoramic sliding sunroof, installing an antenna in the front or rear roof area is not permitted.

Use Technical Specification ISO/TS 21609 (Road Vehicles - "EMCs for installation of aftermarket radio frequency transmitting equipment") when retrofitting two-way radios. Comply with the legal requirements for detachable parts.

If your vehicle has installing for two-way radio equipment, use the power supply and antenna connectors provided in the pre-installation. Observe the manufacturer's supplements when installing.

#### Two-way radio transmission output

The maximum transmission output (PEAK) at the base of the antenna must not exceed the values in the following table.

#### Frequency band and maximum transmission output

Frequency band	Maximum transmission output
Short wave 3 - 54 MHz	100 W
4 m frequency band 74 - 88 MHz	30 W
2 m frequency band 144 - 174 MHz	50 W

Frequency band	Maximum transmission output
Terrestrial Trunked Radio (TETRA) 380 - 460 MHz	10 W
70 cm frequency band 420 - 450 MHz	35 W
Two-way radio (2G/3G/4G)	10 W

The following can be used in the vehicle without restrictions:

- two-way radios with a maximum transmission output of up to 100 mW
- RF transmitters with transmitter frequencies in the 380 - 410 MHz frequency band and a maximum transmission output of up to 2 W (TETRA)
- mobile phones (2G/3G/4G)

There are no restrictions when positioning the antenna on the outside of the vehicle for the following frequency bands:

- Terrestrial Trunked Radio (TETRA)
- 70 cm frequency band
- 2G/3G/4G

#### Regulatory radio identification and notes

##### Regulatory radio identification of small components

Manufacturer information about radio-based vehicle components can be found using the key phrase "Regulatory radio identification" in the Digital Operator's Manual in the vehicle, on the Internet and in the app.

##### Regulatory radio identification - Indonesia and Israel

Manufacturer information about radio-based vehicle components for Indonesia and Israel can be found using the key phrase "Regulatory radio identification - Indonesia and Israel" in the Digital

Operator's Manual in the vehicle, on the Internet and in the app.

- ① These are not small components. Information about small components can be found using the key phrase "Regulatory radio identification of small components".

### Further component-specific information

Further component-specific information can be found using the key phrase "further component-specific information" in the Digital Operator's Manual in the vehicle, on the Internet and in the app.

### Vehicle identification plate, VIN and engine number overview

#### Vehicle identification plate

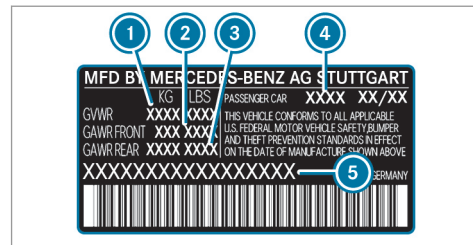
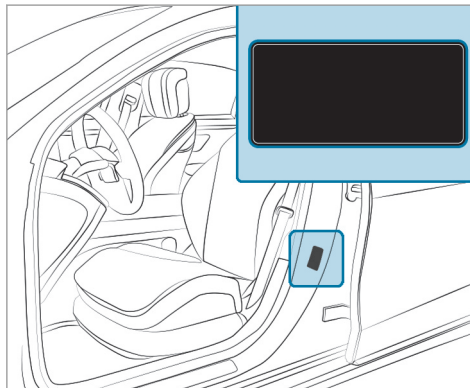

Vehicle identification plate (USA only)

- ① Maximum permissible gross vehicle weight
- ② Maximum permissible front axle load
- ③ Maximum permissible rear axle load
- ④ Paint code
- ⑤ VIN (vehicle identification number)



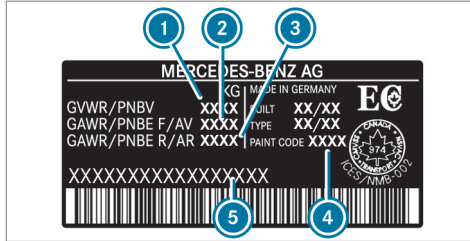

Vehicle identification plate (Canada only)

- ① Maximum permissible gross vehicle weight
- ② Maximum permissible front axle load
- ③ Maximum permissible rear axle load
- ④ Paint code
- ⑤ VIN (vehicle identification number)

The maximum permissible gross vehicle weight is made up of the vehicle weight, all vehicle occupants, the fuel and the load. The maximum gross axle weight rating is the maximum weight that can be carried on one axle (front or rear axle).

Do not exceed the maximum permissible gross vehicle weight or the maximum gross axle weight rating for the front or rear axle.

### VIN below the front right-hand seat

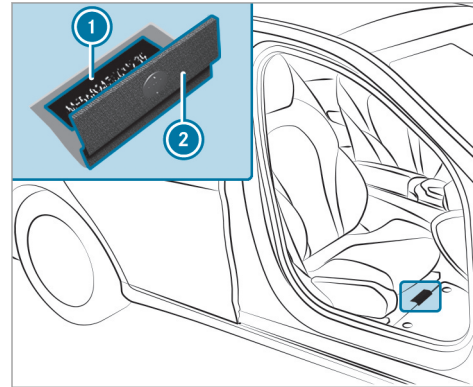

- ① Imprinted VIN (vehicle identification number)
- ② Floor covering

### Additional plates

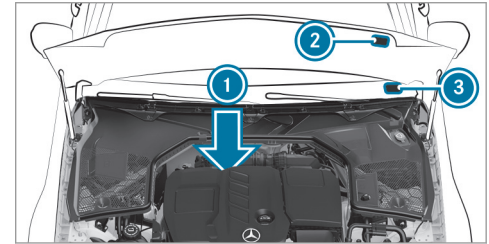

- ① Engine number stamped into the crankcase
- ② Plate with information about emissions testing, including confirmation of emissions guidelines at the U.S. federal level as well as for California
- ③ VIN (vehicle identification number) as a label at the lower edge of the windshield

## Operating fluids

### Notes on operating fluids

#### ! NOTE Mercedes-AMG vehicles

- ▶ Observe the notes in the Supplement. You could otherwise fail to recognize dangers.

#### ⚠ WARNING Risk of injury from operating fluids harmful to your health

Operating fluids may be poisonous and harmful to your health.

- ▶ Observe the text on the original containers when using, storing or disposing of operating fluids.
- ▶ Always store operating fluids sealed in their original containers.
- ▶ Always keep children away from operating fluids.



**ENVIRONMENTAL NOTE** Pollution of the environment due to irresponsible disposal of operating fluids

Incorrect disposal of operating fluids can cause considerable damage to the environment.

- ▶ Dispose of operating fluids in an environmentally responsible manner.

Operating fluids include the following:

- fuels
- lubricants
- Coolant
- Brake fluid
- Windshield washer fluid
- climate control system refrigerant

Only use products approved by Mercedes-Benz. Damage caused by the use of products that have not been approved is not covered by the Mercedes-Benz warranty or goodwill gestures.

The operating fluids approved by Mercedes-Benz can be identified by the following inscriptions on the container:

- MB-Freigabe (e.g. MB-Freigabe 229.51)
- MB-Approval (e.g. MB-Approval 229.51)

Further information on approved operating fluids:

- in the Mercedes-Benz Specifications for Operating Fluids by entering the designation
  - at <https://bevo.mercedes-benz.com>
  - in the Mercedes-Benz BeVo App
- At a qualified specialist workshop

#### ⚠ WARNING Risk of fire or explosion from fuel

Fuels are highly flammable.

- ▶ Fire, open flames, smoking and creating sparks must be avoided.
- ▶ Before and during refueling, switch off the vehicle and, if installed, the stationary heater.

**▲ WARNING** Risk of injury from fuels

Fuels are poisonous and hazardous to your health.

- ▶ Do not swallow fuel or let it come into contact with skin, eyes or clothing.
- ▶ Do not inhale fuel vapor.
- ▶ Keep children away from fuel.
- ▶ Keep doors and windows closed during the refueling process.

If you or other people come into contact with fuel, observe the following:

- ▶ Immediately rinse fuel off your skin with soap and water.
- ▶ If fuel comes into contact with your eyes, immediately rinse them thoroughly with clean water. Seek medical attention immediately.
- ▶ If you swallow fuel, seek medical attention immediately. Do not induce vomiting.

- ▶ Change immediately out of clothing that has come into contact with fuel.

Flexible-fuel vehicles can be refueled with the following fuel types:

- unleaded gasoline
- E85 fuel
- a mixture of E85 fuel and unleaded gasoline

Flexible-fuel vehicles can be identified by the **Ethanol up to E85** sticker on the inside of the fuel filler flap.

Depending on the country, the fuels you can use in your vehicle may differ from the information in the Operator's Manual. The fuels that have been approved for your vehicle can be found on the instruction label on the inside of the fuel filler flap.

### Fuel

#### **Information on fuel quality for vehicles with gasoline engine**

Observe the notes on operating fluids (→ page 392).

**! NOTE** Damage caused by the wrong fuel

Even small amounts of the wrong fuel could result in damage to the fuel system, the engine and the emission control system.

- ▶ Only refuel with low-sulfur spark-ignition engine fuel.

This fuel may contain up to 10% ethanol by volume. Your vehicle is suitable for use with E10 fuel.

Never refuel with one of the following fuels:

- diesel
- Gasoline with more than 10% ethanol by volume, e.g. E15, E85, E100
- Gasoline with more than 3% methanol by volume, e.g. M15, M30, M85, M100
- Gasoline with additives containing metal

If you have accidentally refueled with the wrong fuel:

- ▶ Do not switch on the vehicle.
- ▶ Consult a qualified specialist workshop.

If the available fuel is not sufficiently low in sulfur, it may produce unpleasant odors.

Refuel using only fuel that has at least the octane number specified on the information label on the fuel filler flap (→ page 145).

**For maximum engine output:** refuel using only premium-grade unleaded gasoline with an octane number of at least 91 AKI/95 RON.

Never refuel using gasoline of an even lower RON.

**!** **NOTE** Premature engine wear through unleaded regular gasoline

Impairment of the longevity and performance of the engine.

If unleaded premium grade gasoline is unavailable and you have to refuel using unleaded regular gasoline:

- ▶ Only fill the fuel tank to half full with unleaded regular gasoline and refill as soon as possible with unleaded premium grade gasoline.
- ▶ Do not drive at the maximum design speed.

▶ Avoid sudden acceleration and engine speeds over 3000 rpm.

Further information on fuel is available at the following locations:

- At a gas station
- At a qualified specialist workshop
- On the <https://www.mbusa.com> (USA only)

#### Information on additives in gasoline (vehicles with gasoline engine)

Observe the notes on operating fluids (→ page 392).

**!** **NOTE** Damage from use of unsuitable additives

Even small amounts of the wrong additive may lead to malfunctions occurring.

▶ Only add cleaning additives recommended by Mercedes-Benz to the fuel.

Mercedes-Benz recommends that you use brand-name fuels with additives.

In some countries, the fuel available may not have sufficient additives. Deposits could build up in the fuel injection system as a result. In this case, in consultation with a Mercedes-Benz Service Center, mix the fuel with the cleaning additive recommended by Mercedes-Benz. Observe the notes and mixing ratios indicated on the tank.

#### Tank content and fuel reserve

##### Total fuel tank capacity

Model	
All models	17.4 gal (66.0 liters)

##### Reserve fuel tank

Model	
All models	1.9 gal (7.0 liters)

#### Engine oil

##### Notes on engine oil

Observe the notes on operating fluids (→ page 392).



**!** **NOTE** Engine damage caused by an incorrect oil filter, incorrect oil or additives

- ▶ Do not use engine oils or oil filters other than those which meet the specifications necessary for the prescribed service intervals.
- ▶ Do not alter the engine oil or oil filter in order to achieve longer change intervals than prescribed.
- ▶ Do not use additives.
- ▶ Have the engine oil changed after the prescribed intervals.

Mercedes-Benz recommends having the oil changed at a qualified specialist workshop.

Only use engine oils approved for your vehicle by Mercedes-Benz.

### Quality and capacity of engine oil

#### Engine oil specification

Model	MB-Freigabe or MB-Approval
All models	229.51, 229.52, 229.61, 229.71, 229.72 <sup>1)</sup>
1) Recommended for lowest possible fuel consumption (lowest SAE viscosity class in each case; observe possible restrictions of the approved SAE viscosity classes).	

To achieve the lowest possible fuel consumption, it is recommended to use the engine oil specifications marked in the table for the lowest SAE viscosity class. Possible restrictions of the approved SAE viscosity classes must be observed.

### Engine oil filling capacity

Model	Capacity
C 300	7.0 US qt (6.6 liters)
C 300 4MATIC	6.3 US qt (6.0 liters)

The specified filling capacity refers to an oil change with the oil filter.

### Notes on brake fluid

Observe the notes on operating fluids (→ page 392).

**!** **WARNING** Risk of an accident due to vapor pockets forming in the brake system

The brake fluid constantly absorbs moisture from the air. This lowers the boiling point of the brake fluid. If the boiling point is too low, vapor pockets may form in the brake system when the brakes are applied hard.

This causes the braking effect to be impaired.

- ▶ Have the brake fluid renewed at the specified intervals.

Have the brake fluid regularly replaced at a qualified specialist workshop.

Only use a brake fluid approved by Mercedes-Benz according to MB-Freigabe or MB-Approval 331.0.

## Coolant

### Notes on coolant

Observe the notes on operating fluids (→ page 392).

**⚠ WARNING** – Risk of fire and injury from antifreeze

If antifreeze comes into contact with hot component parts in the engine compartment, it may ignite.

- ▶ Allow the engine to cool down before adding antifreeze.
- ▶ Make sure that no antifreeze spills out next to the filler opening.
- ▶ Thoroughly clean off any antifreeze from component parts before starting the vehicle.

**! NOTE** Damage caused by incorrect coolant

- ▶ Only use coolant that has been premixed with the required antifreeze protection.

Information on coolant is available at the following locations:

- In the Mercedes-Benz Specification for Operating Fluids 320.1
  - At <https://bevo.mercedes-benz.com>
  - In the Mercedes-Benz BeVo app
- At a qualified specialist workshop

**! NOTE** Overheating at high outside temperatures

If an inappropriate coolant is used, the cooling system is not sufficiently protected against overheating and corrosion at high outside temperatures.

- ▶ Only use coolant approved for Mercedes-Benz.

- ▶ Observe the instructions in the Mercedes-Benz Specifications for Operating Fluids 320.1.

Have the coolant regularly replaced at a qualified specialist workshop.

Proportion of antifreeze concentrate in the cooling system:

- A minimum of 50% (antifreeze protection down to about -35°F (-37°C))
- A maximum of 55% (antifreeze protection down to -49°F (-45°C))

### Coolant filling quantity

#### Coolant

Model	Capacity
All models	9.5 US qt (9.0 liters)

### Notes on windshield washer fluid

Observe the notes on operating fluids (→ page 392).

**⚠ WARNING** - Risk of fire and injury from windshield washer concentrate

Windshield washer concentrate is highly flammable. It could ignite if it comes into contact with hot engine component parts or the exhaust system.

- ▶ Make sure that no windshield washer concentrate spills out next to the filler opening.

**! NOTE** Damage to the exterior lighting due to unsuitable windshield washer fluid

Unsuitable windshield washer fluid may damage the plastic surface of the exterior lighting.

- ▶ Only use windshield washer fluid which is also suitable for use on plastic surfaces, e.g. MB SummerFit or MB WinterFit.

**! NOTE** Blocked spray nozzles caused by mixing windshield washer fluids

- ▶ Do not mix MB SummerFit and MB WinterFit with other windshield washer fluids.

Do not use distilled or de-ionised water. Otherwise, the fill level sensor may be triggered erroneously.

Recommended windshield washer fluid:

- Above freezing point: e.g. MB SummerFit
- Below freezing point: e.g. MB WinterFit

For the correct mixing ratio, refer to the information on the antifreeze container.

Mix washing water with windshield washer fluid all year round.

### Refrigerant

#### Notes on refrigerant

Observe the notes on operating fluids (→ page 392).

**! NOTE** Damage due to incorrect refrigerant

If a non-approved refrigerant is used, the climate control system may be damaged.

- ▶ **USA:** use only R-134a refrigerant.
- ▶ **Canada:** use only R-1234yf refrigerant.

**! NOTE** Damage to the climate control system due to incorrect refrigerant compressor oil

- ▶ Only use refrigerant compressor oil that has been approved by Mercedes-Benz.
- ▶ Do not mix the approved refrigerant compressor oil with a different refrigerant compressor oil.

Work on the climate control system may be carried out only at a qualified specialist workshop. All applicable regulations as well as SAE standard J639 must be adhered to.

The information label for the climate control system regarding the refrigerant type and the refrigerant compressor oil (PAG oil) is located on the inside of the hood.

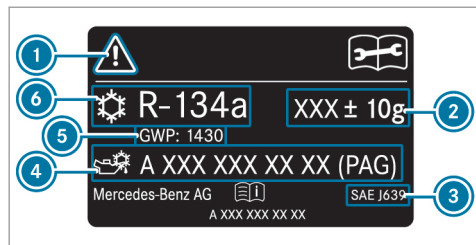

Information label (example – USA)

- ① Hazard and service warning symbols
- ② Refrigerant filling capacity
- ③ Applicable standards
- ④ PAG oil part number
- ⑤ GWP (global warming potential) of the refrigerant used
- ⑥ Refrigerant type

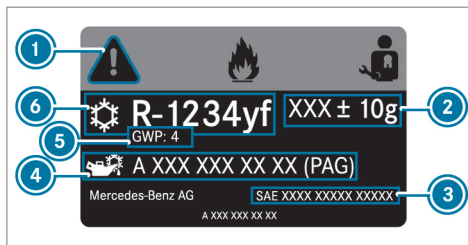

Information label (example – Canada)

- ① Hazard and service warning symbols
- ② Refrigerant filling capacity
- ③ Applicable standards
- ④ PAG oil part number
- ⑤ GWP (global warming potential) of the refrigerant used
- ⑥ Refrigerant type

Symbols ① indicate the following:

- Possible dangers
- Having maintenance work carried out at a qualified specialist workshop

### Filling capacity for refrigerant and PAG oil

#### Refrigerant filling capacity

Model	
All models	22.2 ± 0.4 oz (630 ± 10 g)

#### Filling capacity for PAG oil

Model	
All models	2.8 ± 0.4 oz (80 ± 10 g)

### Vehicle data

#### Vehicle dimensions

The heights specified may vary as a result of the following factors:

- tires
- load
- condition of the suspension
- optional equipment



**Vehicle dimensions**

All models	
Vehicle length	184.5 in (4686 mm)
Vehicle width including outside mirrors	79.4 in (2016 mm)
Wheelbase	111.8 in (2840 mm)

**Vehicle height**

Model	
C 300	55.3 in (1405 mm)
C 300 4MATIC	55.6 in (1413 mm)

**Turning circle**

Model	
C 300	36.81 ft (11.22 m)
C 300 4MATIC	37.57 ft (11.45 m)

**Weights and loads**

Bear in mind that items of optional equipment increase the curb weight and reduce the payload. Vehicle-specific weight information can be found on the vehicle identification plate.

**Maximum design speeds****Not for Mercedes-AMG vehicles:**

Missing values were not available at the time of going to press.

**Maximum permissible speed**

All models	
------------	--

## Display messages

### Introduction



#### Information about display messages

Display messages appear on the instrument display.

Display messages with graphic symbols are shown in a simplified form in the Operator's Manual and may differ from the symbols on the instrument display. The instrument display shows high-priority display messages in red. Certain display messages are accompanied by a warning tone.

Please act in accordance with the display messages and follow the additional notes in the Operator's Manual.

For some display messages, symbols will also be shown:

-  Further information
-  Hide display message

With the left-hand Touch Control, you can select the respective symbol by swiping to the left or right. Pressing  displays further information on

the media display. Press the  symbol to hide the display message.

You can hide low-priority display messages by pressing the back button  or the left-hand Touch Control. The display messages will then be stored in the message memory.

Rectify the cause of a display message as quickly as possible.

High-priority display messages cannot be hidden. The instrument display will show these display messages permanently until the cause of the display message has been rectified.



#### Calling up saved display messages

On-board computer:



 [Service](#)  [1 Message](#)

If there are no display messages, [No Messages](#) will appear on the instrument display.

 Scroll through the display messages by swiping upwards or downwards on the left-hand Touch Control.

 **To exit the message memory:** press the back button .

## Occupant safety

Display messages	Possible causes/consequences and ► Solutions
 <p data-bbox="194 378 443 429">SRS Malfunction Service Required</p>	<p data-bbox="526 284 1053 315">* The restraint system is malfunctioning (→ page 37).</p> <div data-bbox="545 331 1690 445" style="border: 1px solid gray; padding: 5px;"> <p data-bbox="554 336 1265 367"><b>▲ WARNING</b> Risk of injury due to malfunctions in the restraint system</p> <p data-bbox="554 372 1635 404">Components in the restraint system may be activated unintentionally or not deploy as planned in an accident.</p> <p data-bbox="554 409 1524 440">► Have the restraint system checked and repaired immediately at a qualified specialist workshop.</p> </div>
 <p data-bbox="194 554 471 606">Front Left Malfunction Service Required (example)</p>	<p data-bbox="526 461 1201 492">* The corresponding restraint system is malfunctioning (→ page 37).</p> <div data-bbox="545 507 1690 621" style="border: 1px solid gray; padding: 5px;"> <p data-bbox="554 512 1265 543"><b>▲ WARNING</b> Risk of injury due to malfunctions in the restraint system</p> <p data-bbox="554 549 1635 580">Components in the restraint system may be activated unintentionally or not deploy as planned in an accident.</p> <p data-bbox="554 585 1524 616">► Have the restraint system checked and repaired immediately at a qualified specialist workshop.</p> </div>
 <p data-bbox="194 730 443 813">Left Side Curtain Airbag Malfunction Service Required (example)</p>	<p data-bbox="526 637 1201 668">* The corresponding restraint system is malfunctioning (→ page 37).</p> <div data-bbox="545 683 1690 823" style="border: 1px solid gray; padding: 5px;"> <p data-bbox="554 688 1469 720"><b>▲ WARNING</b> Risk of injury or fatal injury due to a malfunction in the window curtain airbag</p> <p data-bbox="554 725 1635 782">The window curtain airbag might be triggered unintentionally or might not be triggered at all in the event of an accident.</p> <p data-bbox="554 787 1580 818">► Have the window curtain airbag checked and repaired immediately at a qualified specialist workshop.</p> </div>

Display messages	Possible causes/consequences and ► Solutions
<p>Front Passenger Airbag Disabled See Operator's Manual</p>	<p>* The front passenger airbag and the front passenger knee airbag have been disabled even though an adult or a person of adult build is on the front passenger seat. If additional forces are applied to the seat, the weight the system detects may be too low.</p> <div data-bbox="495 342 1646 550" style="border: 1px solid gray; padding: 5px;"> <p><b>▲ WARNING</b> Risk of injury or fatal injury due to a disabled front passenger airbag</p> <p>If the front passenger airbag is disabled, the front passenger airbag will not be deployed in the event of an accident and cannot perform its intended protective function.</p> <p>A person in the front passenger seat could then, for example, come into contact with the vehicle's interior, especially if the person is sitting too close to the cockpit.</p> <p>► Make sure, both before and during the journey, that the status of the front passenger airbag is correct.</p> </div> <ul style="list-style-type: none"> <li>► Stop the vehicle immediately in accordance with the traffic conditions.</li> <li>► Make sure that no objects are trapped under the front passenger seat.</li> <li>► Check the status of automatic front passenger airbag shutoff (→ page 47).</li> <li>► If necessary, consult a qualified specialist workshop immediately.</li> </ul>
<p>Front Passenger Airbag Enabled See Operator's Manual</p>	<p>* The front passenger airbag and the front passenger knee airbag will be enabled while the vehicle is in motion in the following situations:</p> <ul style="list-style-type: none"> <li>• Even when a child, a person of smaller stature or an object weighing less than the system weight threshold is located on the front passenger seat</li> <li>• Even when the front passenger seat is not occupied</li> </ul>

Display messages	Possible causes/consequences and ► Solutions
	<p>The system may detect objects or forces that are adding to the weight applied to the seat.</p> <p><b>▲ WARNING</b> Risk of injury or death when using a child restraint system while the front passenger airbag is enabled</p> <p>If you secure a child in a child restraint system on the front passenger seat and the front passenger airbag is enabled, the front passenger airbag can deploy in the event of an accident. The child could be struck by the airbag.</p> <p>► Ensure, both before and during the journey, that the status of the front passenger airbag is correct.</p> <p>NEVER use a rearward facing child restraint on a seat protected by an ACTIVE AIRBAG in front of it, DEATH or SERIOUS INJURY to the CHILD can occur.</p> <p>► Stop the vehicle immediately in accordance with the traffic conditions.          ► Make sure that no objects are trapped under the front passenger seat.          ► Check the status of automatic front passenger airbag shutoff (→ page 47).          ► If necessary, consult a qualified specialist workshop immediately.</p>
PRE-SAFE Inoperative See Operator's Manual	<p>* The PRE-SAFE® functions are malfunctioning.</p> <p>► Consult a qualified specialist workshop.</p>

## SmartKey

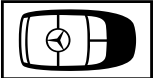
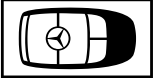
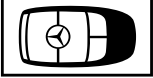
Display messages	Possible causes/consequences and ► Solutions
 <p data-bbox="144 381 325 407">Obtain a New Key</p>	<ul style="list-style-type: none"> <li data-bbox="469 291 778 317">* Have the SmartKey replaced.</li> <li data-bbox="493 324 883 350">► Visit a qualified specialist workshop.</li> </ul>
 <p data-bbox="144 524 349 550">Replace Key Battery</p>	<ul style="list-style-type: none"> <li data-bbox="469 434 846 459">* The SmartKey battery is discharged.</li> <li data-bbox="493 467 861 493">► Replace the battery (→ page 65).</li> </ul>
 <p data-bbox="144 667 389 718">Key Not Detected (white display message)</p>	<ul style="list-style-type: none"> <li data-bbox="469 577 866 602">* The SmartKey is currently undetected.</li> <li data-bbox="493 610 1031 636">► Change the location of the SmartKey in the vehicle.</li> <li data-bbox="493 643 1530 669">► If the SmartKey is still not recognized, place it in the slot for starting with the SmartKey (→ page 130).</li> </ul>

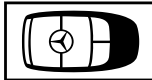
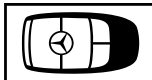

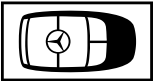

Display messages	Possible causes/consequences and ► Solutions
 <p data-bbox="194 341 471 393"><b>Key Not Detected</b> (Red display message)</p>	<p data-bbox="526 248 1238 274">* The SmartKey cannot be detected and may no longer be in the vehicle.</p> <p data-bbox="545 284 1247 310">If the SmartKey is no longer in the vehicle and you switch off the vehicle:</p> <ul data-bbox="554 321 942 378" style="list-style-type: none"> <li data-bbox="554 321 924 347">• You can no longer start the vehicle.</li> <li data-bbox="554 352 942 378">• You cannot centrally lock the vehicle.</li> </ul> <p data-bbox="545 393 997 419">► Ensure that the SmartKey is in the vehicle.</p> <p data-bbox="545 445 1090 471">If the SmartKey is in the vehicle and still not recognized:</p> <ul data-bbox="545 481 1589 538" style="list-style-type: none"> <li data-bbox="545 481 1589 507">► Pull over and stop the vehicle safely as soon as possible, paying attention to road and traffic conditions.</li> <li data-bbox="545 512 1432 538">► Place the SmartKey in the slot for starting the engine with the SmartKey (→ page 130).</li> </ul> <p data-bbox="545 564 979 590">The SmartKey battery is weak or discharged.</p> <ul data-bbox="545 600 1136 657" style="list-style-type: none"> <li data-bbox="545 600 1136 626">► Check the battery using the indicator lamp (→ page 63).</li> <li data-bbox="545 631 1136 657">► Replace the SmartKey battery, if necessary (→ page 65).</li> </ul>
 <p data-bbox="194 766 471 818"><b>Key Being Initialized Please Wait</b></p>	<p data-bbox="526 673 1173 699">* The vehicle is processing in order to teach in the new SmartKey.</p> <ul data-bbox="545 709 914 735" style="list-style-type: none"> <li data-bbox="545 709 914 735">► Wait until processing is complete.</li> </ul>



Display messages	Possible causes/consequences and ► Solutions
 <p data-bbox="144 339 369 366">Don't Forget Your Key</p>	<p data-bbox="473 249 1641 276">* A warning tone will also sound. This message reminds you to take your SmartKey with you when you leave the vehicle.</p>
<p data-bbox="144 388 412 467">Place the Key in the Marked Space See Operator's Manual</p>	<p data-bbox="473 388 864 415">* SmartKey detection is malfunctioning.</p> <ul style="list-style-type: none"> <li data-bbox="495 422 1031 449">► Change the location of the SmartKey in the vehicle.</li> <li data-bbox="495 456 1483 483">► Place the SmartKey in the marked space for starting the engine with the SmartKey (→ page 130).</li> </ul>

## Lights

Display messages	Possible causes/consequences and ► Solutions
 <p data-bbox="144 717 306 771">Check Left Low Beam (example)</p>	<p data-bbox="473 627 920 654">* The corresponding light source is defective.</p> <ul style="list-style-type: none"> <li data-bbox="495 662 707 688">► Drive on carefully.</li> <li data-bbox="495 696 1005 723">► Visit a qualified specialist workshop immediately.</li> </ul> <p data-bbox="495 730 1637 780">ⓘ LED light sources: the display message for the corresponding light appears only when all the light-emitting diodes in the light are faulty.</p>







Display messages	Possible causes/consequences and ► Solutions
 <p data-bbox="195 341 436 388">Malfunction See Operator's Manual</p>	<ul style="list-style-type: none"> <li>* The exterior lighting is malfunctioning.           <ul style="list-style-type: none"> <li>► Consult a qualified specialist workshop.</li> </ul> </li> </ul>
 <p data-bbox="195 512 471 559">Automatic Headlamp Mode Inoperative</p>	<ul style="list-style-type: none"> <li>* The light sensor for automatic driving lights is malfunctioning.           <ul style="list-style-type: none"> <li>► Consult a qualified specialist workshop.</li> </ul> </li> </ul>
 <p data-bbox="195 678 467 725">Active Headlamps Inoperative</p>	<ul style="list-style-type: none"> <li>* The active headlamps are malfunctioning.           <ul style="list-style-type: none"> <li>► Consult a qualified specialist workshop.</li> </ul> </li> </ul>
 <p data-bbox="195 844 421 865">Switch On Headlamps</p>	<ul style="list-style-type: none"> <li>* You are driving without low-beam headlamps.           <ul style="list-style-type: none"> <li>► Turn the light switch to the  or <b>AUTO</b> position.</li> </ul> </li> </ul>

Display messages	Possible causes/consequences and ► Solutions
 <p>Switch Off Lights</p>	<ul style="list-style-type: none"> <li>* You are leaving the vehicle and the lights are still switched on.               <ul style="list-style-type: none"> <li>► Turn the light switch to the <b>AUTO</b> position.</li> </ul> </li> </ul>
 <p>Intell. Light System Inoperative</p>	<ul style="list-style-type: none"> <li>* The Intelligent Light System is malfunctioning. The lighting system continues to function properly without the functions of the Intelligent Light System.               <ul style="list-style-type: none"> <li>► Consult a qualified specialist workshop.</li> </ul> </li> </ul>
<p>Adaptive Highbeam Assist Currently Unavailable See Operator's Manual</p>	<ul style="list-style-type: none"> <li>* Adaptive Highbeam Assist is temporarily unavailable. The system limits have been reached (→ page 115). Once the cause of the problem is no longer present, the system will be available again. The <b>Adaptive Highbeam Assist Now Available</b> display message will appear.               <ul style="list-style-type: none"> <li>► Drive on.</li> <li>► Operate the high beam manually until Adaptive High Beam Assist is available again.</li> </ul> </li> </ul>
<p>Adaptive Highbeam Assist Inoperative</p>	<ul style="list-style-type: none"> <li>* Adaptive Highbeam Assist is malfunctioning.               <ul style="list-style-type: none"> <li>► Drive on.</li> </ul>               or             </li> </ul>



Display messages	Possible causes/consequences and ► Solutions
	<ul style="list-style-type: none"> <li>► Stop the vehicle in accordance with the traffic conditions and restart the vehicle.</li> <li>► If the display message does not disappear: consult a qualified specialist workshop.</li> <li>► Until then, operate the high beam manually.</li> </ul>
<p>Adaptive Highbeam Assist Camera View Restricted See Operator's Manual</p>	<p>* The camera view is restricted. Possible causes:</p> <ul style="list-style-type: none"> <li>• Dirt on the windshield in the camera's field of vision</li> <li>• Heavy rain, snow or fog</li> </ul> <p>Driving systems and driving safety systems may be malfunctioning or temporarily unavailable.</p> <p>Once the cause of the problem is no longer present, the driving systems and driving safety systems will be available again.</p> <p>If the display message does not disappear:</p> <ul style="list-style-type: none"> <li>► Stop the vehicle in accordance with the traffic conditions.</li> <li>► Clean the windshield.</li> </ul>
<p>Hazard Warning Flashers Malfunctioning</p>	<p>* The hazard warning lamp switch is malfunctioning.</p> <ul style="list-style-type: none"> <li>► Consult a qualified specialist workshop.</li> </ul>

## Vehicle

Display messages	Possible causes/consequences and ► Solutions
 <p data-bbox="144 381 373 458">Vehicle Ready to Drive Switch the Ignition Off Before Exiting</p>	<p data-bbox="473 288 994 313">* You are leaving the vehicle in a ready-to-drive state.</p> <ul style="list-style-type: none"> <li data-bbox="495 324 1350 350">► Get out of the vehicle, secure it against rolling away and take the SmartKey with you.</li> <li data-bbox="495 360 1637 412">► If you do not leave the vehicle, switch off the electrical consumers, e.g. the seat heating. Otherwise, the 12-V battery may discharge and starting the engine may be possible only with the help of a second battery (jump start).</li> </ul>
<p data-bbox="144 482 421 560">Head-up Display Currently Unavailable See Operator's Manual</p>	<p data-bbox="473 482 1119 508">* The Head-up Display is temporarily unavailable. Possible causes:</p> <ul style="list-style-type: none"> <li data-bbox="500 519 851 544">• Malfunctions in the power supply</li> <li data-bbox="500 555 713 581">• Signal interference</li> </ul> <ul style="list-style-type: none"> <li data-bbox="495 596 1363 622">► Stop in accordance with the traffic conditions and switch the vehicle off and on again.</li> <li data-bbox="495 632 1262 658">► If the display message still appears, consult a qualified specialist workshop.</li> </ul>
<p data-bbox="144 671 402 717">Head-up Display Inopera- tive</p>	<p data-bbox="473 671 901 697">* The Head-up Display has an internal error.</p> <ul style="list-style-type: none"> <li data-bbox="495 707 916 733">► Consult a qualified specialist workshop.</li> </ul>

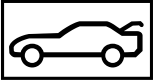
Display messages	Possible causes/consequences and ► Solutions
 <p data-bbox="194 341 452 419">Steering Malfunction Increased Physical Effort See Operator's Manual</p>	<p data-bbox="526 248 1016 274">* The power steering assistance is malfunctioning.</p> <div data-bbox="545 290 1690 440" style="border: 1px solid gray; padding: 5px;"> <p data-bbox="554 295 1275 326"><b>⚠ WARNING</b> Risk of an accident due to altered steering characteristics</p> <p data-bbox="554 336 1607 367">If the power assistance of the steering fails partially or completely, you will need to use more force to steer.</p> <ul style="list-style-type: none"> <li data-bbox="554 372 1034 398">▶ If safe steering is possible, drive on carefully.</li> <li data-bbox="554 404 1182 429">▶ Visit or consult a qualified specialist workshop immediately.</li> </ul> </div>
 <p data-bbox="194 549 462 626">Steering Malfunction Stop Immediately See Operator's Manual</p>	<p data-bbox="526 455 1265 481">* The steering is malfunctioning. Steering capability is significantly impaired.</p> <div data-bbox="545 497 1690 678" style="border: 1px solid gray; padding: 5px;"> <p data-bbox="554 502 1182 533"><b>⚠ WARNING</b> Risk of accident if steering capability is impaired</p> <p data-bbox="554 543 1441 574">If the steering does not function as intended, the vehicle's operating safety is jeopardized.</p> <ul style="list-style-type: none"> <li data-bbox="554 580 1644 637">▶ Pull over and stop the vehicle safely as soon as possible, paying attention to road and traffic conditions. Do not continue driving under any circumstances.</li> <li data-bbox="554 642 988 668">▶ Consult a qualified specialist workshop.</li> </ul> </div>
	<p data-bbox="526 694 803 720">* At least one door is open.</p> <ul style="list-style-type: none"> <li data-bbox="545 725 739 751">▶ Close all doors.</li> </ul>



Display messages	Possible causes/consequences and ► Solutions
	<p>* The hood is open.</p> <p><b>▲ WARNING</b> Risk of accident due to driving with the hood unlocked</p> <p>The hood may open and block your view.</p> <ul style="list-style-type: none"><li>▶ Never release the hood when driving.</li><li>▶ Before every trip, ensure that the hood is locked.</li></ul> <p>► Stop the vehicle immediately in accordance with the traffic conditions.</p> <p>► Close the hood.</p>
	<p>* The trunk lid is open.</p> <p><b>▲ DANGER</b> Risk of exhaust gas poisoning</p> <p>Combustion engines emit poisonous exhaust gases such as carbon monoxide. Exhaust gases can enter the vehicle interior if the trunk lid is open when the engine is running, especially if the vehicle is in motion.</p> <ul style="list-style-type: none"><li>▶ Always switch off the engine before opening the trunk lid.</li><li>▶ Never drive with the trunk lid open.</li></ul> <p>► Close the trunk lid.</p>



Display messages	Possible causes/consequences and ► Solutions
 <p data-bbox="195 339 426 391">Rear Left Backrest Not Latched (example)</p>	<ul style="list-style-type: none"> <li>* The seat backrest of the corresponding seat is not engaged.               <ul style="list-style-type: none"> <li>► Fold the seat backrest back until it engages.</li> </ul> </li> </ul>
 <p data-bbox="195 510 445 562">Front Left Seat Backrest Not Locked (example)</p>	<ul style="list-style-type: none"> <li>* The seat backrest of the corresponding front seat is not engaged.               <ul style="list-style-type: none"> <li>► Fold the seat backrest back until it engages.</li> </ul> </li> </ul>
 <p data-bbox="195 681 399 702">Check Washer Fluid</p>	<ul style="list-style-type: none"> <li>* The washer fluid level in the washer fluid reservoir has dropped below the minimum.               <ul style="list-style-type: none"> <li>► Add washer fluid (→ page 327).</li> </ul> </li> </ul>
<p data-bbox="195 728 412 749">Wiper Malfunctioning</p>	<ul style="list-style-type: none"> <li>* The windshield wipers are malfunctioning.               <ul style="list-style-type: none"> <li>► Restart the vehicle.</li> </ul> </li> <li>If the display message still appears:               <ul style="list-style-type: none"> <li>► Consult a qualified specialist workshop.</li> </ul> </li> </ul>

## Engine

Display messages	Possible causes/consequences and ► Solutions
<p>To switch engine off, press and hold Start/Stop button for at least 3 secs. or press 3 times.</p>	<ul style="list-style-type: none"> <li>* You have pressed the start/stop button while the vehicle is in motion.                             <ul style="list-style-type: none"> <li>► Information about switching off the vehicle while driving (→ page 129).</li> </ul> </li> </ul>
<p>Cannot Start Engine See Operator's Manual</p>	<ul style="list-style-type: none"> <li>* The vehicle cannot be started.                             <ul style="list-style-type: none"> <li>► Switch the vehicle off and switch it back on</li> <li>► If the display message still appears, consult a qualified specialist workshop.</li> </ul> </li> </ul>
<div style="text-align: center;">  </div> <p>Check Coolant Level See Operator's Manual</p>	<ul style="list-style-type: none"> <li>* The coolant level is too low.                             <div style="border: 1px solid gray; padding: 5px; margin: 10px 0;"> <p><b>!</b> <b>NOTE</b> Engine damage due to insufficient coolant</p> <ul style="list-style-type: none"> <li>► Avoid long journeys with insufficient coolant.</li> </ul> </div> <ul style="list-style-type: none"> <li>► Add coolant (→ page 327).</li> <li>► Have the engine cooling system checked at a qualified specialist workshop.</li> </ul> </li> </ul>



Display messages	Possible causes/consequences and ► Solutions
 <p data-bbox="199 343 471 391">Coolant Too Hot Stop Vehicle Turn Engine Off</p>	<p data-bbox="526 250 766 274">* The coolant is too hot.</p> <ul style="list-style-type: none"> <li data-bbox="545 284 1413 308">► Stop immediately in accordance with the traffic conditions and switch off the vehicle.</li> </ul> <div data-bbox="545 336 1690 585" style="border: 1px solid gray; padding: 5px;"> <p data-bbox="563 343 1081 367"><b>⚠ WARNING</b> Risk of burns when opening the hood</p> <p data-bbox="563 383 1653 429">If you open the hood in the event of an overheated engine or fire in the engine compartment, the following situations may occur:</p> <ul style="list-style-type: none"> <li data-bbox="572 445 1016 469">• You may come into contact with hot gases.</li> <li data-bbox="572 479 1265 503">• You may come into contact with other escaping hot operating fluids.</li> </ul> <ul style="list-style-type: none"> <li data-bbox="563 523 1155 547">► Before opening the hood, allow the engine to cool down.</li> <li data-bbox="563 557 1524 581">► In the event of a fire in the engine compartment, keep the hood closed and call the fire service.</li> </ul> </div> <ul style="list-style-type: none"> <li data-bbox="545 606 960 629">► Wait until the engine has cooled down.</li> <li data-bbox="545 640 1191 664">► Make sure that the air supply to the radiator is not obstructed.</li> <li data-bbox="545 674 1672 725">► Avoiding high loads on the engine, drive to the nearest qualified specialist workshop. In doing so, ensure that the coolant temperature display remains below the red marking.</li> </ul>
	<p data-bbox="526 742 1053 766">* There is a malfunction in the engine cooling system.</p> <ul style="list-style-type: none"> <li data-bbox="545 777 1672 827">► Avoiding high loads on the engine, drive to the nearest qualified specialist workshop. In doing so, ensure that the coolant temperature display remains below the red marking.</li> </ul>

Display messages	Possible causes/consequences and ► Solutions
 <p>Fuel Level Low</p>	<ul style="list-style-type: none"> <li>* The fuel supply has dropped into the reserve range.               <ul style="list-style-type: none"> <li>► Refuel.</li> </ul> </li> </ul>
 <p>Gas Cap Loose</p>	<ul style="list-style-type: none"> <li>* The fuel filler cap is not closed correctly or the fuel system is leaking.               <ul style="list-style-type: none"> <li>► Close the fuel filler cap.</li> <li>► <b>If the fuel filler cap was already properly closed:</b> consult a qualified specialist workshop.</li> </ul> </li> </ul>

### Transmission

Display messages	Possible causes/consequences and ► Solutions
<p>Only Shift to 'P' when Vehicle is Stationary</p>	<ul style="list-style-type: none"> <li>* It is possible to select the park position <b>P</b> only if the vehicle is stationary.               <ul style="list-style-type: none"> <li>► Depress the brake pedal to stop.</li> <li>► Shift the transmission to park position <b>P</b> when the vehicle is stationary.</li> </ul> </li> </ul>
<p>Apply Brake to Shift from 'P'</p>	<ul style="list-style-type: none"> <li>* You have attempted to shift the transmission out of park position <b>P</b> and into another transmission position.               <ul style="list-style-type: none"> <li>► Depress the brake pedal.</li> <li>► Select transmission position <b>D</b>, <b>R</b> or neutral <b>N</b>.</li> </ul> </li> </ul>



Display messages	Possible causes/consequences and ► Solutions
To Deselect P or N, Depress Brake and Start Engine	<ul style="list-style-type: none"> <li>* You have attempted to shift the transmission out of park position <b>P</b> or neutral <b>N</b> and into another transmission position.               <ul style="list-style-type: none"> <li>► Depress the brake pedal.</li> <li>► Start the vehicle.</li> <li>► Change the transmission position.</li> </ul> </li> </ul>
Apply Brake to Shift to 'R'	<ul style="list-style-type: none"> <li>* You have attempted to select transmission position <b>R</b>.               <ul style="list-style-type: none"> <li>► Depress the brake pedal.</li> <li>► Select transmission position <b>R</b>.</li> </ul> </li> </ul>
Driver's Door Open & Transmission Not in P Risk of Vehicle Rolling Away	<ul style="list-style-type: none"> <li>* The driver's door is not fully closed and transmission position <b>D</b>, <b>R</b> or neutral <b>N</b> is selected. The vehicle may roll away.               <ul style="list-style-type: none"> <li>► Select park position <b>P</b> when switching off the vehicle.</li> </ul> </li> </ul>
N Permanently Active Risk of Rolling Away	<ul style="list-style-type: none"> <li>* While the vehicle is rolling or while you are driving, neutral <b>N</b> has been engaged.               <ul style="list-style-type: none"> <li>► Depress the brake pedal to stop.</li> <li>► Shift the transmission to park position <b>P</b> when the vehicle is stationary.</li> <li>► To continue driving, select transmission position <b>D</b> or <b>R</b>.</li> </ul> </li> </ul>
Service Required Do Not Shift Gears Visit Dealer	<ul style="list-style-type: none"> <li>* The transmission is malfunctioning. It is no longer possible to change the transmission position.               <ul style="list-style-type: none"> <li>► If transmission position <b>D</b> is selected, consult a qualified specialist workshop and do not change the transmission position.</li> </ul> </li> </ul>





## 418 Display messages and warning/indicator lamps



Display messages	Possible causes/consequences and ► Solutions
	<ul style="list-style-type: none"> <li>► For all other transmission positions, park the vehicle safely.</li> <li>► Consult a qualified specialist workshop or breakdown service.</li> </ul>
Reversing Not Possible Service Required	<ul style="list-style-type: none"> <li>* The transmission is malfunctioning. It is not possible to select transmission position <b>R</b>.</li> <li>► Consult a qualified specialist workshop.</li> </ul>
Transmission Malfunction Stop	<ul style="list-style-type: none"> <li>* The transmission is malfunctioning. The transmission shifts to neutral <b>N</b> automatically.</li> <li>► Stop the vehicle immediately in accordance with the traffic conditions.</li> <li>► Depress the brake pedal.</li> <li>► Engage park position <b>P</b>.</li> <li>► Consult a qualified specialist workshop.</li> </ul>
Stop Vehicle Leave Engine Running Wait Transmission Cooling	<ul style="list-style-type: none"> <li>* The transmission is overheating. Pulling away may be temporarily impaired or not possible.</li> <li>► Stop the vehicle immediately in accordance with the traffic conditions. Do not continue driving.</li> <li>► Leave the engine running.</li> <li>► Wait until the display message disappears before pulling away.</li> </ul>
Auxiliary Battery Malfunc- tion (white display message)	<ul style="list-style-type: none"> <li>* The auxiliary battery for the automatic transmission is no longer being charged.</li> <li>► Visit a qualified specialist workshop.</li> <li>► Until then, always select park position <b>P</b> manually before you switch off the vehicle.</li> <li>► Before leaving the vehicle, apply the electric parking brake.</li> </ul>

Display messages	Possible causes/consequences and ► Solutions
<p>Auxiliary Battery Malfunction (red display message)</p>	<p>* The auxiliary battery for the transmission is no longer being charged.</p> <ul style="list-style-type: none"> <li>► Consult a qualified specialist workshop.</li> <li>► Until then, always select park position <b>P</b> manually before you switch off the vehicle.</li> <li>► Before leaving the vehicle, apply the electric parking brake.</li> </ul>





## Brakes

Display messages	Possible causes/consequences and ► Solutions
<div data-bbox="203 523 360 606" style="border: 1px solid black; padding: 5px; text-align: center; font-weight: bold; font-size: 1.2em;">PARK</div> <p>(USA only)</p> <div data-bbox="203 647 360 730" style="border: 1px solid black; padding: 5px; text-align: center; font-weight: bold; font-size: 1.2em;">(P)</div> <p>(Canada only)</p> <p>Parking Brake See Operator's Manual</p>	<p>* The yellow  indicator lamp is lit. The electric parking brake is malfunctioning.</p> <p><b>To apply:</b></p> <ul style="list-style-type: none"> <li>► Switch the vehicle off and switch it back on</li> <li>► Apply the electric parking brake manually (→ page 153).</li> </ul> <p>If it is not possible to apply the electric parking brake:</p> <ul style="list-style-type: none"> <li>► Visit a qualified specialist workshop.</li> <li>► Where necessary, also secure the parked vehicle against rolling away.</li> </ul> <p>* The yellow  indicator lamp and the red <b>PARK</b> (USA only) or  (Canada only) indicator lamp are lit. The electric parking brake is malfunctioning.</p> <p><b>To release:</b></p>







Display messages	Possible causes/consequences and ► Solutions
	<ul style="list-style-type: none"><li>► Switch the vehicle off and switch it back on</li><li>► Release the electric parking brake manually (→ page 153).</li></ul> or <ul style="list-style-type: none"><li>► Release the electric parking brake automatically (→ page 152).</li></ul> If it is still not possible to release the electric parking brake: <ul style="list-style-type: none"><li>► Do not continue driving. Consult a qualified specialist workshop.</li></ul> * The yellow  indicator lamp is lit and the red  (USA only) or  (Canada only) indicator lamp is flashing. The electric parking brake is malfunctioning. The electric parking brake could not be applied or released. <ul style="list-style-type: none"><li>► Switch the vehicle off and switch it back on</li></ul> <b>To apply:</b> <ul style="list-style-type: none"><li>► Release and then apply the electric parking brake manually (→ page 153).</li></ul> <b>To release:</b> <ul style="list-style-type: none"><li>► Apply and then release the electric parking brake manually.</li></ul> If the electric parking brake cannot be applied or the red  (USA only) or  (Canada only) indicator lamp continues to flash: <ul style="list-style-type: none"><li>► Do not continue driving. Consult a qualified specialist workshop.</li><li>► Where necessary, also secure the parked vehicle against rolling away.</li></ul>

Display messages	Possible causes/consequences and ► Solutions
	<p>* The yellow  indicator lamp is lit and the red  (USA only) or  (Canada only) indicator lamp flashes for approximately ten seconds after the electric parking brake has been applied or released. It then remains lit or goes out. The electric parking brake is malfunctioning.</p> <p><b>If the condition of charge is too low:</b></p> <ul style="list-style-type: none"><li>► Charge the 12 V battery.</li></ul> <p><b>To apply:</b></p> <ul style="list-style-type: none"><li>► Switch off the vehicle. The electric parking brake will be applied automatically.</li></ul> <p>If you do not want the electric parking brake to be applied, e.g. at an automatic car wash or when the vehicle is being towed, leave the vehicle switched on. This does not include having the vehicle towed with the rear axle raised.</p> <p>If the electric parking brake is not applied automatically:</p> <ul style="list-style-type: none"><li>► Switch the vehicle off and switch it back on</li><li>► Release and then apply the electric parking brake manually (→ page 153).</li></ul> <p>If it is still not possible to apply the electric parking brake:</p> <ul style="list-style-type: none"><li>► Visit a qualified specialist workshop.</li><li>► Where necessary, also secure the parked vehicle against rolling away.</li></ul> <p><b>To release:</b></p>

## 422 Display messages and warning/indicator lamps

Display messages	Possible causes/consequences and ► Solutions
	<ul style="list-style-type: none"><li>► If the conditions for automatic release are fulfilled and the electric parking brake is not released automatically, release the electric parking brake manually (→ page 153).</li></ul> <p>If it is still not possible to release the electric parking brake:</p> <ul style="list-style-type: none"><li>► Do not continue driving. Consult a qualified specialist workshop.</li></ul>
 <p>(USA only)</p>  <p>(Canada only)</p> <p>Please Release Parking Brake</p>	<p>* The red  indicator lamp (USA only) or  indicator lamp (Canada only) is flashing.</p> <p>The electric parking brake is applied while you are driving:</p> <ul style="list-style-type: none"><li>• A condition for automatic release of the electric parking brake has not been fulfilled (→ page 152).</li><li>• You are performing emergency braking using the electric parking brake (→ page 153).</li></ul> <ul style="list-style-type: none"><li>► Check the conditions for automatic release of the electric parking brake.</li><li>► Release the electric parking brake manually.</li></ul>







Display messages	Possible causes/consequences and ► Solutions
<div data-bbox="205 249 362 332"></div> <div data-bbox="199 339 306 366">(USA only)</div> <div data-bbox="205 377 362 459"></div> <div data-bbox="199 467 338 494">(Canada only)</div> <div data-bbox="192 501 462 553">Turn On the Ignition to Release the Parking Brake</div>	<p>* The red  (USA only) or  (Canada only) indicator lamp is lit. You have attempted to release the electric parking brake with the vehicle switched off.</p> <ul style="list-style-type: none"> <li>► Switch on the vehicle.</li> </ul>
<div data-bbox="205 581 362 664"></div> <div data-bbox="192 671 301 698">(USA only)</div> <div data-bbox="205 708 362 791"></div> <div data-bbox="192 798 332 825">(Canada only)</div> <div data-bbox="192 832 439 853">Check Brake Fluid Level</div>	<p>* There is insufficient brake fluid in the brake fluid reservoir.</p> <div data-bbox="550 622 1696 660" style="background-color: #e0e0e0; padding: 5px;"> <p> <b>WARNING</b> Risk of an accident due to low brake fluid level</p> </div> <p>If the brake fluid level is too low, the braking effect and the braking characteristics may be impaired.</p> <ul style="list-style-type: none"> <li>► Pull over and stop the vehicle safely as soon as possible, paying attention to road and traffic conditions. Do not continue driving under any circumstances.</li> <li>► Consult a qualified specialist workshop.</li> <li>► Do not add brake fluid.</li> </ul>



## 424 Display messages and warning/indicator lamps

Display messages	Possible causes/consequences and ► Solutions
<a href="#">Check Brake Pads See Operator's Manual</a>	<ul style="list-style-type: none"><li>* The brakepads have reached the wear limit.<ul style="list-style-type: none"><li>► Consult a qualified specialist workshop.</li></ul></li></ul>

### Driving systems

Display messages	Possible causes/consequences and ► Solutions
 <p>Off</p>	<ul style="list-style-type: none"><li>* The HOLD function is deactivated because the vehicle is slipping or a condition for activation is not fulfilled.<ul style="list-style-type: none"><li>► Reactivate the HOLD function later or check the activation conditions for the HOLD function (→ page 159).</li></ul></li></ul>
 <p>ATTENTION ASSIST Inoperative</p>	<ul style="list-style-type: none"><li>* ATTENTION ASSIST is malfunctioning.<ul style="list-style-type: none"><li>► Visit a qualified specialist workshop.</li></ul></li></ul>

Display messages	Possible causes/consequences and ► Solutions
 <p data-bbox="195 342 473 389">ATTENTION ASSIST: Take a Break!</p>	<ul style="list-style-type: none"> <li>* ATTENTION ASSIST has detected fatigue or an increasing lack of concentration on the part of the driver (→ page 161).               <ul style="list-style-type: none"> <li>► If necessary, take a break.</li> </ul> </li> </ul>
 <p data-bbox="195 511 279 532">--- mph</p>	<ul style="list-style-type: none"> <li>* Cruise control cannot be activated as not all activation conditions are fulfilled.               <ul style="list-style-type: none"> <li>► Observe the activation conditions for cruise control (→ page 163).</li> </ul> </li> </ul>
<p data-bbox="195 557 463 581">Cruise Control Inoperative</p>	<ul style="list-style-type: none"> <li>* Cruise control is malfunctioning.               <ul style="list-style-type: none"> <li>► Visit a qualified specialist workshop.</li> </ul> </li> </ul>
<p data-bbox="195 632 380 656">Cruise Control Off</p>	<ul style="list-style-type: none"> <li>* Cruise control has been deactivated.               <p data-bbox="547 667 1544 691">If there is an additional warning tone, cruise control has been deactivated automatically (→ page 162).</p> </li> </ul>
 <p data-bbox="195 801 279 822">--- mph</p>	<ul style="list-style-type: none"> <li>* Active Distance Assist DISTRONIC cannot be activated as not all activation conditions are fulfilled.               <ul style="list-style-type: none"> <li>► Comply with the activation conditions of Active Distance Assist DISTRONIC (→ page 167).</li> </ul> </li> </ul>

Display messages	Possible causes/consequences and ► Solutions
 <p>Suspended</p>	<p>* If you depress the accelerator pedal beyond the setting of Active Distance Assist DISTRONIC, the system will switch to passive mode (→ page 164).</p>
 <p>Off</p>	<p>* Active Distance Assist DISTRONIC was deactivated. If a warning tone also sounds, Active Distance Assist DISTRONIC has deactivated automatically (→ page 167).</p>
<p>Active Distance Assist Currently Unavailable See Operator's Manual</p>	<p>* Active Distance Assist DISTRONIC is temporarily unavailable. The ambient conditions are outside the system limits (→ page 164). As soon as the ambient conditions are within the system limits, the system will become available again.</p> <ul style="list-style-type: none"> <li>► Drive on carefully.</li> <li>or</li> <li>► If the display message does not disappear, stop the vehicle in accordance with the traffic conditions and restart the vehicle.</li> </ul>
<p>Active Distance Assist Inoperative</p>	<p>* Active Distance Assist DISTRONIC is malfunctioning. Other driving systems and driving safety systems may also be malfunctioning.</p> <ul style="list-style-type: none"> <li>► Drive on carefully.</li> </ul>

Display messages	Possible causes/consequences and ► Solutions
	<p>or</p> <ul style="list-style-type: none"> <li>► Stop the vehicle in accordance with the traffic conditions and restart the vehicle.</li> <li>► If the display message does not disappear: consult a qualified specialist workshop.</li> </ul>
Active Distance Assist Now Available	<ul style="list-style-type: none"> <li>* Active Distance Assist DISTRONIC is operational again. <ul style="list-style-type: none"> <li>► Switch on Active Distance Assist DISTRONIC (→ page 167).</li> </ul> </li> </ul>
Active Steering Assist Currently Unavailable See Operator's Manual	<ul style="list-style-type: none"> <li>* Active Steering Assist is temporarily unavailable. The ambient conditions are outside the system limits (→ page 170). As soon as the ambient conditions are within the system limits, the system will become available again. <ul style="list-style-type: none"> <li>► Drive on</li> <li>► If necessary, clean the windshield in the camera's field of vision.</li> <li>► Check the tire pressure if necessary.</li> </ul> </li> </ul>
Active Steering Assist Inoperative	<ul style="list-style-type: none"> <li>* Active Steering Assist is malfunctioning. Active Distance Assist DISTRONIC remains available. <ul style="list-style-type: none"> <li>► Drive on</li> </ul> </li> </ul> <p>or</p> <ul style="list-style-type: none"> <li>► Stop the vehicle in accordance with the traffic conditions and restart the vehicle.</li> <li>► If the display message does not disappear: consult a qualified specialist workshop.</li> </ul>

Display messages	Possible causes/consequences and ► Solutions
<p>Active Steering Assist Currently Unavailable Due to Multiple Emergency Stops</p>	<p>* Active Steering Assist is temporarily unavailable due to multiple emergency stops.</p> <ul style="list-style-type: none"> <li>► Take over the steering and stop in accordance with the traffic conditions.</li> <li>► Switch the vehicle off and switch it back on. Active Steering Assist is available once more.</li> </ul>
<p>Beginning Emergency Stop</p>	<p>* Your hands are not on the steering wheel. An emergency stop is being initiated (→ page 173).</p> <ul style="list-style-type: none"> <li>► Put your hands back on the steering wheel.</li> </ul> <p>You can cancel the deceleration at any time by performing one of the following actions:</p> <ul style="list-style-type: none"> <li>• Steering</li> <li>• Braking or accelerating</li> <li>• Deactivating Active Distance Assist DISTRONIC</li> </ul>
	<p>* Active Steering Assist has reached the system limits (→ page 170). You have not steered independently for a considerable period of time.</p> <ul style="list-style-type: none"> <li>► Take over the steering and drive on in accordance with the traffic conditions.</li> </ul>
<p>Traffic Sign Assist Currently Unavailable See Operator's Manual</p>	<p>* Traffic Sign Assist is temporarily unavailable. Once the cause of the problem is no longer present, the system will be available again.</p> <ul style="list-style-type: none"> <li>► It is possible to continue driving in compliance with the traffic regulations.</li> <li>► If the display message does not disappear, stop the vehicle safely and clean the windshield.</li> </ul>

Display messages	Possible causes/consequences and ► Solutions
Traffic Sign Assist Inoperative	<p>* Traffic Sign Assist is malfunctioning.</p> <ul style="list-style-type: none"> <li>► It is possible to continue driving in compliance with the traffic regulations.</li> </ul> <p>or</p> <ul style="list-style-type: none"> <li>► Stop the vehicle in accordance with the traffic conditions and restart the vehicle.</li> <li>► If the display message does not disappear: consult a qualified specialist workshop.</li> </ul>
Traffic Sign Assist Camera View Restricted See Operator's Manual	<p>* The camera view is restricted. Possible causes:</p> <ul style="list-style-type: none"> <li>• Dirt on the windshield in the camera's field of vision</li> <li>• Heavy rain, snow or fog</li> </ul> <p>Driving systems and driving safety systems may be malfunctioning or temporarily unavailable.</p> <p>Once the cause of the problem is no longer present, the driving systems and driving safety systems will be available again.</p> <p>If the display message does not disappear:</p> <ul style="list-style-type: none"> <li>► Stop the vehicle in accordance with the traffic conditions.</li> <li>► Clean the windshield.</li> </ul>
Blind Spot Assist Currently Unavailable See Operator's Manual	<p>* Blind Spot Assist is temporarily unavailable.</p> <p>The system limits have been reached (→ page 181).</p> <p>Once the cause of the problem is no longer present, the system will be available again.</p> <ul style="list-style-type: none"> <li>► Drive on</li> </ul>





Display messages	Possible causes/consequences and ► Solutions
	<p>or</p> <ul style="list-style-type: none"> <li>► If the display message does not disappear, stop the vehicle in accordance with the traffic conditions and restart the vehicle.</li> <li>► If necessary, clean the rear bumper. If the bumper is especially dirty, the sensors in the bumper may be malfunctioning.</li> </ul>
<p>Blind Spot Assist Inoperative</p>	<p>* Blind Spot Assist is malfunctioning.</p> <ul style="list-style-type: none"> <li>► Drive on</li> </ul> <p>or</p> <ul style="list-style-type: none"> <li>► Stop the vehicle in accordance with the traffic conditions and restart the vehicle.</li> <li>► If the display message does not disappear: consult a qualified specialist workshop.</li> </ul>
<p>Active Blind Spot Assist Currently Unavailable See Operator's Manual</p>	<p>* Active Blind Spot Assist is temporarily unavailable. The system limits have been reached (→ page 181). Once the cause of the problem is no longer present, the system will be available again.</p> <ul style="list-style-type: none"> <li>► Drive on</li> </ul> <p>or</p> <ul style="list-style-type: none"> <li>► If the display message does not disappear, stop the vehicle in accordance with the traffic conditions and restart the vehicle.</li> </ul>
<p>Active Blind Spot Assist Inoperative</p>	<p>* Active Blind Spot Assist is malfunctioning.</p> <ul style="list-style-type: none"> <li>► Drive on</li> </ul>



Display messages	Possible causes/consequences and ► Solutions
	<p>or</p> <ul style="list-style-type: none"> <li>► Stop the vehicle in accordance with the traffic conditions and restart the vehicle.</li> <li>► If the display message does not disappear: consult a qualified specialist workshop.</li> </ul>
<p>Active Lane Keeping Assist Currently Unavailable See Operator's Manual</p>	<p>* Active Lane Keeping Assist is temporarily unavailable. The ambient conditions are outside the system limits (→ page 184). As soon as the ambient conditions are within the system limits, the system will become available again.</p> <p><b>Vehicles with Active Steering Assist:</b> The camera view may be limited by the windshield.</p> <ul style="list-style-type: none"> <li>► Drive on</li> </ul> <p><b>Vehicles with Active Steering Assist:</b> If the display message does not disappear:</p> <ul style="list-style-type: none"> <li>► Stop the vehicle in accordance with the traffic conditions.</li> <li>► Clean the windshield.</li> </ul>
<p>Active Lane Keeping Assist Inoperative</p>	<p>* Active Lane Keeping Assist is malfunctioning.</p> <ul style="list-style-type: none"> <li>► Drive on</li> </ul> <p>or</p> <ul style="list-style-type: none"> <li>► Stop the vehicle in accordance with the traffic conditions and restart the vehicle.</li> <li>► If the display message does not disappear: consult a qualified specialist workshop.</li> </ul>

Display messages	Possible causes/consequences and ► Solutions
<p>Active Lane Keeping Assist Camera View Restricted See Operator's Manual</p>	<p>* <b>Vehicles without Active Steering Assist:</b> the camera view is restricted.</p> <p>Possible causes:</p> <ul style="list-style-type: none"> <li>• Dirt on the windshield in the camera's field of vision</li> <li>• Heavy rain, snow or fog</li> </ul> <p>Driving systems and driving safety systems may be malfunctioning or temporarily unavailable.</p> <p>Once the cause of the problem is no longer present, the driving systems and driving safety systems will be available again.</p> <p>If the display message does not disappear:</p> <ul style="list-style-type: none"> <li>► Stop the vehicle in accordance with the traffic conditions.</li> <li>► Clean the windshield.</li> </ul>
<div data-bbox="155 598 312 681" style="border: 1px solid black; padding: 5px; text-align: center;">  </div> <p>Malfunction Drive at Max. 50 mph</p>	<p>* AIRMATIC is functioning only to a limited extent. The vehicle's handling characteristics may be affected.</p> <div data-bbox="500 640 1646 785" style="border: 1px solid gray; padding: 5px;"> <p><b>!</b> <b>NOTE</b> The tires on the front axle or the fenders could be damaged by large steering movements</p> <ul style="list-style-type: none"> <li>► Avoid large steering movements while driving and listen for scraping sounds.</li> <li>► If you hear scraping sounds, pull over and stop the vehicle in accordance with the traffic conditions, and set a higher vehicle level if possible.</li> </ul> </div> <ul style="list-style-type: none"> <li>► Drive in a manner appropriate for the current level, but do not exceed 50 mph (80 km/h).</li> <li>► Visit a qualified specialist workshop.</li> </ul>

Display messages	Possible causes/consequences and ► Solutions
	<p>* DYNAMIC BODY CONTROL is malfunctioning. The vehicle's handling characteristics may be affected.</p> <ul style="list-style-type: none"> <li>► Do not drive at speeds greater than 50 mph (80 km/h).</li> <li>► Visit a qualified specialist workshop.</li> </ul>
<div data-bbox="203 367 360 450" data-label="Image"> </div> <p data-bbox="194 455 452 507">Stop Vehicle Vehicle Too Low</p>	<p>* You have pulled away despite the vehicle level being too low.</p> <ul style="list-style-type: none"> <li>► Stop the vehicle in accordance with the traffic conditions. The vehicle will be raised to the selected vehicle level.</li> <li>► Wait until the display message disappears before pulling away.</li> </ul> <p>If the display message does not disappear and a warning tone also sounds, AIRMATIC is malfunctioning:</p> <ul style="list-style-type: none"> <li>► Do not drive at speeds greater than 50 mph (80 km/h) and consult a qualified specialist workshop immediately.</li> </ul> <div data-bbox="545 595 1690 740" data-label="Complex-Block" style="border: 1px solid black; padding: 5px;"> <p><b>!</b> <b>NOTE</b> The tires on the front axle or the fenders could be damaged by large steering movements</p> <ul style="list-style-type: none"> <li>► Avoid large steering movements while driving and listen for scraping sounds.</li> <li>► If you hear scraping sounds, pull over and stop the vehicle in accordance with the traffic conditions, and set a higher vehicle level if possible.</li> </ul> </div> <ul style="list-style-type: none"> <li>► Set a higher vehicle level (→ page 188). Depending on the malfunction, the vehicle will be raised.</li> </ul>



Display messages	Possible causes/consequences and ► Solutions
 Lowering	<ul style="list-style-type: none"><li>* The vehicle level will lower for the following reasons:<ul style="list-style-type: none"><li>• You have selected a different drive program.</li><li>• You have exceeded the speed limit.</li><li>• You have changed the vehicle level by pressing the button.</li></ul></li></ul>
 Vehicle Rising	<ul style="list-style-type: none"><li>* Your vehicle is adjusting to the level you have selected.</li></ul>
 Vehicle Rising Please Wait	<ul style="list-style-type: none"><li>* The vehicle level is too low. The vehicle will be raised to the selected vehicle level.<ul style="list-style-type: none"><li>► Wait until the display message disappears before pulling away.</li></ul></li></ul>
 Drive More Slowly	<ul style="list-style-type: none"><li>* You are driving too fast for the selected vehicle level.<ul style="list-style-type: none"><li>► To adjust the vehicle level, you must not drive at speeds greater than 37 mph (60 km/h).</li></ul></li></ul>

Display messages	Possible causes/consequences and ► Solutions
Parking Assist Maneuvering Assistance Restricted See Operator's Manual	<ul style="list-style-type: none"> <li>* The Parking Assist maneuvering assistant is temporarily unavailable or only partially available.               <ul style="list-style-type: none"> <li>► Clean all sensors of the parking and camera system (→ page 332).</li> <li>► If the display message still appears, consult a qualified specialist workshop.</li> </ul> </li> </ul>
Parking Assist and PARKTRONIC Inoperative See Operator's Manual	<ul style="list-style-type: none"> <li>* <b>Vehicles with Active Parking Assist:</b> Active Parking Assist and Parking Assist PARKTRONIC are malfunctioning. <b>Vehicles without Active Parking Assist:</b> Parking Assist PARKTRONIC is malfunctioning.               <ul style="list-style-type: none"> <li>► Stop the vehicle in accordance with the traffic conditions and restart the vehicle.</li> <li>► If the display message still appears, consult a qualified specialist workshop.</li> </ul> </li> </ul>

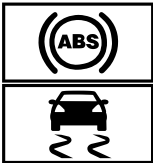
### Driving safety systems

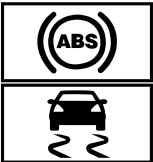
Display messages	Possible causes/consequences and ► Solutions
 <p>Currently Unavailable See Operator's Manual</p>	<ul style="list-style-type: none"> <li>* ABS and ESP<sup>®</sup> are temporarily unavailable. Other driving systems and driving safety systems (e.g. BAS) may also be temporarily unavailable. The brake system will continue to operate normally. Braking distance may increase in an emergency braking situation.</li> </ul> <div style="background-color: #f0f0f0; padding: 5px; margin-top: 10px;"> <p><b>⚠ WARNING</b> Risk of skidding if ABS and ESP<sup>®</sup> are malfunctioning</p> <p>The wheels may lock during braking and ESP<sup>®</sup> does not perform any vehicle stabilization.</p> </div>

Display messages	Possible causes/consequences and ► Solutions
	<p>The steerability and braking characteristics are heavily impaired and the braking distance may increase. In addition, other driving safety systems are switched off.</p> <ul style="list-style-type: none"> <li>► Drive carefully on a suitable stretch of road, making slight steering movements at a speed above 19 mph (30 km/h).</li> <li>► If the display message does not disappear, consult a qualified specialist workshop immediately. Drive carefully.</li> </ul>
 <p>Inoperative See Operator's Manual</p>	<p>* ABS and ESP® are malfunctioning. Other driving systems and driving safety systems (e.g. BAS) may also be malfunctioning. The brake system will continue to operate normally. Braking distance may increase in an emergency braking situation.</p> <p><b>▲ WARNING</b> Risk of skidding if ABS and ESP® are malfunctioning</p> <p>The wheels may block during braking and ESP® does not perform any vehicle stabilization. The steerability and braking characteristics are heavily impaired and the braking distance may increase. In addition, other driving safety systems are switched off.</p> <ul style="list-style-type: none"> <li>► Drive on carefully.</li> <li>► Have ABS and ESP® checked immediately at a qualified specialist workshop.</li> </ul>

Display messages	Possible causes/consequences and ► Solutions
 <p data-bbox="195 342 463 391">Currently Unavailable See Operator's Manual</p>	<p data-bbox="524 249 1400 311">* ESP® is temporarily unavailable. Other driving systems and driving safety systems (e.g. BAS) may also be malfunctioning.</p> <div data-bbox="550 329 1696 563" style="border: 1px solid gray; padding: 5px;"> <p data-bbox="559 339 1114 365"><b>▲ WARNING</b> Risk of skidding if ESP is malfunctioning®</p> <p data-bbox="559 381 1672 427">If ESP® is malfunctioning, ESP® cannot carry out vehicle stabilization. In addition, other driving safety systems are switched off.</p> <ul data-bbox="559 443 1635 553" style="list-style-type: none"> <li data-bbox="559 443 1617 490">▶ Drive carefully on a suitable stretch of road, making slight steering movements at a speed above 19 mph (30 km/h).</li> <li data-bbox="559 505 1635 553">▶ If the display message does not disappear, consult a qualified specialist workshop immediately. Drive carefully.</li> </ul> </div>
 <p data-bbox="195 674 463 723">Inoperative See Operator's Manual</p>	<p data-bbox="524 581 1690 674">* ESP® is malfunctioning. Other driving systems and driving safety systems (e.g. BAS) may also be malfunctioning. The brake system will continue to operate normally. Braking distance may increase in an emergency braking situation.</p> <div data-bbox="550 692 1696 874" style="border: 1px solid gray; padding: 5px;"> <p data-bbox="559 702 1114 728"><b>▲ WARNING</b> Risk of skidding if ESP® is malfunctioning</p> <p data-bbox="559 743 1672 790">If ESP® is malfunctioning, ESP® cannot carry out vehicle stabilization. In addition, other driving safety systems are switched off.</p> <ul data-bbox="559 806 1129 868" style="list-style-type: none"> <li data-bbox="559 806 778 831">▶ Drive on carefully.</li> <li data-bbox="559 842 1129 868">▶ Have ESP® checked at a qualified specialist workshop.</li> </ul> </div>

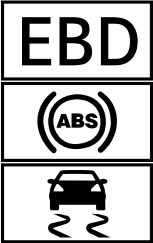
Display messages	Possible causes/consequences and ► Solutions
 <p data-bbox="144 511 417 560">Inoperative See Operator's Manual</p>	<p data-bbox="476 249 1350 311">* EBD, ABS and ESP® are malfunctioning. Other driving systems and driving safety systems (e.g. BAS) may also be malfunctioning.</p> <div data-bbox="500 327 1648 547" style="border: 1px solid gray; padding: 5px;"> <p data-bbox="506 337 1221 365"><b>▲ WARNING</b> Risk of skidding if EBD, ABS and ESP® are malfunctioning</p> <p data-bbox="506 381 1391 407">The wheels may block during braking and ESP® does not perform any vehicle stabilization.</p> <p data-bbox="506 415 1600 467">The steerability and braking characteristics are heavily impaired and the braking distance may increase. In addition, other driving safety systems are switched off.</p> <ul style="list-style-type: none"> <li data-bbox="506 477 722 503">► Drive on carefully.</li> <li data-bbox="506 511 1313 537">► Have the brake system checked immediately at a qualified specialist workshop.</li> </ul> </div>
<p data-bbox="144 586 421 660">Active Brake Assist Functions Currently Limited See Operator's Manual</p>	<p data-bbox="476 586 1648 638">* <b>Vehicles with the Driving Assistance Package:</b> Active Brake Assist with cross-traffic function, Evasive Steering Assist or PRE-SAFE® PLUS are temporarily unavailable or only partially available.</p> <p data-bbox="491 648 1421 674"><b>Vehicles without the Driving Assistance Package:</b> Active Brake Assist is temporarily unavailable.</p> <ul style="list-style-type: none"> <li data-bbox="491 684 1535 736">► Drive on carefully. As soon as the ambient conditions are within the system limits, the system will become available again.</li> <li data-bbox="491 746 519 767">or</li> <li data-bbox="491 778 1618 829">► If the display message does not disappear, stop the vehicle in accordance with the traffic conditions and restart the vehicle.</li> </ul>



Display messages	Possible causes/consequences and ► Solutions
<p>Active Brake Assist Functions Limited See Operator's Manual</p>	<p>* For vehicles with the Driving Assistance Package, the following functions may be temporarily unavailable or only partially available:</p> <ul style="list-style-type: none"> <li>• Active Brake Assist with cross-traffic function</li> <li>• Evasive Steering Assist</li> <li>• PRE-SAFE® PLUS</li> </ul> <p><b>Vehicles without the Driving Assistance Package:</b> Active Brake Assist is temporarily unavailable or only partially available.</p> <p>► Drive on carefully.</p> <p>or</p> <p>► Stop the vehicle in accordance with the traffic conditions and restart the vehicle.</p> <p>► If the display message does not disappear: consult a qualified specialist workshop.</p>
<p>Radar Sensors Dirty See Operator's Manual</p>	<p>* The radar sensor system is malfunctioning. Possible causes:</p> <ul style="list-style-type: none"> <li>• Dirt on the sensors</li> <li>• Heavy rain or snow</li> <li>• Extended country driving without other traffic, e.g. in the desert</li> </ul> <p>Driving systems and driving safety systems may be malfunctioning or temporarily unavailable.</p> <p>Once the cause of the problem is no longer present, the driving systems and driving safety systems will be available again.</p> <p>If the display message does not disappear:</p>

#### 440 Display messages and warning/indicator lamps

Display messages	Possible causes/consequences and ► Solutions
	<ul style="list-style-type: none"><li>► Stop the vehicle in accordance with the traffic conditions.</li><li>► Clean all sensors (→ page 332).</li><li>► Restart the vehicle.</li></ul>

#### Mercedes-Benz emergency call system

Display messages	Possible causes/consequences and ► Solutions
 Inoperative	<p>* The Mercedes-Benz emergency call system is malfunctioning. The Mercedes me connect system is also malfunctioning.</p> <ul style="list-style-type: none"><li>► Consult a qualified specialist workshop.</li></ul>
Mercedes me connect Services Limited See Operator's Manual	<p>* The vehicle functions for malfunction detection are restricted.</p> <p>At least one of the main functions of the Mercedes me connect system is malfunctioning.</p> <ul style="list-style-type: none"><li>► Observe the notes on the diagnostics connection (→ page 26).</li><li>► Consult a qualified specialist workshop.</li></ul>

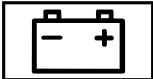
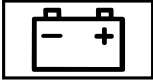

## Battery

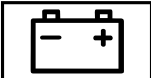
Display messages	Possible causes/consequences and ► Solutions
 <p data-bbox="195 381 445 430">12 V Battery See Operator's Manual</p>	<ul style="list-style-type: none"> <li data-bbox="524 291 1276 313">* The vehicle is off and the condition of charge of the 12 V battery is too low.               <ul style="list-style-type: none"> <li data-bbox="543 324 1101 347">► Switch off electrical consumers that are not required.</li> <li data-bbox="543 353 796 376">► Drive for 30–60 mins.</li> </ul> </li> <li data-bbox="543 386 569 409">or</li> <li data-bbox="543 419 1129 442">► Charge the 12 V battery when stationary (→ page 347).</li> </ul> <ul style="list-style-type: none"> <li data-bbox="524 452 1646 475">* If the message appears while the vehicle is switched on, this indicates an on-board electrical system malfunction.               <ul style="list-style-type: none"> <li data-bbox="543 485 935 508">► Visit a qualified specialist workshop.</li> </ul> </li> </ul>
 <p data-bbox="195 622 426 645">See Operator's Manual</p>	<ul style="list-style-type: none"> <li data-bbox="524 532 920 555">* The 12 V battery is not being charged.               <div data-bbox="547 570 1696 692" style="border: 1px solid gray; padding: 5px; margin-top: 5px;"> <p data-bbox="556 581 1123 603"><b>!</b> <b>NOTE</b> Possible engine damage if you continue driving</p> <ul style="list-style-type: none"> <li data-bbox="556 622 1082 645">► Do not continue driving under any circumstances.</li> <li data-bbox="556 655 981 678">► Consult a qualified specialist workshop.</li> </ul> </div> <ul style="list-style-type: none"> <li data-bbox="543 707 1406 730">► Stop immediately in accordance with the traffic conditions and switch off the vehicle.</li> <li data-bbox="543 740 962 763">► Consult a qualified specialist workshop.</li> </ul> </li> </ul>

Display messages	Possible causes/consequences and ► Solutions
 <p data-bbox="144 342 391 389">Stop Vehicle See Operator's Manual</p>	<p data-bbox="476 249 1258 275">* The 12 V battery is no longer being charged and the state of charge is too low.</p> <div data-bbox="500 291 1646 412" style="border: 1px solid black; padding: 5px;"> <p data-bbox="510 301 1073 327"><b>!</b> <b>NOTE</b> Possible engine damage if you continue driving</p> <ul style="list-style-type: none"> <li data-bbox="510 342 1031 368">► Do not continue driving under any circumstances.</li> <li data-bbox="510 373 935 399">► Consult a qualified specialist workshop.</li> </ul> </div> <ul style="list-style-type: none"> <li data-bbox="495 425 1609 477">► Pull over and stop the vehicle safely as soon as possible, paying attention to road and traffic conditions. Do not continue driving.</li> <li data-bbox="495 487 746 513">► Switch off the vehicle.</li> <li data-bbox="495 519 916 544">► Consult a qualified specialist workshop.</li> </ul>
 <p data-bbox="144 656 413 708">Stop Vehicle Leave Engine Running</p>	<p data-bbox="476 563 957 589">* The 12 V battery condition of charge is too low.</p> <ul style="list-style-type: none"> <li data-bbox="495 594 1609 646">► Pull over and stop the vehicle safely as soon as possible, paying attention to road and traffic conditions. Do not continue driving.</li> <li data-bbox="495 656 783 682">► Leave the engine running.</li> <li data-bbox="495 687 957 713">► If the display message disappears: drive on.</li> <li data-bbox="495 718 1332 750">► If the display message does not disappear: consult a qualified specialist workshop.</li> </ul>

## Tire pressure monitor

Display messages	Possible causes/consequences and ► Solutions
Tire Press. Monitor Currently Unavailable	<ul style="list-style-type: none"> <li>* There is interference from a powerful radio signal source. As a result, no signals from the tire pressure sensors are being received. The tire pressure monitoring system is temporarily unavailable. The tire pressure monitoring system will restart automatically as soon as the cause has been rectified.               <ul style="list-style-type: none"> <li>► Drive on.</li> </ul> </li> </ul>
Tire Press. Monitor Inoperative	<ul style="list-style-type: none"> <li>* The tire pressure monitoring system is malfunctioning.               <div style="border: 1px solid gray; padding: 5px; margin-top: 10px;"> <p><b>⚠ WARNING</b> There is a risk of an accident if the tire pressure monitoring system is malfunctioning</p> <p>The tire pressure monitoring system cannot issue a warning if there is pressure loss in one or more of the tires. Tires with insufficient tire pressure may impair the driving characteristics as well as steering and braking.</p> <p>► Have the tire pressure monitoring system checked at a qualified specialist workshop.</p> </div> </li> </ul>
Tire Pressure Monitor Inoperative No Wheel Sensors	<ul style="list-style-type: none"> <li>* The wheels installed do not have suitable tire pressure sensors. The tire pressure monitoring system is deactivated.               <ul style="list-style-type: none"> <li>► Install wheels with suitable tire pressure sensors.</li> </ul> </li> </ul>
 Wheel Sensor(s) Missing	<ul style="list-style-type: none"> <li>* There is no signal from the tire pressure sensor of one or more wheels. No pressure value is displayed for the affected tire.               <ul style="list-style-type: none"> <li>► Have the faulty tire pressure sensor replaced at a qualified specialist workshop.</li> </ul> </li> </ul>

Display messages	Possible causes/consequences and ► Solutions
 <p data-bbox="144 339 266 364">Check Tires</p>	<p data-bbox="476 249 1110 308">* The tire pressure in one or more tires has dropped significantly. The wheel position is displayed. A warning tone will also sound.</p> <div data-bbox="500 325 1646 588" style="border: 1px solid gray; padding: 5px;"> <p data-bbox="506 335 1156 360">▲ <b>WARNING</b> Risk of an accident due to insufficient tire pressure</p> <ul data-bbox="519 373 1393 467" style="list-style-type: none"> <li>• The tires can burst.</li> <li>• The tires can wear excessively and/or unevenly.</li> <li>• The driving characteristics as well as the steering and braking may be greatly impaired.</li> </ul> <p data-bbox="513 484 920 508">You could then lose control of the vehicle.</p> <ul data-bbox="513 522 962 578" style="list-style-type: none"> <li>► Observe the recommended tire pressures.</li> <li>► Adjust the tire pressure if necessary.</li> </ul> </div> <ul data-bbox="495 605 1092 664" style="list-style-type: none"> <li>► Stop the vehicle in accordance with the traffic conditions.</li> <li>► Check the tire pressure (→ page 358) and the tires.</li> </ul>
 <p data-bbox="144 771 395 826">Please Correct Tire Pressure</p>	<p data-bbox="476 681 1637 733">* The tire pressure is too low in at least one of the tires, or the difference in tire pressure between the individual wheels is too great.</p> <ul data-bbox="495 743 1326 801" style="list-style-type: none"> <li>► Check the tire pressure and add air, if necessary.</li> <li>► When the tire pressure is correct, restart the tire pressure monitor (→ page 363).</li> </ul>

Display messages	Possible causes/consequences and ► Solutions
 <p data-bbox="194 341 452 367">Warning Tire Malfunction</p>	<p data-bbox="526 248 1496 274">* The tire pressure in one or more tires has dropped suddenly. The wheel position will be displayed.</p> <div data-bbox="545 290 1690 336" style="background-color: #f0f0f0; padding: 5px;"> <p data-bbox="554 295 1164 326"><b>▲ WARNING</b> Risk of an accident from driving with a flat tire</p> <ul data-bbox="563 336 1598 398" style="list-style-type: none"> <li data-bbox="563 336 988 367">• The tires can overheat and be damaged.</li> <li data-bbox="563 367 1598 398">• The driving characteristics as well as the steering and braking characteristics may be greatly impaired.</li> </ul> <p data-bbox="554 414 970 440">You could then lose control of the vehicle.</p> <ul data-bbox="563 450 1653 574" style="list-style-type: none"> <li data-bbox="563 450 859 476">► Do not drive with a flat tire.</li> <li data-bbox="563 481 1653 533">► Do not exceed the maximum permissible driving distance in emergency mode and the maximum permissible speed with a flat MOExtended tire.</li> <li data-bbox="563 538 896 569">► Observe the notes on flat tires.</li> </ul> </div> <p data-bbox="545 595 997 621">Notes in the event of a flat tire (→ page 337).</p> <ul data-bbox="545 631 1145 694" style="list-style-type: none"> <li data-bbox="545 631 1145 657">► Stop the vehicle in accordance with the traffic conditions.</li> <li data-bbox="545 663 739 694">► Check the tires.</li> </ul>
<p data-bbox="194 709 369 735">Tires Overheated</p>	<p data-bbox="526 709 1663 761">* At least one tire is overheating. The affected tires are displayed in red. At temperatures close to the limit value, the tires are displayed in yellow.</p> <div data-bbox="545 777 1690 823" style="background-color: #f0f0f0; padding: 5px;"> <p data-bbox="554 782 1228 813"><b>▲ WARNING</b> Risk of an accident from driving with overheated tires</p> <p data-bbox="554 823 831 849">Overheated tires can burst.</p> </div>

## 446 Display messages and warning/indicator lamps

Display messages	Possible causes/consequences and ► Solutions
	<p>► Reduce speed so that the tires cool down.</p>
Decrease Speed	<p>* At least one tire is overheating. The affected tires are displayed in red. At temperatures close to the limit value, the tires are displayed in yellow.</p> <p><b>▲ WARNING</b> Risk of an accident from driving with overheated tires</p> <p>Overheated tires can burst.</p> <p>► Reduce speed so that the tires cool down.</p>



### Tire pressure loss warning system



Display messages	Possible causes/consequences and ► Solutions
Check Tire Pressure Soon	<p>* Canada only: The tire pressure loss warning system has detected a significant loss of pressure.</p> <p><b>▲ WARNING</b> Risk of an accident due to insufficient tire pressure</p> <ul style="list-style-type: none"><li>• The tires can burst.</li><li>• The tires can wear excessively and/or unevenly.</li><li>• The driving characteristics as well as the steering and braking may be greatly impaired.</li></ul>





Display messages	Possible causes/consequences and ► Solutions
	<p>You could then lose control of the vehicle.</p> <ul style="list-style-type: none"> <li>► Observe the recommended tire pressures.</li> <li>► Adjust the tire pressure if necessary.</li> </ul> <ul style="list-style-type: none"> <li>► Stop the vehicle in accordance with the traffic conditions.</li> <li>► Check the tire pressure (→ page 358) and the tires.</li> <li>► When the tire pressure is correct, restart the tire pressure loss warning system (→ page 363).</li> </ul>
<p>Check Tire Pressure Then Restart Run Flat Indicator</p>	<p>* Canada only: The tire pressure loss warning system generated a display message and has not been restarted since.</p> <ul style="list-style-type: none"> <li>► When the tire pressure is correct, restart the tire pressure loss warning system (→ page 363).</li> </ul>
<p>Run Flat Indicator Inoperative</p>	<p>* Canada only: The tire pressure loss warning system is malfunctioning.</p> <ul style="list-style-type: none"> <li>► Consult a qualified specialist workshop.</li> </ul>

## Engine oil

Display messages	Possible causes/consequences and ► Solutions
 <p data-bbox="144 381 402 433">Check Engine Oil At Next Refueling</p>	<p data-bbox="476 288 1023 313">* The engine oil level has dropped to the minimum level.</p> <div data-bbox="500 332 1646 370" style="border: 1px solid gray; padding: 2px;"> <p data-bbox="506 339 1201 365">! <b>NOTE</b> Engine damage caused by driving with insufficient engine oil</p> </div> <div data-bbox="500 373 1646 415" style="border: 1px solid gray; padding: 2px;"> <p data-bbox="506 381 1005 407">► Avoid long journeys with insufficient engine oil.</p> </div> <p data-bbox="491 433 984 458">► Check the engine oil level when next refueling.</p> <p data-bbox="491 474 787 500">Add engine oil (→ page 325).</p> <p data-bbox="491 510 837 536">Notes on engine oil (→ page 394).</p>
 <p data-bbox="144 646 376 698">Check Engine Oil Level (Add 1 quart)</p>	<p data-bbox="476 553 1023 610">* Display message only for certain engines: The engine oil level has dropped to the minimum level.</p> <div data-bbox="500 628 1646 667" style="border: 1px solid gray; padding: 2px;"> <p data-bbox="506 636 1201 662">! <b>NOTE</b> Engine damage caused by driving with insufficient engine oil</p> </div> <div data-bbox="500 670 1646 711" style="border: 1px solid gray; padding: 2px;"> <p data-bbox="506 677 1005 703">► Avoid long journeys with insufficient engine oil.</p> </div> <p data-bbox="491 729 1193 755">► When next refueling, add 1.1 US qt (1 l) of engine oil (→ page 325).</p> <p data-bbox="491 770 837 796">Notes on engine oil (→ page 394).</p>

Display messages	Possible causes/consequences and ► Solutions
 <p data-bbox="195 339 473 363">Engine Oil Reduce Oil Level</p>	<p data-bbox="524 249 949 308">* Display message only for certain engines: The engine oil level is too high.</p> <div data-bbox="550 325 1696 412" style="border: 1px solid black; padding: 5px;"> <p data-bbox="559 335 1208 360">! <b>NOTE</b> Engine damage caused by driving with excess engine oil</p> <p data-bbox="559 377 1012 401">► Avoid long journeys with excess engine oil.</p> </div> <p data-bbox="543 428 1456 453">► Consult a qualified specialist workshop immediately and have the engine oil level reduced.</p>
 <p data-bbox="195 560 458 612">Engine Oil Level Low Stop Vehicle Turn Engine Off</p>	<p data-bbox="524 470 949 529">* Display message only for certain engines: The engine oil level is too low.</p> <div data-bbox="550 545 1696 632" style="border: 1px solid black; padding: 5px;"> <p data-bbox="559 556 1249 581">! <b>NOTE</b> Engine damage caused by driving with insufficient engine oil</p> <p data-bbox="559 597 1055 622">► Avoid long journeys with insufficient engine oil.</p> </div> <p data-bbox="543 649 1504 674">► Stop the vehicle immediately in accordance with the traffic conditions. Do not continue driving.</p> <p data-bbox="543 680 796 705">► Switch off the vehicle.</p> <p data-bbox="543 711 1036 736">► Add 1.1 US qt (1 l) of engine oil (→ page 325).</p> <p data-bbox="543 742 833 767">► Check the engine oil level.</p> <p data-bbox="543 794 883 819">Notes on engine oil (→ page 394).</p>

Display messages	Possible causes/consequences and ► Solutions
 <p data-bbox="144 339 395 391">Engine Oil Pressure Stop Switch Off Engine</p>	<p data-bbox="473 249 901 308">* Display message only for certain engines: The oil pressure is too low.</p> <div data-bbox="500 325 1648 412" style="border: 1px solid black; padding: 5px;"> <p data-bbox="510 335 1221 360"><b>!</b> <b>NOTE</b> Engine damage caused by driving with insufficient oil pressure</p> <p data-bbox="510 373 957 398">► Avoid driving with insufficient oil pressure.</p> </div> <ul data-bbox="495 428 1456 519" style="list-style-type: none"> <li data-bbox="495 428 1456 456">► Stop the vehicle immediately in accordance with the traffic conditions. Do not continue driving.</li> <li data-bbox="495 459 746 487">► Switch off the vehicle.</li> <li data-bbox="495 491 916 519">► Consult a qualified specialist workshop.</li> </ul>
 <p data-bbox="144 626 417 678">Engine Oil Level Cannot Be Measured</p>	<p data-bbox="473 536 1461 561">* The electrical connection to the oil level sensor has been interrupted or the oil level sensor is faulty.</p> <ul data-bbox="495 570 916 595" style="list-style-type: none"> <li data-bbox="495 570 916 595">► Consult a qualified specialist workshop.</li> </ul>

### Warning and indicator lamps

#### Overview of indicator and warning lamps

Some systems will perform a self-test when the vehicle is switched on. Some indicator and warn-

ing lamps may briefly light up or flash. This behavior is non-critical. These indicator and warning lamps indicate a malfunction only if they light up or flash after the vehicle has been started or during a journey.

### Standard instrument display

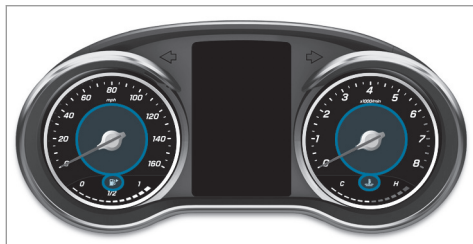



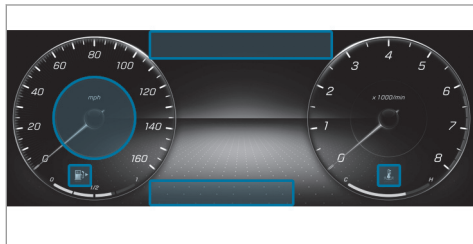





















### Widescreen cockpit instrument display



Depending on the display setting, the positions of the indicator lamps on the instrument display may differ from the example shown.

#### Indicator and warning lamps:

-  Restraint system (→ page 452)
-  Seat belt (→ page 452)
-  Power steering (→ page 453)
-  Coolant temperature (→ page 454)
-  Engine diagnostics (→ page 454)
-  Electrical malfunction (→ page 454)
-  Reserve fuel with fuel filler flap location indicator (→ page 454)
-  Electric parking brake (yellow) (→ page 458)
- PARK** USA: electric parking brake (red) (→ page 458)
-  Canada: electric parking brake (red) (→ page 458)
- RBS** USA: Recuperative Brake System (→ page 458)

-  Canada: brakes (yellow) (→ page 458)
- BRAKE** USA: brakes (red) (→ page 458)
-  Canada: brakes (red) (→ page 458)
-  Distance warning (→ page 461)
-  Active Brake Assist (→ page 461)
-  Active Brake Assist (→ page 461)
-  AIRMATIC (→ page 461)
-  DYNAMIC BODY CONTROL (→ page 461)
-  ABS (→ page 462)
-  ESP® (→ page 462)
-  ESP® OFF (→ page 462)
-  Tire pressure monitoring system (→ page 464)
-  Standing lights (→ page 112)
-  Low beam (→ page 112)
-  High beam (→ page 113)
-  Turn signal lights (→ page 113)
-  Rear fog light (→ page 112)



## 452 Display messages and warning/indicator lamps

### Symbols on the central display:

 Drive Away Assist (→ page 202)

 Cross Traffic Alert (→ page 203)

### Occupant safety

Warning/indicator lamp	Possible causes/consequences and ► Solutions
 <p data-bbox="144 505 395 553">Restraint system warning lamp</p>	<p data-bbox="463 412 1123 459">* The restraint system red warning lamp is lit while the vehicle is on. The restraint system is malfunctioning (→ page 37).</p> <div data-bbox="482 480 1652 598" style="border: 1px solid gray; padding: 5px;"><p data-bbox="491 491 1193 515"><b>▲ WARNING</b> Risk of injury due to malfunctions in the restraint system</p><p data-bbox="491 526 1559 551">Components in the restraint system may be activated unintentionally or not deploy as planned in an accident.</p><p data-bbox="491 561 1456 586">► Have the restraint system checked and repaired immediately at a qualified specialist workshop.</p></div> <ul data-bbox="476 615 1020 708" style="list-style-type: none"><li data-bbox="476 615 691 640">► Drive on carefully.</li><li data-bbox="476 650 957 675">► Note the messages on the instrument display.</li><li data-bbox="476 685 1020 710">► Consult a qualified specialist workshop immediately.</li></ul>
 <p data-bbox="144 819 373 844">Seat belt warning lamp</p>	<p data-bbox="463 726 1260 751">* The red seat belt warning lamp flashes and an intermittent warning tone sounds.</p> <p data-bbox="476 761 502 786">or</p> <p data-bbox="476 796 1308 821">The red seat belt warning lamp lights up for six seconds once the vehicle has started.</p> <p data-bbox="476 831 986 856">In addition, an intermittent warning tone may sound.</p> <p data-bbox="476 867 1260 891"><b>The red seat belt warning lamp flashes and an intermittent warning tone sounds:</b></p>

Warning/indicator lamp	Possible causes/consequences and ► Solutions
	<p>The driver or front passenger has not fastened his/her seat belt while the vehicle is in motion.</p> <ul style="list-style-type: none"> <li>► Fasten your seat belt (→ page 41).</li> </ul> <p>There are objects on the front passenger seat.</p> <ul style="list-style-type: none"> <li>► Remove the objects from the front passenger seat.</li> </ul> <p><b>The red seat belt warning lamp lights up once the vehicle has started:</b></p> <p>In addition, an intermittent warning tone may sound.</p> <p>The red seat belt warning lamp reminds the driver and front passenger to fasten their seat belts.</p> <ul style="list-style-type: none"> <li>► Fasten your seat belt (→ page 41).</li> </ul> <p>If you have placed objects on the front passenger seat, the red seat belt warning lamp may remain lit.</p>

## Vehicle

Warning/indicator lamp	Possible causes/consequences and ► Solutions
 <p>Power steering warning lamp (red)</p>	<p>* The red power steering warning lamp is lit while the vehicle is running. The power assistance or the steering itself is malfunctioning.</p> <p><b>⚠ WARNING</b> Risk of accident if steering capability is impaired</p> <p>If the steering does not function as intended, the vehicle's operating safety is jeopardized.</p>

## 454 Display messages and warning/indicator lamps



Warning/indicator lamp	Possible causes/consequences and ► Solutions
	<ul style="list-style-type: none"><li>▶ Pull over and stop the vehicle safely as soon as possible, paying attention to road and traffic conditions. Do not continue driving under any circumstances.</li><li>▶ Consult a qualified specialist workshop.</li></ul> <p>▶ Note the messages on the instrument display.</p>

## Engine

Warning/indicator lamp	Possible causes/consequences and ► Solutions
 <p>Coolant warning lamp</p>	<p>* The red coolant warning lamp is lit while the engine is running.</p> <p>Possible causes:</p> <ul style="list-style-type: none"><li>• The temperature sensor is malfunctioning</li><li>• The coolant level is too low</li><li>• The air supply to the radiator is obstructed</li><li>• The radiator fan is faulty</li><li>• The coolant pump is faulty</li></ul> <p>If there is an additional warning tone, the coolant temperature has exceeded the maximum permissible temperature.</p>









Warning/indicator lamp	Possible causes/consequences and ► Solutions
	<p data-bbox="535 253 1690 290"><b>▲ WARNING</b> Risk of burns when opening the hood</p> <p data-bbox="535 295 1690 347">If you open the hood in the event of an overheated engine or fire in the engine compartment, the following situations may occur:</p> <ul data-bbox="535 352 1690 419" style="list-style-type: none"><li data-bbox="535 352 1690 383">• You may come into contact with hot gases.</li><li data-bbox="535 388 1690 419">• You may come into contact with other escaping hot operating fluids.</li></ul> <p data-bbox="535 429 1690 461">► Before opening the hood, allow the engine to cool down.</p> <p data-bbox="535 466 1690 497">► In the event of a fire in the engine compartment, keep the hood closed and call the fire service.</p> <p data-bbox="535 518 1690 549">► Stop immediately in accordance with the traffic conditions and switch off the vehicle. Do not continue driving.</p> <p data-bbox="535 554 1690 585">► Note the messages on the instrument display.</p> <p data-bbox="535 600 1690 631"><b>If the coolant temperature display is at the lower end of the temperature scale:</b></p> <p data-bbox="535 637 1690 668">► Consult a qualified specialist workshop.</p> <p data-bbox="535 683 1690 714"><b>If the coolant temperature display is at the upper end of the temperature scale:</b></p> <ul data-bbox="535 720 1690 844" style="list-style-type: none"><li data-bbox="535 720 1690 751">► Exit the vehicle and keep a safe distance from it until the engine has cooled down.</li><li data-bbox="535 756 1690 787">► Check the coolant level (→ page 327).</li><li data-bbox="535 792 1690 823">► Make sure that the air supply to the radiator is not obstructed.</li><li data-bbox="535 828 1690 859">► Consult a qualified specialist workshop.</li></ul>

Warning/indicator lamp	Possible causes/consequences and ► Solutions
	<ul style="list-style-type: none"> <li>► Avoiding high loads on the engine, drive to the nearest qualified specialist workshop. In doing so, ensure that the coolant temperature display remains below the red area.</li> </ul>
 <p>Engine diagnosis warning lamp</p>	<ul style="list-style-type: none"> <li>* The yellow Check Engine warning lamp is lit while the engine is running. A malfunction has occurred in the engine, the exhaust system or the fuel system. The emission limit values may be exceeded and the engine may be in emergency mode. In some states, legal requirements stipulate that you must immediately consult a qualified specialist workshop as soon as the yellow Check Engine warning lamp lights up.               <ul style="list-style-type: none"> <li>► Have the vehicle checked as soon as possible at a qualified specialist workshop.</li> </ul> </li> </ul>
 <p>Electrical malfunction warning lamp</p>	<ul style="list-style-type: none"> <li>* The red electrical malfunction warning lamp is lit. There is a malfunction in the electrics.               <ul style="list-style-type: none"> <li>► Note the messages on the instrument display.</li> </ul> </li> </ul>
 <p>Fuel reserve warning lamp</p>	<ul style="list-style-type: none"> <li>* The yellow fuel reserve warning lamp lights up while you are driving.               <p><b>or</b></p> <p>The yellow fuel reserve warning lamp lights up while the engine is running.</p> <p><b>The yellow fuel reserve warning lamp lights up while you are driving:</b></p> <p>There has been pressure loss in the fuel system. The fuel filler cap is not closed correctly or the fuel system is leaking.</p> <ul style="list-style-type: none"> <li>► Close the fuel filler cap.</li> </ul> </li> </ul>

Warning/indicator lamp	Possible causes/consequences and ► Solutions
	<p>If the fuel filler cap has already been closed correctly:</p> <ul style="list-style-type: none"><li>► Consult a qualified specialist workshop.</li></ul> <p><b>The yellow fuel reserve warning lamp lights up while the engine is running:</b></p> <p>The fuel supply has dropped into the reserve range.</p> <ul style="list-style-type: none"><li>► Refuel.</li></ul>



## Brakes

Warning/indicator lamp	Possible causes/consequences and ► Solutions
 <p>Electric parking brake indicator lamp (red) (USA only)</p>  <p>Electric parking brake indicator lamp (red) (Canada only)</p>  <p>The electric parking brake (yellow) indicator lamp</p>	<p>* The red electric parking brake indicator lamp flashes or is lit. The yellow electric parking brake indicator lamp is also lit in the event of a malfunction.</p> <ul style="list-style-type: none"><li>► Note the messages on the instrument display.</li></ul>



Warning/indicator lamp	Possible causes/consequences and ► Solutions
 <p>Recuperative Brake System warning lamp (USA only)</p>  <p>Brakes warning lamp (yellow) (Canada only)</p>	<p>*The yellow  warning lamp (USA only) or the yellow  brake warning lamp (Canada only) is lit while the vehicle is running.</p> <p><b>▲ WARNING</b> Risk of an accident due to a brake system malfunction</p> <p>If the brake system is malfunctioning, braking characteristics may be impaired.</p> <ul style="list-style-type: none"><li>▶ Drive on carefully.</li><li>▶ Have the brake system checked immediately at a qualified specialist workshop.</li></ul> <p>► Adjust your speed and drive on carefully, leaving a suitable distance to the vehicle in front.</p> <p>► If the instrument display shows a display message, observe it.</p> <p>► Consult a qualified specialist workshop.</p>

Warning/indicator lamp	Possible causes/consequences and ► Solutions
<div data-bbox="155 252 312 332" data-label="Image"> </div> <p data-bbox="144 342 395 391">Brake warning lamp (USA only)</p> <div data-bbox="155 397 312 477" data-label="Image"> </div> <p data-bbox="144 487 413 536">Brake system warning lamp (Canada only)</p>	<p data-bbox="458 249 1068 273">* The red brake warning lamp is lit while the vehicle is running.</p> <p data-bbox="476 283 639 307">Possible causes:</p> <ul data-bbox="482 318 1400 377" style="list-style-type: none"> <li data-bbox="482 318 1400 341">• The brake force boosting is malfunctioning and the braking characteristics may be affected.</li> <li data-bbox="482 350 1073 373">• There is insufficient brake fluid in the brake fluid reservoir.</li> </ul> <p data-bbox="476 391 957 415">► Note the messages on the instrument display.</p> <div data-bbox="482 439 1646 477" data-label="Section-Header"> <p><b>▲ WARNING</b> Risk of accident and injury if brake force boosting is malfunctioning</p> </div> <p data-bbox="495 484 1591 533">If brake force boosting is malfunctioning, increased brake pedal force may be necessary for braking. The braking characteristics may be impaired. The braking distance can increase in emergency braking situations.</p> <ul data-bbox="495 543 1116 602" style="list-style-type: none"> <li data-bbox="495 543 1116 567">► Stop in a safe location immediately. Do not continue driving.</li> <li data-bbox="495 576 916 599">► Consult a qualified specialist workshop.</li> </ul> <div data-bbox="482 632 1646 671" data-label="Section-Header"> <p><b>▲ WARNING</b> Risk of an accident due to low brake fluid level</p> </div> <p data-bbox="495 678 1467 702">If the brake fluid level is too low, the braking effect and the braking characteristics may be impaired.</p> <ul data-bbox="495 712 1609 832" style="list-style-type: none"> <li data-bbox="495 712 1609 761">► Pull over and stop the vehicle safely as soon as possible, paying attention to road and traffic conditions. Do not continue driving under any circumstances.</li> <li data-bbox="495 769 916 793">► Consult a qualified specialist workshop.</li> <li data-bbox="495 801 753 825">► Do not add brake fluid.</li> </ul>

## Driving systems

Warning/indicator lamp	Possible causes/consequences and ► Solutions
 <p data-bbox="195 384 454 433">Warning lamp for distance warning function</p>	<p data-bbox="513 291 1212 339">* The red distance warning lamp lights up while the vehicle is in motion. The distance to the vehicle in front is too small for the speed selected.</p> <p data-bbox="528 353 1411 373">If there is an additional warning tone, you are approaching an obstacle at too high a speed.</p> <ul style="list-style-type: none"> <li data-bbox="528 387 898 408">► Be prepared to brake immediately.</li> <li data-bbox="528 421 781 442">► Increase the distance.</li> </ul> <p data-bbox="528 463 981 483">Function of Active Brake Assist (→ page 175).</p>
 <p data-bbox="195 598 445 647">Suspension warning lamp (yellow)</p>	<p data-bbox="513 505 925 526">* The yellow AIRMATIC warning lamp is lit.</p> <p data-bbox="528 539 1088 588">The yellow DYNAMIC BODY CONTROL warning lamp is lit. A malfunction has occurred in AIRMATIC.</p> <p data-bbox="528 601 1134 622">A malfunction has occurred in the DYNAMIC BODY CONTROL.</p> <ul style="list-style-type: none"> <li data-bbox="528 636 1009 656">► Note the messages on the instrument display.</li> </ul>

## Driving safety systems

Warning/indicator lamp	Possible causes/consequences and ► Solutions
 <p data-bbox="144 381 323 405">ABS warning lamp</p>	<p data-bbox="463 288 1082 339">* The yellow ABS warning lamp is lit while the vehicle is running. ABS is malfunctioning.</p> <p data-bbox="476 350 1060 373">If an additional warning tone sounds, EBD is malfunctioning.</p> <p data-bbox="476 384 1230 408">Other driving systems and driving safety systems may also be malfunctioning.</p> <p data-bbox="476 418 959 442">► Note the messages on the instrument display.</p> <div data-bbox="482 464 1646 671" style="border: 1px solid black; padding: 5px;"> <p data-bbox="491 470 1203 494"><b>▲ WARNING</b> There is a risk of skidding if EBD or ABS is malfunctioning</p> <p data-bbox="491 508 851 532">The wheels may lock during braking.</p> <p data-bbox="491 542 1618 594">The steerability and braking characteristics are heavily impaired and the braking distance may increase. In addition, other driving safety systems are switched off.</p> <ul style="list-style-type: none"> <li data-bbox="491 605 707 628">► Drive on carefully.</li> <li data-bbox="491 639 1299 663">► Have the brake system checked immediately at a qualified specialist workshop.</li> </ul> </div>
 <p data-bbox="144 781 334 804">ESP® warning lamp</p>	<p data-bbox="463 687 1143 750">* The yellow ESP® warning lamp flashes while the vehicle is in motion. or</p> <p data-bbox="476 760 1097 784">The yellow ESP® warning lamp is lit while the vehicle is running.</p> <p data-bbox="476 794 1143 818"><b>The yellow ESP® warning lamp flashes while the vehicle is in motion:</b></p> <p data-bbox="476 828 1105 852">One or more wheels have reached their grip limit (→ page 157).</p> <p data-bbox="476 862 1136 886">► Adapt your driving style to suit the road and weather conditions.</p>



Warning/indicator lamp	Possible causes/consequences and ► Solutions
	<p>The yellow ESP® warning lamp is lit while the vehicle is running.</p> <p>ESP® is malfunctioning.</p> <p>Other driving systems and driving safety systems (e.g. BAS) may also be malfunctioning.</p> <p>► Note the messages on the instrument display.</p> <p><b>▲ WARNING</b> Risk of skidding if ESP® is malfunctioning</p> <p>If ESP® is malfunctioning, ESP® cannot carry out vehicle stabilization. In addition, other driving safety systems are switched off.</p> <ul style="list-style-type: none"> <li>► Drive on carefully.</li> <li>► Have ESP® checked at a qualified specialist workshop.</li> </ul>
 <p>ESP® OFF warning lamp</p>	<p>* The yellow ESP® OFF warning lamp is lit while the vehicle is running.</p> <p>ESP® is deactivated.</p> <p>Other driving systems and driving safety systems may also be inoperative.</p> <p><b>▲ WARNING</b> Risk of skidding when driving with ESP® deactivated</p> <p>ESP® does not act to stabilize the vehicle. The availability of further driving safety systems is also limited.</p> <ul style="list-style-type: none"> <li>► Drive on carefully.</li> <li>► Deactivate ESP® only for as long as the situation requires.</li> </ul>

Warning/indicator lamp	Possible causes/consequences and ► Solutions
	<p>If ESP® cannot be activated, ESP® is malfunctioning.</p> <ul style="list-style-type: none"><li>► Have ESP® checked immediately at a qualified specialist workshop.</li></ul> <p>► Observe the notes on deactivating ESP® (→ page 157).</p>

### Tire pressure monitor

Warning/indicator lamp	Possible causes/consequences and ► Solutions
 <p>Tire pressure monitoring system warning lamp</p>	<p>*The yellow tire pressure monitor warning lamp (pressure loss/malfunction) flashes for approximately one minute and then remains lit.</p> <p>or</p> <p>The yellow tire pressure monitoring system warning lamp (pressure loss/malfunction) is lit.</p> <p><b>The yellow tire pressure monitor warning lamp (pressure loss/malfunction) flashes for approximately one minute and then remains lit:</b></p> <p>The tire pressure monitor is malfunctioning.</p> <p><b>▲ WARNING</b> There is a risk of an accident if the tire pressure monitoring system is malfunctioning</p> <p>The tire pressure monitoring system cannot issue a warning if there is pressure loss in one or more of the tires. Tires with insufficient tire pressure may impair the driving characteristics as well as steering and braking.</p>

Warning/indicator lamp	Possible causes/consequences and ► Solutions
	<p data-bbox="545 253 1681 290">► Have the tire pressure monitoring system checked at a qualified specialist workshop.</p> <p data-bbox="526 305 1413 336"><b>The yellow tire pressure monitoring system warning lamp (pressure loss/malfunction) is lit:</b></p> <p data-bbox="526 341 1450 367">The tire pressure monitoring system has detected tire pressure loss in at least one of the tires.</p> <p data-bbox="545 388 1681 419"><b>⚠ WARNING</b> Risk of an accident due to insufficient tire pressure</p> <ul data-bbox="554 429 1432 528" style="list-style-type: none"><li>• The tires can burst.</li><li>• The tires can wear excessively and/or unevenly.</li><li>• The driving characteristics as well as the steering and braking may be greatly impaired.</li></ul> <p data-bbox="545 543 951 569">You could then lose control of the vehicle.</p> <p data-bbox="545 574 997 600">► Observe the recommended tire pressures.</p> <p data-bbox="545 606 942 637">► Adjust the tire pressure if necessary.</p> <p data-bbox="526 663 1127 688">► Stop the vehicle in accordance with the traffic conditions.</p> <p data-bbox="526 694 933 725">► Check the tire pressure and the tires.</p>

- 1, 2, 3 ...
- (SmartKey) battery..... 65
- 360° Camera**
- Function..... 191
  - Setting favorites..... 194
- A**
- A/C function**
- Activating/deactivating (operating unit)..... 125
- ABS (Anti-lock Braking System), Anti-lock braking system..... 157**
- Acceleration**
- Kickdown..... 144
  - Optimized acceleration..... 132
- Accident and Breakdown Management**
- Mercedes me connect..... 292
- Accident, emergency call..... 293**
- Activating/deactivating automatic volume adjustment**
- Burmester® surround sound system..... 319
- Activating/deactivating the acoustic locking verification signal..... 64**
- Active Blind Spot Assist**
- Brake application..... 183
  - Function..... 181
- Active Brake Assist**
- Function..... 175
  - Setting..... 179
- Active Distance Assist DISTRONIC**
- Activating..... 167
  - Active Emergency Stop Assist..... 173
  - Active Lane Change Assist..... 174
  - Calling up a speed..... 167
  - Deactivating..... 167
  - Function..... 164
  - Increases/reduces the speed..... 167
  - Route-based speed adaptation..... 169
  - Storing a speed..... 167
- Active Emergency Stop Assist,**
- Driving system..... 173
- Active headlamps..... 115**
- Active Lane Change Assist**
- Activating/deactivating..... 175
  - Function..... 174
- Active Lane Keeping Assist**
- Activating/deactivating..... 186
  - Activating/deactivating the warning..... 187
  - Function..... 184
- Active Parking Assist, Parking assistance systems**
- Exiting a parking space..... 201
  - Parking..... 199
- Active Service System PLUS, ASSYST PLUS..... 321**
- Active Speed Limit Assist..... 168**
- Active Steering Assist**
- Activating/deactivating..... 172
  - Active Emergency Stop Assist..... 173
  - Active Lane Change Assist..... 174
  - Function..... 170
- Adaptive cruise control, Active Distance Assist DISTRONIC..... 169**
- Adaptive Highbeam Assist, High beam**
- Activating/deactivating..... 116
  - Function..... 115
- Additives**
- Engine oil..... 394
  - Fuel..... 394

- Adjusting bass, mid-range and treble settings**  
 Advanced sound system..... 319
- Adjusting mid-range, treble and bass settings**  
 Advanced sound system..... 319
- Adjusting the balance/fader**  
 Advanced sound system..... 320  
 Burmester® surround sound system..... 319
- Adjusting the bass, mid-range and treble**  
 Burmester® surround sound system..... 319
- Adjusting the mid-range, treble and bass**  
 Burmester® surround sound system..... 319
- Adjusting the sound focus**  
 Burmester® surround sound system..... 319
- Adjusting treble, mid-range and bass settings**  
 Advanced sound system..... 319  
 Burmester® surround sound system..... 319
- ADS PLUS damping system, AIRMATIC**  
 AIRMATIC..... 187
- Advanced sound system**  
 Adjusting the balance/fader..... 320
- Adjusting treble, mid-range and bass settings..... 319  
 Calling up the sound menu..... 319  
 Information..... 319  
 Switching loudness normalization on/off..... 320
- After-sales service, ASSYST PLUS..... 321**
- Air bag**  
 Deployment..... 37  
 Reduced protection..... 45
- Air conditioning menu**  
 Ionization..... 125
- Air distribution**  
 Setting..... 124
- Air freshener system..... 126**
- Air inlet..... 328**
- Air pressure..... 358**
- Air vents**  
 Setting..... 127
- Air/water duct..... 328**
- Airbag, Occupant safety**  
 Automatic front passenger airbag shut off..... 46
- Front airbag (driver, front passenger)..... 43  
 Installation locations..... 43  
 Knee airbag..... 43  
 Overview..... 43  
 PASSENGER AIR BAG indicator lamps..... 47  
 Protection..... 44  
 Side airbag..... 43  
 Window curtain airbag..... 43
- Airflow**  
 Setting..... 124
- AIRMATIC**  
 Air suspension..... 187  
 Vehicle level..... 187
- Alarm system, ATA..... 83**
- All-wheel drive, 4MATIC..... 144**
- Alternative route..... 256**
- Ambient lighting..... 117**
- Android Auto**  
 Connecting a mobile phone (wireless).... 286  
 Ending..... 287  
 Information..... 286  
 Sound settings..... 287  
 Transferred vehicle data..... 287

- Android smartphone**, Android Auto..... 285
- Animals**  
 Pets in the vehicle..... 62
- Anti-lock braking system**, ABS..... 157
- Anti-theft alarm system**, ATA..... 83
- Anti-theft protection**, ATA  
 Immobilizer..... 82
- Apple CarPlay®**  
 Connecting an iPhone® (cable)..... 285  
 Ending..... 285  
 Notes..... 284  
 Overview..... 284  
 Sound settings..... 285  
 Transferred vehicle data..... 287
- Approval numbers**..... 389
- Assistance systems**..... 156
- ASSYST PLUS**  
 Battery disconnection periods..... 322  
 Service interval display..... 321  
 Service requirements..... 321
- ATA**  
 Deactivating the alarm..... 83  
 Function..... 83
- Interior protection..... 85  
 Tow-away alarm..... 84  
 Tow-away protection..... 84
- ATA (anti-theft alarm system)**  
 Interior protection function..... 84
- ATTENTION ASSIST**, Attention assistant  
 Function..... 161  
 Setting..... 162
- Audio mode**  
 Activating media mode..... 300  
 Connecting USB devices..... 302  
 Copyright..... 300  
 Information..... 298  
 Inserting/removing an SD card..... 300  
 Media search..... 306  
 Overview..... 302  
 Pause and playback function..... 303  
 Selecting a track..... 303  
 Selecting playback options..... 303  
 Track list..... 303
- Authorized Mercedes-Benz Service Center**.... 27
- Authorized workshop**..... 27
- Automatic car wash**..... 328
- Automatic car wash mode**..... 328
- Automatic climate control**..... 125
- Automatic distance control**, Active Distance Assist DISTRONIC, DISTRONIC..... 164
- Automatic driving lights**..... 113
- Automatic engine start/stop**  
 ECO start/stop function..... 136
- Automatic front passenger air bag deactivation system**  
 Function..... 46
- Automatic front passenger airbag shutoff**, PASSENGER AIR BAG status display  
 PASSENGER AIR BAG indicator lamps..... 47
- Automatic mirror folding function**..... 123
- Automatic transmission**  
 Changing gears..... 140  
 DIRECT SELECT lever..... 140  
 Drive programs..... 138  
 DYNAMIC SELECT switch..... 138  
 Engaging drive position..... 142  
 Kickdown..... 144  
 Manual gear shifting..... 143  
 Steering wheel paddle shifters..... 143  
 Transmission position display..... 140  
 Transmission positions..... 140





















- Autonomous braking**..... 175
- B**
- Bag hook**..... 105
- BAS, Brake Assist System**..... 157
- Battery (12 V battery)**
- Charging..... 347
  - Notes..... 344
  - Replacing..... 349
  - Starting assistance..... 345
- Battery (starter battery)**
- charging, Remote Online..... 130
- Belt**..... 38
- Blind Spot Assist, Active Blind Spot Assist**
- Activating/deactivating..... 184
  - Function..... 181
- Bluetooth®**, System settings
- Activating/deactivating..... 236
  - Information..... 235
- Bluetooth® audio**
- Activating..... 310
  - De-authorizing (de-registering) the device..... 311
  - Overview..... 309
  - Searching for a track..... 311
  - Searching for and authorizing the device..... 309
  - Selecting a media player..... 310
  - Switching device via NFC..... 311
- Bluetooth® Audio (multimedia system)**
- Information..... 308
- Brake Assist**
- Active Brake Assist..... 175
  - Brake Assist System (BAS)..... 157
- Brake Assist System, BAS**..... 157
- Brake fittings**..... 131
- Brake fluid**..... 395
- Brake force distribution, EBD**..... 159
- Brakes**
- ABS (Anti-lock Braking System)..... 157
  - ABS, BAS, EBD..... 156
  - Active Brake Assist..... 175
  - Breaking-in notes..... 131
  - Driving tips..... 133
  - HOLD function..... 159
  - Limited braking effect (salt-treated roads)..... 133
  - New/replaced brake linings/brake discs..... 131
- Braking assistance, Brake Assist System**..... 157
- Breakdown**
- Changing a wheel..... 380
  - Flat tire..... 337
  - Overview of the help functions..... 18
  - Tow-starting..... 353
  - Towing away..... 350
  - Transporting the vehicle..... 351
- Breakdown (Roadside Assistance)**..... 24
- Breaking-in notes**..... 131
- Burmester® surround sound system**
- Adjusting the balance/fader..... 319
  - Adjusting the sound focus..... 319
  - Adjusting treble, mid-range and bass settings..... 319
  - Automatic volume adjustment..... 319
  - Calls up the sound menu..... 318
  - Information..... 318
  - Switching the surround sound on/off..... 319







































- C**
- Call list**  
 Making a call..... 281  
 Overview..... 281
- Calling up the sound menu**  
 Advanced sound system..... 319
- Calls, Telephone operation**  
 Accepting..... 278  
 Activating functions during a call..... 278  
 Calls with several participants..... 278  
 Declining..... 278  
 Ending a call..... 278  
 Incoming call during an existing call..... 278  
 Making..... 278  
 Mercedes me..... 288
- Calls up the sound menu**  
 Burmester® surround sound system..... 318
- Camera**  
 360° Camera..... 191  
 Information..... 155  
 Rear view camera..... 189  
 Select view..... 194
- Car key**..... 63
- Car wash**..... 328
- Care**  
 Air/water duct..... 328  
 Automatic car wash..... 328  
 Decorative foil..... 331  
 Display..... 333  
 Exterior lighting..... 332  
 Head-up display..... 333  
 Headliner..... 333  
 Paint..... 330  
 Plastic trim..... 333  
 Power washers..... 329  
 Real wood/trim elements..... 333  
 Surround view camera..... 332  
 Tailpipes..... 332  
 Vehicle interior..... 333  
 Vehicle parts..... 332  
 Washing by hand..... 330
- Cargo tie-down rings**..... 104
- Caring for plastic trim**..... 333
- Caring for real wood**..... 333
- Caring for rims**..... 332
- Caring for the steering wheel**..... 333
- Caring for trim elements**..... 333
- Central locking system**  
 Button..... 67  
 SmartKey..... 64
- Change of address**..... 24
- Change of ownership**..... 24
- Changing a wheel**  
 Preparation..... 380  
 Raising the vehicle..... 382  
 Removing a wheel..... 384
- Character entry**  
 Using the controller..... 233
- Charging**  
 12 V battery..... 347
- Checking the coolant level**..... 327
- Child seat**  
 Basic instructions..... 51  
 Front passenger seat..... 60  
 Installing ISOFIX..... 56  
 Risks/dangers..... 52  
 Securing..... 55  
 Securing on the rear seat with the seat belt..... 59  
 Securing to the front passenger seat with the seat belt..... 61



- Top Tether..... 58
- Children**
- Avoiding dangers in the vehicle..... 52
- Basic instructions..... 51
- Special seat belt retractor..... 55
- Chock**..... 380
- Clean varnish**..... 330
- Cleaning**
- Air/water duct..... 328
- Automatic car wash..... 328
- Decorative foil..... 331
- Paint..... 330
- Power washers..... 329
- Vehicle interior..... 333
- Vehicle parts..... 332
- Cleaning carpets**..... 333
- Cleaning seat covers**..... 333
- Climate control**
- Activating/deactivating..... 124
- Activating/deactivating the A/C function (control panel)..... 125
- Activating/deactivating the synchronization function (control panel)..... 125
- Automatic control..... 125
- Control panel for 3-zone automatic climate control..... 124
- Control panel for dual-zone automatic climate control..... 124
- Defrosting the windshield..... 124
- Filling capacity for refrigerant and PAG oil..... 398
- Fragrance system..... 126
- Front air vents..... 127
- Inserting/removing the flacon (fragrance system)..... 126
- Ionization..... 125
- Notes..... 124
- Rear passenger compartment air vents.. 127
- Refrigerant..... 397
- Removing condensation from the windows..... 125
- Setting the air distribution..... 124
- Setting the airflow..... 124
- Setting the vehicle interior temperature..... 124
- Switching air-recirculation mode on/off..... 125
- Switching the rear window heater on/off..... 124
- Ventilating with convenience opening..... 77
- COC papers, CERTIFICATE OF CONFORMITY**..... 388
- Cockpit**
- Dashboard..... 6
- Coffee cup symbol, ATTENTION ASSIST**..... 161
- Collision detection (parked vehicle)**
- Information..... 153
- COMAND Touch**
- Managing devices..... 238
- Combination switch**
- Lights..... 113
- Windshield wiper..... 118
- Compass**..... 270
- Component-specific information**..... 390
- Connecting the parcel net**..... 106
- Connection status**
- Displaying..... 296
- Overview..... 296
- Contacts**
- Calling up..... 279
- Deleting..... 281
- Downloading (from mobile phone)..... 279
- Importing..... 280

- Importing (overview)..... 280
  - Information..... 279
  - Making a call..... 280
  - Name format..... 279
  - Options..... 280
  - Storing..... 280
  - Controller**
    - Operating..... 227
  - Convenience closing**..... 77
  - Convenience opening**..... 77
  - Coolant**..... 396
  - Coolant (engine)**
    - Capacity..... 396
  - Copyright**
    - License..... 34
  - Copyrights**
    - Trademarks..... 34
  - Cornering light**..... 115
  - Correct use**..... 28
  - Cover, Roller sunblind**..... 79
  - Cross Traffic Alert, Cross traffic warning**..... 203
  - Crosswind Assist, ESP®**..... 158
  - Cruise control**
    - Activating..... 163
    - Calling up a speed..... 163
    - Deactivating..... 163
    - Function..... 162
    - Requirements..... 163
    - Setting a speed..... 163
    - Storing a speed..... 163
  - Customer Assistance Center (CAC)**..... 28
  - Customer Relations Department**..... 28
- D**
- Dashboard**
    - Cockpit..... 6
  - Data import/export, System settings**
    - Function/notes..... 240
    - Importing/exporting..... 240
  - Data processing in the vehicle**..... 30
  - Data protection rights**..... 33
  - Data storage**
    - Data protection rights..... 33
    - Electronic control units..... 30
    - Event Data Recorder..... 33
  - Multimedia system / Mercedes me connect..... 33
  - Online services..... 32
  - Date**
    - Setting the time and date automatically..... 234
  - Daytime running lamps, Daytime running lamp mode**
    - Activating/deactivating..... 117
  - Deactivating the alarm**..... 83
  - Dealership**..... 27
  - Declaration of conformity**
    - Wireless vehicle components..... 26
  - Decorative foil**..... 331
  - Definitions**
    - Tires and loading..... 374
  - Destination**
    - Editing intermediate destinations..... 251
    - Editing the previous destinations..... 262
    - External..... 262
    - Saving (current vehicle position)..... 262
    - Saving as a favorite..... 262
    - Saving as global favorite..... 262

- Storing a map position..... 262
- Destination entry**
- Entering a 3 word address..... 252
  - Entering a POI or address..... 247
  - Entering an intermediate destination..... 251
  - Entering geo-coordinates..... 252
  - Selecting a contact..... 252
  - Selecting from the map..... 253
  - Selecting previous destinations..... 250
- Destination entry (multimedia system)**
- Selecting a POI..... 250
- Detecting inattentiveness,**
- ATTENTION ASSIST..... 161
- Diagnostics connection**..... 26
- Digital Operator's Manual**..... 20
- Dinghy towing, Tow bar system**
- Pulling/towing..... 203
- DIRECT SELECT lever**
- Automatic transmission..... 140
  - Engaging neutral..... 141
  - Engaging park position automatically..... 142
  - Engaging reverse gear..... 141
  - Function..... 140
  - Gearshift recommendation..... 143
- Manual gearshifting..... 143
- Selecting park position..... 142
- Display**
- Care..... 333
- Display (multimedia system)**
- Settings..... 234
- Display (on-board computer)**
- Displays on the instrument display..... 208
- Display message**
- Calling up in the on-board computer..... 400
- Display messages**
-  --- mph..... 425
  -  --- mph..... 425
  -  12 V Battery See Operator's Manual..... 441
  -  Active Headlamps Inoperative..... 407
  -  ATTENTION ASSIST Inoperative..... 424
  -  ATTENTION ASSIST: Take a Break!..... 425
  -  Automatic Headlamp Mode Inoperative..... 407
-  Check Brake Fluid Level..... 423
-  Check Coolant Level See Operator's Manual..... 414
-  Check Engine Oil At Next Refueling..... 448
-  Check Engine Oil Level (Add 1 quart)..... 448
-  Check Left Low Beam (example)... 406
-  Check Tires..... 444
-  Check Washer Fluid..... 413
-  Coolant Too Hot Stop Vehicle Turn Engine Off..... 415
-  Currently Unavailable See Operator's Manual..... 435
-  Currently Unavailable See Operator's Manual..... 437
-  Don't Forget Your Key..... 406
-  Drive More Slowly..... 434
-  Engine Oil Level Cannot Be Measured..... 450

-  Engine Oil Level Low Stop Vehicle Turn Engine Off..... 449
-  Engine Oil Pressure Stop Switch Off Engine..... 450
-  Engine Oil Reduce Oil Level..... 449
-  Front Left Malfunction Service Required (example)..... 401
-  Front Left Seat Backrest Not Locked (example)..... 413
-  Fuel Level Low..... 416
-  Gas Cap Loose..... 416
-  Inoperative See Operator's Manual..... 436
-  Inoperative See Operator's Manual..... 437
-  Inoperative See Operator's Manual..... 438
-  Inoperative..... 440
-  Intell. Light System Inoperative..... 408
-  Key Being Initialized Please Wait... 405
-  Key Not Detected (Red display message)..... 405
-  Key Not Detected (white display message)..... 404
-  Left Side Curtain Airbag Malfunction Service Required (example)..... 401
-  Lowering..... 434
-  Malfunction Drive at Max. 50 mph..... 432
-  Malfunction See Operator's Manual..... 407
-  Obtain a New Key..... 404
-  Off..... 426
-  Off..... 424
-  Parking Brake See Operator's Manual..... 419
-  Please Correct Tire Pressure..... 444
-  Please Release Parking Brake..... 422
-  Rear Left Backrest Not Latched (example)..... 413
-  Replace Key Battery..... 404
-  See Operator's Manual..... 441
-  SRS Malfunction Service Required..... 401
-  Steering Malfunction Increased Physical Effort See Operator's Manual... 411
-  Steering Malfunction Stop Immediately See Operator's Manual..... 411
-  Stop Vehicle Leave Engine Running..... 442
-  Stop Vehicle See Operator's Manual..... 442
-  Stop Vehicle Vehicle Too Low..... 433
-  Suspended..... 426
-  Switch Off Lights..... 408
-  Switch On Headlamps..... 407
-  Turn On the Ignition to Release the Parking Brake..... 423
-  Vehicle Ready to Drive Switch the Ignition Off Before Exiting..... 410

-  Vehicle Rising Please Wait..... 434
-  Vehicle Rising..... 434
-  Warning Tire Malfunction..... 445
-  Wheel Sensor(s) Missing..... 443
- Active Blind Spot Assist Currently Unavailable See Operator's Manual..... 430
- Active Blind Spot Assist Inoperative..... 430
- Active Brake Assist Functions Currently Limited See Operator's Manual.... 438
- Active Brake Assist Functions Limited See Operator's Manual..... 439
- Active Distance Assist Currently Unavailable See Operator's Manual..... 426
- Active Distance Assist Inoperative..... 426
- Active Distance Assist Now Available..... 427
- Active Lane Keeping Assist Camera View Restricted See Operator's Manual..... 432
- Active Lane Keeping Assist Currently Unavailable See Operator's Manual..... 431
- Active Lane Keeping Assist Inoperative... 431
- Active Steering Assist Currently Unavailable Due to Multiple Emergency Stops..... 428
- Active Steering Assist Currently Unavailable See Operator's Manual..... 427
- Active Steering Assist Inoperative..... 427
- Adaptive Highbeam Assist Camera View Restricted See Operator's Manual..... 409
- Adaptive Highbeam Assist Currently Unavailable See Operator's Manual..... 408
- Adaptive Highbeam Assist Inoperative... 408
- Apply Brake to Shift from 'P'..... 416
- Apply Brake to Shift to 'R'..... 417
- Auxiliary Battery Malfunction (red display message)..... 419
- Auxiliary Battery Malfunction (white display message)..... 418
- Beginning Emergency Stop..... 428
- Blind Spot Assist Currently Unavailable See Operator's Manual..... 429
- Blind Spot Assist Inoperative..... 430
- Cannot Start Engine See Operator's Manual..... 414
- Check Brake Pads See Operator's Manual..... 424
- Check Tire Pressure Soon..... 446
- Check Tire Pressure Then Restart Run Flat Indicator..... 447
- Cruise Control Inoperative..... 425
- Cruise Control Off..... 425
- Decrease Speed..... 446
- Driver's Door Open & Transmission Not in P Risk of Vehicle Rolling Away..... 417
- Front Passenger Airbag Disabled See Operator's Manual..... 402
- Front Passenger Airbag Enabled See Operator's Manual..... 402

- Hazard Warning Flashers Malfunctioning..... 409
- Head-up Display Currently Unavailable See Operator's Manual..... 410
- Head-up Display Inoperative..... 410
- Mercedes me connect Services Limited See Operator's Manual..... 440
- N Permanently Active Risk of Rolling Away..... 417
- Only Shift to 'P' when Vehicle is Stationary..... 416
- Parking Assist and PARKTRONIC Inoperative See Operator's Manual..... 435
- Parking Assist Maneuvering Assistance Restricted See Operator's Manual..... 435
- Place the Key in the Marked Space See Operator's Manual..... 406
- PRE-SAFE Inoperative See Operator's Manual..... 403
- Radar Sensors Dirty See Operator's Manual..... 439
- Reversing Not Possible Service Required..... 418
- Run Flat Indicator Inoperative..... 447
- Service Required Do Not Shift Gears Visit Dealer..... 417
- Stop Vehicle Leave Engine Running Wait Transmission Cooling..... 418
- Tire Press. Monitor Currently Unavailable..... 443
- Tire Press. Monitor Inoperative..... 443
- Tire Pressure Monitor Inoperative No Wheel Sensors..... 443
- Tires Overheated..... 445
- To Deselect P or N, Depress Brake and Start Engine..... 417
- To switch engine off, press and hold Start/Stop button for at least 3 secs. or press 3 times..... 414
- Traffic Sign Assist Camera View Restricted See Operator's Manual..... 429
- Traffic Sign Assist Currently Unavailable See Operator's Manual..... 428
- Traffic Sign Assist Inoperative..... 429
- Transmission Malfunction Stop..... 418
- Wiper Malfunctioning..... 413
- Distance control**, Active Distance Assist  
DISTRONIC, DISTRONIC..... 164
- Distance warning**, Active Brake Assist..... 175
- DISTRONIC**  
Activating..... 167  
Active Distance Assist..... 164  
Deactivating the variable limiter..... 167
- Door**  
Emergency key..... 69  
Opening (from the inside)..... 67  
Unlocking (inside)..... 67
- Door operating unit**  
Function seat..... 16
- DOT, Tire Identification Number (TIN)**..... 370

- Double pulse**  
Accelerator pedal..... 144
- Drinking and driving**..... 133
- Drive Away Assist, Drive Away Assist**..... 202
- Drive position**  
DIRECT SELECT lever..... 142  
Engaging..... 142
- Drive program display**..... 139
- Driver's display**  
Head-up display..... 208
- Driver's seat**  
Adjusting electrically..... 89  
Easy entry and exit feature..... 97  
Manual and electrical adjustment..... 87  
Seat heating..... 94
- Driving safety system, Assistance systems, Driving system, Safety systems**  
Active Blind Spot Assist..... 181  
Active Brake Assist..... 175  
ATTENTION ASSIST..... 161  
BAS..... 157  
Cameras..... 155  
Cruise control..... 162  
EBD (Electronic Brakeforce Distribution)..... 159  
ESP® (Electronic Stability Program)..... 157  
Hill start assist..... 160  
HOLD function..... 159  
Overview..... 156  
Radar and ultrasonic sensors..... 155  
STEER CONTROL..... 159  
Traffic Sign Assist..... 180
- Driving system**  
DYNAMIC BODY CONTROL..... 187
- Driving tips**  
Drinking and driving..... 133  
Optimized acceleration..... 132
- Drowsiness detection, ATTENTION ASSIST**... 161
- Duplicate key**..... 66
- DYNAMIC BODY CONTROL**  
Suspension..... 187
- Dynamic handling control system, ESP®**..... 157
- DYNAMIC SELECT**  
Configuring drive program I..... 140  
Displaying engine data..... 140  
Displaying vehicle data..... 140
- Drive program display..... 139  
Drive programs..... 138  
Function..... 138  
Operating (button)..... 139  
Selecting a drive program..... 139  
Showing operation feedback..... 140
- E**
- E10**..... 393
- Easy entry feature**..... 97, 98
- Easy exit feature**..... 97, 98
- EBD, Electronic Brakeforce Distribution**..... 159
- ECO display**..... 138
- ECO start/stop button**  
Automatic engine start/stop..... 137
- ECO start/stop function**  
Automatic engine start..... 136  
Automatic engine stop..... 136  
Function..... 136  
Switching off/on..... 137
- Electric parking brake**  
Automatic..... 151  
Emergency braking..... 153

- Manual..... 153
- Electrical fuses**..... 354
- Electronic Stability Program, ESP®**..... 157
- Emergency**
- First-aid kit (soft sided)..... 337
  - Overview of the help functions..... 18
  - Reflective safety vest..... 336
  - Warning triangle..... 337
- Emergency braking**
- Electric parking brake/hand brake..... 151
- Emergency key**
- Door..... 69
- Emergency operation mode**
- Starting the vehicle..... 130
- Emergency release**
- Trunk lid (from inside)..... 75
- Emergency stop assistant, Active Emergency Stop Assist**..... 173
- Emergency Tensioning Devices**
- Deployment..... 37
- ENERGIZING COMFORT**
- Overview of programs..... 245
  - Starting the program..... 245
- Engine**
- Emergency operation mode..... 130
  - Emergency start..... 353
  - Engine number..... 390
  - Starting assistance..... 345
  - Switching off, start/stop button..... 147
- Engine data**
- Displaying..... 140
  - DYNAMIC SELECT..... 140
- Engine number**..... 390
- Engine oil**
- Additives..... 394
  - Capacity..... 395
  - Checking the oil level using the oil dipstick..... 324
  - Checking the oil level using the on-board computer..... 325
  - MB-Freigabe or MB-Approval..... 395
  - Quality..... 395
  - Refilling..... 325
- Entering characters, MBUX multimedia system**
- Function/notes..... 232
  - On the touchpad..... 233
- Environmental protection**..... 21
- Environmentally friendly driving**..... 21
- Error message**
- Instrument cluster..... 400
- ESC, Electronic Stability Control**..... 157
- ESP®, Electronic Stability Program**
- Activating/deactivating..... 159
  - Crosswind Assist..... 158
  - Function..... 157
- Event Data Recorder**..... 33
- Exiting a parking space**..... 194
- Exterior lighting**
- Care..... 332
- Exterior mirrors**
- Parking position..... 122
- F**
- Factory settings**
- MBUX..... 244
- Favorites**
- Calling up..... 229
  - Deleting..... 230



- Moving..... 230  
Renaming..... 230
- Favourites**, MBUX multimedia system  
Overview..... 229
- First aid**  
First-aid kit (soft sided)..... 337
- First-aid kit (soft sided)**..... 337
- Flacon**..... 126
- Flat tire**  
Changing a wheel..... 380  
MOExtended..... 338  
Notes..... 337  
TIREFIT kit..... 339
- Flat towing**, Tow bar system  
Pulling/towing..... 203
- Floor mats**..... 110
- Foil covering**  
On camera/sensors..... 155  
Radar and ultrasonic sensors..... 155
- Fragrance**..... 126
- Fragrance system**  
Inserting/removing the flacon..... 126  
Perfume vial..... 126
- Free software**, Open Source Software..... 34
- Frequencies**  
Two-way radio..... 389
- Front airbag (driver, front passenger)**..... 43
- Front fog lights**..... 113
- Front headlamps**..... 112
- Front passenger air bag deactivation system**, PASSENGER AIR BAG OFF..... 46
- Front passenger seat**  
Adjusting electrically..... 89  
Manual and electrical adjustment..... 87
- Fuel**  
Additives..... 394  
E10..... 393  
Gasoline..... 393  
Gasoline quality..... 393  
Refilling..... 145  
Reserve..... 394  
Sulfur content..... 393  
Tank content..... 394
- Fuel filler cap / flap**..... 145
- Fuel reserve**..... 394
- Function seat**..... 16
- Fuses**  
Cockpit..... 356  
Engine compartment..... 355  
Front passenger footwell..... 356  
Fuse assignment diagram..... 354  
Notes..... 354  
Trunk..... 356
- G**
- Garage door opener**  
Clearing the memory..... 151  
Opening/closing a door..... 151
- Garage door openers**  
Programming buttons..... 149  
Resolving problems..... 151  
Synchronizing the rolling code..... 150
- Gas station search**  
Starting automatic search..... 250  
Switching the automatic search on/off... 256  
Using automatic search..... 256
- Gasoline**..... 393
- Gearshift**  
Automatic transmission..... 143  
Manual..... 143

- General driving tips**..... 133  
**Genuine parts**..... 21  
**Glide mode**..... 144  
**Glove box**..... 102
- H**
- Handbrake**, Electric parking brake..... 151  
**Handling characteristics**  
   Unusual..... 357  
**HANDS-FREE ACCESS**..... 73  
**Hazard warning light system**..... 114  
**Hazard warning lights**..... 114  
**Head restraint**  
   Adjusting (rear passenger compartment)..... 91  
   Adjusting manually (front)..... 90  
   Removing/installing (rear passenger compartment)..... 91  
**Head-up display**, Display on the windshield  
   Adjusting brightness (on-board computer)..... 209  
   Adjusting display elements (on-board computer)..... 209  
   Care..... 333  
   Function..... 208  
   Memory function..... 99  
   Menu (on-board computer)..... 209  
   Setting the position (on-board computer)..... 209  
   Switching on/off..... 210  
**Headlamp flashing**..... 113  
**Headlamps**  
   Automatic..... 112  
**Headliner**..... 333  
**Heating**  
   Activating/deactivating..... 124  
   Seat..... 94  
**Help call**  
   Mercedes-Benz emergency call system.. 293  
**High beam**  
   Activating/deactivating..... 113  
**Hill start assist**..... 160  
**HOLD function**, Roll away protection  
   Switching on/off..... 160  
**Hood**  
   Opening/closing..... 322  
**Hotspot**  
   Setting up (Wi-Fi)..... 237
- I**
- Identification plate**  
   Engine..... 390  
   Refrigerant..... 397  
   Vehicle..... 390  
**Immobilizer**..... 82  
**Indicator/warning lamps**..... 450  
**Individual drive program**  
   Configuring..... 140  
**Inside rearview mirror**, Rearview mirror..... 121  
**Installing**  
   Snow chains..... 358  
   Tires..... 384  
   Wheels..... 384  
**Instrument cluster**  
   Function/notes..... 206  
**Instrument display**, Instrument cluster  
   Buttons..... 207

- Function/notes..... 206
- Head-up display menu..... 209
- Instrument cluster..... 10
- Notes..... 205
- Overview of displays..... 208
- Warning/indicator lamps..... 450
- Intelligent Light System**
  - Active headlamps..... 115
  - Adaptive Highbeam Assist..... 115
  - Cornering light..... 115
- Interior lighting**
  - Ambient lighting..... 117
  - Setting..... 117
  - Switch-off delay time..... 118
- Interior protection**..... 85
- Intermediate destination**
  - Calculating a route with intermediate destinations..... 252
  - Editing..... 251
  - Starting an automatic gas station search..... 250
  - Starting the automatic service station search..... 257
- Internet connection**
  - Communication module function..... 295
  - Displaying the connection status..... 296
  - Information..... 295
  - Overview of connection status..... 296
  - Restrictions..... 295
- Ionization**
  - Activating/deactivating (multimedia system)..... 125
- iPhone®**
  - Smartphone integration..... 284
- ISOFIX child seat anchor**
  - Installing..... 56
- J**
- Jack**..... 380
- Jump-start connection**..... 347
- K**
- Key**
  - Acoustic locking verification signal..... 64
- KEYLESS-GO**
  - Deactivating..... 64
- Locking/unlocking the vehicle..... 67
- Problem..... 68
- Unlocking setting..... 64
- Kickdown, Acceleration**
  - Using..... 144
- Knee airbag**..... 43
- L**
- Lamp**
  - Interior lighting..... 117
- Lane change assist, Active Lane Change Assist**..... 174
- Lane Keeping Assist, Active Lane Keeping Assist**..... 184
- Lane recognition**
  - Active Lane Change Assist..... 174
- Lane recognition (automatic)**
  - Active Lane Keeping Assist..... 184
- Language, System settings**
  - Notes..... 239
  - Setting..... 239
- Level control, AIRMATIC**..... 187, 188
- Light switch**..... 112

- Lighting**  
 Interior lighting..... 117
- Lights**  
 Active headlamps..... 115  
 Adaptive Highbeam Assist..... 115  
 Automatic driving lights..... 113  
 Combination switch..... 113  
 Cornering light..... 115  
 Hazard warning lights..... 114  
 High beam..... 113  
 Low beam..... 112  
 Parking lights..... 112  
 Rear fog light..... 112, 113  
 Responsibility for lighting systems..... 112  
 Setting the surround lighting..... 117  
 Standing lights..... 112  
 Switch-off delay time..... 117  
 Turn signal light..... 113
- Limited Warranty**..... 30
- Live Traffic Information**  
 Displaying subscription information..... 263  
 Displaying the traffic map..... 264  
 Displaying traffic incidents..... 264  
 Extending a subscription..... 263  
 Issuing hazard alerts..... 265
- Load index**  
 Tires..... 372
- Load-bearing capacity**  
 Tires..... 372
- Loading**  
 Bag hook..... 105  
 Cargo tie-down rings..... 104  
 Definitions..... 374  
 Roof luggage rack..... 106
- Loading guidelines**..... 99
- Loading information table**..... 365
- Loads**  
 Securing..... 99
- Locking an external device (child safety lock)**..... 239
- Locking/unlocking**  
 automatic locking..... 69  
 Doors (from the inside)..... 67  
 Emergency key..... 69  
 KEYLESS-GO..... 67
- Loud sound**  
 PRE-SAFE® Sound..... 50
- Low beam**  
 Activating/deactivating..... 112
- lubricants**..... 392
- Luggage**  
 Parcel net..... 106  
 Securing..... 99
- Luggage rack**..... 99
- Lumbar support, Lumbar support**..... 90
- M**
- Maintaining a safe distance**  
 Active Distance Assist DISTRONIC..... 167
- Maintenance, ASSYST PLUS**  
 Vehicle..... 24
- Malfunction**  
 Restraint system..... 37
- Maneuvering assistance**  
 Activating/deactivating..... 203
- Maneuvering assistant, Cross traffic (warning), Shunting support**  
 Cross Traffic Alert..... 203  
 Drive Away Assist..... 202

- Map**
- Avoiding an area..... 268
  - Avoiding an area (overview)..... 268
  - Changing an area..... 269
  - Deleting an area..... 269
  - Displaying online map contents..... 271
  - Displaying the compass..... 270
  - Displaying the map version..... 268
  - Displaying the next intersecting street.... 268
  - Displaying the satellite map..... 271
  - Displaying the traffic map..... 264
  - Displaying weather information..... 271
  - Map data..... 270
  - Moving..... 267
  - Overview..... 265
  - Selecting POI symbols..... 267
  - Selecting text information..... 267
  - Selecting the map orientation..... 267
  - Setting the map scale..... 266
  - Setting the map scale automatically..... 270
  - Updating..... 269
- Map and compass**
- Overview..... 265
- Message program**..... 92
- Maximum full-stop braking, Brake**
- Assist System..... 157
- Maximum load rating**..... 371
- Maximum permissible load**
- Calculation example..... 367
  - Determining..... 366
- Maximum speeds**..... 399
- Maximum tire pressure**..... 371
- MBUX, Multimedia system**
- Configuring drive program I..... 140
- MBUX multimedia system**
- Calling up applications..... 229
  - Factory setting..... 244
  - Switching the sound on/off..... 230
  - To adjust the volume..... 231
- Mechanical key**
- Inserting/removing..... 65
- Media**
- Searching..... 306
- Media display**
- Notes..... 225
- Media Interface**
- Activating..... 307
  - Information..... 306
  - Overview..... 307
- Media mode**
- Activating..... 300
- Media search**
- Starting..... 306
- Medical aids**..... 28
- Memory function**
- Head-up display..... 99
  - Outside mirrors..... 99
  - Seat..... 99
  - Steering wheel..... 99
- Menu (on-board computer)**
- Head-up display..... 209
  - Overview..... 207
- Mercedes me App**
- Activating on-demand features..... 23
- Mercedes me calls**
- Arranging a service appointment..... 290
  - Calling the Mercedes-Benz Customer Center..... 289
  - Calling the Mercedes-Benz Customer Center after automatic accident or breakdown detection..... 289

- Information..... 288  
 Making a call via the overhead control panel..... 288  
 Transferred data..... 290
- Mercedes me connect**  
 Accident and Breakdown Management... 292  
 Information..... 291  
 Transferred data..... 292
- Mercedes-AMG vehicles**  
 Notes..... 128
- Mercedes-Benz Apps**  
 Calling up..... 296  
 Using with voice control..... 297
- Mercedes-Benz emergency call system**  
 Automatic emergency call..... 293  
 Information..... 292  
 Information about data transfer..... 294  
 Manual emergency call..... 294  
 Overview..... 293
- Mercedes-Benz GenuineParts**..... 21
- Mercedes-Benz Link**  
 Connecting..... 283  
 Ending..... 284  
 Overview..... 283
- Using..... 283
- Message memory**..... 400
- Messages**  
 Voice commands (Voice Control System)..... 221
- Mirrors**  
 Mirror folding function..... 123  
 Outside mirrors..... 120  
 Rearview mirror..... 121
- Mobile phone**  
 Notes on wireless charging..... 108
- Mobile phone voice recognition**  
 Starting..... 277  
 Stopping..... 277
- Model type**..... 390
- MOExtended tires**..... 338
- Multifunction steering wheel**  
 Operation..... 211
- Multimedia system**  
 Activating/deactivating standby mode... 154  
 Central control elements..... 226  
 Display settings..... 234
- ENERGIZING COMFORT program (overview)..... 245  
 Overview..... 225  
 Starting the ENERGIZING COMFORT program..... 245
- N**
- Navigation**  
 Activating..... 246  
 Displaying/hiding the menu..... 247  
 Updating the map data..... 269  
 Voice commands (Voice Control System)..... 214
- Navigation announcements**  
 Activating/deactivating..... 260  
 Repeating..... 261  
 Switching audio fadeout on/off..... 260  
 To adjust the volume..... 260
- Near Field Communication (NFC), NFC**  
 Connecting the mobile phone to the multimedia system..... 276  
 Information..... 276  
 Switching Bluetooth® audio equipment... 311  
 Switching mobile phones..... 276  
 Using a mobile phone..... 276

- Neutral**  
Engaging..... 141
- Non-operational time**  
Activating/deactivating standby mode... 154
- O**
- Occupant safety**..... 38
- On-board computer, Computer, Operating system**  
Displaying the service due date..... 321  
Instrument display..... 208  
Menu overview..... 207  
Operating..... 207
- On-board diagnostics interface, Diagnostics connection**..... 26
- On-board electronics**  
Two-way radios..... 388
- On-demand feature**..... 23
- Online services**..... 32
- Open Source Software, Free software**..... 34
- Opening the tailgate using your foot**  
HANDS-FREE ACCESS..... 73
- Opening the trunk lid using your foot**  
HANDS-FREE ACCESS..... 73
- Opening/closing a door**..... 151
- Opening/closing a garage door**..... 151
- Operating fluids**  
Additives..... 394  
Brake fluid..... 395  
Coolant..... 396  
Engine oil..... 394  
Gasoline..... 393  
Refrigerant (air conditioning system)..... 397  
Windshield washer fluid..... 396
- Operating safety**  
Declaration of conformity (wireless vehicle components)..... 26  
Information..... 24
- Operator's manual**..... 22
- Operator's Manual digital**..... 20
- Optimized acceleration**..... 132
- Outside mirrors**  
Automatic anti-glare mode..... 121  
Automatic mirror folding function..... 123  
Blind Spot Assist..... 181  
Folding in/out..... 120  
Memory function..... 99  
Setting..... 120
- Warning lamp..... 181
- Overhead control panel**  
Overview..... 14
- P**
- Paddle shifters**  
Steering wheel paddle shifters..... 143
- Paint code**..... 390
- Panic alarm, Alarm**  
Arming/disarming..... 64
- Park position**  
DIRECT SELECT lever..... 140  
Engaging..... 142
- Parking, PARKTRONIC**  
Electric parking brake..... 194
- Parking aid, Active Parking Assist, PARKTRONIC**..... 194
- Parking Assist, Active Parking Assist**..... 198
- Parking Assist PARKTRONIC**  
Activating..... 197  
Adjusting warning tones..... 198  
Function..... 194  
Side impact protection..... 196

- Switching off..... 197
- Parking assistance systems, PARKTRONIC**.... 194
- Parking brake, Electric parking brake**  
Electric..... 151
- Parking for an extended period**..... 154
- Parking lights**..... 112
- Parking position**  
Exterior mirrors..... 122  
Storing the position of the front-passenger outside mirror using reverse gear..... 123
- PARKTRONIC**  
Adjusting warning tones..... 198
- Payload**  
Calculation example..... 367  
Determining the maximum..... 366
- Permitted towing methods**..... 349
- Pets in the vehicle, Occupant safety**..... 62
- PIN protection**  
System PIN protection..... 240
- Playback options**  
Selecting..... 303
- POI**  
Selecting..... 250
- POI symbols**  
Selecting..... 267
- Point of resistance**  
Accelerator pedal..... 144
- Power supply**  
Start/stop button..... 128  
Switching on (start/stop button)..... 128
- Power washers**..... 329
- PRE-SAFE®**, Anticipatory occupant protection, Occupant safety, Preventative occupant protection system  
Function..... 50  
PRE-SAFE® Sound..... 50  
Reverting measures..... 50
- PRE-SAFE® PLUS**  
Function..... 50
- Previous destinations**  
Selecting..... 250
- Pulling away**  
Optimized acceleration..... 132
- Q**
- QR code rescue card**..... 30
- Qualified specialist workshop**..... 27
- R**
- Radar and ultrasonic sensors**..... 155
- Radio**  
Activating..... 311  
Activating/deactivating radio text..... 314  
Calling up the station list..... 313  
Deleting stations..... 313  
Direct frequency entry..... 313  
Displaying information..... 314  
Displaying radio text..... 314  
Managing favorites..... 313  
Managing station presets..... 313  
Moving stations..... 313  
Overview..... 312  
Setting a channel..... 313  
Setting the waveband..... 313  
Station search..... 313  
Storing radio stations..... 313  
Switching the HD Radio® function on/off..... 312



- Voice commands (Voice Control System)..... 218
- Radio equipment approval numbers**..... 389
- Rain closing function**
  - Sliding sunroof..... 81
- Rain sensor**
  - Sliding sunroof..... 81
  - Windshield wiper..... 118
- Reading lamp**
  - Interior lighting..... 117
- Rear fog light**..... 113
- Rear view camera**
  - 360° Camera..... 189
  - Care..... 332
  - Function..... 189
  - Opening the camera cover..... 194
  - Setting favorites (360° Camera)..... 194
- Rear window heater**..... 124
- Rearview mirror**
  - Automatic anti-glare mode..... 121
- Reflective safety vest**..... 336
- Refrigerant**..... 397
- Refueling**
  - Fuel..... 145
  - Refueling the vehicle..... 145
- Regulatory radio identification**
  - Indonesia..... 389
  - Israel..... 389
  - Small components..... 389
- Remote Online**
  - Charging the starter battery..... 130
  - Cooling/heating the vehicle interior..... 130
  - Starting the vehicle..... 131
- Removing/installing wheel trim**..... 381
- Replacement key, Duplicate key**..... 66
- Reporting safety defects**..... 29
- Reserve**
  - Fuel..... 394
- Resetting**
  - MBUX reset function..... 244
- Responsibility**
  - Driving safety systems..... 155
- Restraint system, Occupant safety**
  - Basic instructions for children..... 51
  - Function in the event of an accident..... 37
- Functionality..... 37
- Limited protection..... 36
- Malfunction..... 37
- Protection..... 36
- Self-test..... 37
- Warning lamp..... 37
- Reverse gear**
  - DIRECT SELECT lever..... 140
  - Engaging..... 141
- Roadside Assistance (breakdown)**..... 24
- Roll away protection, HOLD function**..... 159
- Roller sunblind**
  - Sliding sunroof..... 79
- Roof luggage rack**
  - Loading..... 106
  - Securing..... 106
- Route**
  - Alternative route..... 256
  - Calculating..... 254
  - Displaying destination information..... 256
  - Planning..... 251
  - Selecting a type..... 254
  - Selecting notifications..... 256
  - Selecting options..... 255

- Starting the automatic service station search..... 257
  - Switching the automatic gas station search on/off..... 256
  - Using automatic gas station search..... 256
  - With intermediate destinations..... 252
  - Route guidance**
    - Canceling..... 261
    - Changing direction..... 258
    - Destination reached..... 259
    - From an off-road location..... 261
    - Lane recommendations..... 259
    - Notes..... 257
    - Off-road..... 261
    - To an off-road destination..... 261
  - Route-based speed adaptation**
    - DISTRONIC..... 169
  - Route-based speed adjustment**
    - Setting..... 170
  - Run-flat characteristics, MOExtended tires...** 338
- S**
- Safety systems**
    - Overview..... 156
  - Satellite map**..... 271
  - Satellite radio**
    - Activating/deactivating TuneStart™..... 317
    - Adding a channel to Smart Favorites..... 317
    - Deleting a channel..... 316
    - Displaying EPG information..... 316
    - Displaying service information..... 317
    - Information..... 314
    - Information about Smart Favorites and TuneStart..... 317
    - Logging in..... 314
    - Moving a channel..... 316
    - Music and sport alerts function..... 316
    - Overview..... 315
    - Pause and playback function..... 317
    - Restrictions..... 314
    - Selecting a category..... 315
    - Selecting a channel..... 316
    - Setting music and sport alerts..... 316
    - Setting the parental control..... 316
    - Storing a channel..... 316
    - Switching on..... 314
  - SD card**
    - Inserting/removing..... 300
  - Seat**
    - Adjusting electrically..... 89
    - Configuring settings..... 92
    - Correct driver's seat position..... 86
    - Folding back the backrest (rear passenger compartment)..... 103
    - Folding the backrest forwards/back (with memory function)..... 92
    - Folding the backrest forwards/backwards (without memory function)..... 93
    - Locking the backrest (rear passenger compartment)..... 104
    - Lumbar support..... 90
    - Manual and electrical adjustment..... 87
    - Memory function..... 99
    - Resetting the settings..... 92
    - Settings..... 16
  - Seat belt**
    - Automatic tightening..... 42
    - Care..... 333
    - Fastening..... 41
    - Protection..... 38
    - Releasing..... 42
    - Warning lamp..... 42

- Seat belt adjustment**
  - Activating/deactivating..... 42
  - Function..... 42
- Seat belt extender**..... 41
- Seat belt warning**..... 42
- Seat belts**
  - Activating/deactivating seat belt adjustment..... 42
  - Reduced protection..... 39
  - Seat belt extender..... 41
- Seat heating**..... 94
- Seat height**..... 89
- Seat ventilation**..... 94
- Seats**, Back seat, Rear seat, Through-loading feature
  - Folding the backrest forwards (rear passenger compartment)..... 102
- Second telephone**
  - Connecting..... 275
  - Features..... 275
- Selecting a gear**..... 143
- Selector lever**, DIRECT SELECT lever..... 140
- Self-test**
  - Automatic front passenger airbag shut off..... 47
- Sensors**..... 332
- Service center**..... 27
- Service interval display, ASSYST PLUS**..... 321
- Service station search**
  - Starting automatic search..... 257
- Service, ASSYST PLUS**..... 321
- Setting a speed**..... 162
- Setting summer time**..... 235
- Setting the date format**..... 235
- Setting the distance unit**..... 240
- Shifting**
  - Automatic transmission..... 143
  - Gearshift recommendation..... 143
  - Manual..... 143
  - Steering wheel paddle shifters..... 143
- Shortening the braking distance**
  - BAS..... 157
- Side airbag**..... 43
- Side impact protection**..... 196
- Side windows**
  - Convenience closing..... 77
  - Convenience opening..... 77
  - Opening with the SmartKey..... 77
  - Opening/closing..... 75
  - Opening/closing with the SmartKey..... 77
  - Problem..... 78
- Size designation**
  - Tires..... 372
- Skid chains**..... 358
- Sliding sunroof**
  - Automatic functions..... 81
  - Closing..... 79
  - Closing with the SmartKey..... 77
  - Opening..... 79
  - Opening with the SmartKey..... 77
  - Problem..... 82
  - Rain closing function..... 81
- SmartKey**
  - Battery..... 65
  - Deactivating a function..... 64
  - Function..... 63
  - Key ring attachment..... 65
  - Mechanical key..... 65

- Panic alarm..... 64
- Power consumption..... 64
- Problem..... 66
- Unlocking setting..... 64
- Snow chains**..... 358
- Socket**
  - 12 V (front center console)..... 108
  - 12 V (trunk/cargo compartment)..... 108
- Software update**
  - Performing..... 243
  - Software updates..... 242
  - System updates..... 243
- Sound**
  - PRE-SAFE® Sound..... 50
  - Wheels/tires..... 357
- Sound settings**
  - Adjusting treble, mid-range and bass settings..... 318
  - Automatic volume adjustment..... 318
  - Calls up the sound menu..... 318
  - Information..... 318
  - Setting the balance and fader..... 318
- Spare parts, Mercedes-Benz GenuineParts**..... 21
- Spare wheel**
  - Emergency spare wheel..... 386
- Special seat belt retractor**..... 55
- Specialist workshop**..... 27
- Speed**
  - Storing, cruise control..... 167
  - Storing, DISTRONIC..... 167
  - Storing, limiter..... 167
- Speed rating**
  - Tires..... 372
- Standing lights**..... 112
- Start-off assist, Optimized acceleration**..... 132
- Start/stop button**
  - Parking the vehicle..... 147
  - Starting the vehicle..... 129
  - Switching on the power supply/vehicle.. 128
- Start/stop function, ECO start/stop function**..... 136
- Starter battery**
  - charging, Remote Online..... 130
- Starting**
  - Remote Online..... 131
  - Start/stop button..... 129
- Starting assistance**..... 347
- Starting the engine**
  - Emergency operation mode..... 130
  - Remote Online..... 131
  - Start/stop button..... 129
- Starting-off aid**
  - Hill start assist..... 160
  - Optimized acceleration..... 132
- Station**
  - Deleting..... 313
  - Direct frequency entry..... 313
  - Moving..... 313
  - Setting..... 313
  - Storing..... 313
- Station list**
  - Calling up..... 313
- Station presets**
  - Managing..... 313
- Station search**..... 313
- Steer Assist, STEER CONTROL**..... 159
- STEER CONTROL, Steer Assist**..... 159
- Steering wheel**
  - Adjusting electrically..... 96

- Buttons..... 207
  - Manually adjusting..... 95
  - Memory function..... 99
  - Steering wheel heater..... 96
  - Steering wheel adjustments**..... 96
  - Steering wheel heater**..... 96
  - Steering wheel paddle shifters**..... 143
  - Steering-wheel buttons**
    - Overview..... 211
  - Stop and go**
    - ECO start/stop function..... 137
  - Stopping**
    - Parking the vehicle..... 147
  - Stowage spaces**
    - Armrest..... 102
    - Center console (front)..... 102
    - Door..... 102
    - Glove box..... 102
  - Substances hazardous to health**..... 24
  - Sulfur content**..... 393
  - Surround lighting, Locator lighting**
    - Setting..... 117
  - Surround view camera**
    - Care..... 332
  - Suspension, AIRMATIC**
    - AIRMATIC..... 188
    - Damping characteristics..... 187
    - DYNAMIC BODY CONTROL..... 187
  - Suspension level**
    - AIRMATIC..... 188
  - Switch-off delay time**
    - From outside..... 117
    - Interior..... 118
  - Switching air-recirculation mode on/off**..... 125
  - Switching loudness normalization on/off**
    - Advanced sound system..... 320
  - Switching the surround sound on/off**
    - Burmester® surround sound system..... 319
  - Synchronization function**
    - Activating/deactivating (control panel)... 125
  - System PIN protection**
    - Activating/deactivating..... 240
  - System settings**
    - Activating/deactivating system PIN protection..... 240
  - MBUX reset function..... 244
  - Setting the distance unit..... 240
  - Setting the time and date automatically..... 234
  - Setting the time zone..... 235
  - Setting the time/date format..... 235
  - Transmission of the vehicle position..... 235
- T**
- Tailpipes**
    - Care..... 332
  - Tank content**
    - Fuel..... 394
    - Reserve..... 394
  - Technical data**
    - Component-specific information..... 390
    - Information..... 388
    - Regulatory radio identification..... 389
    - Regulatory radio identification - Indonesia and Israel..... 389
    - Vehicle dimensions..... 398
  - Telephone**
    - Activating functions during a call..... 278
    - Call and ringtone volume..... 277

- Calls with several participants..... 278  
Charging wirelessly (mobile phone)..... 110  
Connecting a mobile phone (Near Field Communication (NFC))..... 276  
Connecting a mobile phone (Passkey).... 274  
Connecting a mobile phone (Secure Simple Pairing)..... 274  
De-authorizing a mobile phone..... 276  
Disconnecting a mobile phone..... 276  
Importing contacts..... 280  
Importing contacts (overview)..... 280  
Incoming call during an existing call..... 278  
Information..... 274  
Interchanging mobile phones..... 275  
Mobile phone voice recognition..... 277  
Notes..... 271  
Notes on wireless charging (mobile phone)..... 108  
Operating modes..... 274  
Reception and transmission volume..... 277  
Switching mobile phones (Near Field Communication (NFC))..... 276  
Telephone menu overview..... 273  
Telephone operation..... 278  
Using Near Field Communication (NFC)..... 276
- Voice commands (Voice Control System)..... 218
- Telephony operating modes**  
Bluetooth® Telephony..... 274
- Temperature**  
Setting the vehicle interior temperature..... 124
- Temperature grade**..... 369
- Text messages**  
Calling a message sender..... 283  
Changing folders..... 283  
Composing..... 282  
Configuring the displayed text messages..... 281  
Deleting..... 283  
Drafts..... 283  
Notes..... 281  
Options..... 283  
Outbox..... 283  
Read-aloud function..... 282  
Reading..... 282  
Replying..... 282  
Sending..... 282
- Voice commands (Voice Control System)..... 221
- Time**  
Manual time setting..... 235  
Setting summer time..... 235  
Setting the time and date automatically..... 234  
Setting the time zone..... 235  
Setting the time/date format..... 235
- TIN (Tire Identification Number)**..... 370
- Tire and Loading Information placard**..... 365
- Tire characteristics**..... 372
- Tire information table**..... 365
- Tire labeling**  
Characteristics..... 372  
DOT, Tire Identification Number (TIN).... 370  
Load index..... 372  
Load-bearing capacity..... 372  
Maximum tire load..... 371  
Maximum tire pressure..... 371  
Size designation..... 372  
Speed rating..... 372  
Temperature grade..... 369  
Tire Quality Grading..... 369



















- Traction grade..... 369
- Tread wear grade..... 369
- Tire pressure**
- Checking..... 362
- Checking manually..... 361
- Maximum..... 371
- Restarting the tire pressure loss warning system..... 364
- Tire pressure loss warning system, function..... 363
- Tire pressure table..... 360
- TIREFIT kit..... 339
- Tire pressure loss warning system**
- Function..... 363
- Restarting..... 364
- Tire pressure monitor**
- Function..... 361
- Tire pressure monitoring system**
- Restarting..... 363
- Tire pressure table**..... 360
- Tire Quality Grading**..... 369
- Tire sealant**..... 339
- Tire tread**..... 357
- Tire-change tool**..... 380
- Tire-change tool kit**
- Overview..... 380
- TIREFIT kit, Tire inflation compressor**
- Storage location..... 339
- Tires**
- Breakdown..... 337
- Characteristics..... 372
- Checking..... 357
- Checking the temperature..... 362
- Checking the tire pressure manually..... 361
- Definitions..... 374
- DOT, Tire Identification Number (TIN)..... 370
- Installing..... 384
- Labeling..... 369
- Load index..... 372
- Load-bearing capacity..... 372
- Maximum pressure..... 371
- Maximum tire load..... 371
- MOExtended..... 338
- Noise..... 357
- Notes on installing..... 376
- Removing..... 384
- Removing/installing hub cap..... 381
- Removing/installing wheel trim..... 381
- Replacing..... 376, 380
- Restarting the tire pressure loss warning system..... 364
- Rotating..... 379
- Selection..... 376
- Size designation..... 372
- Snow chains..... 358
- Speed rating..... 372
- Storing..... 380
- Temperature grade..... 369
- Tire and Loading Information placard..... 365
- Tire pressure loss warning system, function..... 363
- Tire pressure table..... 360
- Tire Quality Grading..... 369
- TIREFIT kit..... 339
- Traction grade..... 369
- Tread wear grade..... 369
- Unusual handling characteristics..... 357
- Top Tether**..... 58
- Touch Control**
- MBUX..... 226
- On-board computer..... 207
- Setting the sensitivity..... 226

- Touchpad**  
Activating/deactivating haptic operation feedback..... 228  
Operating..... 227  
Reading the handwriting recognition aloud..... 228  
Selecting a station and track..... 228  
Setting the sensitivity..... 228  
Switching on/off..... 227
- Tow bar system**  
Towing away..... 203
- Tow-away protection**..... 84
- Tow-starting**..... 353
- Towing**  
Towing methods..... 349
- Towing away**..... 350
- Towing eye**..... 353
- Towing methods**..... 349
- Track**  
Selecting (audio mode)..... 303
- Traction grade**..... 369
- Traffic information**  
Displaying the traffic map..... 264  
Displaying traffic incidents..... 264  
Extending a Live Traffic Information subscription..... 263  
Issuing hazard warnings..... 265  
Live Traffic Information..... 263  
Overview..... 263
- Traffic light warning/display**..... 180
- Traffic Sign Assist**  
Function..... 180  
Setting..... 181
- Trailer drawbar, Pulling/towing, Tow bar system**..... 203
- Transferred vehicle data**  
Android Auto..... 287  
Apple CarPlay®..... 287
- Transmission**  
Automatic transmission (problem)..... 142  
Engaging drive position..... 142  
Engaging neutral..... 141  
Engaging reverse gear..... 141  
Selecting park position..... 142
- Transmission position display**..... 140
- Transmission positions**  
DIRECT SELECT lever..... 140
- Transporting**  
Vehicle..... 351
- Tread wear grade**..... 369
- Trunk lid**  
Activating/deactivating the tailgate opening height restriction..... 75  
Closing..... 71  
Emergency release (from inside)..... 75  
HANDS-FREE ACCESS..... 73  
Opening/closing..... 70  
Switching the separate locking feature on/off..... 74
- Tuneln**  
Logging out..... 298  
Registering..... 298  
Selecting stream..... 298  
Setting options..... 298
- Tuneln, Internet radio**  
Calling up..... 297  
Deleting stations..... 298  
Overview..... 297  
Saving stations..... 298



- Selecting and connecting a station..... 298
  - Turn signal indicator**..... 113
  - Turn signal light**..... 113
  - Two-way radios**
    - Frequencies..... 389
    - Installation..... 388
    - Transmission output..... 389
- U**
- Unfastening**..... 42
  - Units of measurement**
    - Setting..... 240
  - Unlocking setting**..... 64
  - Updates**
    - Information..... 242
    - Performing..... 243
    - Software updates..... 243
    - System updates..... 243
  - USB devices**
    - Connecting..... 302
  - USB port**
    - Front..... 102
- User profile**
- Creating..... 242
  - Importing/exporting..... 242
  - Options..... 242
  - Setting..... 241
- V**
- Vehicle**
- Activating, Remote Online..... 131
  - Activating/deactivating standby mode... 154
  - Automatic locking..... 69
  - Collision detection..... 153
  - Correct use..... 28
  - Data storage..... 30
  - Diagnostics connection..... 26
  - Emergency key..... 69
  - Equipment..... 22
  - KEYLESS-GO..... 67
  - Limited Warranty..... 30
  - Locking/unlocking (from inside)..... 67
  - Locking/unlocking emergency key..... 69
  - Lowering..... 385
  - Maintenance..... 24
  - Medical aids..... 28
  - Parking for an extended period..... 154
  - Problem notification..... 28
  - Pulling..... 203
  - QR code rescue card..... 30
  - Raising..... 382
  - Standby mode function..... 154
  - Starting (start/stop button)..... 129
  - starting, emergency operation mode..... 130
  - Switching off, start/stop button..... 147
  - Switching on, start/stop button..... 128
  - Transporting..... 351
  - ventilating / convenience opening..... 77
  - Voice commands for the Voice Control System..... 222
- Vehicle camera**
- Information..... 155
- Vehicle data**
- Display, MBUX..... 140
  - Displaying, DYNAMIC SELECT..... 140
  - Maximum speeds..... 399
  - Transferring to Android Auto..... 287
  - Transferring to Apple CarPlay®..... 287
  - Turning circle..... 398
  - Vehicle height..... 398
  - Vehicle length..... 398
  - Vehicle width..... 398

- Weights..... 399  
 Wheelbase..... 398
- Vehicle dimensions**..... 398
- Vehicle emergency start**..... 353
- Vehicle equipment**..... 22
- Vehicle identification number, VIN**..... 390
- Vehicle identification plate**  
 Model type..... 390  
 Paint code..... 390  
 VIN..... 390
- Vehicle interior**  
 Cooling/heating (Remote Online)..... 130
- Vehicle key**..... 63
- Vehicle location**  
 Switching transmission on/off..... 235
- Vehicle operation outside the USA or Canada**..... 23
- Vehicle sensors**..... 155
- Vehicle start**  
 Emergency operation mode..... 130  
 Remote Online..... 131  
 Start/stop button..... 129
- Vehicle tool kit**  
 TIREFIT kit..... 339  
 Towing eye..... 353
- Ventilating, Convenience opening**..... 77
- Ventilation**..... 127
- Vents**..... 127
- Video mode**  
 Activating..... 303  
 Activating/deactivating full-screen mode..... 305  
 Overview..... 305  
 Settings..... 306
- VIN, Vehicle identification number**  
 Engine compartment..... 390  
 Identification plate..... 390  
 Seat..... 390
- Vision**  
 Removing condensation from the windows..... 125
- Voice command types (Voice Control System)**..... 212
- Voice Control System**  
 Application specific voice commands..... 212
- Audible help functions..... 212  
 Global voice commands..... 212  
 Improving voice quality..... 212  
 Language setting..... 212  
 Media player voice commands..... 219  
 Message voice commands..... 221  
 Multifunction steering wheel (operation)..... 211  
 Navigation voice commands..... 214  
 Operable functions..... 212  
 Operating safety..... 211  
 Radio voice commands..... 218  
 Switch voice commands..... 213  
 Telephone voice controls..... 218  
 Text message voice commands..... 221  
 Types of voice commands..... 212  
 Vehicle voice commands..... 222  
 Voice prompting..... 211
- W**
- Warning system, ATA**..... 83
- Warning triangle**..... 336, 337
- Warning/indicator lamp**  
 ABS warning lamp..... 462

 Brake system warning lamp (Canada only).....	460
 Brake warning lamp (USA only).....	460
 Brakes warning lamp (yellow) (Canada only).....	459
 Coolant warning lamp.....	454
 Electric parking brake indicator lamp (red) (Canada only).....	458
 Electric parking brake indicator lamp (red) (USA only).....	458
 Electrical malfunction warning lamp.....	456
 Engine diagnosis warning lamp.....	456
 ESP® OFF warning lamp.....	463
 ESP® warning lamp.....	462
 Fuel reserve warning lamp.....	456
 Power steering warning lamp (red).....	453
 Recuperative Brake System warning lamp (USA only).....	459
 Restraint system warning lamp.....	452
 Seat belt warning lamp.....	452
 Suspension warning lamp (yel- low).....	461
 The electric parking brake (yel- low) indicator lamp.....	458
 Tire pressure monitoring system warning lamp.....	464
 Warning lamp for distance warning function.....	461
<b>Warning/indicator lamps</b>	
Instrument display.....	450
PASSENGER AIR BAG.....	47
<b>Washer fluid</b>	
Windshield washer fluid.....	396
<b>Washing by hand</b> .....	
330	
<b>Water tank</b> .....	
328	
<b>Weather information</b> .....	
271	
<b>Wedge</b> .....	
380	
<b>Weight information</b> .....	
390	

**what3words**

Destination entry with a 3 word address.....	252
---	-----

**Wheel change**

Installing a new wheel.....	384
Lowering the vehicle.....	385
Removing/installing hub caps.....	381

**Wheel rotation**..... 379**Wheels**

Breakdown.....	337
Care.....	332
Checking.....	357
Checking the tire pressure manually.....	361
Checking the tire temperature.....	362
Definitions.....	374
DOT, Tire Identification Number (TIN).....	370
Installing.....	384
Load index.....	372
Load-bearing capacity.....	372
Maximum tire load.....	371
Maximum tire pressure.....	371
MOExtended.....	338
Noise.....	357
Notes on installing.....	376
Removing.....	384

- Removing/installing hub cap..... 381
- Removing/installing wheel trim..... 381
- Replacing..... 376, 380
- Rotating..... 379
- Selection..... 376
- Size designation..... 372
- Snow chains..... 358
- Speed rating..... 372
- Storing..... 380
- Temperature grade..... 369
- Tire and Loading Information placard..... 365
- Tire characteristics..... 372
- Tire labeling..... 369
- Tire pressure..... 358
- Tire pressure monitor..... 361
- Tire Quality Grading..... 369
- TIREFIT kit..... 339
- Traction grade..... 369
- Tread wear grade..... 369
- Unusual handling characteristics..... 357
- Wi-Fi, System settings, Wi-Fi**
  - Overview..... 236
  - Setting..... 236
  - Setting up a hotspot..... 237
- Widescreen cockpit instrument display**
  - Instrument cluster..... 12
- Window curtain airbag**..... 43
- Windows**
  - Care..... 332
  - Defrosting..... 125
  - Opening/closing..... 75
- Windshield, Windshield**
  - Defrosting..... 124
  - Replacing the wiper blades..... 118
- Windshield washer fluid**..... 396
- Windshield washer system**..... 327
- Windshield wiper**
  - Activating/deactivating..... 118
- Windshield wipers**
  - Replacing the wiper blades..... 118
- Winter operation**
  - Snow chains..... 358
- Wiper blades**
  - Care..... 332
  - Replacing (windshield)..... 118
- Wipers**
  - Windshield wiper..... 118
- Wireless charging**
  - Mobile phone..... 110
  - Overview..... 108
- Wireless vehicle components**
  - Declaration of conformity..... 26
- Workshop**..... 27



