



1675844527

Order no. P167 0785 13 Part no. 167 584 45 27
Edition A 2024



GLE

Mercedes-AMG Supplement

Mercedes-Benz



Publication details

Internet

Further information about Mercedes-Benz vehicles and about Mercedes-Benz AG can be found on the following websites:

<https://www.mbusa.com> (USA only)

<https://www.mercedes-benz.ca> (Canada only)

Documentation team

©Mercedes-Benz AG: Not to be reprinted, translated or otherwise reproduced, in whole or in part, without written permission from Mercedes-Benz AG.

Vehicle manufacturer

Mercedes-Benz AG

Mercedesstraße 120

70372 Stuttgart

Germany

As at 26.09.22

Thank you for purchasing a Mercedes-AMG

Before your first drive, please read this Operator's Manual carefully and familiarize yourself with your vehicle. For your own safety and a longer service life of the vehicle, follow the instructions and warning notices in this Operator's Manual. Disregarding them may lead to damage to the vehicle or injury to people.

Damage to the vehicle resulting from the disregard of the instructions is not covered by the Mercedes-Benz Limited warranty.

The standard equipment and product description of your vehicle may vary and depends on the following factors:

- Model
- Order
- National version
- Availability

Your vehicle may therefore differ from that shown in the descriptions and illustrations in individual cases.

Mercedes-AMG reserves the right to introduce changes in the following areas:

- Design
- Equipment
- Technical features

The following documents are integral parts of the vehicle:

- Digital operator's manual
- Printed Operator's Manual
- Maintenance Booklet
- Supplementary manuals relating to specific equipment
- Supplementary documents

Keep these documents in the vehicle at all times. Ensure that all documents are in the vehicle or passed on in the event of sale or rental.

Mercedes-Benz USA, LLC

Mercedes-Benz Canada, Inc.

A Mercedes-Benz Group AG Company

1675844527



Symbols 3

At a glance 4

Cockpit 4

General notes 6

Operator's Manual 6

Driving and parking 7

Driving 7

DYNAMIC SELECT 10

Automatic transmission 13

Driving and driving safety systems 15

Driver's display 23

Notes on the driver's display 23

Operating the driver's display 23

Driver display menus 24

Function of the head-up display 29

Overview of status displays on the driver's display (Mercedes-AMG vehicles) 30

MBUX multimedia system 31

AMG TRACK PACE 31

Maintenance and care 36

Notes on the care of tailpipes 36

Wheels and tires 37

Changing a wheel 37

Technical data 38

Operating fluids 38

Vehicle data 41

Trailer hitch 45

Display messages and warning/indicator

lamps 47

Display messages 47

Warning and indicator lamps 48

Index 50

In this Operator's Manual, you will find the following symbols:

⚠ WARNING Danger due to failure to observe the warning notices

Warning notices draw your attention to hazards that may endanger your health or life, or the health or life of others.

▶ Observe the warning notices.

🌿 ENVIRONMENTAL NOTE Environmental damage due to failure to observe environmental notes

Environmental notes include information on environmentally responsible behavior or environmentally responsible disposal.

▶ Observe environmental notes.

! NOTE Damage to property due to failure to observe notes on material damage

Notes on material damage inform you of risks which may lead to your vehicle being damaged.

▶ Observe notes on material damage.

ⓘ These symbols indicate useful instructions or further information that could be helpful to you.

▶ Instruction

(→ page) Further information on a topic

Display Display in the central display

↪ Highest menu level, which is to be selected in the multimedia system

▶▶ Relevant submenus, which are to be selected in the multimedia system

* Indicates a cause

4 At a glance – Cockpit

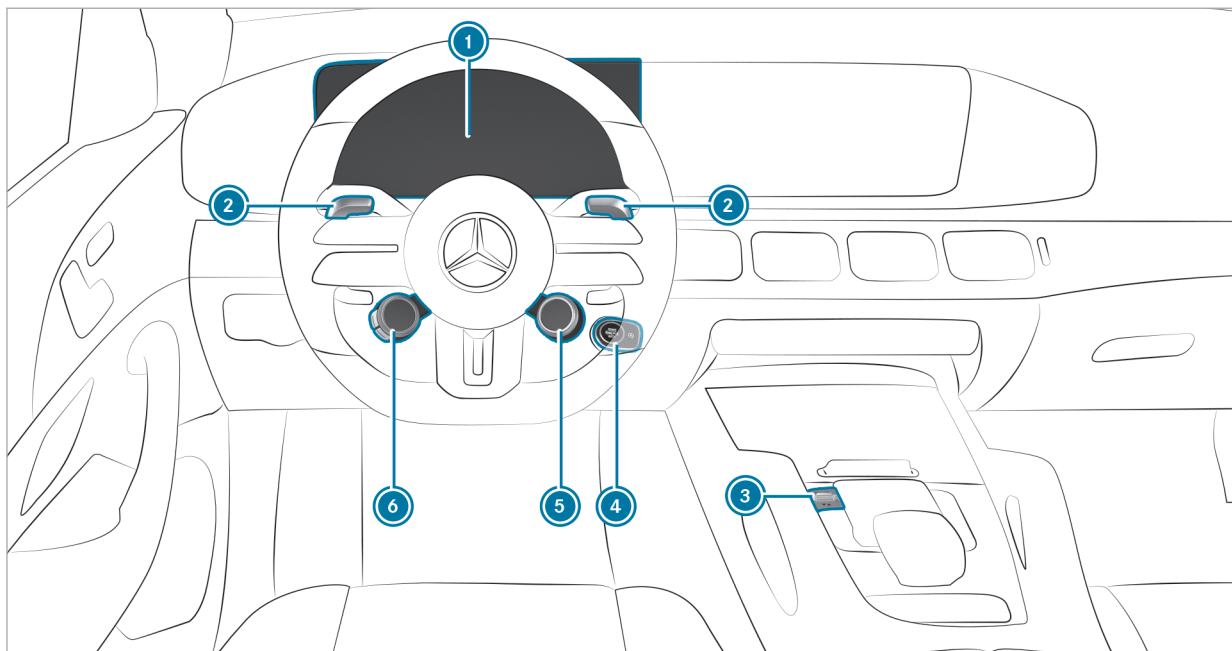

Left-hand drive vehicles

① Driver's display			④ Start/stop button	→	8
② Steering wheel paddle shifters	→	13	⑤ Selects the drive program	→	11
③ DYNAMIC SELECT switch	→	10	⑥ AMG steering-wheel buttons	→	7

Operator's Manual

These Operating Instructions provide information on all the important functions of your AMG vehicle that are either not described or differ from the descriptions in the Operator's Manual. This information supplements or replaces the corresponding sections in the vehicle Operator's Manual.

Under no circumstances do the Operating Instructions replace the printed vehicle Operator's Manual and the Digital Operator's Manual in the vehicle.

This Supplement and the Digital Operator's Manual in the vehicle describe the following models, standard and special equipment of your vehicle:

- Models, standard and special equipment available at the time of going to press with these Operating Instructions.
- The models and the standard and special equipment only available in certain countries.
- The models and the standard and special equipment, which will only be available at a later date.

Note that your vehicle may not be installed with all features described. This is also the case for systems relevant to safety. Therefore, the equipment on your vehicle may differ from that in the descriptions and illustrations.

The original purchase agreement for your vehicle contains a list of the equipment in your vehicle at the time of delivery.

Should you have any questions concerning equipment and operation, please consult an authorized Mercedes-Benz Center.

The Operator's Manual, Operating Instructions, further supplementary documents and Maintenance Booklet are important documents and should be kept in the vehicle.

Driving

Engine output and engine torque (Mercedes-AMG vehicles)

i The actual (maximum) values that can be achieved for engine output and engine torque may deviate from the certified values within the permissible tolerances according to country-specific guidelines (basis: UN-ECE No. 85 or country-specific guidelines).

Variables that can influence this are, for example:

- Location above sea level
- Fuel quality
- Outside temperature
- Operating temperature of the engine

Until the engine has reached its operating temperature, the engine operating temperature warning lamp  is lit.

Engine output and engine torque have been reduced. Take this into account in your driving style.

When the engine operating temperature warning lamp  goes out, full engine output and engine torque are available to you.

Function of the AMG steering-wheel buttons

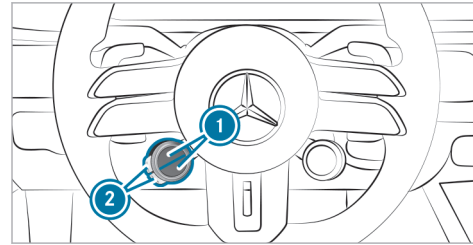







The AMG steering-wheel buttons are an additional control element with two buttons on the steering wheel.

You can assign two vehicle functions of your choice to the control element. You can change between the available functions for the corresponding button **2** by pressing the upper or lower part of the display button **1** repeatedly.

The display buttons **1** show each function selected.

Depending on the vehicle's equipment, the following functions will be available:

-  ESP® (→ page 15)
-  AMG RIDE CONTROL + (→ page 18)
AMG ACTIVE RIDE CONTROL (→ page 19)
-  Manual gearshifting (→ page 13)
-  ECO start/stop function (→ page 9)
-  AMG Real Performance Sound (→ page 9)
-  Camera views (see the vehicle Operator's Manual)
-  AMG DYNAMICS (→ page 10)

You can also select all functions that you have set as favorites in the multimedia system. Information on favorites in the multimedia system and their configuration (see vehicle Operator's Manual).

- ① Individual functions may not be shown. How functions are displayed and the order in which they are displayed can be set in the multimedia system (→ page 8).

If you have assigned a function to one of the display buttons ①, you can operate this function with the corresponding button ②.

The assignment of the display buttons ① remains stored even after the vehicle is started again. The operating status of the respective function is, however, reset to the basic setting.

Setting the AMG steering wheel buttons

Multimedia system:

-  >> Settings >> System
- >> Control Elements
- >> AMG Steer. Wheel Buttons

- ① The **SETTINGS SELECT** menu can also be called up using the **DYNAMIC SELECT** button or by a long press on the respective display button.

The left display buttons on the steering wheel can be set in the **SETTINGS SELECT** menu.

- ▶ In the media display, select the upper or lower display button and switch to the editing mode by means of a long press.
- ▶ Press  and select the desired function from the list.
The selected function is assigned to the corresponding display button and can now be called up directly by simply pressing it.

Deleting button assignment

- ▶ Select the upper or lower display button and switch to editing mode by pressing and holding it.
- ▶ Press  to delete the selected display button assignment.

Function of the Emotion Start (Mercedes-AMG vehicles)

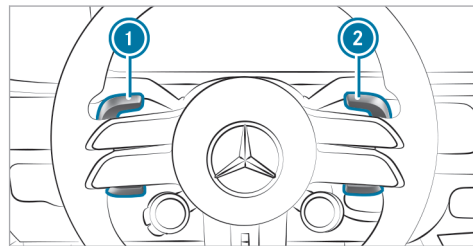

- ▶ Start the vehicle with the start/stop button and simultaneously pull one of steering wheel paddle shifters ① or ②.
The idle speed is briefly increased upon starting and the engine sound is reproduced in a sporty and powerful manner.

Follow the instructions for starting the vehicle in the Operator's Manual for the vehicle.

Switching the ECO start/stop function on or off using the steering wheel button (Mercedes-AMG vehicles)

Observe the notes on the ECO start/stop function in the vehicle Operator's Manual.

- i** You can also switch the ECO start/stop function on or off via the multimedia system.

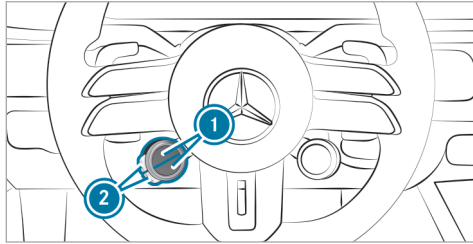

- ▶ Press upper or lower display button **1** repeatedly, until it displays the **[A]** symbol.
- i** If the display button does not show the symbol, then it is hidden. How functions are displayed and the order in which they are displayed

played can be set in the multimedia system (→ page 8).

- ▶ Press corresponding button **2**.

The symbol indicates the current status of the ECO start/stop function:

- **[A^{OFF}]** (red): deactivated
- **[A]** (green): activated
- **[A]** (yellow): inactive

AMG Real Performance Sound

■ Selecting a sound characteristic with the steering-wheel button

- i** You can select a comfortable (Balanced) or a sporty (Powerful) sound characteristic using the steering-wheel button or the multimedia system (→ page 13).

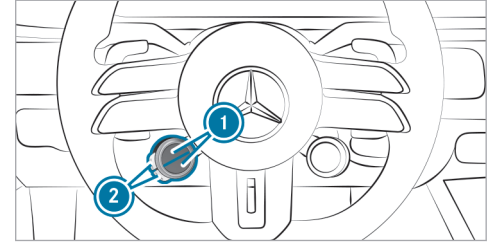

- ▶ Press upper or lower display button **1** repeatedly, until it displays the **[A]** symbol.
- i** If the display button does not show the symbol, then it is hidden. How functions are displayed and the order in which they are displayed can be set in the multimedia system (→ page 8).
- ▶ Press corresponding button **2**.
The color of the button symbol indicates the currently selected sound characteristic:
 - **Blue:** Balanced – comfortable
 - **Red:** Powerful – sporty

Information on the AMG ceramic high-performance composite brake system

The brake system is designed for heavy loads. This may lead to noise when braking. This effect can also occur after washing the vehicle.



The noise depends on the following factors:

- speed
 - brake force
 - environmental conditions, e.g. temperature and air humidity
- i** Have the brake system checked at a qualified specialist workshop after it has been subjected to extreme loads.





DYNAMIC SELECT



Function of DYNAMIC SELECT (Mercedes-AMG vehicles)

DYNAMIC SELECT makes the quick selection of an on-road or off-road drive program possible in accordance with the current driving situation or the desired vehicle characteristics.



i Depending on the engine and equipment, the vehicle has different drive programs. The display and the drive programs available depend on the on-road  or the off-road  setting in the DYNAMIC SELECT menu of the multimedia system (→ page 13).

You can select from the following on-road  drive programs:

-  **Slippery**
 - Optimized pulling away and driving characteristics in wintry and slippery road conditions
-  **Comfort**
 - Comfortable and economical driving
 - Balance between traction and stability
-  **Individual**
 - Customized settings for drive, suspension, steering and ESP®
-  **Sport**
 - Sporty driving
 - Balance between stability and sportiness



- Suitable only for good road conditions, a dry surface and a clear stretch of road
-  **Sport+**
 - Particularly sporty driving
 - Emphasis on the vehicle's own understeering and oversteering characteristics
 - Suitable only for good road conditions, a dry surface and a clear stretch of road
-  **Race**
 - Maximum sportiness
 - Particularly firm suspension tuning of AMG RIDE CONTROL
 - Sporty sound from the exhaust system

i Drive program  is only available for the Mercedes-AMG GLE 63 S 4MATIC+ model.







Drive program  offers driving characteristics suited for the racetrack and must not be used on normal roads. Drive program  may be activated and used only on dedicated race circuits, not on public roads.

Mercedes-AMG recommends selecting drive program  when in city traffic or stop-and-go traffic.



If off-road  is selected in the DYNAMIC SELECT menu, you can select from the following off-road drive programs:

-  **Sand**
 - Improved traction due to late intervention if there is oversteer or understeer
 - Optimized driving characteristics for driving on sand
 - Not suitable for use on public roads
-  **Trail**
 - Improved traction due to late intervention if there is oversteer or understeer
 - Optimized driving characteristics for driving on less demanding off-road terrain with loose surfaces, for example, on dirt tracks or on gravel and sand
 - Not suitable for use on public roads

Depending on the on-road or off-road drive program selected, the following vehicle characteristics will change:



- Drive
- AMG DYNAMICS
 - The four agility functions, Basic, Advanced, Pro and Master, as well as the two agility functions, Slide and Traction for off-road programs, are selected automatically depending on the drive program.
 - The steering, shift timing point, all-wheel drive and stabilization functions will be adapted to the selected drive program.
 - When ESP® is activated, the Pro agility function will be selected in drive program . If ESP® is switched to SPORT  or deactivated , the Master function is selected automatically.
 - When ESP® is activated, the Basic agility function will be selected in drive programs  and . If ESP® is switched to SPORT  or deactivated , the

Slide and Traction functions are selected automatically.



- Real Performance Sound
 - Suspension
 - Steering
 - Availability of Glide mode
 - 4MATIC+ all-wheel drive
-  You can set the drive program characteristics using the DYNAMIC SELECT menu of the multimedia system (→ page 13).
-  You can adjust certain agility functions of AMG DYNAMICS using the AMG steering wheel buttons.

Selecting a drive program (Mercedes-AMG vehicles)

Selection with right-hand steering-wheel button

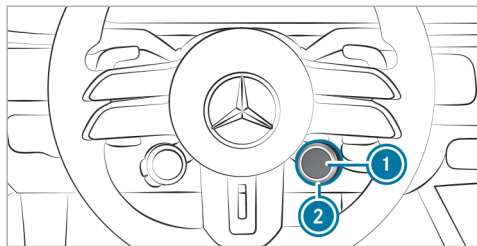
-  Depending on the setting in the DYNAMIC SELECT menu of the multimedia system, either the on-road  or the off-road  drive programs can be selected (→ page 13).





▶ Press display button ① and switch between the on-road  and the off-road  drive programs in the DYNAMIC SELECT menu as required.

▶ Turn rotary switch ②.



The selected drive program will appear on display button ① and on the driver's display.

① Individual drive programs may not be shown. How drive programs are displayed and the order in which they are displayed can be set in the multimedia system (→ page 13).

Making selections using the DYNAMIC SELECT switch

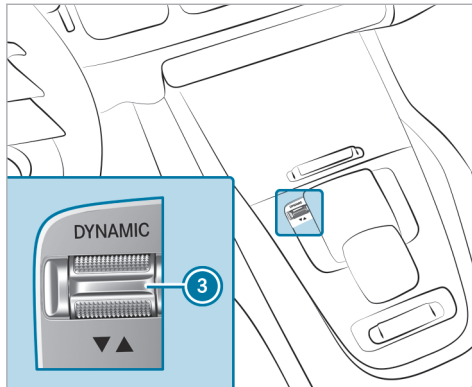
① Depending on the setting in the DYNAMIC SELECT menu of the multimedia system, either the on-road  or the off-road  drive programs can be selected (→ page 13).



▶ Switch between the on-road  and the off-road  drive programs in the DYNAMIC SELECT menu as required.

▶ Push DYNAMIC SELECT switch ③ forwards or backwards.

The selected drive program will appear on display button ① and on the driver's display.

Setting AMG DYNAMIC SELECT in the MBUX multimedia system



Multimedia system:

→  >> Settings >> Vehicle
>> DYNAMIC SELECT

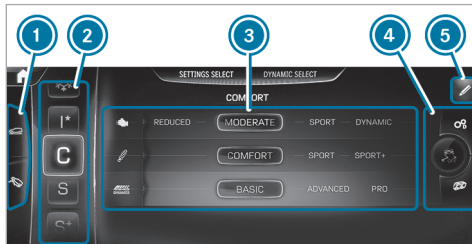
Overview of the AMG DYNAMIC SELECT menu



(Example representation) The representation and arrangement of content is equipment-dependent.

- ① Changes between the on-road  and off-road  drive programs.
- ② Drive programs

- ③ AMG drive program settings
 - ④ ESP and quick-access buttons® (→ page 15)
 - ⑤ Edits quick-access buttons
- ① The AMG DYNAMIC SELECT menu can also be called up using the DYNAMIC SELECT button.

▶ Select the appropriate drive program.

The settings of the drive programs can be adjusted individually.

▶ Select the desired tab on the left and make the relevant setting.

Setting options for the drive programs (equipment-dependent)

- AMG DYNAMICS:
Basic/Advanced/Pro/Master
- Suspension:
Comfort/Sport/Sport+
- Sound:
Balanced/Powerful

- Drive (can only be set in the  drive program):
Reduced/Moderate/Sport/Dynamic

Automatic transmission

Rocking the vehicle free

Rocking the vehicle free may help to free the vehicle if it has become stuck in slush or snow.

To rock the vehicle free, move the DIRECT SELECT lever upwards and downwards past the point of resistance to switch between transmission positions **D** and **R**.

- ① The maximum design speed for switching between **D** and **R** is approx. 6 mph (9 km/h).

Manual shifting (Mercedes-AMG vehicles)

- ① You can also activate and deactivate manual gearshifting via the multimedia system (→ page 14).

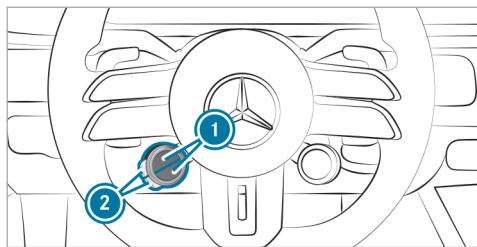



▶ Press upper or lower display button ① repeatedly, until it displays the  symbol.

① If the display button does not show the symbol, then it is hidden. How functions are displayed and the order in which they are displayed can be set in the multimedia system (→ page 8).

▶ **To activate/deactivate:** press corresponding button ②.

The symbol indicates the currently selected transmission position:

-  M (red): manual gearshifting
-  D (blue): automatic transmission

Shifting up and down

! **NOTE** Damage to the engine due to shifting up too late

The automatic transmission does not shift up in manual mode even when the engine's limiting speed is reached.

The fuel supply is interrupted in order to prevent the engine from overrevving.

▶ Shift up before the engine speed reaches the red area in the tachometer.

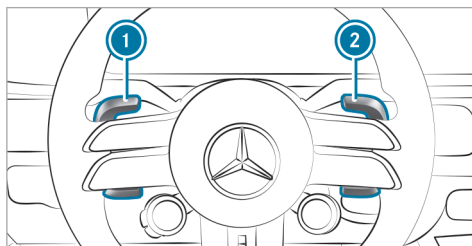

▶ **To shift up:** pull steering wheel paddle shifter ②.

▶ **To shift down:** pull steering wheel paddle shifter ①.

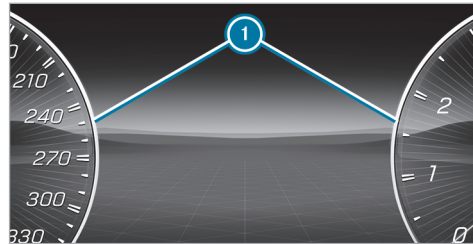

If the engine speed is too high or too low, you will not be able to change gear using the steering wheel paddle shifters. In this case, segments ① will light up red in the driver's display.

Permanently activating or deactivating manual gearshifting

Multimedia system:

   Settings  Vehicle  Driving

▶ Permanently switch the function on or off.

Function of Glide mode (Mercedes-AMG vehicles)

With an anticipatory driving style, Glide mode helps you to reduce fuel consumption.

When you drive in Glide mode, the  symbol will appear on the driver's display and the combustion engine is switched off. All of the vehicle functions remain active.

Glide mode will be activated if the following conditions are met:

- The ECO start/stop function is switched on.
- Drive program  is selected with the drive setting "Moderate" or "Reduced".
- The speed is within a suitable range.
- The road's course is suitable, e.g. no steep uphill or downhill gradients or tight bends.
- The state of charge of the battery is sufficient.
- You are no longer depressing the accelerator or brake pedal.

Glide mode will be deactivated again if one of the conditions is no longer met.

Driving and driving safety systems

Function of ESP® (Mercedes-AMG vehicles)

You can select between the following modes of the Electronic Stability Program (ESP®):

- ESP® ON
- ESP® SPORT
- ESP® OFF

Characteristics when ESP® is activated

ESP® monitors and improves driving stability and traction, particularly in the following situations:

- When pulling away on wet or slippery roads.
- When braking.
- **Vehicles with trailer hitch:** in trailer operation from speeds of 40 mph (65 km/h), if the vehicle/trailer combination begins to sway from side to side.
- When there is a strong crosswind and a driving speed of approximately 50 mph (80 km/h) to 125 mph (200 km/h).

ESP® can stabilize the vehicle by intervening in the following ways:

- One or more wheels are braked.
- The engine output is adapted according to the situation.

ESP® is activated every time the vehicle is started regardless of whether ESP® SPORT or ESP® OFF was selected before the vehicle was switched off.

When the  warning lamp flashes, one or several wheels has reached its grip limit:



- Adapt the driving style to suit the prevailing road and weather conditions.
- Do not deactivate ESP® under any circumstances.
- Depress the accelerator pedal only as far as necessary.

Characteristics of ESP® SPORT

⚠ WARNING Risk of skidding if ESP® SPORT is used incorrectly

When you activate ESP® SPORT, there is an increased risk of skidding and having an accident.

▶ Activate ESP® SPORT only in the circumstances described below.

When ESP® SPORT is selected, the  and  warning lamps light up continuously.

Select ESP® SPORT when the vehicle's own oversteering and understeering characteristics are desired, e.g. on cordoned-off roads.

Driving with ESP® SPORT or with ESP® deactivated requires an extremely qualified and experienced driver.

If ESP® SPORT is activated and one or more wheels start to spin, the  warning lamp will flash. ESP® then stabilizes the vehicle only to a limited degree.

ESP® SPORT also has the following characteristics:



- ESP® improves driving stability only to a limited degree.
- ETS/4ETS traction control is still active.
- The engine's torque is restricted only to a limited degree and the drive wheels can spin. The spinning of the wheels results in a cutting action for better traction on loose surfaces.
- ESP® continues to provide assistance when the brakes are firmly applied.
- **Vehicles with trailer hitch:** stabilization of the vehicle/trailer combination is no longer active.
- Crosswind Assist is no longer active.

Characteristics when ESP® is deactivated

⚠ WARNING Risk of skidding if ESP® is deactivated

If you deactivate ESP®, ESP® cannot carry out vehicle stabilization.

▶ ESP® should only be deactivated in the following situations.

When ESP® is deactivated, the  and  warning lamps light up continuously.

Deactivating ESP® has the following effects:

- Driving stability will no longer be improved.
 - The drive wheels could spin.
 - ETS/4ETS traction control is still active.
 - **Vehicles with trailer hitch:** stabilization of the vehicle/trailer combination is no longer active.
 - Crosswind Assist is no longer active.
- i** Even when ESP® is deactivated, you are still assisted by ESP® when braking hard.

It may be best to activate ESP® SPORT or deactivate ESP® in the following situations:

- When using snow chains.
- In deep snow.
- On sand or gravel.

- ❶ Spinning the wheels results in a cutting action, which enhances traction.
- ❷ Activate ESP® as soon as the situations described above no longer apply. ESP® will otherwise not be able to stabilize the vehicle if the vehicle starts to skid or a wheel starts to spin.

If the  warning lamp lights up continuously, ESP® is not available due to a malfunction.

Observe the display messages, warning lamps and indicator lamps that are shown.

- Indicator and warning lamps
- Display messages

ETS/4ETS (Electronic Traction System)

ETS/4ETS traction control is part of ESP®.

ETS/4ETS can improve the vehicle's traction by intervening in the following ways:

- The drive wheels are braked individually if they spin.
- More drive torque is transferred to the wheel or wheels with traction.

Setting ESP® with the steering-wheel button

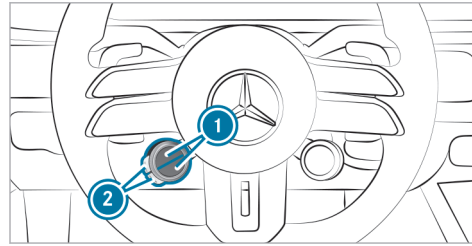

- ❶ You can also adjust ESP® via the multimedia system (→ page 18).



- ▶ **To set ESP®:** press upper or lower display button ❶ repeatedly, until it displays the  symbol.



- ❶ If the display button does not show the symbol, then it is hidden. How functions are displayed and the order in which they are displayed can be set in the multimedia system (→ page 8).



The color of the road in the  button symbol indicates the current setting:

-  (blue): ESP® ON
-  (yellow): ESP® SPORT
-  (red): ESP® OFF

- ▶ **To set ESP® SPORT:** briefly press button ❷ when ESP® is activated.



The road in the  button symbol will light up yellow.

The  and  warning lamps will appear on the driver's display.



- ❶ When you switch ESP® to SPORT  in drive programs  and , AMG Dynamics will automatically switch to the **Slide** or **Traction** level.

- ▶ **To deactivate ESP®:** select ESP® SPORT and then press and hold button ❷.

The road in the  button symbol will light up red.

The  and  warning lamps will appear on the driver's display.

- ① When you deactivate  ESP® in drive program , AMG Dynamics will automatically switch to the **Master** level.

If you deactivate  ESP® in drive programs  and , AMG Dynamics will automatically switch to the **Slide** or **Traction** level.

- ▶ **To activate ESP®:** briefly press button  when ESP® SPORT is selected or ESP® is deactivated.
The road in the  button symbol will light up blue.
The ,  or  warning lamps will go out.

If the  symbol is shown with a red ! on the display button, ESP® is malfunctioning. Observe the information on warning lamps and display messages which are shown on the driver's display.







Setting ESP® in the multimedia system





Multimedia system:

→  ▶ Settings ▶ Vehicle
▶ DYNAMIC SELECT

- ① The AMG **DYNAMIC SELECT** menu can also be called up using the **DYNAMIC SELECT** button.

ESP® will always be activated when the vehicle is started. The road in the  button symbol will light up blue.

- ▶ **To set ESP SPORT:** when ESP is activated, briefly press  to change to the **Sport** program.
The road in the  button symbol will light up yellow.
- ▶ **To deactivate ESP®:** set the ESP® SPORT program and press and hold  to deactivate ESP®.
The road in the  button symbol will light up red. The ,  and  warning lamps will appear on the driver's display.

- ▶ **To activate ESP :** briefly press  in ESP SPORT or if ESP is deactivated.
The road in the  button symbol will light up blue.
The ,  or  warning lamps will go out.

- ① You can also adjust ESP via the steering-wheel button (→ page 17).

AMG RIDE CONTROL +

Function of AMG RIDE CONTROL +

AMG RIDE CONTROL + is an air suspension system with variable damping for improved driving characteristics. The all-round level control system ensures the best possible suspension and constant ground clearance, even with a laden vehicle. When driving at speed, the vehicle is lowered automatically to improve driving safety and to reduce fuel consumption. You also have the option of manually adjusting the vehicle level.

The damping is set individually for each wheel and is affected by the following factors:



- The drive program selected

- Driving style, e.g. sporty
- Road condition, e.g. bumps
- The individual selection of **SPORT**, **SPORT +** or **COMFORT**

AMG RIDE CONTROL + includes the following components and functions:

- Air suspension with variable spring rate and automatic level control
- Speed-dependent lowering to reduce fuel consumption
- Manually selectable raised vehicle level for greater ground clearance
- Adaptive Damping System with constant damping force adjustment
- Rocker switch for suspension settings

Suspension setting and vehicle level per drive program

Drive programs  and :

- The suspension setting and the all-wheel drive 4MATIC+ are adapted for sporty performance on fine, loose surfaces (.



- The suspension setting and the all-wheel drive 4MATIC+ are adapted for driving in areas with no firm road surfaces (.
- The vehicle is set to the high level.
- When driving at speeds above 43 mph (70 km/h), the vehicle is lowered to the normal level.

Drive programs  and :

- The suspension setting is comfortable.
- The vehicle is set to the normal level.
- The vehicle is lowered to low level while you are driving in the following cases:
 - You are driving faster than 75 mph (120 km/h) for at least 20 seconds.
 - When driving faster than 87 mph (140 km/h).
- The vehicle is raised to the normal level again in the following cases:
 - You are driving slower than 75 mph (120 km/h) for at least one minute.
 - You are driving slower than 50 mph (80 km/h).

- 4MATIC+ is dynamically synchronized.

Drive programs ,  and :

- The suspension setting is firm (.
- The suspension setting is even firmer (, .
- The vehicle is set to low level.
- The vehicle is not lowered any further if you are traveling at higher speeds.
- 4MATIC+ is more dynamically synchronized.

Differences between different vehicle levels compared to the normal level:

- **High level:** approx. +2.2 in (+55 mm)
- **Low level:** approx. -0.4 in (-10 mm)

When the vehicle is started again, the **COMFORT** setting is activated automatically.

AMG ACTIVE RIDE CONTROL

■ Function of AMG ACTIVE RIDE CONTROL

AMG ACTIVE RIDE CONTROL additionally supplements the functions of AMG RIDE CONTROL +

with an active roll stabilization system. Depending on the selected driving program, the suspension setting is adapted to the driving situation by influencing the vehicle's roll behavior with active stabilizers. As a result, the driving comfort and safety of the vehicle are noticeably improved. The stabilizers on the front and rear axle can also be controlled separately to influence more dynamic handling.

Suspension setting per drive program

Drive program :

- Roll movements are significantly reduced.
- Traction is improved for driving on sand.

Drive program :



- Roll movements are reduced.
- The suspension setting is designed for improved off-road performance.
- Traction is improved for driving off-road and on loose surfaces.

Drive programs  and :

- The lean is reduced during cornering.

- Roll movements caused by uneven road surfaces are compensated for.

Drive programs ,  and :



- The lean is significantly reduced during cornering.
- Roll movements caused by uneven road surfaces are compensated for.
-  and : the driving characteristics become even more agile through targeted interventions.

Drive program :

- Individual settings of the suspension setting via AMG DYNAMICS
 - Basic: reduction of lean during cornering and dynamic handling
 - Advanced: increased reduction of lean during cornering and even more dynamic handling
 - Pro: significantly increased reduction of lean during cornering and the most dynamic handling possible

- Master: significantly increased reduction of lean during cornering and maximum agility in the vehicle's handling through targeted interventions by the system

Selecting the suspension setting

- ⓘ You can also adjust the suspension setting via the multimedia system (→ page 13). In drive programs  and , the suspension setting is permanently assigned and cannot be selected.

You can select from three different suspension settings:

- **COMFORT** ensures a comfortable suspension setting. Select this suspension setting if you prefer a comfortable driving style.
- **SPORT** lowers the vehicle to the lowest level and ensures a firmer suspension setting. Select this suspension setting when employing a sporty driving style, e.g. on winding country roads.
- **SPORT +** lowers the vehicle to the lowest level and ensures a very firm suspension setting.

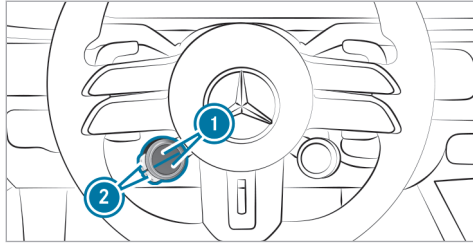



▶ Press upper or lower display button ① repeatedly, until it displays the  symbol.

① If the display button does not show the symbol, then it is hidden. How functions are displayed and the order in which they are displayed can be set in the multimedia system (→ page 8).

▶ Press corresponding button ②.
The selected suspension setting is shown in the driver's display as a message.

The  symbol indicates the currently selected mode:

-  (blue): COMFORT

-  (yellow): SPORT
-  (red): SPORT +

Setting the vehicle level

⚠ WARNING Risk of accident because vehicle level is too high

Driving characteristics may be impaired.

The vehicle can drift outwards, for example, when steering or cornering.

- ▶ Choose a vehicle level which is suited to the driving style and the road surface conditions.

⚠ WARNING Risk of becoming trapped due to the vehicle lowering

When lowering the vehicle, other people could become trapped if their limbs are between the vehicle body and the wheels or underneath the vehicle.

- ▶ Make sure nobody is underneath the vehicle or in the immediate vicinity of the

wheel arches when you lower the vehicle.

⚠ WARNING Risk of becoming trapped due to the vehicle lowering

Vehicles with AMG adaptive sport suspension system+ or level control system: when you unload luggage or leave the vehicle, the vehicle first rises slightly and then returns to the set level shortly afterwards.

You or anyone else in the vicinity of the wheel arches or the underbody could thus become trapped.

The vehicle can also be lowered after being locked.

- ▶ When leaving the vehicle, make sure that nobody is in the vicinity of the wheel arches or the underbody.

Requirements

- The vehicle has been started.
- The vehicle must not be moving faster than 40 mph (65 km/h).

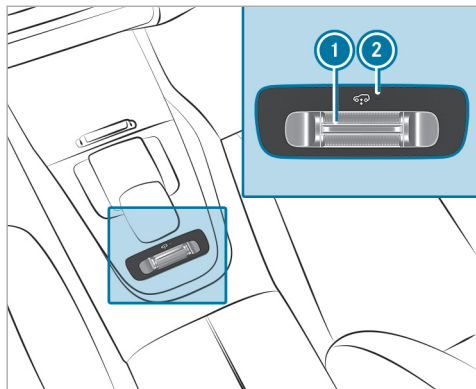

- ▶ **To raise the vehicle:** push rocker switch ① forwards. Indicator lamp ② flashes while the vehicle is being raised and remains lit when the raising process to high or off-road level is complete. The central display shows the selected vehicle level.

Your selection is saved. The high level set remains stored even after the ignition has been switched off.

The vehicle is lowered again to the level of the active drive program in the following situations:

- When driving faster than 50 mph (80 km/h).
- When driving briefly between 40 mph (65 km/h) and 50 mph (80 km/h).
- You select another drive program.

▶ **To lower the vehicle:** pull rocker switch ①. Indicator lamp ② flashes when lowering and goes out when the lowering process to the level of the active drive program is complete. The central display shows the selected vehicle level.

The vehicle sets itself to the standard level of the selected drive program when you switch drive programs.

Operation with a trailer or bicycle rack

If the electrical connection has been correctly established to the trailer or bicycle rack:

- Up to approx. 18.7 mph (30 km/h): the high or off-road level can be selected regardless of drive program.
- From approx. 18.7 mph (30 km/h): the vehicle is adjusted to normal level regardless of drive program.

Notes on the driver's display

⚠ WARNING Risk of accident if the driver display fails

If the driver display has failed or is malfunctioning, function restrictions in systems relevant to safety cannot be detected.

The operating safety of your vehicle may be impaired.

- ▶ Drive on carefully.
- ▶ Have the vehicle checked immediately at a qualified specialist workshop.

The driver's display shows the following basic information:

- Speed, engine speed and power meter level
- Range on map
- Indicator and warning lamps

Additional functions available include the following:

- Different menus, such as Classic
- Status displays for the driving systems

- Display messages

Operating the driver's display

⚠ WARNING Risk of distraction from information systems and communications equipment

If you operate information systems and communication devices integrated in the vehicle when driving, you could be distracted from the traffic situation. This could also cause you to lose control of the vehicle.

- ▶ Only operate this equipment when the traffic situation permits.
- ▶ If you cannot be sure of this, stop the vehicle whilst paying attention to road and traffic conditions and operate the equipment with the vehicle stationary.

Observe the legal requirements for the country in which you are currently driving when operating the driver's display.

Scrolling through the menu bar and calling up a menu

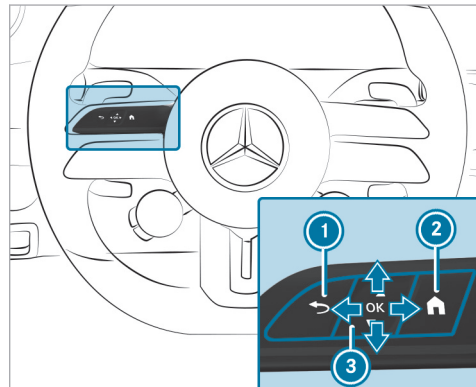

- ① Back button
- ② Main menu
- ③ Touch Control

The content on the driver's display is controlled using the control elements on the left side of the steering wheel. Touch Control ③ is used to navi-

gate in a vertical and horizontal direction by swiping with one finger. Confirm your selection by pressing the Touch Control.

- ① To operate Touch Control ③ in the most effective way, use the tip of your thumb if possible. You can also set the sensitivity of the Touch Control on the central display.
- ▶ Briefly press main menu button ②.
- ▶ Select a menu by swiping to the left or right on Touch Control ③.
- ▶ **To confirm:** press Touch Control ③.

Calling up or exiting the **Options** submenu

- ▶ **To call up:** press left-hand Touch Control ③.
- ▶ **To exit:** press back button ①.

Browsing through display content or lists

- ▶ Swipe up, down, left or right on left-hand Touch Control ③.
- ① For different menus, icons appear at the right edge of the center display area to indicate the current position in a list.

Setting display content as the standard display

You can set custom-configured menu display content as the standard display.

- ▶ Press and hold left-hand Touch Control ③ until the bar display that appears is completely filled. The **Set Shortcut?** prompt will appear.
- ▶ Swipe left on left-hand Touch Control ③ and select **Yes**.
- ▶ **To confirm:** press left-hand Touch Control ③.
- ▶ **To call up standard displays:** press back button ① on the upper level of a menu.
- ① Pressing back button ① on the standard display will call up the previous menu.

Resetting values

- ▶ **To call up the Options submenu:** press left-hand Touch Control ③.
- ▶ **To select the function to be reset:** press left-hand Touch Control ③.
- ▶ Select **Yes**.
- ▶ **To confirm:** press left-hand Touch Control ③.

Driver display menus

Configuring settings on the **Classic** or **Understated** menus (Mercedes-AMG vehicles)

Driver's display:

↳ **Classic**

Selecting display content in the center display area of the **Classic** menu

- ▶ Call up the **Classic** menu via the driver's display menu bar.
- ▶ **To select display content:** swipe upwards or downwards on the left-hand Touch Control and select the desired display content.

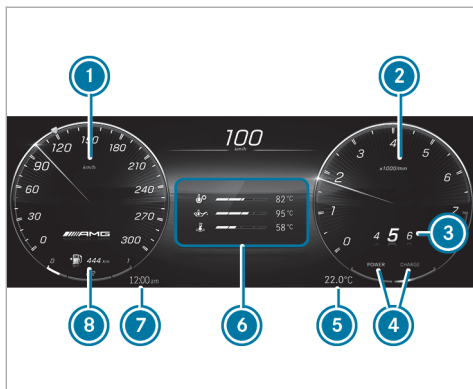

- ① Speedometer
- ② Tachometer
- ③ Gear display
- ④ State of charge of 48 V battery
- ⑤ Outside temperature
- ⑥ Display content, center on the **Classic** menu (example: temperature)

- ⑦ Time
- ⑧ Fuel level and fuel filler flap location indicator

The following display content of the **Classic** menu can be shown in center display area ⑥:

- Trip and total distance
 - Trip computer **From Start** and **From Reset**
 - ECO display
 - Consumption
 - ATTENTION ASSIST
 - Audio
 - Navigation
 - Temperature (transmission oil, engine oil and coolant)
 - Setup
 - Engine data
- ① Depending on the vehicle equipment, AMG-specific content regarding temperature, setup and engine data will be displayed. The settings for the setup display content can be configured either via the buttons on the multi-

function steering wheel or via the MBUX multimedia system (→ page 13).

Selecting the radio station or track on the station or track list

You can select radio stations or tracks on the station or track list in the audio display content of the **Classic** menu.

The following adjustments can be made in the MBUX multimedia system:

- Configuring the station or track list
- Switching between media sources
- Setting the frequency band

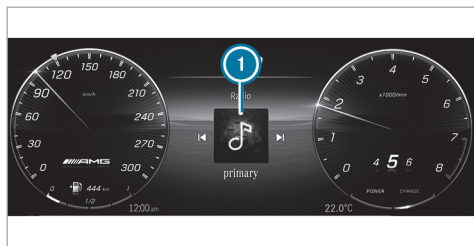

- ① Track list for the audio display content in the center display area (example)
- ▶ **To change radio stations or tracks:** swipe left or right on the left-hand Touch Control and select a radio station or track on station or track list ①.
- ① If you do not carry out any operations immediately after opening station or track list ①, the view will return to the radio station or track selected.
- ① The radio station or title displayed when the vehicle is restarted depends on the user profile used for the previous trip.

Calling up or exiting the **Options** submenu on the **Classic** menu

Depending on the selected display content, you can make changes in the center display area on the **Options** submenu.

- ▶ **To call up the Options submenu:** press the left-hand Touch Control.
- ▶ **To exit the Options submenu:** press the back button .

The following functions may be available on the **Options** submenu, for example:

- Navigation: selecting and adjusting zoom, route guidance and map settings
- Resetting trip distance
- Resetting the trip computer **From Start**
- Resetting the trip computer **From Reset**
- Resetting the ECO display values

Changing color settings on the **Understated** menu

- ▶ Call up the **Understated** menu via the driver's display menu bar.

- ▶ **To call up the color list:** press the left-hand Touch Control.

The color list on the **Understated** menu will appear.

- ▶ **To select color settings:** swipe upwards or downwards on the left-hand Touch Control and select the desired color setting.

- ① If you do not carry out any operations within a limited time after opening the color list, the view will switch back to the default view of the **Understated** menu.

- ▶ **To exit the color list:** press the  back button.

- ① Depending on the equipment, the selected color setting will be adopted for the ambient lighting and the MBUX multimedia system. If you select the **Understated** menu on the driver's display, the content in the MBUX multimedia system will also be made smaller.

Configuring settings on the Supersport menu

Driver's display:

↳ Supersport

- ▶ **To select display content:** swipe upwards or downwards on the left-hand Touch Control.

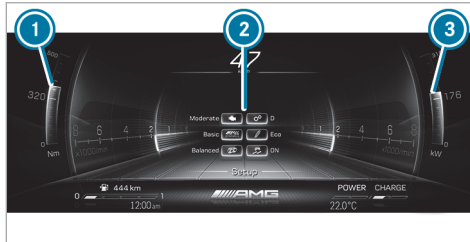

- ① Current torque
- ② Center display content (example: setup)
- ③ Current power output
- i The displays for current torque ① and current power ③ vary depending on the display content in the center display area.

Center display section ② of the Supersport menu shows the following display contents:

- Gear display
- Temperature display (transmission oil, engine oil, coolant)
- Engine data
- Setup
- G-force
- Trip and total distance
- Distance **From Start** and **From Reset**
- Consumption
- Audio
- Navigation
- i Depending on the vehicle equipment, AMG-specific content regarding temperature, setup and engine data will be displayed. The settings for the setup display content can be configured either via the buttons on the multi-function steering wheel or via the MBUX multimedia system (→ page 13).

Calling up the Track Pace menu

Driver's display:

↳ TRACK PACE

The Track Pace function is intended for use on designated race tracks. Do not use this function on public roads, and adapt your driving style to your personal capabilities and the ambient conditions.

The following options will be displayed on the **TRACK PACE** menu:

- G-meter
- Race track selected
- Braking and acceleration procedure
- Gear currently selected



Displays on the Track Pace menu (example)

- ① G-meter
- ② Center display content (example: gear display)
- ③ Telemetry display (example: selected race track)

▶ **To call up the menu:** press the left-hand Touch Control.

The display content of the **TRACK PACE** menu will adapt to the selected settings on the central display:

- Gear display
- Braking points
- Acceleration

- Quarter-miles
- Race track selected on the central display
- Current race
- Record route

While the vehicle is in motion, the G-meter shows the forces that are exerted on the vehicle occupants both laterally and in the direction of travel. The maximum values appear in red in the coordinate system.

Calling up displays on the Sport menu

Driver's display:

➔ Sport

The **Sport** menu displays information about the engine data, the setup and the temperature of the vehicle.

▶ **To call up the menu:** swipe to the left or right on the left-hand Touch Control.

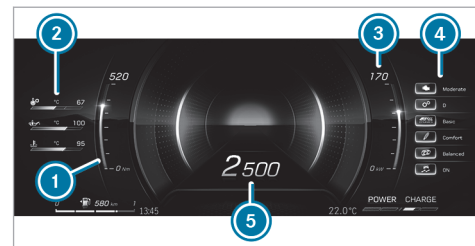

- ① Current torque
- ② Temperature (transmission oil temperature, engine oil temperature, coolant temperature)
- ③ Current power output
- ④ Setup (drive position, transmission position, AMG DYNAMICS, suspension tuning, exhaust system, ESP®)
- ⑤ Engine speed

i Depending on the vehicle equipment, AMG-specific content regarding temperature, setup and engine data will be displayed. The settings for the setup display content can be configured either via the buttons on the multi-function steering wheel or via the MBUX multimedia system (→ page 13). You can also activate or deactivate ESP® using the steering wheel button or via the MBUX multimedia system.

Function of the head-up display

The head-up display projects various content into the driver's field of vision, for example.



You can use the head-up display menu bar to select various contexts, e.g.:

- **Supersport**
- **TRACK PACE**
- Minimal
- Race
- Standard
- ECO display (depending on model and equipment)
- Settings
- Head-up display on/off

Head-up display content with navigation (6x2°)

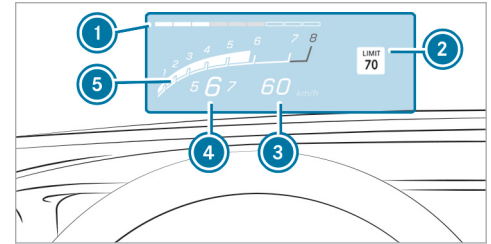

- 1 Protection from reaching the overrewing range
- 2 Detected instructions and traffic signs
- 3 Current speed
- 4 Currently selected gear; gearshift options for manual shifting
- 5 Current engine speed

System limits

Visibility is particularly influenced by the following conditions:





- Seat position

- Image position setting
- Ambient light
- Wet road surfaces
- Objects on the display cover
- Polarization in sunglasses

Overview of status displays on the driver's display (Mercedes-AMG vehicles)

The status displays for the driving and driving safety systems can be found in display sections ① to ⑥.



-  Haptic accelerator pedal
-  HOLD function
-  Slippery road surface warning
-  Engine operating temperature warning lamp (→ page 7)
-  **Display flashes:** vehicle level is being raised or lowered.
- Display is lit up:** vehicle is at high level.

i The number, positions and presentation of the status indicators on the driver's display depend on which systems are activated or deactivated.

Depending on the vehicle equipment, Mercedes-AMG vehicles may have the following status displays, for example:

-  Pedestrian detection (only on assistant display)

AMG TRACK PACE

Function of AMG TRACK PACE

i This function is an on-demand feature and can be activated via Mercedes me after you purchase your vehicle. The Digital Operator's Manual contains further information on Mercedes me and on-demand features.

With AMG TRACK PACE, the driving characteristics on race tracks can be analyzed and optimized. You can drive previously saved race tracks (e.g. Hockenheimring), or record and save new tracks. The driven lap times are stored for every track. These can be analyzed and compared with other lap times to achieve the best possible race results. Additionally, acceleration and braking procedures can be measured and stored.



Note: Use AMG TRACK PACE only on closed-off routes away from public roads. Adapt your driving style to your personal performance and environmental conditions. As the driver, you are solely responsible for driving your vehicle. Park your vehicle safely before operating the application.

Setting Track Race



Multimedia system:

↳ TRACK PACE ▶▶ Track Race

Recording a new track

- ▶ Select  **New Track** .
- ▶ Select  **Start Record**. at the desired starting point.
Track recording will start at this point.

During track recording, sectors can be set to divide up the track.

- ▶  Select **Set Sector**.
- ▶ Select  **Stop Recording** to end track recording or cross the start line again.
- ▶ Confirm the prompt with **Yes**.
- ▶ Select the weather.

i The temperature will be determined automatically.



- ▶ Enter a name.

- ▶ Press **OK** to confirm.
The track will be saved under the name entered.

Searching by track name

- ▶ Select  **Search**.
- ▶ Enter the track name.
Tracks with the name that you have searched for will be displayed.



Measuring time on a saved track

- ▶  Select **All tracks**.
- ▶ Select the desired track.
- ▶ Select .
- ▶ Select **Start Time Recording** if you are already at the start line.

or

- ▶ Select **Navigate to** to navigate to the start line.

Timing will begin automatically when you cross the start line.



- ▶ **i** When  is selected, the track display can be switched to AR. In addition, it is possible to switch to the telemetry display by selecting .

- ▶ Select  **Stop timing** to end timekeeping.
- ▶ Confirm the prompt with **OK**.
- ▶ Select the weather.
- ▶ Select **Yes** to save the times set for this track.

Showing readings during Track Race

The following readings can be shown:

- Tire temperature
- Miniature map
- Sector overview
- Engine data
- G-force display
- Lap overview

- ▶ Select  **Start Time Recording**.
- ▶ Select .

- ▶ Pull the desired display from the grid on the left or right edge of the media display. The readings will be shown during Track Race.

You can deactivate this by selecting  on the active display.

Displaying the analysis

- ▶  Select **All tracks**. An overview of all the tracks you have driven will appear.
- ▶ Select a track.
- ▶ Select a session.

The following data will be displayed:

- Lap and sector times
- Average and top speed
- Driver
- Vehicle
- Date
- Weather
- ▶ Select **Add Recording** to use a different session as a reference value.
- ▶ Select  to return to the overview.

- ▶ Select **Diagram**.
- ▶ Set the desired parameters. The analysis will be displayed.

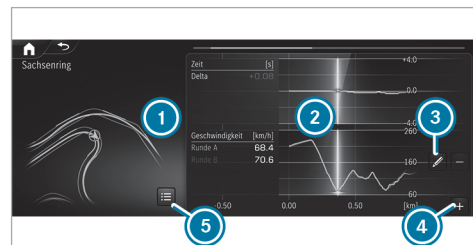



- 1 Lap overview
- 2 Parameter overview
- 3 Editing parameters
- 4 Adding new parameters
- 5 Deleting parameters

- i** The following values can be set for the parameters, for example:
 - Speed
 - Longitudinal/lateral acceleration



- Steering angle
- Engine speed
- Engine oil/tire temperature

Based on the analysis, you can check and optimize the driving behavior for any position on the track.

Exporting tracks (USB)

- ▶ Select  **Tracks** .
An overview of all stored tracks will appear.
- ▶ Select the desired track.
- ▶ Select options  for the desired track.
- ▶ Select **Export Track to...**
The selected track can be exported to a USB storage device connected to the vehicle.

Editing tracks and recordings

- ▶ Select  **Tracks** .
- ▶ Select the desired track.
- ▶ Select options  for the desired track.
- ▶ Select **Rename** or **Delete**.

or

- ▶ Select a track.
- ▶ Highlight the desired recording.
- ▶ Select  options.
- ▶ Select **Export to...** or **Delete**.

Setting Drag Race

Multimedia system:

 **TRACK PACE** ▶▶ **Drag Race**

Measuring acceleration

- ▶ Select  **Drag Race options**.
- ▶ Select **Acceleration**.
- ▶ Set a starting speed or select **Automatic**.
Measurement begins as soon as the specified starting speed has been reached.
- ▶ Set a target speed.
Measurement stops as soon as the specified target speed has been reached.
- ▶ Start off and begin the measurement.
Measurement begins when the vehicle accelerates.

Measurement can be stopped early by interrupting the acceleration procedure.

Quarter mile race

- ▶ Select  **Drag Race options**.
- ▶ Select **Quarter Mile**.
- ▶ Set a target distance.
Measurement stops as soon as the specified target distance has been reached.
- ▶ Start off and begin the measurement.
Measurement begins when the vehicle accelerates. Timing runs until the target distance or a maximum of one mile has been covered.

Measurement can be stopped early by interrupting the acceleration procedure.

Measuring braking

- ▶  **Drag Race options**
- ▶ Select **Braking**.
- ▶ Set a starting speed or select **Automatic**.
- ▶ Start off and begin the measurement.

- ▶ Brake to a standstill. Measurement is incremental, in steps of 6 mph (10 km/h) to a standstill. If the braking procedure is started e.g. at a speed of 98 mph (157 km/h), measurement starts as soon as 93 mph (150 km/h) has been reached.

Storing and calling up measured values

If measurement is completed or canceled, a prompt appears asking whether the measurement should be saved.

- ▶ Confirm the prompt with **OK** to save.

Calling up saved measurements

- ▶ Select  **History**.
- ▶ Select **Acceleration**, **Quarter Mile** or **Braking**.
- ▶ Select a measurement. The desired measurement is displayed in detail.

or

- ▶ Delete a measurement.

Calling up the telemetry display

Multimedia system:

- ▶  **TRACK PACE** ▶▶ **Telemetry**

The telemetry display shows current vehicle data as a digital value and as a diagram. Up to four parameters can be selected to be shown on the display.

For example:

- Engine speed
 - Wheel angle
 - Speed
 - Steering angle
- ▶ Set the desired parameters.
 - ▶ Set the time. The set parameters are evaluated in the diagram for the selected time.

Configuring AMG TRACK PACE

Requirements

To connect a mobile device to the TRACK PACE app:

- The TRACK PACE app is installed on the mobile end device.
- The mobile end device is connected to the multimedia system via Wi-Fi.

Multimedia system:

- ▶  **TRACK PACE** ▶▶ 

Connect mobile device via the TRACK PACE app

The TRACK PACE app makes it possible to record videos and to synchronize them with stored tracks.

- ▶ Select **TRACK PACE App**.
- ▶ Select **Authorize a New Device**.
- ▶ Start the TRACK PACE app on the device to be connected.
- ▶ Select **Next** and confirm the authorization prompt. A four-digit code is shown on the media display.
- ▶ Enter the code on the smartphone. The device is authorized.

De-authorizing the mobile device

- ▶ Select **TRACK PACE App**.
- ▶ Select a device.
- ▶ Confirm the prompt with **Yes**.
The device is de-authorized.

Setting the TRACK PACE display on the head-up display and driver's display

- ▶ Select **IC and HUD Contents**.
- ▶ Activate or deactivate the desired contents.
The contents on the head-up display and the driver's display are adapted.
- ⓘ For further information on the Head-up Display .
- ⓘ Further information about the driver's display .

Setting acoustic feedback

- ▶ Select **Acoustic Feedback**.
A scale with values from 0 to 10 is shown.
- ▶ Select a setting.

Displaying statistics

- ▶ Select **TRACK PACE Statistics**.
Statistics on the current user profile are displayed.
The following data are displayed:
 - Driving time
 - Track driven
 - Recorded tracks
 - Recorded Track Races
 - Laps recorded
 - Recorded Drag Races
 - Maximum design speed

Activating the ambient light

If this function is active, the vehicle interior is lit in red or green depending on delta time.

- ▶ Select **Ambient Light**.
- ▶ Activate or deactivate the function.

Adjusting the dashcam

If the vehicle is equipped with a dashcam, it can be used in AMG TRACK PACE.

- ▶ Select **Dashcam**.
- ▶ Select **Track Race** or **Drag Race** and activate **Activate Recording**.
- ▶ You can set which overlay is to be used in the recorded video under **Video Overlay Content**.

Notes on the care of tailpipes

⚠ WARNING Risk of burns from the tailpipe and tailpipe trims

The exhaust tailpipe and tailpipe trims can become very hot. If you come into contact with these parts of the vehicle, you could burn yourself.

- ▶ Always be particularly careful around the tailpipe and the tailpipe trims and supervise children especially closely in this area.
- ▶ Allow vehicle parts to cool down before touching them.

Observe the following notes in order to prevent damage to the vehicle:

- Clean the tailpipes with a cleaning agent recommended for Mercedes-Benz, especially in the winter and after washing the vehicle.
- Do not use acidic cleaning agents.

Changing a wheel

- ▶ Be sure to also observe the notes on changing a wheel in the Operator's Manual of your vehicle.

Vehicles with AMG Driver's Package:

⚠ WARNING Risk of accident caused by non-approved tire types

If you use tire types that have not been adapted to changes made to the factory speed limit, this can have the following consequences:

- The tires are not suitable for high speeds and the corresponding driving dynamics.
- The tires wear unevenly and affect the roadworthiness of the vehicle.
- ABS, ESP® and cruise control operation are restricted.

This can jeopardize road safety.

- ▶ Only use tire types that have been approved for the maximum permissible speed set and the vehicle.

Vehicles with AMG ceramic high-performance composite braking system:

! NOTE Damage to the ceramic brake disc when changing a wheel

Mercedes-AMG vehicles with ceramic brake discs: during removal and repositioning of the wheel, the wheel rim can strike the ceramic-brake disc and damage it.

- ▶ Take particular care.
- ▶ Ask another person for assistance or use a second alignment bolt.

- ▶ When changing the wheel, avoid exerting any force on the brake disks. This can lead to impaired comfort during braking.

Operating fluids

Fuel

Information on fuel quality for Mercedes-AMG vehicles

Observe the information on operating fluids in the vehicle Operator's Manual.

! NOTE Damage caused by the wrong fuel

Even small amounts of the wrong fuel could result in damage to the fuel system, the engine and the emission control system.

- ▶ Refuel only with low-sulfur spark-ignition engine fuel.

This fuel may contain up to 10% ethanol by volume. Your vehicle is suitable for use with E10 fuel.

Never refuel with one of the following fuels:

- Diesel
- Gasoline with more than 10% ethanol by volume, e.g. E15, E85, E100

- Gasoline with more than 3% methanol by volume, e.g. M15, M30, M85, M100
- Gasoline with metallic additives

If you have accidentally refueled with the wrong fuel:

- ▶ Do not switch on the vehicle.
- ▶ Consult a qualified specialist workshop.

If the available fuel is not sufficiently low in sulfur, it may produce unpleasant odors.

Refuel only with premium-grade unleaded gasoline with an octane number of at least 91 AKI/95 RON.

As a temporary measure, if the recommended fuel is not available, you may also use regular unleaded gasoline. When doing this, note the octane number on the vehicle on the information label on the fuel filler flap (see the vehicle Operator's Manual). Filling up with regular unleaded gasoline can reduce engine output and increase fuel consumption.

Never refuel using gasoline with an even lower RON.

! NOTE Premature engine wear through unleaded regular gasoline

Impairment of the longevity and performance of the engine.

If unleaded premium grade gasoline is unavailable and you have to refuel using unleaded regular gasoline:

- ▶ Only fill the fuel tank to half full with unleaded regular gasoline and refill as soon as possible with unleaded premium grade gasoline.
- ▶ Do not drive at the maximum design speed.
- ▶ Avoid sudden acceleration and engine speeds over 3000 rpm.

Further information on fuel is available in the following locations:

- At a gas station
- At a qualified specialist workshop
- **USA only:** on the <https://www.mbusa.com>

■ Tank content and fuel reserve (Mercedes-AMG vehicles)

Total fuel tank capacity

Model	
Mercedes-AMG GLE 53 4MATIC+ (SUV)	22.5 gal (85.0 liters)
Mercedes-AMG GLE 53 4MATIC+ (Coupe)	

Fuel tank reserve

Model	
Mercedes-AMG GLE 53 4MATIC+ (SUV)	2.3 gal (9.0 liters)
Mercedes-AMG GLE 53 4MATIC+ (Coupe)	

Total fuel tank capacity

Model	
Mercedes-AMG GLE 63 S 4MATIC+ (SUV)	22.5 gal (85.0 liters)
Mercedes-AMG GLE 63 S 4MATIC+ (Coupe)	

Fuel tank reserve

Model	
Mercedes-AMG GLE 63 S 4MATIC+ (SUV)	3.1 gal (12.0 liters)
Mercedes-AMG GLE 63 S 4MATIC+ (Coupe)	

Engine oil quality and filling capacity (Mercedes-AMG vehicles)

Engine oil specifications

Gasoline engines	MB-Freigabe or MB-Approval
Mercedes-AMG GLE 53 4MATIC+ (SUV)	229.51, 229.52, 229.61, 229.71
Mercedes-AMG GLE 53 4MATIC+ (Coupe)	229.72*
Mercedes-AMG GLE 63 S 4MATIC+ (SUV)	229.5
Mercedes-AMG GLE 63 S 4MATIC+ (Coupe)	229.51*

* recommended for lowest possible fuel consumption (lowest SAE viscosity class in each case; observe possible restrictions of the approved SAE viscosity classes)

To achieve the lowest possible fuel consumption, it is recommended to use the engine oil specifications marked in the table with the lowest SAE vis-

cosity class. Possible restrictions of the approved SAE viscosity classes must be observed.

Mercedes-AMG GLE 63 S 4MATIC+ (SUV), Mercedes-AMG GLE 63 S 4MATIC+ (Coupe): use only SAE 0W-40 or SAE 5W-40 motor oils.

The following values refer to an oil change, including the oil filter.

Engine oil filling capacity

Model	Capacity
Mercedes-AMG GLE 53 4MATIC+ (SUV) Mercedes-AMG GLE 53 4MATIC+ (Coupe)	9.0 US qt (8.5 liters)
Mercedes-AMG GLE 63 S 4MATIC+ (SUV) Mercedes-AMG GLE 63 S 4MATIC+ (Coupe)	10.0 US qt (9.5 liters)

Coolant filling capacity (Mercedes-AMG vehicles)

Coolant (engine)

Model	Capacity
Mercedes-AMG GLE 53 4MATIC+ (SUV) Mercedes-AMG GLE 53 4MATIC+ (Coupe)	20.5 US qt (19.4 liters)
Mercedes-AMG GLE 63 S 4MATIC+ (SUV) Mercedes-AMG GLE 63 S 4MATIC+ (Coupe)	17.0 US qt (16.1 liters)

Refrigerant and PAG oil filling quantity (Mercedes-AMG vehicles)

Refrigerant filling quantity

Model	Quantity
Mercedes-AMG GLE 53 4MATIC+ (SUV) Mercedes-AMG GLE 53 4MATIC+ (Coupe)	23.9 ± 0.4 oz (680 ± 10 g)
Mercedes-AMG GLE 63 S 4MATIC+ (SUV) Mercedes-AMG GLE 63 S 4MATIC+ (Coupe)	

Filling quantity for PAG oil

Model	Quantity
Mercedes-AMG GLE 53 4MATIC+ (SUV)	4.9 ± 0.4 oz (140 ± 10 g)
Mercedes-AMG GLE 53 4MATIC+ (Coupe)	
Mercedes-AMG GLE 63 S 4MATIC+ (SUV)	2.8 ± 0.4 oz (80 ± 10 g)
Mercedes-AMG GLE 63 S 4MATIC+ (Coupe)	

Vehicle data

Vehicle dimensions (Mercedes-AMG vehicles)

The heights specified may vary as a result of the following factors:

- Tires
- Load
- Condition of the suspension
- Optional equipment

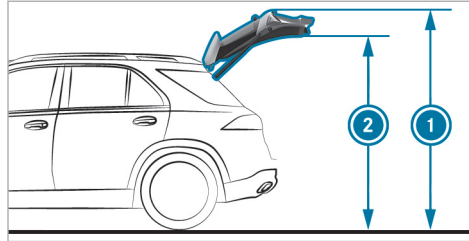

Mercedes-AMG GLE SUV

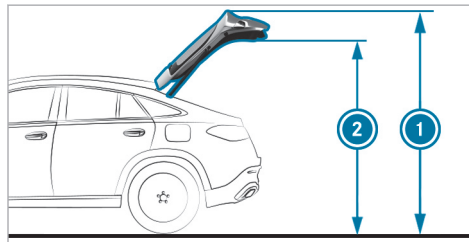

Mercedes-AMG GLE Coupe

Missing values were not available at the time of going to press.

Height when open and height

Model	① Height when opened	② Height
Mercedes-AMG GLE 53 4MATIC+ (SUV)	86.7 in (2203 mm)	77.6 in (1971 mm)
Mercedes-AMG GLE 63 S 4MATIC+ (SUV)	86.7 in (2203 mm)	77.7 in (1973 mm)
Mercedes-AMG GLE 53 4MATIC+ (Coupe)	90.4 in (2297 mm)	77.2 in (1961 mm)
Mercedes-AMG GLE 63 S 4MATIC+ (Coupe)		

Vehicle dimensions

Mercedes-AMG GLE 53 4MATIC+ (SUV)	
Mercedes-AMG GLE 63 S 4MATIC+ (SUV)	
Vehicle length	195.0 in (4954 mm)
Vehicle width including exterior mirrors	84.9 in (2157 mm)
Vehicle height	70.2 in (1782 mm)
Wheelbase	117.9 in (2995 mm)
Turning radius	40.7 ft (12.4 m)
Maximum ground clearance	
Minimum ground clearance	

Vehicle dimensions

Mercedes-AMG GLE 53 4MATIC+ (Coupe)	
Mercedes-AMG GLE 63 S 4MATIC+ (Coupe)	
Vehicle length	195.3 in (4961 mm)
Vehicle width including exterior mirrors	84.9 in (2157 mm)
Vehicle height	67.7 in (1720 mm)
Wheelbase	115.5 in (2935 mm)
Turning radius	40.4 ft (12.3 m)
Maximum ground clearance	
Minimum ground clearance	

Weights (Mercedes-AMG vehicles)

Bear in mind that items of optional equipment increase the curb weight and reduce the payload. Vehicle-specific weight information can be found on the vehicle identification plate.

Off-road driving (Mercedes-AMG vehicles)

Fording depth

! NOTE Damage caused by water when fording

In the following cases water can penetrate into the engine compartment and vehicle interior:

- The maximum permissible fording depth is exceeded when driving through standing water.
- When driving through the water a bow wave forms.
- Water accumulates when driving through running water.

▶ Do not exceed the maximum permissible fording depth and drive slowly through the water.

The specified value indicates the maximum permissible fording depth for vehicles that are in roadworthy condition and for slow driving through standing water.

Driving through flowing water reduces the permissible fording depth due to the accumulation of water.

Observe the notes on off-road driving and fording in the vehicle Operator's Manual.

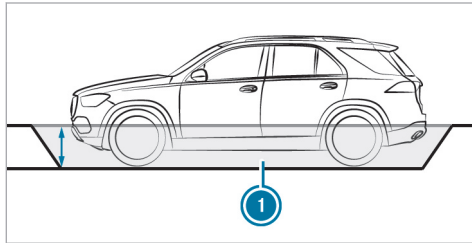

Mercedes-AMG GLE SUV

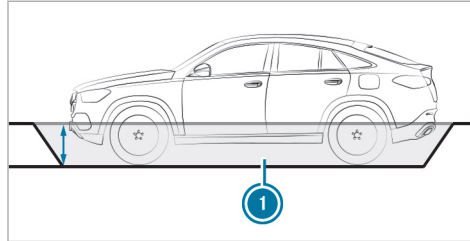

Mercedes-AMG GLE Coupe

Fording depth

Model	1 Fording depth
Mercedes-AMG GLE 53 4MATIC+ (SUV)	19.7 in (50 cm)
Mercedes-AMG GLE 53 4MATIC+ (Coupe)	

Fording depth

Model	1 Fording depth
Mercedes-AMG GLE 63 S 4MATIC+ (SUV)	19.7 in (50 cm)
Mercedes-AMG GLE 63 S 4MATIC+ (Coupe)	

Angle of approach/departure

The specified values are maximum values for vehicles that are in ready-to-drive condition.

Observe the notes on driving in mountainous terrain in the vehicle Operator's Manual.

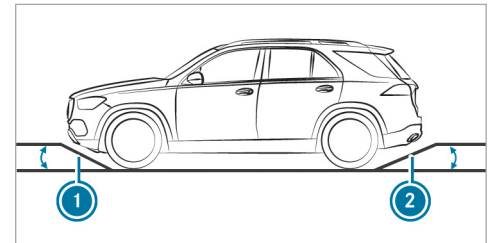

Mercedes-AMG GLE SUV

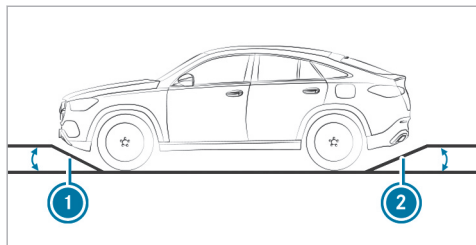

Mercedes-AMG GLE Coupe

Angle of approach/departure

Model	① Angle of approach	② Angle of departure
Mercedes-AMG GLE 53 4MATIC+ (SUV)	21°	20°
Mercedes-AMG GLE 53 4MATIC+ (Coupe)	21°	21°

Model	① Angle of approach	② Angle of departure
Mercedes-AMG GLE 63 S 4MATIC+ (SUV)	18°	20°
Mercedes-AMG GLE 63 S 4MATIC+ (Coupe)	18°	21°

Maximum gradient-climbing ability

The vehicle's gradient-climbing ability depends on the weight distribution in the vehicle, the terrain conditions and the road surface conditions.

The specified value applies in the following cases:

- the vehicle is ready to drive
- the road surface conditions and thus traction are good

A gradient-climbing ability of 100% corresponds to an incline of 45°.

Observe the notes on driving in mountainous terrain in the vehicle Operator's Manual.

Gradient-climbing ability

Model	Maximum gradient-climbing ability
Mercedes-AMG GLE 53 4MATIC+ (SUV)	99%
Mercedes-AMG GLE 53 4MATIC+ (Coupe)	80%
Mercedes-AMG GLE 63 S 4MATIC+ (SUV)	
Mercedes-AMG GLE 63 S 4MATIC+ (Coupe)	

Maximum design speeds

The following values only apply to vehicles with the AMG Driver's Package.

The maximum design speed can differ from the stated figures in practice. It depends on the operating conditions, the optional equipment and the size of the tires.

Missing values were not available at the time of going to press.

Maximum design speed

Model	
Mercedes-AMG GLE 53 4MATIC+ (SUV)	
Mercedes-AMG GLE 53 4MATIC+ (Coupe)	
Mercedes-AMG GLE 63 S 4MATIC+ (SUV)	
Mercedes-AMG GLE 63 S 4MATIC+ (Coupe)	

Trailer hitch

General notes on the trailer hitch

Modifications to the cooling system may be necessary, depending on the vehicle model. Retrofitting a trailer hitch is permissible only if a trailer load is specified in your vehicle documents.

Further information can be obtained at a qualified specialist workshop.

Observe the information and notes on the trailer hitch .

Trailer load (Mercedes-AMG vehicles)

Missing values were not available at the time of going to press.

Towing capacity, braked

Model	Towing capacity, braked
Mercedes-AMG GLE 53 4MATIC+ (SUV)	
Mercedes-AMG GLE 53 4MATIC+ (Coupe)	
Mercedes-AMG GLE 63 S 4MATIC+ (SUV)	
Mercedes-AMG GLE 63 S 4MATIC+ (Coupe)	

Maximum tongue weight and load capacity (Mercedes-AMG vehicles)

! NOTE Damage caused by the trailer coming loose

If the tongue weight used is too low, the trailer may come loose.

- ▶ The tongue weight must not be below 110.2 lbs (50 kg).
- ▶ Use a tongue weight that is as close as possible to the maximum permissible tongue weight.

! **NOTE** Damage caused by the bicycle rack coming loose

When using a bicycle rack, both the maximal tongue weight and the maximal load capacity should be observed.

- ▶ Do not exceed the permissible load capacity.

Missing values were not available at the time of going to press.

Tongue weight

Model	Maximum tongue weight
Mercedes-AMG GLE 53 4MATIC+ (SUV)	
Mercedes-AMG GLE 53 4MATIC+ (Coupe)	
Mercedes-AMG GLE 63 S 4MATIC+ (SUV)	
Mercedes-AMG GLE 63 S 4MATIC+ (Coupe)	

Load capacity

All models	Maximum load capacity
When the bicycle rack is attached to the ball head	165.3 lbs (75 kg)
When the bicycle rack is attached to the ball head and additionally to the guide pin	220.5 lbs (100 kg)

Display messages



Driving and driving safety systems

Display messages	Possible causes/consequences and ► Solutions
 <p data-bbox="195 422 473 474">Malfunction Do Not Exceed 50 mph</p>	<ul style="list-style-type: none"> <li data-bbox="526 332 1681 381">* AMG RIDE CONTROL + or AMG ACTIVE RIDE CONTROL is malfunctioning. The vehicle's handling characteristics may be affected. <ul style="list-style-type: none"> <li data-bbox="545 391 920 417">► Do not exceed 50 mph (80 km/h). <li data-bbox="545 425 964 451">► Consult a qualified specialist workshop.
<p data-bbox="195 498 473 576">AMG Ride Control Function Limited See Operator's Manual</p>	<ul style="list-style-type: none"> <li data-bbox="526 498 1626 591">* At least one of the main functions of AMG RIDE CONTROL + or AMG ACTIVE RIDE CONTROL is malfunctioning. The system is outside the operating temperature range or the on-board electrical system voltage is too low. Once the cause of the problem is no longer present, the system will be available again. <div style="border: 1px solid black; padding: 5px; margin-top: 10px;"> <p data-bbox="559 619 1641 671">! NOTE The vehicle's suspension and damping behavior is restricted. The vehicle body may tilt heavily to the side during cornering.</p> <ul style="list-style-type: none"> <li data-bbox="559 686 772 712">► Drive on carefully. <li data-bbox="559 721 1079 746">► Reduce speed considerably before taking a bend. <li data-bbox="559 755 938 781">► Avoid sudden steering movements. </div> <ul style="list-style-type: none"> <li data-bbox="545 809 757 835">► Drive on carefully. <li data-bbox="545 843 1062 869">► Reduce speed considerably before taking a bend.

Display messages	Possible causes/consequences and ► Solutions
	<p>► Avoid sudden steering movements.</p>

Warning and indicator lamps

Driving and driving safety systems

Warning/indicator lamp	Possible causes/consequences and ► Solutions
 <p>Suspension warning lamp (yellow)</p>	<p>* The yellow AMG RIDE CONTROL + or AMG ACTIVE RIDE CONTROL warning lamp is lit. There is a malfunction in the AMG RIDE CONTROL + or the AMG ACTIVE RIDE CONTROL.</p> <p>► Note the messages on the driver's display.</p>
	<p>* The yellow ESP[®] OFF warning lamps are lit while the vehicle is running. ESP[®] is deactivated.</p> <p>Other driving systems and driving safety systems may also be inoperative.</p> <div style="background-color: #e0e0e0; padding: 5px;"> <p>⚠ WARNING Risk of skidding when driving with ESP[®] deactivated</p> </div> <p>ESP[®] does not act to stabilize the vehicle. The availability of further driving safety systems is also limited.</p>

Warning/indicator lamp	Possible causes/consequences and ► Solutions
	<ul style="list-style-type: none"> ► Drive on carefully. ► Deactivate ESP® only for as long as the situation requires. <p>If ESP® cannot be activated, ESP® is malfunctioning.</p> <ul style="list-style-type: none"> ► Have ESP® checked immediately at a qualified specialist workshop. <p>► Observe the notes on deactivating ESP® (→ page 15).</p>
	<p>* ESP® SPORT is activated while the vehicle is running. When ESP® SPORT is activated, ESP® will stabilize the vehicle only to a limited extent.</p> <p>▲ WARNING Risk of skidding if ESP® SPORT is used incorrectly</p> <p>When you activate ESP® SPORT, there is an increased risk of skidding and having an accident.</p> <ul style="list-style-type: none"> ► Activate ESP® SPORT only in the circumstances described below. <p>► Observe the notes on activating ESP® SPORT(→ page 15).</p>

A			
AMG active adaptive sport suspension system			
Selecting the suspension setting.....	20		
AMG ACTIVE RIDE CONTROL			
Function.....	19		
Setting the vehicle level.....	21		
AMG ceramic high-performance composite brake system	10		
AMG DYNAMIC SELECT			
Setting drive programs.....	13		
AMG Real Performance Sound	9		
AMG RIDE CONTROL +			
Function.....	18		
AMG steering wheel buttons			
Setting.....	8		
AMG steering-wheel buttons			
Function.....	7		
AMG TRACK PACE			
Configuring.....	34		
Drag Race.....	33		
Function.....	31		
Telemetry display.....	34		
		Track Race.....	31
		Automatic transmission	
		Drive programs.....	10
		DYNAMIC SELECT button.....	10
		Manual gear shifting.....	13
		Oil temperature (driver's display).....	28
		Steering wheel paddle shifters.....	13
B			
		Bicycle rack	
		Load capacity.....	45
		Boost pressure, current (driver's display)	28
		Brakes	
		AMG ceramic high-performance composite brake system.....	10
C			
		Care	
		Tailpipes.....	36
		Classic menu display content	
		Selecting.....	24
		Climate control	
		Filling capacity for refrigerant and PAG oil.....	40
		Cockpit	
		Instrument panel.....	4
		Coolant	
		Capacity.....	40
D			
		DIRECT SELECT lever	
		Manual gearshifting.....	13
		Display (driver's display)	
		Overview of displays.....	30
		Display messages	
		 Malfunction Do Not Exceed 50 mph	47
		AMG Ride Control Function Limited	
		See <i>Operator's Manual</i>	47
		Drag Race	33
		Drive program display	11
		Drive programs	
		AMG DYNAMIC SELECT.....	13

Selecting.....	11		
Driver display , Instrument cluster			
Function/notes.....	23		
Track Pace menu.....	27		
Driver's display			
Classic menu.....	24		
Head-up display.....	29		
Operating.....	23		
Status displays.....	30		
Supersport menu.....	27		
Understated menu.....	24		
Driving safety system			
ESP® (Electronic Stability Program).....	15		
Driving system			
AMG RIDE CONTROL +.....	18		
Driving tips			
AMG ceramic high-performance composite brake system.....	10		
DYNAMIC SELECT			
Drive program display.....	11		
Drive programs.....	10		
Function.....	10		
Selecting the drive program.....	11		
		E	
E10	38		
ECO start/stop button			
Automatic engine start/stop.....	9		
ECO start/stop function			
Switching off/on.....	9		
Electronic Stability Program	15		
Emotion Start	8		
Engine oil			
Capacity.....	39		
MB-Freigabe or MB-Approval.....	39		
Quality.....	39		
Temperature (driver's display).....	28		
Engine oil temperature (driver's display)	28		
Engine operating temperature			
Warning lamp.....	7		
Engine output	7		
Engine output, current (driver's display)	28		
Engine sound	9		
Engine torque	7		
			ESP®
			Activating/deactivating.....
			ESP® SPORT.....
			Function.....
			Setting (steering-wheel button).....
		F	
		Fuel	
		E10.....	38
		Flexible fuel vehicles.....	38
		Gasoline.....	38
		Gasoline quality.....	38
		Reserve.....	39
		Sulfur content.....	38
		Tank capacity.....	39
		Fuel reserve	39
		G	
		G-meter , Accelerometer.....	28
		Gasoline	38
		Gearshift	
		Manual.....	13
		Glide mode	15

- H**
- Head-up display
 - Function..... 29
- I**
- Installing
 - Tires/wheels..... 37
 - Instrument panel
 - Cockpit..... 4
- L**
- Level control
 - AMG RIDE CONTROL +..... 18
 - Load capacity
 - Bicycle rack..... 45
 - Lowered suspension
 - AMG ACTIVE RIDE CONTROL..... 19
- M**
- Manual gearshifting
 - Activating/deactivating..... 14
 - Maximum permissible speed (Mercedes-AMG vehicles)..... 44
- Menu (driver display)**
Track Pace..... 27
- Menu (driver's display)**
Classic menu..... 24
Sport..... 28
Supersport..... 27
Understated menu..... 24
- O**
- Operating fluids
 - Gasoline..... 38
 - Operator's manual..... 6
- P**
- Paddle shifters
 - Steering wheel paddle shifters..... 13
 - Programs..... 10
- R**
- Racetrack mode
 - AMG ceramic high-performance composite brake system..... 10
 - AMG steering-wheel buttons..... 7
 - Reserve
 - Fuel..... 39
 - Rocking free..... 13
- S**
- Selecting a gear..... 13
 - Selecting a sound characteristic (steering-wheel button)..... 9
 - Setting the suspension level..... 21
 - Shifting
 - Automatic transmission..... 13
 - Manual..... 13
 - Steering wheel paddle shifters..... 13
 - Sound
 - AMG Real Performance Sound..... 9
 - Start/stop button
 - Emotion Start..... 8
 - Steering wheel paddle shifters..... 13
 - Stop and go
 - ECO start/stop function..... 9
 - Sulfur content..... 38

Supersport menu display content			
Selecting.....	27		
Suspension			
AMG ACTIVE RIDE CONTROL.....	19		
AMG RIDE CONTROL +.....	18		
Selecting the suspension setting.....	20		
Setting the vehicle level.....	21		
T			
Tailpipes			
Care.....	36		
Tank capacity			
Fuel.....	39		
Reserve.....	39		
Technical data			
Maximum permissible speed Maxi-			
mum permissible speed (Mercedes-			
AMG vehicles).....	44		
Tongue weight.....	45		
Towing capacity.....	45		
Vehicle dimensions.....	41		
Telemetry display	34		
Tires			
Installing.....	37		
		Removing.....	37
		Tongue weight	45
		Torque (driver's display)	28
		Touch Control	
		Driver's display.....	23
		Track Pace	
		Menu (driver display).....	27
		Track Race	31
		Trailer hitch	
		General notes.....	45
		Tongue weight.....	45
		Towing capacity.....	45
U			
		Understated menu display content	
		Selecting.....	24
V			
		vehicle	
		Emotion Start.....	8
		Equipment.....	6
		Rocking free.....	13
		Vehicle data	
		Angle of approach/departure.....	42
		Fording depth.....	42
		Maximum gradient-climbing capability.....	42
		Maximum permissible speed	
		(Mercedes-AMG vehicles).....	44
		Turning circle.....	41
		Vehicle height.....	41
		Vehicle length.....	41
		Vehicle width.....	41
		Weights.....	42
		Wheelbase.....	41
		Vehicle dimensions	41
		Vehicle equipment	6
W			
		Warning/indicator lamp	
		 Suspension warning lamp (yellow)..	48
		Wheel change	
		Installing a new wheel.....	37
		Removing a wheel.....	37
		Wheels	
		Installing.....	37
		Removing.....	37





